



Victor W.
RODWELL

David A.
BENDER

Kathleen M.
BOTHAM

Peter J.
KENNELLY

P. Anthony
WEIL

31ST EDITION

HARPER'S
ILLUSTRATED
BIOCHEMISTRY

Mc
Graw
Hill
Education

LANGGE[®]

a LANGE medical book

Harper's Illustrated Biochemistry

THIRTY-FIRST EDITION

Victor W. Rodwell, PhD

*Professor (Emeritus) of Biochemistry
Purdue University
West Lafayette, Indiana*

David A. Bender, PhD

*Professor (Emeritus) of Nutritional Biochemistry
University College London
London, United Kingdom*

Kathleen M. Botham, PhD, DSc

*Professor (Emeritus) of Biochemistry
Department of Comparative Biomedical Sciences
Royal Veterinary College
University of London
London, United Kingdom*

Peter J. Kennelly, PhD

*Professor
Department of Biochemistry
Virginia Tech
Blacksburg, Virginia*

P. Anthony Weil, PhD

*Professor
Department of Molecular Physiology & Biophysics
Vanderbilt University
Nashville, Tennessee*



New York Chicago San Francisco Athens London Madrid Mexico City
Milan New Delhi Singapore Sydney Toronto

Copyright © 2018 by McGraw-Hill Education. All rights reserved. Except as permitted under the United States Copyright Act of 1976, no part of this publication may be reproduced or distributed in any form or by any means, or stored in a database or retrieval system, without the prior written permission of the publisher.

ISBN: 978-1-25-983794-4

MHID: 1-25-983794-7

The material in this eBook also appears in the print version of this title:

ISBN: 978-1-25-983793-7,

MHID: 1-25-983793-9.

eBook conversion by codeMantra

Version 1.0

All trademarks are trademarks of their respective owners. Rather than put a trademark symbol after every occurrence of a trademarked name, we use names in an editorial fashion only, and to the benefit of the trademark owner, with no intention of infringement of the trademark. Where such designations appear in this book, they have been printed with initial caps.

McGraw-Hill Education eBooks are available at special quantity discounts to use as premiums and sales promotions or for use in corporate training programs. To contact a representative, please visit the Contact Us page at www.mhprofessional.com.

Notice

Medicine is an ever-changing science. As new research and clinical experience broaden our knowledge, changes in treatment and drug therapy are required. The authors and the publisher of this work have checked with sources believed to be reliable in their efforts to provide information that is complete and generally in accord with the standards accepted at the time of publication. However, in view of the possibility of human error or changes in medical sciences, neither the authors nor the publisher nor any other party who has been involved in the preparation or publication of this work warrants that the information contained herein is in every respect accurate or complete, and they disclaim all responsibility for any errors or omissions or for the results obtained from use of the information contained

in this work. Readers are encouraged to confirm the information contained herein with other sources. For example and in particular, readers are advised to check the product information sheet included in the package of each drug they plan to administer to be certain that the information contained in this work is accurate and that changes have not been made in the recommended dose or in the contraindications for administration. This recommendation is of particular importance in connection with new or infrequently used drugs.

TERMS OF USE

This is a copyrighted work and McGraw-Hill Education and its licensors reserve all rights in and to the work. Use of this work is subject to these terms. Except as permitted under the Copyright Act of 1976 and the right to store and retrieve one copy of the work, you may not decompile, disassemble, reverse engineer, reproduce, modify, create derivative works based upon, transmit, distribute, disseminate, sell, publish or sublicense the work or any part of it without McGraw-Hill Education's prior consent. You may use the work for your own noncommercial and personal use; any other use of the work is strictly prohibited. Your right to use the work may be terminated if you fail to comply with these terms.

THE WORK IS PROVIDED "AS IS." MCGRAW-HILL EDUCATION AND ITS LICENSORS MAKE NO GUARANTEES OR WARRANTIES AS TO THE ACCURACY, ADEQUACY OR COMPLETENESS OF OR RESULTS TO BE OBTAINED FROM USING THE WORK, INCLUDING ANY INFORMATION THAT CAN BE ACCESSED THROUGH THE WORK VIA HYPERLINK OR OTHERWISE, AND EXPRESSLY DISCLAIM ANY WARRANTY, EXPRESS OR IMPLIED, INCLUDING BUT NOT LIMITED TO IMPLIED WARRANTIES OF MERCHANTABILITY OR FITNESS FOR A PARTICULAR PURPOSE. McGraw-Hill Education and its licensors do not warrant or guarantee that the functions contained in the work will meet your requirements or that its operation will be uninterrupted or error free. Neither McGraw-Hill Education nor its licensors shall be liable to you or anyone else for any inaccuracy, error or omission, regardless of cause, in the work or for any damages resulting therefrom. McGraw-Hill Education has no responsibility for the content of any information accessed through the work. Under no circumstances shall McGraw-Hill Education and/or its licensors be liable for any indirect, incidental, special, punitive,

consequential or similar damages that result from the use of or inability to use the work, even if any of them has been advised of the possibility of such damages. This limitation of liability shall apply to any claim or cause whatsoever whether such claim or cause arises in contract, tort or otherwise.

Coauthors

Peter L. Gross, MD, MSc, FRCP(C)

Associate Professor
Department of Medicine
McMaster University
Hamilton, Ontario, Canada

Molly Jacob MD, PhD

Professor and Head
Department of Biochemistry
Christian Medical College
Bagayam, Vellore, Tamil Nadu, India

Peter A. Mayes, PhD, DSc

Professor (Emeritus) of Veterinary Biochemistry
Royal Veterinary College
University of London
London, United Kingdom

Robert K. Murray, MD, PhD

Professor (Emeritus) of Biochemistry
University of Toronto
Toronto, Ontario, Canada

Margaret L. Rand, PhD

Senior Associate Scientist
Division of Haematology/Oncology
Hospital for Sick Children, Toronto, and Professor

Department of Biochemistry
University of Toronto, Toronto, Canada

Joe Varghese, PhD

Professor
Department of Biochemistry
Christian Medical College
Bagayam, Vellore, Tamil Nadu, India

Contents

Preface

SECTION

I

Structures & Functions of Proteins & Enzymes

1 Biochemistry & Medicine

Victor W. Rodwell, PhD, & Robert K. Murray, MD, PhD

2 Water & pH

Peter J. Kennelly, PhD & Victor W. Rodwell, PhD

3 Amino Acids & Peptides

Peter J. Kennelly, PhD & Victor W. Rodwell, PhD

4 Proteins: Determination of Primary Structure

Peter J. Kennelly, PhD & Victor W. Rodwell, PhD

5 Proteins: Higher Orders of Structure

Peter J. Kennelly, PhD & Victor W. Rodwell, PhD

SECTION

Enzymes: Kinetics, Mechanism,

II

Regulation, & Role of Transition Metals

6 Proteins: Myoglobin & Hemoglobin

Peter J. Kennelly, PhD & Victor W. Rodwell, PhD

7 Enzymes: Mechanism of Action

Peter J. Kennelly, PhD & Victor W. Rodwell, PhD

8 Enzymes: Kinetics

Victor W. Rodwell, PhD

9 Enzymes: Regulation of Activities

Peter J. Kennelly, PhD & Victor W. Rodwell, PhD

10 The Biochemical Roles of Transition Metals

Peter J. Kennelly, PhD

SECTION

III

Bioenergetics

11 Bioenergetics: The Role of ATP

Kathleen M. Botham, PhD, DSc & Peter A. Mayes, PhD, DSc

12 Biologic Oxidation

Kathleen M. Botham, PhD, DSc & Peter A. Mayes, PhD, DSc

13 The Respiratory Chain & Oxidative Phosphorylation

Kathleen M. Botham, PhD, DSc & Peter A. Mayes, PhD, DSc

SECTION

IV

Metabolism of Carbohydrates

14 Overview of Metabolism & the Provision of Metabolic Fuels

David A. Bender, PhD & Peter A. Mayes, PhD, DSc

15 Carbohydrates of Physiological Significance

David A. Bender, PhD & Peter A. Mayes, PhD, DSc

16 The Citric Acid Cycle: The Central Pathway of Carbohydrate, Lipid, & Amino Acid Metabolism

David A. Bender, PhD & Peter A. Mayes, PhD, DSc

17 Glycolysis & the Oxidation of Pyruvate

David A. Bender, PhD & Peter A. Mayes, PhD, DSc

18 Metabolism of Glycogen

David A. Bender, PhD & Peter A. Mayes, PhD, DSc

19 Gluconeogenesis & the Control of Blood Glucose

David A. Bender, PhD & Peter A. Mayes, PhD, DSc

20 The Pentose Phosphate Pathway & Other Pathways of Hexose Metabolism

David A. Bender, PhD & Peter A. Mayes, PhD, DSc

SECTION

V

Metabolism of Lipids

21 Lipids of Physiologic Significance

Kathleen M. Botham, PhD, DSc & Peter A. Mayes, PhD, DSc

- 22** Oxidation of Fatty Acids: Ketogenesis
Kathleen M. Botham, PhD, DSc & Peter A. Mayes, PhD, DSc
- 23** Biosynthesis of Fatty Acids & Eicosanoids
Kathleen M. Botham, PhD, DSc & Peter A. Mayes, PhD, DSc
- 24** Metabolism of Acylglycerols & Sphingolipids
Kathleen M. Botham, PhD, DSc & Peter A. Mayes, PhD, DSc
- 25** Lipid Transport & Storage
Kathleen M. Botham, PhD, DSc & Peter A. Mayes, PhD, DSc
- 26** Cholesterol Synthesis, Transport, & Excretion
Kathleen M. Botham, PhD, DSc & Peter A. Mayes, PhD, DSc

SECTION

VI

Metabolism of Proteins & Amino Acids

- 27** Biosynthesis of the Nutritionally Nonessential Amino Acids
Victor W. Rodwell, PhD
- 28** Catabolism of Proteins & of Amino Acid Nitrogen
Victor W. Rodwell, PhD
- 29** Catabolism of the Carbon Skeletons of Amino Acids
Victor W. Rodwell, PhD
- 30** Conversion of Amino Acids to Specialized Products
Victor W. Rodwell, PhD
- 31** Porphyrins & Bile Pigments
Victor W. Rodwell, PhD & Robert K. Murray, MD, PhD

SECTION
VII

Structure, Function, & Replication of
Informational Macromolecules

32 Nucleotides

Victor W. Rodwell, PhD

33 Metabolism of Purine & Pyrimidine Nucleotides

Victor W. Rodwell, PhD

34 Nucleic Acid Structure & Function

P. Anthony Weil, PhD

35 DNA Organization, Replication, & Repair

P. Anthony Weil, PhD

36 RNA Synthesis, Processing, & Modification

P. Anthony Weil, PhD

37 Protein Synthesis & the Genetic Code

P. Anthony Weil, PhD

38 Regulation of Gene Expression

P. Anthony Weil, PhD

39 Molecular Genetics, Recombinant DNA, & Genomic
Technology

P. Anthony Weil, PhD

SECTION
VIII

Biochemistry of Extracellular &
Intracellular Communication

40 Membranes: Structure & Function

P. Anthony Weil, PhD

41 The Diversity of the Endocrine System

P. Anthony Weil, PhD

42 Hormone Action & Signal Transduction

P. Anthony Weil, PhD

SECTION

IX

Special Topics (A)

43 Nutrition, Digestion, & Absorption

David A. Bender, PhD & Peter A. Mayes, PhD, DSc

44 Micronutrients: Vitamins & Minerals

David A. Bender, PhD

45 Free Radicals & Antioxidant Nutrients

David A. Bender, PhD

46 Glycoproteins

David A. Bender, PhD & Robert K. Murray, MD, PhD

47 Metabolism of Xenobiotics

David A. Bender, PhD & Robert K. Murray, MD, PhD

48 Clinical Biochemistry

David A. Bender, PhD & Robert K. Murray, MD, PhD

SECTION

X

Special Topics (B)

49 Intracellular Traffic & Sorting of Proteins

Kathleen M. Botham, PhD, DSc & Robert K. Murray, MD, PhD

50 The Extracellular Matrix

Kathleen M. Botham, PhD, DSc & Robert K. Murray, MD, PhD

51 Muscle & the Cytoskeleton

Peter J. Kennelly, PhD and Robert K. Murray, MD, PhD

52 Plasma Proteins & Immunoglobulins

Peter J. Kennelly, PhD, Robert K. Murray, MD, PhD, Molly Jacob, MBBS, MD, PhD & Joe Varghese, MBBS, MD

53 Red Blood Cells

Peter J. Kennelly, PhD & Robert K. Murray, MD, PhD

54 White Blood Cells

Peter J. Kennelly, PhD & Robert K. Murray, MD, PhD

SECTION

XI

Special Topics (C)

55 Hemostasis & Thrombosis

Peter L. Gross, MD, MSc, FRCP(C), P. Anthony Weil, PhD & Margaret L. Rand, PhD

56 Cancer: An Overview

Molly Jacob, MD, PhD, Joe Varghese, PhD & P. Anthony Weil, PhD

57 The Biochemistry of Aging

Peter J. Kennelly, PhD

58 Biochemical Case Histories

David A. Bender, PhD

The Answer Bank

Index

Preface

The authors and publishers are pleased to present the thirty-first edition of *Harper's Illustrated Biochemistry*. The first edition, entitled *Harper's Biochemistry*, was published in 1939 under the sole authorship of Dr Harold Harper at the University of California School of Medicine, San Francisco, California. Presently entitled *Harper's Illustrated Biochemistry*, the book continues, as originally intended, to provide a concise survey of aspects of biochemistry most relevant to the study of medicine. Various authors have contributed to subsequent editions of this medically oriented biochemistry text, which is now observing its 79th year.

Cover Illustration for the Thirty-first Edition

The illustration on the cover of the thirty-first edition, the structure of Zika virus protein determined at 3.8 Å resolution, was generously prepared and provided by Lei Sun. The supporting data appeared in: Sirohi D, Chen Z, Sun L, Klose T, Pierson TC, Rossmann MG, Kuhn RJ: "The 3.8 Å resolution cryo-EM structure of Zika virus protein", *Science* 2016;352:497-470. Together with the Zika virus, first recovered in the Zika valley of Uganda, the viruses responsible for yellow fever, West Nile fever, and dengue fever are members of the *Flaviviridae* family of positive-strand DNA viruses. The cover illustration indicates the resolving power of cryo-electron microscopy (cryo-EM). More importantly, it recognizes the medical significance of infection by the Zika virus, which in pregnant women can result in a significant risk of congenital microcephaly and associated severe mental impairment. While Zika virus typically is transmitted by the bite of an infected mosquito, emerging evidence suggests that under certain conditions the Zika virus may also be transmitted between human subjects.

Changes in the Thirty-first Edition

As always, *Harper's Illustrated Biochemistry* continues to emphasize the close relationship of biochemistry to the understanding of diseases, their pathology and the practice of medicine. The contents of most chapters have been updated and provide to the reader the most current and pertinent information. Toward that end, we have replaced [Chapter 10](#) "Bioinformatics and Computational Biology," most of whose programs and topics (for example protein and nucleotide sequence comparisons and *in silico* approaches in drug design) are available on line or are now common knowledge. Its replacement, new [Chapter 10](#) "Biochemistry of Transition Metals," incorporates material from several chapters, notably those of blood cells and plasma, which contained extensive content on metal ion adsorption and trafficking, especially of iron and copper. Since approximately a third of all proteins are metalloproteins, new [Chapter 10](#) explicitly addresses the importance and overall pervasiveness of transition metals. Given the overlap with the topics of protein structure and of enzyme reaction mechanisms, new [Chapter 10](#) now follows the three chapters on enzymes as the final chapter in [Section II](#), now renamed Enzymes: Kinetics, Mechanism, Regulation, & Role of Transition Metals.

Organization of the Book

All 58 chapters of the thirty-first edition place major emphasis on the medical relevance of biochemistry. Topics are organized under eleven major headings. Both to assist study and to facilitate retention of the contained information, Questions follow each Section. An Answer Bank follows the Appendix.

[Section I](#) includes a brief history of biochemistry, and emphasizes the interrelationships between biochemistry and medicine. Water, the importance of homeostasis of intracellular pH are reviewed, and the various orders of protein structure are addressed.

[Section II](#) begins with a chapter on hemoglobin. Four chapters next address the kinetics, mechanism of action, and metabolic regulation of enzymes, and the role of metal ions in multiple aspects of intermediary metabolism.

[Section III](#) addresses bioenergetics and the role of high energy phosphates in energy capture and transfer, the oxidation–reduction reactions involved in biologic oxidation, and metabolic details of energy capture via the respiratory chain and oxidative phosphorylation.

[Section IV](#) considers the metabolism of carbohydrates via glycolysis, the citric acid cycle, the pentose phosphate pathway, glycogen

metabolism, gluconeogenesis, and the control of blood glucose.

Section V outlines the nature of simple and complex lipids, lipid transport and storage, the biosynthesis and degradation of fatty acids and more complex lipids, and the reactions and metabolic regulation of cholesterol biosynthesis and transport in human subjects.

Section VI discusses protein catabolism, urea biosynthesis, and the catabolism of amino acids and stresses the medically significant metabolic disorders associated with their incomplete catabolism. The final chapter considers the biochemistry of the porphyrins and bile pigments.

Section VII first outlines the structure and function of nucleotides and nucleic acids, then details DNA replication and repair, RNA synthesis and modification, protein synthesis, the principles of recombinant DNA technology, and the regulation of gene expression.

Section VIII considers aspects of extracellular and intracellular communication. Specific topics include membrane structure and function, the molecular bases of the actions of hormones, and signal transduction.

Sections IX, X, & XI address fourteen topics of significant medical importance.

Section IX discusses nutrition, digestion, and absorption, micronutrients including vitamins free radicals and antioxidants, glycoproteins, the metabolism of xenobiotics, and clinical biochemistry.

Section X addresses intracellular traffic and the sorting of proteins, the extracellular matrix, muscle and the cytoskeleton, plasma proteins and immunoglobulins, and the biochemistry of red cells and of white cells.

Section XI includes hemostasis and thrombosis, an overview of cancer, the biochemistry of aging, and a selection of case histories.

Acknowledgments

The authors thank Michael Weitz for his role in the planning of this edition and Peter Boyle for overseeing its preparation for publication. We also thank Surbhi Mittal and Jyoti Shaw at Cenveo Publisher Services for their efforts in managing editing, typesetting, and artwork. We gratefully acknowledge numerous suggestions and corrections received from students and colleagues from around the world, especially those of Dr. Karthikeyan Pethusamy of the All India Institute of Medical Sciences, New Delhi, India.

Victor W. Rodwell
David A. Bender
Kathleen M. Botham
Peter J. Kennelly
P. Anthony Weil

SECTION

I

Structures & Functions of Proteins & Enzymes

CHAPTER

1

Biochemistry & Medicine

Victor W. Rodwell, PhD, & Robert K. Murray, MD, PhD

OBJECTIVES

After studying this chapter, you should be able to:

- Understand the importance of the ability of cell-free extracts of yeast to ferment sugars, an observation that enabled discovery of the intermediates of fermentation, glycolysis, and other metabolic pathways.
- Appreciate the scope of biochemistry and its central role in the life sciences, and that biochemistry and medicine are intimately related disciplines.
- Appreciate that biochemistry integrates knowledge of the chemical processes in living cells with strategies to maintain health,

understand disease, identify potential therapies, and enhance our understanding of the origins of life on earth.

- Describe how genetic approaches have been critical for elucidating many areas of biochemistry, and how the Human Genome Project has furthered advances in numerous aspects of biology and medicine.

BIOMEDICAL IMPORTANCE

Biochemistry and medicine enjoy a mutually cooperative relationship. Biochemical studies have illuminated many aspects of health and disease, and the study of various aspects of health and disease has opened up new areas of biochemistry. The medical relevance of biochemistry both in normal and abnormal situations is emphasized throughout this book. Biochemistry makes significant contributions to the fields of cell biology, physiology, immunology, microbiology, pharmacology, toxicology, and epidemiology, as well as the fields of inflammation, cell injury, and cancer. These close relationships emphasize that life, as we know it, depends on biochemical reactions and processes.

DISCOVERY THAT A CELL-FREE EXTRACT OF YEAST CAN FERMENT SUGAR

Although the ability of yeast to “ferment” various sugars to ethyl alcohol has been known for millennia, only comparatively recently did this process initiate the science of biochemistry. The great French microbiologist Louis Pasteur maintained that fermentation could only occur in intact cells. However, in 1899, the brothers Büchner discovered that fermentation could occur in the *absence* of intact cells when they stored a yeast extract in a crock of concentrated sugar solution, added as a preservative. Overnight, the contents of the crock fermented, spilled over the laboratory bench and floor, and dramatically demonstrated that fermentation can proceed in the absence of an intact cell. This discovery unleashed an avalanche of research that initiated the science of biochemistry. Investigations revealed the vital roles of inorganic phosphate, ADP, ATP, and NAD(H), and ultimately identified the phosphorylated sugars and the chemical reactions and enzymes that convert glucose to pyruvate (glycolysis) or to ethanol and CO₂ (fermentation). Research beginning in the 1930s identified the intermediates of the citric acid cycle and of urea

biosynthesis, and revealed the essential roles of certain vitamin-derived cofactors or “coenzymes” such as thiamin pyrophosphate, riboflavin, and ultimately coenzyme A, coenzyme Q, and cobamide coenzyme. The 1950s revealed how complex carbohydrates are synthesized from, and broken down into simple sugars, and the pathways for biosynthesis of pentoses, and the catabolism of amino acids and fatty acids.

Investigators employed animal models, perfused intact organs, tissue slices, cell homogenates and their subfractions, and subsequently purified enzymes. Advances were enhanced by the development of analytical ultracentrifugation, paper and other forms of chromatography, and the post-World War II availability of radioisotopes, principally ^{14}C , ^3H , and ^{32}P , as “tracers” to identify the intermediates in complex pathways such as that of cholesterol biosynthesis. X-ray crystallography was then used to solve the three-dimensional structures of numerous proteins, polynucleotides, enzymes, and viruses. Genetic advances that followed the realization that DNA was a double helix include the polymerase chain reaction, and transgenic animals or those with gene knockouts. The methods used to prepare, analyze, purify, and identify metabolites and the activities of natural and recombinant enzymes and their three-dimensional structures are discussed in the following chapters.

BIOCHEMISTRY & MEDICINE HAVE PROVIDED MUTUAL ADVANCES

The two major concerns for workers in the health sciences—and particularly physicians—are the understanding and maintenance of health and effective treatment of disease. Biochemistry impacts both of these fundamental concerns, and the interrelationship of biochemistry and medicine is a wide, two-way street. Biochemical studies have illuminated many aspects of health and disease, and conversely, the study of various aspects of health and disease has opened up new areas of biochemistry (**Figure 1–1**). An early example of how investigation of protein structure and function revealed the single difference in amino acid sequence between normal hemoglobin and sickle cell hemoglobin. Subsequent analysis of numerous variant sickle cell and other hemoglobins has contributed significantly to our understanding of the structure and function both of hemoglobin and of other proteins. During the early 1900s the English physician Archibald Garrod studied patients with the relatively rare disorders of alkaptonuria, albinism, cystinuria, and pentosuria, and

established that these conditions were genetically determined. Garrod designated these conditions as **inborn errors of metabolism**. His insights provided a foundation for the development of the field of human biochemical genetics. A more recent example was investigation of the genetic and molecular basis of familial hypercholesterolemia, a disease that results in early-onset atherosclerosis. In addition to clarifying different genetic mutations responsible for this disease, this provided a deeper understanding of cell receptors and mechanisms of uptake, not only of cholesterol but also of how other molecules cross cell membranes. Studies of **oncogenes** and **tumor suppressor genes** in cancer cells have directed attention to the molecular mechanisms involved in the control of normal cell growth. These examples illustrate how the study of disease can open up areas of basic biochemical research. Science provides physicians and other workers in health care and biology with a foundation that impacts practice, stimulates curiosity, and promotes the adoption of scientific approaches for continued learning.

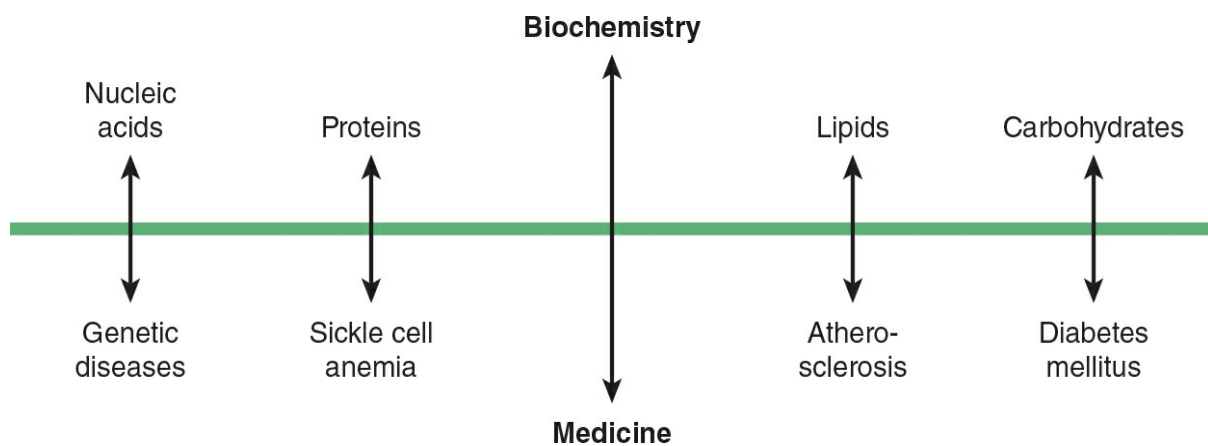

FIGURE 1–1 A two-way street connects biochemistry and medicine. Knowledge of the biochemical topics listed above the green line of the diagram has clarified our understanding of the diseases shown below the green line. Conversely, analyses of the diseases have cast light on many areas of biochemistry. Note that sickle cell anemia is a genetic disease, and that both atherosclerosis and diabetes mellitus have genetic components.

BIOCHEMICAL PROCESSES UNDERLIE HUMAN HEALTH

Biochemical Research Impacts Nutrition & Preventive Medicine

The World Health Organization (WHO) defines health as a state of “complete physical, mental, and social well-being and not merely the absence of disease and infirmity.” From a biochemical viewpoint, health may be considered that situation in which all of the many thousands of intra- and extracellular reactions that occur in the body are proceeding at rates commensurate with the organism’s survival under pressure from both internal and external challenges. The maintenance of health requires optimal dietary intake of **vitamins**, certain **amino acids** and **fatty acids**, various **minerals**, and **water**. Understanding nutrition depends to a great extent on knowledge of biochemistry, and the sciences of biochemistry and nutrition share a focus on these chemicals. Recent increasing emphasis on systematic attempts to maintain health and forestall disease, or **preventive medicine**, includes nutritional approaches to the prevention of diseases such as atherosclerosis and cancer.

Most Diseases Have a Biochemical Basis

Apart from infectious organisms and environmental pollutants, many diseases are manifestations of abnormalities in genes, proteins, chemical reactions, or biochemical processes, each of which can adversely affect one or more critical biochemical functions. Examples of disturbances in human biochemistry responsible for diseases or other debilitating conditions include electrolyte imbalance, defective nutrient ingestion or absorption, hormonal imbalances, toxic chemicals or biologic agents, and DNA-based genetic disorders. To address these challenges, biochemical research continues to be interwoven with studies in disciplines such as genetics, cell biology, immunology, nutrition, pathology, and pharmacology. In addition, many biochemists are vitally interested in contributing to solutions to key issues such as the ultimate survival of mankind, and educating the public to support use of the scientific method in solving environmental and other major problems that confront our civilization.

Impact of the Human Genome Project on Biochemistry, Biology, & Medicine

Initially unanticipated rapid progress in the late 1990s in sequencing the human genome led in the mid-2000s to the announcement that over 90% of the genome had been sequenced. This effort was headed by the International Human Genome Sequencing Consortium and by Celera

Genomics. Except for a few gaps, the sequence of the entire human genome was completed in 2003, just 50 years after the description of the double-helical nature of DNA by Watson and Crick. The implications for biochemistry, medicine, and indeed for all of biology, are virtually unlimited. For example, the ability to isolate and sequence a gene and to investigate its structure and function by sequencing and “gene knockout” experiments have revealed previously unknown genes and their products, and new insights have been gained concerning human evolution and procedures for identifying disease-related genes.

Major advances in biochemistry and understanding human health and disease continue to be made by mutation of the genomes of model organisms such as yeast, the fruit fly *Drosophila melanogaster*, the roundworm *Caenorhabditis elegans*, and the zebra fish, all organisms that can be genetically manipulated to provide insight into the functions of individual genes. These advances can potentially provide clues to curing human diseases such as cancer and Alzheimer disease. **Figure 1–2** highlights areas that have developed or accelerated as a direct result of progress made in the Human Genome Project (HGP). New “-omics” fields focus on comprehensive study of the structures and functions of the molecules with which each is concerned. The products of genes (RNA molecules and proteins) are being studied using the techniques of **transcriptomics** and **proteomics**. A spectacular example of the speed of progress in transcriptomics is the explosion of knowledge about small RNA molecules as regulators of gene activity. Other -omics fields include **glycomics**, **lipidomics**, **metabolomics**, **nutrigenomics**, and **pharmacogenomics**. To keep pace with the information generated, **bioinformatics** has received much attention. Other related fields to which the impetus from the HGP has carried over are **biotechnology**, **bioengineering**, **biophysics**, and **bioethics**. Definitions of these -omics fields and other terms appear in the Glossary of this chapter. **Nanotechnology** is an active area, which, for example, may provide novel methods of diagnosis and treatment for cancer and other disorders. **Stem cell biology** is at the center of much current research. **Gene therapy** has yet to deliver the promise that it appears to offer, but it seems probable that ultimately will occur. Many new **molecular diagnostic tests** have developed in areas such as genetic, microbiologic, and immunologic testing and diagnosis. **Systems biology** is also burgeoning. The outcomes of research in the various areas mentioned above will impact tremendously the future of biology, medicine, and the health sciences. **Synthetic biology** offers the potential for creating living organisms, initially small bacteria,

from genetic material in vitro that might carry out specific tasks such as cleansing petroleum spills. All of the above make the 21st century an exhilarating time to be directly involved in biology and medicine.

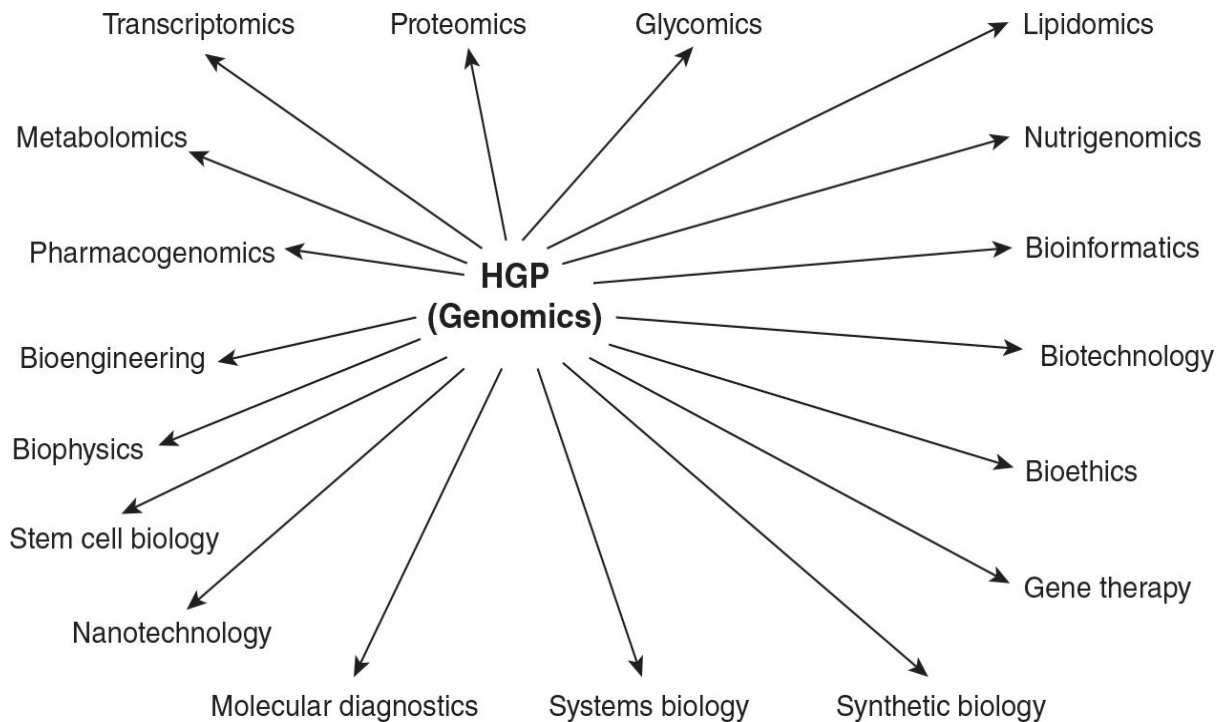

FIGURE 1–2 The Human Genome Project (HGP) has influenced many disciplines and areas of research. Biochemistry is not listed since it predates commencement of the HGP, but disciplines such as bioinformatics, genomics, glycomics, lipidomics, metabolomics, molecular diagnostics, proteomics, and transcriptomics are nevertheless active areas of biochemical research.

SUMMARY

- Biochemistry is the science concerned with the molecules present in living organisms, individual chemical reactions and their enzyme catalysts, and the expression and regulation of each metabolic process. Biochemistry has become the basic language of all biologic sciences.
- Despite the focus on human biochemistry in this text, biochemistry concerns the entire spectrum of life forms, from viruses, bacteria, and plants to complex eukaryotes such as human beings.
- Biochemistry, medicine, and other health care disciplines are intimately related. Health in all species depends on a harmonious balance of the biochemical reactions occurring in the body, while disease reflects abnormalities in biomolecules, biochemical reactions,

or biochemical processes.

- Advances in biochemical knowledge have illuminated many areas of medicine, and the study of diseases has often revealed previously unsuspected aspects of biochemistry.
- Biochemical approaches are often fundamental in illuminating the causes of diseases and in designing appropriate therapy. Biochemical laboratory tests also represent an integral component of diagnosis and monitoring of treatment.
- A sound knowledge of biochemistry and of other related basic disciplines is essential for the rational practice of medicine and related health sciences.
- Results of the HGP and of research in related areas will have a profound influence on the future of biology, medicine, and other health sciences.
- Genomic research on model organisms such as yeast, the fruit fly *D. melanogaster*, the roundworm *C. elegans*, and the zebra fish provides insight into understanding human diseases.

GLOSSARY

Bioengineering: The application of engineering to biology and medicine.

Bioethics: The area of ethics that is concerned with the application of moral and ethical principles to biology and medicine.

Bioinformatics: The discipline concerned with the collection, storage, and analysis of biologic data, for example, DNA, RNA, and protein sequences.

Biophysics: The application of physics and its techniques to biology and medicine.

Biotechnology: The field in which biochemical, engineering, and other approaches are combined to develop biologic products of use in medicine and industry.

Gene Therapy: Applies to the use of genetically engineered genes to treat various diseases.

Genomics: The genome is the complete set of genes of an organism, and genomics is the in-depth study of the structures and functions of genomes.

Glycomics: The glycome is the total complement of simple and complex carbohydrates in an organism. Glycomics is the systematic study of the structures and functions of glycomes such as the human glycome.

Lipidomics: The lipidome is the complete complement of lipids found in an organism. Lipidomics is the in-depth study of the structures and functions of all members of the lipidome and their interactions, in both health and disease.

Metabolomics: The metabolome is the complete complement of metabolites (small molecules involved in metabolism) present in an organism. Metabolomics is the in-depth study of their structures, functions, and changes in various metabolic states.

Molecular Diagnostics: Refers to the use of molecular approaches such as DNA probes to assist in the diagnosis of various biochemical, genetic, immunologic, microbiologic, and other medical conditions.

Nanotechnology: The development and application to medicine and to other areas of devices such as nanoshells, which are only a few nanometers in size (10^{-9} m = 1 nm).

Nutrigenomics: The systematic study of the effects of nutrients on genetic expression and of the effects of genetic variations on the metabolism of nutrients.

Pharmacogenomics: The use of genomic information and technologies to optimize the discovery and development of new drugs and drug targets.

Proteomics: The proteome is the complete complement of proteins of an organism. Proteomics is the systematic study of the structures and functions of proteomes and their variations in health and disease.

Stem Cell Biology: Stem cells are undifferentiated cells that have the potential to self-renew and to differentiate into any of the adult cells of an organism. Stem cell biology concerns the biology of stem cells and their potential for treating various diseases.

Synthetic Biology: The field that combines biomolecular techniques with engineering approaches to build new biologic functions and systems.

Systems Biology: The field concerns complex biologic systems studied as integrated entities.

Transcriptomics: The comprehensive study of the transcriptome, the complete set of RNA transcripts produced by the genome during a fixed period of time.

APPENDIX

Shown are selected examples of databases that assemble, annotate, and analyze data of biomedical importance.

ENCODE: ENCyclopedia Of DNA Elements. A collaborative effort that

combines laboratory and computational approaches to identify every functional element in the human genome.

GenBank: Protein sequence database of the National Institutes of Health (NIH) stores all known biologic nucleotide sequences and their translations in a searchable form.

HapMap: Haplotype Map, an international effort to identify single nucleotide polymorphisms (SNPs) associated with common human diseases and differential responses to pharmaceuticals.

ISDB: International Sequence DataBase that incorporates DNA databases of Japan and of the European Molecular Biology Laboratory (EMBL).

PDB: Protein DataBase. Three-dimensional structures of proteins, polynucleotides, and other macromolecules, including proteins bound to substrates, inhibitors, or other proteins.

Water & pH

Peter J. Kennelly, PhD & Victor W. Rodwell, PhD

OBJECTIVES

After studying this chapter, you should be able to:

- Describe the properties of water that account for its surface tension, viscosity, liquid state at ambient temperature, and solvent power.
- Use structural formulas to represent several organic compounds that can serve as hydrogen bond donors or acceptors.
- Explain the role played by entropy in the orientation, in an aqueous environment, of the polar and nonpolar regions of macromolecules.
- Indicate the quantitative contributions of salt bridges, hydrophobic interactions, and van der Waals forces to the stability of macromolecules.
- Explain the relationship of pH to acidity, alkalinity, and the quantitative determinants that characterize weak and strong acids.
- Calculate the shift in pH that accompanies the addition of a given quantity of acid or base to the pH of a buffered solution.
- Describe what buffers do, how they do it, and the conditions under which a buffer is most effective under physiologic or other

conditions.

- Illustrate how the Henderson-Hasselbalch equation can be used to calculate the net charge on a polyelectrolyte at a given pH.

BIOMEDICAL IMPORTANCE

Water is the predominant chemical component of living organisms. Its unique physical properties, which include the ability to solvate a wide range of organic and inorganic molecules, derive from water's dipolar structure and exceptional capacity for forming hydrogen bonds. The manner in which water interacts with a solvated biomolecule influences the structure both of the biomolecule and of water itself. An excellent nucleophile, water is a reactant or product in many metabolic reactions. Regulation of water balance depends upon hypothalamic mechanisms that control thirst, on antidiuretic hormone (ADH), on retention or excretion of water by the kidneys, and on evaporative loss. Nephrogenic diabetes insipidus, which involves the inability to concentrate urine or adjust to subtle changes in extracellular fluid osmolarity, results from the unresponsiveness of renal tubular osmoreceptors to ADH.

Water has a slight propensity to dissociate into hydroxide ions and protons. The concentration of protons, or **acidity**, of aqueous solutions is generally reported using the logarithmic pH scale. Bicarbonate and other buffers normally maintain the pH of extracellular fluid between 7.35 and 7.45. Suspected disturbances of acid-base balance are verified by measuring the pH of arterial blood and the CO₂ content of venous blood. Causes of acidosis (blood pH <7.35) include diabetic ketosis and lactic acidosis. Alkalosis (pH >7.45) may follow vomiting of acidic gastric contents.

WATER IS AN IDEAL BIOLOGIC SOLVENT

Water Molecules Form Dipoles

A water molecule is an irregular, slightly skewed tetrahedron with oxygen at its center (**Figure 2–1**). The two hydrogens and the unshared electrons of the remaining two sp^3 -hybridized orbitals occupy the corners of the tetrahedron. The 105° angle between the two hydrogen atoms differs slightly from the ideal tetrahedral angle, 109.5°. Ammonia is also tetrahedral, with a 107° angle between its three hydrogens. The strongly

electronegative oxygen atom in a water molecule attracts electrons away from the hydrogen nuclei, leaving them with a partial positive charge, while its two unshared electron pairs constitute a region of local negative charge.

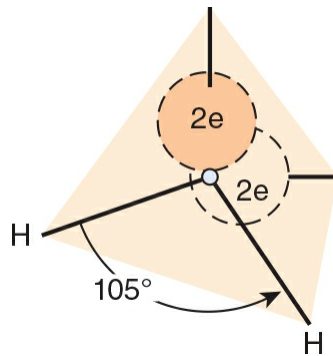

FIGURE 2–1 The water molecule has tetrahedral geometry.

A molecule with electrical charge distributed asymmetrically about its structure is referred to as a **dipole**. Water's strong dipole is responsible for its high **dielectric constant**. As described quantitatively by Coulomb's law, the strength of interaction F between oppositely charged particles is inversely proportionate to the dielectric constant ϵ of the surrounding medium. The dielectric constant for a vacuum is essentially unity; for hexane it is 1.9; for ethanol, 24.3; and for water at 25°C, 78.5. Water therefore greatly decreases the force of attraction between charged and polar species relative to water-free environments with lower dielectric constants. Its strong dipole and high dielectric constant enable water to dissolve large quantities of charged compounds such as salts.

Water Molecules Form Hydrogen Bonds

A partially unshielded hydrogen nucleus covalently bound to an electron-withdrawing oxygen or nitrogen atom can interact with an unshared electron pair on another oxygen or nitrogen atom to form a **hydrogen bond**. Since water molecules contain both of these features, hydrogen bonding favors the self-association of water molecules into ordered arrays (**Figure 2–2**). Hydrogen bonding profoundly influences the physical properties of water and accounts for its relatively high viscosity, surface tension, and boiling point. On average, each molecule in liquid water associates through hydrogen bonds with 3.5 others. These bonds are both relatively weak and transient, with a half-life of a few picoseconds. Rupture of a hydrogen bond in liquid water requires only about 4.5

kcal/mol, less than 5% of the energy required to rupture a covalent O—H bond.

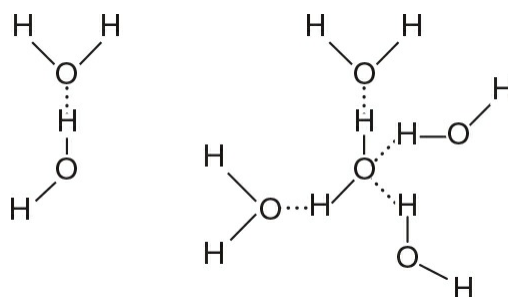

FIGURE 2–2 Water molecules self-associate via hydrogen bonds.

Shown are the association of two water molecules (**left**) and a hydrogen-bonded cluster of four water molecules (**right**). Notice that water can serve simultaneously both as a hydrogen donor and as a hydrogen acceptor.

Hydrogen bonding enables water to dissolve many organic biomolecules that contain functional groups which can participate in hydrogen bonding. The oxygen atoms of aldehydes, ketones, and amides, for example, provide lone pairs of electrons that can serve as hydrogen acceptors. Alcohols, carboxylic acids, and amines can serve both as hydrogen acceptors and as donors of unshielded hydrogen atoms for formation of hydrogen bonds (**Figure 2–3**).

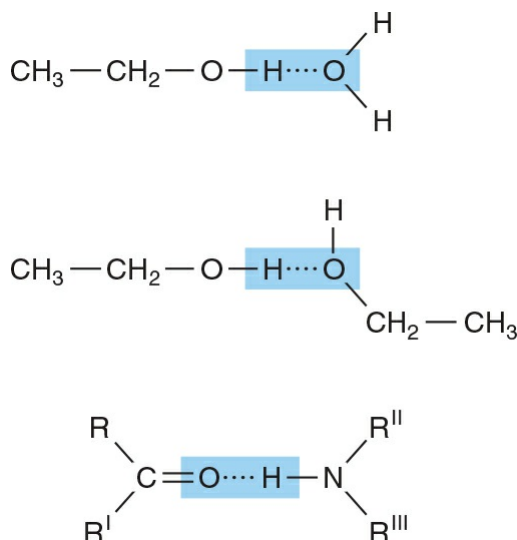

FIGURE 2–3 Additional polar groups participate in hydrogen bonding. Shown are hydrogen bonds formed between alcohol and water, between two molecules of ethanol, and between the peptide carbonyl oxygen and the peptide nitrogen hydrogen of an adjacent amino acid.

INTERACTION WITH WATER INFLUENCES THE STRUCTURE OF BIOMOLECULES

Covalent and Noncovalent Bonds Stabilize Biologic Molecules

The covalent bond is the strongest force that holds molecules together (**Table 2–1**). Noncovalent forces, while of lesser magnitude, make significant contributions to the structure, stability, and functional competence of macromolecules in living cells. These forces, which can be either attractive or repulsive, involve interactions both within the biomolecule and between it and the water that forms the principal component of the surrounding environment.

TABLE 2–1 Bond Energies for Atoms of Biologic Significance

Bond Type	Energy (kcal/mol)	Bond Type	Energy (kcal/mol)
O—O	34	O=O	96
S—S	51	C—H	99
C—N	70	C=S	108
S—H	81	O—H	110
C—C	82	C=C	147
C—O	84	C=N	147
N—H	94	C=O	164

Biomolecules Fold to Position Polar & Charged Groups on Their Surfaces

Most biomolecules are **amphipathic**; that is, they possess regions rich in charged or polar functional groups as well as regions with hydrophobic character. Proteins tend to fold with the R-groups of amino acids with hydrophobic side chains in the interior. Amino acids with charged or polar amino acid side chains (eg, arginine, glutamate, serine, see **Table 3–1**) generally are present on the surface in contact with water. A similar pattern prevails in a phospholipid bilayer where the charged “head groups” of phosphatidylserine or phosphatidylethanolamine contact water while

their hydrophobic fatty acyl side chains cluster together, excluding water (see [Figure 40–5](#)). This pattern maximizes the opportunities for the formation of energetically favorable charge-dipole, dipole-dipole, and hydrogen bonding interactions between polar groups on the biomolecule and water. It also minimizes energetically unfavorable contacts between water and hydrophobic groups.

Hydrophobic Interactions

Hydrophobic interaction refers to the tendency of nonpolar compounds to self-associate in an aqueous environment. This self-association is driven neither by mutual attraction nor by what are sometimes incorrectly referred to as “hydrophobic bonds.” Self-association minimizes the disruption of energetically favorable interactions between the surrounding water molecules.

While the hydrogens of nonpolar groups such as the methylene groups of hydrocarbons do not form hydrogen bonds, they do affect the structure of the water that surrounds them. Water molecules adjacent to a hydrophobic group are restricted in the number of orientations (degrees of freedom) that permit them to participate in the maximum number of energetically favorable hydrogen bonds. Maximal formation of multiple hydrogen bonds, which maximizes enthalpy, can be maintained only by increasing the order of the adjacent water molecules, with an accompanying decrease in entropy.

It follows from the second law of thermodynamics that the optimal free energy of a hydrocarbon-water mixture is a function of both maximal enthalpy (from hydrogen bonding) and highest entropy (maximum degrees of freedom). Thus, nonpolar molecules tend to form droplets that minimize exposed surface area and reduce the number of water molecules whose motional freedom becomes restricted. Similarly, in the aqueous environment of the living cell the hydrophobic portions of biopolymers tend to be buried inside the structure of the molecule, or within a lipid bilayer, minimizing contact with water.

Electrostatic Interactions

Interactions between charged groups help shape biomolecular structure. Electrostatic interactions between oppositely charged groups within or between biomolecules are termed **salt bridges**. Salt bridges are comparable in strength to hydrogen bonds but act over larger distances.

They therefore often facilitate the binding of charged molecules and ions to proteins and nucleic acids.

van der Waals Forces

van der Waals forces arise from attractions between transient dipoles generated by the rapid movement of electrons of all neutral atoms. Significantly weaker than hydrogen bonds but potentially extremely numerous, van der Waals forces decrease as the sixth power of the distance separating atoms (Figure 2–4). Thus, they act over very short distances, typically 2 to 4 Å.

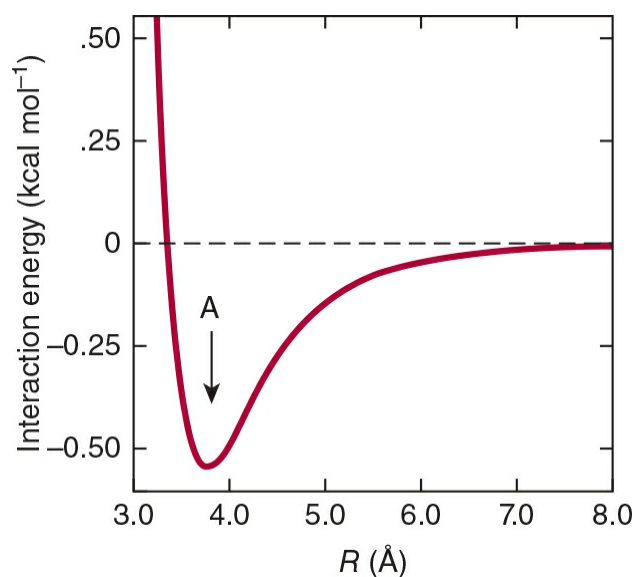

FIGURE 2–4 The strength of van der Waals interactions varies with the distance, R , between interacting species. The force of interaction between interacting species increases with decreasing distance between them until they are separated by the van der Waals contact distance (see arrow marked A). Repulsion due to interaction between the electron clouds of each atom or molecule then supervenes. While individual van der Waals interactions are extremely weak, their cumulative effect is nevertheless substantial for macromolecules such as DNA and proteins which have many atoms in close contact.

Multiple Forces Stabilize Biomolecules

The DNA double helix illustrates the contribution of multiple forces to the structure of biomolecules. While each individual DNA strand is held together by covalent bonds, the two strands of the helix are held together exclusively by noncovalent interactions such as hydrogen bonds between

nucleotide bases (Watson-Crick base pairing) and van der Waals interactions between the stacked purine and pyrimidine bases. The double helix presents the charged phosphate groups and polar hydroxyl groups from the ribose sugars of the DNA backbone to water while burying the relatively hydrophobic nucleotide bases inside. The extended backbone maximizes the distance between negatively charged phosphates, minimizing unfavorable electrostatic interactions (see [Figure 34–2](#)).

WATER IS AN EXCELLENT NUCLEOPHILE

Metabolic reactions often involve the attack by lone pairs of electrons residing on electron-rich molecules termed **nucleophiles** upon electron-poor atoms called **electrophiles**. Nucleophiles and electrophiles do not necessarily possess a formal negative or positive charge. Water, whose two lone pairs of sp^3 electrons bear a partial negative charge (see [Figure 2–1](#)), is an excellent nucleophile. Other nucleophiles of biologic importance include the oxygen atoms of phosphates, alcohols, and carboxylic acids; the sulfur of thiols; and the nitrogen atom of amines and of the imidazole ring of histidine. Common electrophiles include the carbonyl carbons in amides, esters, aldehydes, and ketones and the phosphorus atoms of phosphoesters.

Nucleophilic attack by water typically results in the cleavage of the amide, glycoside, or ester bonds that hold biopolymers together. This process is termed **hydrolysis**. Conversely, when monomer units are joined together to form biopolymers, such as proteins or glycogen, water is a product, for example, during the formation of a peptide bond between two amino acids.

While hydrolysis is a thermodynamically favored reaction, the amide and phosphoester bonds of polypeptides and oligonucleotides are stable in the aqueous environment of the cell. This seemingly paradoxical behavior reflects the fact that the thermodynamics that govern the equilibrium point of a reaction do not determine the *rate* at which it will proceed toward its equilibrium point. In the cell, protein catalysts called **enzymes** accelerate the rate of hydrolytic reactions when needed. **Proteases** catalyze the hydrolysis of proteins into their component amino acids, while **nucleases** catalyze the hydrolysis of the phosphoester bonds in DNA and RNA. Careful control of the activities of these enzymes is required to ensure that they act only at appropriate times.

Many Metabolic Reactions Involve Group Transfer

Many of the enzymic reactions responsible for synthesis and breakdown of biomolecules involve the transfer of a chemical group G from a donor D to an acceptor A to form an acceptor group complex, A—G:

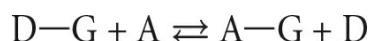

The hydrolysis and phosphorolysis of glycogen, for example, involve the transfer of glucosyl groups to water or to orthophosphate. The equilibrium constant for the hydrolysis of covalent bonds strongly favors the formation of split products. Conversely, many group transfer reactions responsible for the biosynthesis of macromolecules involve the thermodynamically unfavored formation of covalent bonds. Enzyme catalysts play a critical role in surmounting these barriers by virtue of their capacity to directly link two normally separate reactions together. By linking an energetically unfavorable group transfer reaction with a thermodynamically favorable reaction, such as the hydrolysis of ATP, a new coupled reaction can be generated whose net *overall* change in free energy favors biopolymer synthesis.

Given the nucleophilic character of water and its high concentration in cells, why are biopolymers such as proteins and DNA relatively stable? And how can synthesis of biopolymers occur in an aqueous environment that favors hydrolysis? Central to both questions are the properties of enzymes. In the absence of enzymic catalysis, even reactions that are highly favored thermodynamically do not necessarily take place rapidly. Precise and differential control of enzyme activity and the sequestration of enzymes in specific organelles determine the physiologic circumstances under which a given biopolymer will be synthesized or degraded. The ability of enzyme active sites to sequester substrates in an environment from which water can be excluded facilitates biopolymer synthesis.

Water Molecules Exhibit a Slight but Important Tendency to Dissociate

The ability of water to ionize, while slight, is of central importance for life. Since water can act both as an acid and as a base, its ionization may be represented as an intermolecular proton transfer that forms a hydronium ion (H_3O^+) and a hydroxide ion (OH^-):



The transferred proton is actually associated with a cluster of water molecules. Protons exist in solution not only as H_3O^+ , but also as multimers such as H_5O_2^+ and H_7O_3^+ . The proton is nevertheless routinely represented as H^+ , even though it is in fact highly hydrated.

Since hydronium and hydroxide ions continuously recombine to form water molecules, an *individual* hydrogen or oxygen cannot be stated to be present as an ion or as part of a water molecule. At one instant it is an ion; an instant later it is part of a water molecule. Individual ions or molecules are therefore not considered. We refer instead to the *probability* that at any instant in time a given hydrogen will be present as an ion or as part of a water molecule. Since 1 g of water contains 3.46×10^{22} molecules, the ionization of water can be described statistically. To state that the probability that a hydrogen exists as an ion is 0.01 means that at any given moment in time, a hydrogen atom has 1 chance in 100 of being an ion and 99 chances out of 100 of being part of a water molecule. The actual probability of a hydrogen atom in pure water existing as a hydrogen ion is approximately 1.8×10^{-9} . The probability of its being part of a water molecule thus is almost unity. Stated another way, for every hydrogen ion or hydroxide ion in pure water, there are 0.56 billion or 0.56×10^9 water molecules. Hydrogen ions and hydroxide ions nevertheless contribute significantly to the properties of water.

For dissociation of water,

$$K = \frac{[\text{H}^+][\text{OH}^-]}{[\text{H}_2\text{O}]}$$

where the brackets represent molar concentrations (strictly speaking, molar activities) and K is the **dissociation constant**. Since 1 mole (mol) of water weighs 18 g, 1 liter (L) (1000 g) of water contains $1000 \div 18 = 55.56$ mol. Pure water thus is 55.56 molar. Since the probability that a hydrogen in pure water will exist as a hydrogen ion is 1.8×10^{-9} , the molar concentration of H^+ ions (or of OH^- ions) in pure water is the product of the probability, 1.8×10^{-9} , times the molar concentration of water, 55.56 mol/L. The result is 1.0×10^{-7} mol/L.

We can now calculate the dissociation constant K for pure water:

$$K = \frac{[\text{H}^+][\text{OH}^-]}{[\text{H}_2\text{O}]} = \frac{[10^{-7}][10^{-7}]}{[55.56]}$$

$$= 0.018 \times 10^{-14} = 1.8 \times 10^{-16} \text{ mol/L}$$

The molar concentration of water, 55.56 mol/L, is too great to be significantly affected by dissociation. It is therefore considered to be essentially constant. This constant may therefore be incorporated into the dissociation constant K to provide a useful new constant K_w termed the **ion product** for water. The relationship between K_w and K is shown below:

$$K = \frac{[\text{H}^+][\text{OH}^-]}{[\text{H}_2\text{O}]} = 1.8 \times 10^{-16} \text{ mol/L}$$

$$K_w = (K)[\text{H}_2\text{O}] = [\text{H}^+][\text{OH}^-]$$

$$= (1.8 \times 10^{-16} \text{ mol/L})(55.56 \text{ mol/L})$$

$$= 1.00 \times 10^{-14} (\text{mol/L})^2$$

Note that the dimensions of K are moles per liter and those of K_w are moles² per liter². As its name suggests, the ion product K_w is numerically equal to the product of the molar concentrations of H^+ and OH^- :

$$K_w = [\text{H}^+][\text{OH}^-]$$

At 25°C, $K_w = (10^{-7})^2$, or $10^{-14} (\text{mol/L})^2$. At temperatures below 25°C, K_w is somewhat less than 10^{-14} , and at temperatures above 25°C it is somewhat greater than 10^{-14} . Within the stated limitations of temperature, K_w equals $10^{-14} (\text{mol/L})^2$ for all aqueous solutions, even solutions of acids or bases. We use K_w to calculate the pH of acidic and basic solutions.

pH IS THE NEGATIVE LOG OF THE HYDROGEN ION CONCENTRATION

The term **pH** was introduced in 1909 by Sørensen, who defined it as the negative log of the hydrogen ion concentration:

$$\text{pH} = -\log[\text{H}^+]$$

This definition, while not rigorous, suffices for many biochemical purposes. To calculate the pH of a solution:

1. Calculate the hydrogen ion concentration $[H^+]$.
2. Calculate the base 10 logarithm of $[H^+]$.
3. pH is the negative of the value found in step 2.

For example, for pure water at 25°C,

$$\text{pH} = -\log[H^+] = -\log 10^{-7} = -(-7) = 7.0$$

This value is also known as the *power* (English), *puissant* (French), or *potenz* (German) of the exponent, hence the use of the term “p.”

Low pH values correspond to high concentrations of H^+ and high pH values correspond to low concentrations of H^+ .

Acids are **proton donors** and bases are **proton acceptors**. **Strong acids** (eg, HCl, H_2SO_4) completely dissociate into anions and protons even in strongly acidic solutions (low pH). **Weak acids** dissociate only partially in acidic solutions. Similarly, **strong bases** (eg, KOH, NaOH), but not **weak bases** like $Ca(OH)_2$, are completely dissociated even at high pH. Many biochemicals are weak acids. Exceptions include phosphorylated intermediates, whose phosphoryl group contains two dissociable protons, the first of which is strongly acidic.

The following examples illustrate how to calculate the pH of acidic and basic solutions.

Example 1: What is the pH of a solution whose hydrogen ion concentration is 3.2×10^{-4} mol/L?

$$\begin{aligned}\text{pH} &= -\log[H^+] \\ &= -\log(3.2 \times 10^{-4}) \\ &= -\log(3.2) - \log(10^{-4}) \\ &= -0.5 + 4.0 \\ &= 3.5\end{aligned}$$

Example 2: What is the pH of a solution whose hydroxide ion concentration is 4.0×10^{-4} mol/L? We first define a quantity **pOH** that is equal to $-\log[OH^-]$ and that may be derived from the definition of K_w :

$$K_w = [\text{H}^+][\text{OH}^-] = 10^{-14}$$

Therefore,

$$\log[\text{H}^+] + \log[\text{OH}^-] = \log 10^{-14}$$

or

$$\text{pH} + \text{pOH} = 14$$

To solve the problem by this approach:

$$[\text{OH}^-] = 4.0 \times 10^{-4}$$

$$\begin{aligned} \text{pOH} &= -\log[\text{OH}^-] \\ &= -\log(4.0 \times 10^{-4}) \\ &= -\log(4.0) - \log(10^{-4}) \\ &= -0.60 + 4.0 \\ &= 3.4 \end{aligned}$$

Now

$$\begin{aligned} \text{pH} &= 14 - \text{pOH} = 14 - 3.4 \\ &= 10.6 \end{aligned}$$

The examples above illustrate how the logarithmic pH scale facilitates recording and comparing hydrogen ion concentrations that differ by orders of magnitude from one another, 0.00032 M (pH 3.5) and 0.000000000025 M (pH 10.6).

Example 3: What are the pH values of (a) 2.0×10^{-2} mol/L KOH and of (b) 2.0×10^{-6} mol/L KOH? The OH^- arises from two sources, KOH and water. Since pH is determined by the total $[\text{H}^+]$ (and pOH by the total $[\text{OH}^-]$), both sources must be considered. In the first case (a), the contribution of water to the total $[\text{OH}^-]$ is negligible. The same cannot be said for the second case (b):

	Concentration (mol/L)	
	(a)	(b)
Molarity of KOH	2.0×10^{-2}	2.0×10^{-6}
[OH ⁻] from KOH	2.0×10^{-2}	2.0×10^{-6}
[OH ⁻] from water	1.0×10^{-7}	1.0×10^{-7}
Total [OH ⁻]	2.00001×10^{-2}	2.1×10^{-6}

Once a decision has been reached about the significance of the contribution of water, pH may be calculated as above.

The above examples assume that the strong base KOH is completely dissociated in solution and that the concentration of OH⁻ ions was thus equal to that due to the KOH plus that present initially in the water. This assumption is valid for dilute solutions of strong bases or acids, but not for weak bases or acids. Since weak electrolytes dissociate only slightly in solution, we must use the **dissociation constant** to calculate the concentration of [H⁺] (or [OH⁻]) produced by a given molarity of a weak acid (or base) before calculating total [H⁺] (or total [OH⁻]) and subsequently pH.

Functional Groups That Are Weak Acids Have Great Physiologic Significance

Many biochemicals possess functional groups that are weak acids or bases. Carboxyl groups, amino groups, and phosphate esters, whose second dissociation falls within the physiologic range, are present in proteins and nucleic acids, most coenzymes, and most intermediary metabolites. Knowledge of the dissociation of weak acids and bases thus is basic to understanding the influence of intracellular pH on structure and biologic activity. Charge-based separations such as electrophoresis and ion exchange chromatography are also best understood in terms of the dissociation behavior of functional groups.

We term the protonated species (HA or R—NH₃⁺) the **acid** and the unprotonated species (A⁻ or R—NH₂) its **conjugate base**. Similarly, we may refer to a **base** (A⁻ or R—NH₂) and its **conjugate acid** (HA or R—

NH₃⁺).

We express the relative strengths of weak acids and bases in terms of their dissociation constants. Shown below are the expressions for the dissociation constant (K_a) for two representative weak acids, R—COOH and R—NH₃⁺.

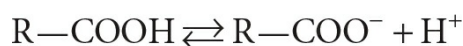

$$K_a = \frac{[\text{R—COO}^-][\text{H}^+]}{[\text{R—COOH}]}$$

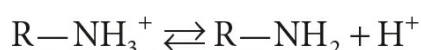

$$K_a = \frac{[\text{R—NH}_2][\text{H}^+]}{[\text{R—NH}_3^+]}$$

Since the numeric values of K_a for weak acids are negative exponential numbers, we express K_a as $\text{p}K_a$, where

$$\text{p}K_a = -\log K_a$$

Note that $\text{p}K_a$ is related to K_a as pH is to $[\text{H}^+]$. The stronger the acid, the lower is its $\text{p}K_a$ value.

Representative weak acids (left), their conjugate bases (center), and $\text{p}K_a$ values (right) include the following:

R—CH ₂ —COOH	R—CH ₂ COO ⁻	$\text{p}K_a = 4-5$
R—CH ₂ —NH ₃ ⁺	R—CH ₂ —NH ₂	$\text{p}K_a = 9-10$
H ₂ CO ₃	HCO ₃ ⁻	$\text{p}K_a = 6.4$
H ₂ PO ₄ ⁻	HPO ₄ ⁻²	$\text{p}K_a = 7.2$

$\text{p}K_a$ is used to express the relative strengths of both acids and bases. For any weak acid, its conjugate is a strong base. Similarly, the conjugate of a strong base is a weak acid. **The relative strengths of bases are expressed in terms of the $\text{p}K_a$ of their conjugate acids.** For polyprotic compounds containing more than one dissociable proton, a numerical subscript is assigned to each dissociation, numbered starting from unity in decreasing order of relative acidity. For a dissociation of the type



the pK_a is the pH at which the concentration of the acid $R-NH_3^+$ equals that of the base $R-NH_2$.

From the above equations that relate K_a to $[H^+]$ and to the concentrations of undissociated acid and its conjugate base, when

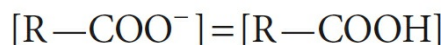

or when

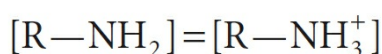

then

$$K_a = [H^+]$$

Thus, when the associated (protonated) and dissociated (conjugate base) species are present at equal concentrations, the prevailing hydrogen ion concentration $[H^+]$ is numerically equal to the dissociation constant, K_a . If the logarithms of both sides of the above equation are taken and both sides are multiplied by -1 , the expressions would be as follows:

$$\begin{aligned} K_a &= [H^+] \\ -\log K_a &= -\log [H^+] \end{aligned}$$

Since $-\log K_a$ is defined as pK_a , and $-\log [H^+]$ defines pH, the equation may be rewritten as

$$pK_a = \text{pH}$$

that is, **the pK_a of an acid group is the pH at which the protonated and unprotonated species are present at equal concentrations.** The pK_a for an acid may be determined by adding 0.5 equivalent of alkali per equivalent of acid. The resulting pH will equal the pK_a of the acid.

The Henderson-Hasselbalch Equation Describes the Behavior of Weak Acids & Buffers

The Henderson-Hasselbalch equation is derived below.

A weak acid, HA, ionizes as follows:

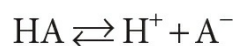

The equilibrium constant for this dissociation is

$$K_a = \frac{[\text{H}^+][\text{A}^-]}{[\text{HA}]}$$

Cross-multiplication gives

$$[\text{H}^+][\text{A}^-] = K_a[\text{HA}]$$

Divide both sides by $[\text{A}^-]$:

$$[\text{H}^+] = K_a \frac{[\text{HA}]}{[\text{A}^-]}$$

Take the log of both sides:

$$\begin{aligned} \log[\text{H}^+] &= \log\left(K_a \frac{[\text{HA}]}{[\text{A}^-]}\right) \\ &= \log K_a + \log \frac{[\text{HA}]}{[\text{A}^-]} \end{aligned}$$

Multiply through by -1 :

$$-\log[\text{H}^+] = -\log K_a - \log \frac{[\text{HA}]}{[\text{A}^-]}$$

Substitute pH and $\text{p}K_a$ for $-\log [\text{H}^+]$ and $-\log K_a$, respectively; then

$$\text{pH} = \text{p}K_a - \log \frac{[\text{HA}]}{[\text{A}^-]}$$

Inversion of the last term removes the minus sign and gives the **Henderson-Hasselbalch equation**

$$\text{pH} = \text{p}K_a + \log \frac{[\text{A}^-]}{[\text{HA}]}$$

The Henderson-Hasselbalch equation has great predictive value in protonic

equilibria. For example,

1. When an acid is exactly half-neutralized, $[A^-] = [HA]$. Under these conditions,

$$\text{pH} = \text{p}K_a + \log \frac{[A^-]}{[HA]} = \text{p}K_a + \log \left(\frac{1}{1} \right) = \text{p}K_a + 0$$

Therefore, at half-neutralization, $\text{pH} = \text{p}K_a$.

2. When the ratio $[A^-]/[HA] = 100:1$,

$$\text{pH} = \text{p}K_a + \log \frac{[A^-]}{[HA]}$$

$$\text{pH} = \text{p}K_a + \log(100/1) = \text{p}K_a + 2$$

3. When the ratio $[A^-]/[HA] = 1:10$,

$$\text{pH} = \text{p}K_a + \log(1/10) = \text{p}K_a + (-1)$$

If the equation is evaluated at ratios of $[A^-]/[HA]$ ranging from 10^3 to 10^{-3} and the calculated pH values are plotted, the resulting graph describes the titration curve for a weak acid (**Figure 2-5**).

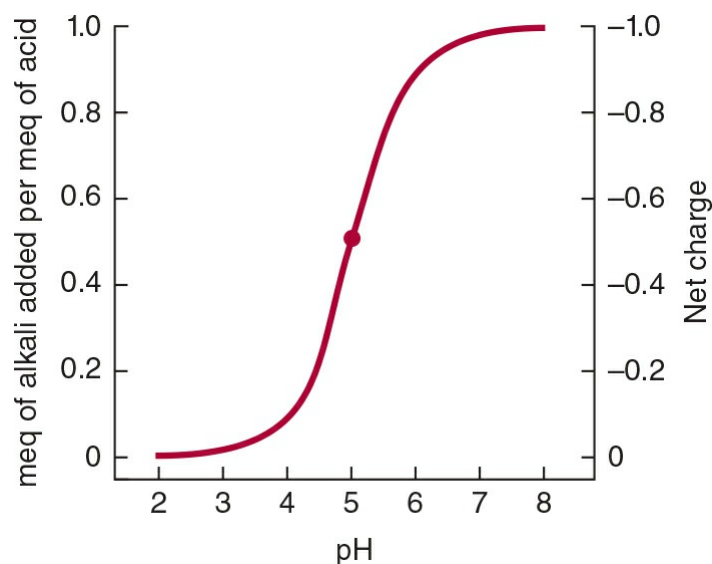

FIGURE 2-5 Titration curve for an acid of the type HA. The heavy dot in the center of the curve indicates the $\text{p}K_a$, 5.0.

Solutions of Weak Acids & Their Salts Buffer

Changes in pH

Solutions of weak acids or bases and their conjugates exhibit **buffering**, the ability to resist a change in pH following addition of strong acid or base. Many metabolic reactions are accompanied by the release or uptake of protons. Oxidative metabolism produces CO_2 , the anhydride of carbonic acid, which if not buffered would produce severe acidosis. Biologic maintenance of a constant pH involves buffering by phosphate, bicarbonate, and proteins, which accept or release protons to resist a change in pH. For laboratory experiments using tissue extracts or enzymes, constant pH is maintained by the addition of buffers such as MES ([2-*N*-morpholino]-ethanesulfonic acid, $\text{p}K_a$ 6.1), inorganic orthophosphate ($\text{p}K_{a2}$ 7.2), HEPES (*N*-hydroxyethylpiperazine-*N'*-2-ethanesulfonic acid, $\text{p}K_a$ 6.8), or Tris (tris[hydroxymethyl]aminomethane, $\text{p}K_a$ 8.3). The value of $\text{p}K_a$ relative to the desired pH is the major determinant of which buffer is selected.

Buffering can be observed by using a pH meter while titrating a weak acid or base (Figure 2–5). We can also calculate the pH shift that accompanies addition of acid or base to a buffered solution. In the example below, the buffered solution (a weak acid, $\text{p}K_a = 5.0$, and its conjugate base) is initially at one of four pH values. We will calculate the pH shift that results when 0.1 meq of KOH is added to 1 meq of each solution:

Initial pH	5.00	5.37	5.60	5.86
$[\text{A}^-]_{\text{initial}}$	0.50	0.70	0.80	0.88
$[\text{HA}]_{\text{initial}}$	0.50	0.30	0.20	0.12
$([\text{A}^-]/[\text{HA}])_{\text{initial}}$	1.00	2.33	4.00	7.33
Addition of 0.1 meq of KOH Produces				
$[\text{A}^-]_{\text{final}}$	0.60	0.80	0.90	0.98
$[\text{HA}]_{\text{final}}$	0.40	0.20	0.10	0.02
$([\text{A}^-]/[\text{HA}])_{\text{final}}$	1.50	4.00	9.00	49.0
$\log([\text{A}^-]/[\text{HA}])_{\text{final}}$	0.18	0.60	0.95	1.69
Final pH	5.18	5.60	5.95	6.69
ΔpH	0.18	0.60	0.95	1.69

Notice that ΔpH , the change in pH per milliequivalent of OH^- added, depends on the initial pH. The solution resists changes in pH most effectively at pH values close to the pK_a . **A solution of a weak acid and its conjugate base buffers most effectively in the pH range $\text{pK}_a \pm 1.0$ pH unit.**

Figure 2–5 also illustrates how the net charge on one molecule of the acid varies with pH. A fractional charge of -0.5 does not mean that an individual molecule bears a fractional charge but that the *probability* is 0.5 that a given molecule has a unit negative charge at any given moment in time. Consideration of the net charge on macromolecules as a function of pH provides the basis for separatory techniques such as ion exchange chromatography and electrophoresis (see Chapter 4).

Acid Strength Depends on Molecular Structure

Many acids of biologic interest possess more than one dissociating group. The presence of local negative charge hinders proton release from nearby acidic groups, raising their pK_a . This is illustrated by the pK_a values of the three dissociating groups of phosphoric acid and citric acid (Table 2–2). The effect of adjacent charge decreases with distance. The second pK_a for succinic acid, which has two methylene groups between its carboxyl groups, is 5.6, whereas the second pK_a for glutaric acid, which has one additional methylene group, is 5.4.

TABLE 2–2 Relative Strengths of Monoprotic, Diprotic, and Triprotic Acids

Lactic acid	$\text{pK} = 3.86$
Acetic acid	$\text{pK} = 4.76$
Ammonium ion	$\text{pK} = 9.25$
Carbonic acid	$\text{pK}_1 = 6.37; \quad \text{pK}_2 = 10.25$
Succinic acid	$\text{pK}_1 = 4.21; \quad \text{pK}_2 = 5.64$
Glutaric acid	$\text{pK}_1 = 4.34; \quad \text{pK}_2 = 5.41$
Phosphoric acid	$\text{pK}_1 = 2.15; \quad \text{pK}_2 = 6.82; \quad \text{pK}_3 = 12.38$
Citric acid	$\text{pK}_1 = 3.08; \quad \text{pK}_2 = 4.74; \quad \text{pK}_3 = 5.40$

Note: Tabulated values are the pK_a values ($-\log$ of the dissociation constant).

pK_a Values Depend on the Properties of the Medium

The pK_a of a functional group is also profoundly influenced by the surrounding medium. The medium may either raise or lower the pK_a relative to its value in water, depending on whether the undissociated acid or its conjugate base is the charged species. The effect of dielectric constant on pK_a may be observed by adding ethanol to water. The pK_a of a carboxylic acid *increases*, whereas that of an amine *decreases* because ethanol decreases the ability of water to solvate a charged species. The pK_a values of dissociating groups in the interiors of proteins thus are profoundly affected by their local environment, including the presence or absence of water.

SUMMARY

- Water forms hydrogen-bonded clusters with itself and with other proton donors or acceptors. Hydrogen bonds account for the surface tension, viscosity, liquid state at room temperature, and solvent power of water.
- Compounds that contain O or N can serve as hydrogen bond donors and/or acceptors.
- Entropic forces dictate that macromolecules expose polar regions to an aqueous interface and bury nonpolar regions.
- Salt bridges, hydrophobic interactions, and van der Waals forces participate in maintaining molecular structure.
- pH is the negative log of [H⁺]. A low pH characterizes an acidic solution, and a high pH denotes a basic solution.
- The strength of weak acids is expressed by pK_a, the negative log of the acid dissociation constant. Strong acids have low pK_a values and weak acids have high pK_a values.
- Buffers resist a change in pH when protons are produced or consumed. Maximum buffering capacity occurs ±1 pH unit on either side of pK_a. Physiologic buffers include bicarbonate, orthophosphate, and proteins.

REFERENCES

Reese KM: Whence came the symbol pH. Chem & Eng News 2004;82:64.

- Segel IM: *Biochemical Calculations*. Wiley, 1968.
- Skinner JL: Following the motions of water molecules in aqueous solutions. *Science* 2010;328:985.
- Stillinger FH: Water revisited. *Science* 1980;209:451.
- Suresh SJ, Naik VM: Hydrogen bond thermodynamic properties of water from dielectric constant data. *J Chem Phys* 2000;113:9727.
- Wiggins PM: Role of water in some biological processes. *Microbiol Rev* 1990;54:432.

Amino Acids & Peptides

Peter J. Kennelly, PhD & Victor W. Rodwell, PhD

OBJECTIVES

After studying this chapter, you should be able to:

- Diagram the structures and write the three- and one-letter designations for each of the amino acids present in proteins.
- Provide examples of how each type of R group of the protein amino acids contributes to their chemical properties.
- List additional important functions of amino acids and explain how certain amino acids in plant seeds can severely impact human health.
- Name the ionizable groups of the protein amino acids and list their approximate pK_a values as free amino acids in aqueous solution.
- Calculate the pH of an unbuffered aqueous solution of a polyfunctional amino acid and the change in pH that occurs following the addition of a given quantity of strong acid or alkali.
- Define pI and explain its relationship to the net charge on a polyfunctional electrolyte.
- Explain how pH, pK_a and pI can be used to predict the mobility of a polyelectrolyte, such as an amino acid, in a direct-current

electrical field.

- Describe the directionality, nomenclature, and primary structure of peptides.
- Describe the conformational consequences of the partial double-bond character of the peptide bond and identify the bonds in the peptide backbone that are free to rotate.

BIOMEDICAL IMPORTANCE

L- α -Amino acids provide the monomer units of the long polypeptide chains of proteins. In addition, these amino acids and their derivatives participate in cellular functions as diverse as nerve transmission, and the biosynthesis of porphyrins, purines, pyrimidines, and urea. The neuroendocrine system employs short polymers of amino acids called *peptides* as hormones, hormone-releasing factors, neuromodulators, and neurotransmitters. Humans and other higher animals cannot synthesize 10 of the L- α -amino acids present in proteins in amounts adequate to support infant growth or to maintain adult health. Consequently, the human diet must contain adequate quantities of these *nutritionally essential* amino acids. Each day the kidneys filter over 50 g of free amino acids from the arterial renal blood. However, only traces of free amino acids normally appear in the urine because amino acids are almost totally reabsorbed in the proximal tubule, conserving them for protein synthesis and other vital functions.

Certain microorganisms secrete free D-amino acids, or peptides that may contain both D- and L- α -amino acids. Several of these bacterial peptides are of therapeutic value, including the antibiotics bacitracin and gramicidin A, and the antitumor agent bleomycin. Certain other microbial peptides are, however, toxic. The cyanobacterial peptides microcystin and nodularin are lethal in large doses, while small quantities promote the formation of hepatic tumors. The ingestion of certain amino acids present in the seeds of legumes of the genus *Lathyrus* can result in lathyrism, a tragic irreversible disease in which individuals lose control of their limbs. Certain other plant seed amino acids have also been implicated in neurodegenerative disease in natives of Guam.

PROPERTIES OF AMINO ACIDS

The Genetic Code Specifies 20 L- α -Amino Acids

Although more than 300 amino acids occur in nature, proteins are synthesized almost exclusively from the set of 20 L- α -amino acids encoded by nucleotide triplets called **codons** (see [Table 37–1](#)). While the three-letter genetic code could potentially accommodate more than 20 amino acids, the genetic code is *redundant* since several amino acids are specified by multiple codons. Scientists frequently represent the sequences of peptides and proteins using one- and three-letter abbreviations for each amino acid ([Table 3–1](#)). The R groups of amino acids can be characterized as being either hydrophilic or hydrophobic ([Table 3–2](#)); properties that affect their location in a protein's mature folded conformation (see [Chapter 5](#)). Some proteins contain additional amino acids that arise by the **posttranslational** modification of an amino acid already present in a peptide. Examples include the conversion of peptidyl proline and peptidyl lysine to 4-hydroxyproline and 5-hydroxylysine; the conversion of peptidyl glutamate to γ -carboxyglutamate; and the methylation, formylation, acetylation, prenylation, and phosphorylation of certain aminoacyl residues. These modifications significantly extend the biologic diversity of proteins by altering their solubility, stability, catalytic activity, and interaction with other proteins.

TABLE 3–1 L- α -Amino Acids Present in Proteins

Name	Symbol	Structural Formula	pK ₁	pK ₂	pK ₃
With Aliphatic Side Chains			α-COOH	α-NH ₂ ⁺	R Group
Glycine	Gly[G]	$\begin{array}{c} \text{H}-\text{CH}-\text{COO}^- \\ \\ \text{NH}_3^+ \end{array}$	2.4	9.8	
Alanine	Ala[A]	$\begin{array}{c} \text{CH}_3-\text{CH}-\text{COO}^- \\ \\ \text{NH}_3^+ \end{array}$	2.4	9.9	
Valine	Val[V]	$\begin{array}{c} \text{H}_3\text{C} \\ \diagdown \\ \text{CH}-\text{CH}-\text{COO}^- \\ / \quad \\ \text{H}_3\text{C} \quad \text{NH}_3^+ \end{array}$	2.2	9.7	
Leucine	Leu[L]	$\begin{array}{c} \text{H}_3\text{C} \\ \diagdown \\ \text{CH}-\text{CH}_2-\text{CH}-\text{COO}^- \\ / \quad \quad \\ \text{H}_3\text{C} \quad \quad \text{NH}_3^+ \end{array}$	2.3	9.7	
Isoleucine	Ile[I]	$\begin{array}{c} \text{CH}_3 \\ \diagdown \\ \text{CH}_2 \\ \diagdown \\ \text{CH}-\text{CH}-\text{COO}^- \\ / \quad \\ \text{CH}_3 \quad \text{NH}_3^+ \end{array}$	2.3	9.8	
With Side Chains Containing Hydroxylic(OH) Groups					
Serine	Ser[S]	$\begin{array}{c} \text{CH}_2-\text{CH}-\text{COO}^- \\ \quad \\ \text{OH} \quad \text{NH}_3^+ \end{array}$	2.2	9.2	about 13
Threonine	Thr[T]	$\begin{array}{c} \text{CH}_3-\text{CH}-\text{CH}-\text{COO}^- \\ \quad \\ \text{OH} \quad \text{NH}_3^+ \end{array}$ <p style="text-align: center;">See below.</p>	2.1	9.1	about 13
Tyrosine	Tyr[Y]	See below.			

With Side Chains Containing Sulfur Atoms					
Cysteine	Cys[C]	$\begin{array}{c} \text{CH}_2 - \text{CH} - \text{COO}^- \\ \quad \\ \text{SH} \quad \text{NH}_3^+ \end{array}$	1.9	10.8	8.3
Methionine	Met[M]	$\begin{array}{c} \text{CH}_2 - \text{CH}_2 - \text{CH} - \text{COO}^- \\ \quad \\ \text{S} - \text{CH}_3 \quad \text{NH}_3^+ \end{array}$	2.1	9.3	
With Side Chains Containing Acidic Groups or Their Amides					
Aspartic Acid	Asp[D]	$\begin{array}{c} -\text{OOC} - \text{CH}_2 - \text{CH} - \text{COO}^- \\ \\ \text{NH}_3^+ \end{array}$	2.1	9.9	3.9
Asparagine	Asn[N]	$\begin{array}{c} \text{H}_2\text{N} - \text{C} - \text{CH}_2 - \text{CH} - \text{COO}^- \\ \quad \\ \text{O} \quad \text{NH}_3^+ \end{array}$	2.1	8.8	
Glutamic Acid	Glu[E]	$\begin{array}{c} -\text{OOC} - \text{CH}_2 - \text{CH}_2 - \text{CH} - \text{COO}^- \\ \\ \text{NH}_3^+ \end{array}$	2.1	9.5	4.1
Glutamine	Gln[Q]	$\begin{array}{c} \text{H}_2\text{N} - \text{C} - \text{CH}_2 - \text{CH}_2 - \text{CH} - \text{COO}^- \\ \quad \\ \text{O} \quad \text{NH}_3^+ \end{array}$	2.2	9.1	
With Side Chains Containing Basic Groups					
Argine	Arg[R]	$\begin{array}{c} \text{H} - \text{N} - \text{CH}_2 - \text{CH}_2 - \text{CH}_2 - \text{CH} - \text{COO}^- \\ \quad \\ \text{C} = \text{NH}_2^+ \quad \text{NH}_3^+ \\ \\ \text{NH}_2 \end{array}$	1.8	9.0	12.5
Lysine	Lys[K]	$\begin{array}{c} \text{CH}_2 - \text{CH}_2 - \text{CH}_2 - \text{CH}_2 - \text{CH} - \text{COO}^- \\ \quad \\ \text{NH}_3^+ \quad \text{NH}_3^+ \end{array}$	2.2	9.2	10.8
Histidine	His[H]		1.8	9.3	6.0
Containing Aromatic Rings					
Histidine	His[H]	See above			
Phenylalanine	Phe[F]	See above. 	2.2	9.2	
Tyrosine	Try[Y]		2.2	9.1	10.1
Tryptophan	Trp[W]		2.4	9.4	
Imino Acid					
Proline	Pro[P]		2.0	10.6	

TABLE 3–2 Hydrophilic & Hydrophobic Amino Acids

Hydrophilic	Hydrophobic
Arginine	Alanine
Asparagine	Isoleucine
Aspartic acid	Leucine
Cysteine	Methionine
Glutamic acid	Phenylalanine
Glutamine	Proline
Glycine	Tryptophan
Histidine	Tyrosine
Lysine	Valine
Serine	
Threonine	

The distinction is based on the tendency to associate with, or to minimize contact with, an aqueous environment.

Selenocysteine, the 21st Protein L- α -Amino Acid

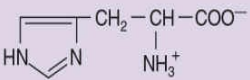
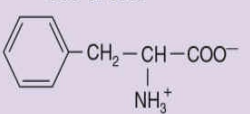
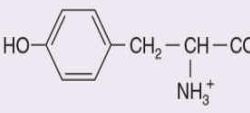
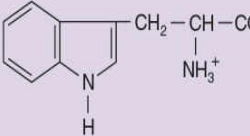
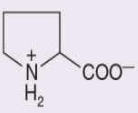
Selenocysteine (**Figure 3–1**) is an L- α -amino acid present in proteins from every domain of life. Humans contain approximately two dozen selenoproteins that include certain peroxidases and reductases, selenoprotein P, which circulates in the plasma, and the iodothyronine deiodinases responsible for converting the prohormone thyroxine (T₄) to the thyroid hormone 3,3',5'-triiodothyronine (T₃) (see **Chapter 41**). Peptidyl selenocysteine is not the product of a posttranslational modification, but is inserted directly into a growing polypeptide during *translation*.

Selenocysteine thus is commonly termed the “21st amino acid.” However, unlike the other 20 protein amino acids, incorporation of selenocysteine is specified by a large and complex genetic element for the unusual tRNA called tRNA^{Sec} which utilizes the UGA anticodon that normally signals STOP. However, the protein synthetic apparatus can identify a selenocysteine-specific UGA codon by the presence of an accompanying stem-loop structure, the selenocysteine insertion element, in the untranslated region of the mRNA (see **Chapter 27**).

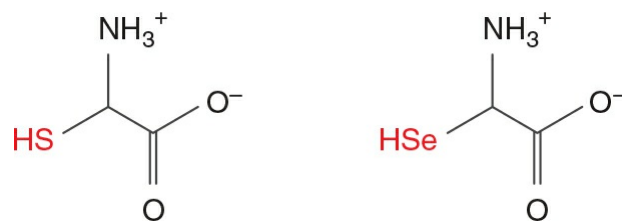

FIGURE 3–1 Cysteine (left) & selenocysteine (right). pK_3 , for the selenyl proton of selenocysteine is 5.2. Since this is 3 pH units lower than that of cysteine, selenocysteine represents a better nucleophile at or below pH 7.4.

Stereochemistry of the Protein Amino Acids

With the sole exception of glycine, the α -carbon of every amino acid is chiral. Although some protein amino acids are dextrorotatory and some levorotatory, all share the absolute configuration of L-glyceraldehyde and thus are defined as L- α -amino acids. Even though almost all protein amino acids are (*R*), the failure to use (*R*) or (*S*) to express *absolute* stereochemistry is no mere historical aberration. L-Cysteine is (*S*) since the atomic mass of the sulfur atom on C3 exceeds that of the amino group on C2. More significantly, in mammals the biochemical reactions of L- α -amino acids, their precursors, and their catabolites are catalyzed by enzymes that act exclusively on L-isomers, irrespective of their absolute configuration.

Posttranslational Modifications Confer Additional Properties

While some prokaryotes incorporate pyrrolysine into proteins, and plants can incorporate azetidine-2-carboxylic acid, an analog of proline, a set of just 21 L- α -amino acids clearly suffices for the formation of most proteins. Posttranslational modifications can, however, generate novel R groups that impart further properties. In collagen, protein-bound proline and lysine residues are converted to 4-hydroxyproline and 5-hydroxylysine (**Figure 3–2**). The carboxylation of glutamyl residues of proteins of the blood coagulation cascade to γ -carboxyglutamyl residues (**Figure 3–3**) forms a chelating group for the calcium ion essential for blood coagulation. The amino acid side chains of histones are subject to numerous modifications, including acetylation and methylation of lysine and methylation and deamination of arginine (see [Chapters 35](#) and [37](#)). It is also now possible in the laboratory to genetically introduce many different unnatural amino

acids into proteins, generating proteins via recombinant gene expression with new or enhanced properties and providing a new way to explore protein structure–function relationships.

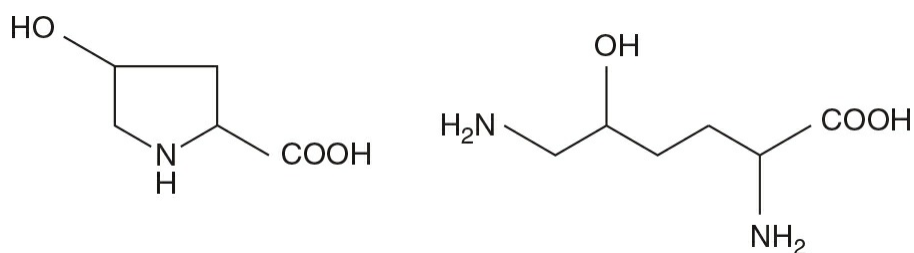

FIGURE 3–2 4-Hydroxyproline & 5-hydroxylysine.

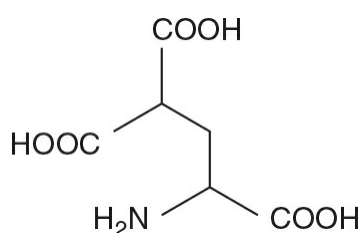

FIGURE 3–3 γ -Carboxyglutamic acid.

Extraterrestrial Amino Acids Have Been Detected in Meteorites

In February 2013, the explosion of an approximately 20,000 metric ton meteor in the skies above Chelyabinsk, Western Siberia, dramatically demonstrated its potential destructive power. However, some meteorites, the remnants of asteroids that have reached earth, contain traces of several α -amino acids. These include the protein amino acids Ala, Asp, Glu, Gly, Ile, Leu, Phe, Ser, Thr, Tyr, and Val, as well as biologically important nonprotein α -amino acids such as *N*-methylglycine (sarcosine) and β -alanine.

Extraterrestrial amino acids were first reported in 1969 following analysis of the famous Murchison meteorite from southeastern Australia. The presence of amino acids in other meteorites, including some pristine examples from Antarctica, has now been amply confirmed. Unlike terrestrial amino acids, these meteorites contain racemic mixtures of D- and L-isomers of 3- to 5-carbon amino acids, as well as many additional amino acids that lack terrestrial counterparts of biotic origin. Nucleobases, activated phosphates, and molecules related to sugars have also been detected in meteorites. These findings offer potential insights into the

prebiotic chemistry of Earth, and impact the search for extraterrestrial life. Some speculate that meteorites may have contributed to the origin of life on our planet, by delivering extraterrestrially generated organic molecules to our earth.

L- α -Amino Acids Serve Additional Metabolic Roles



L- α -Amino acids fulfill vital metabolic roles in addition to serving as the “building blocks” of proteins. For example, tyrosine is a precursor of thyroid hormone, and both tyrosine and phenylalanine are metabolized to epinephrine, norepinephrine, and dihydroxyphenylalanine (DOPA). Glutamate is both a neurotransmitter and the precursor of γ -aminobutyric acid (GABA). Ornithine and citrulline are intermediates in urea biosynthesis, and homocysteine, homoserine, and glutamate- γ -semialdehyde are intermediates in the metabolism of the protein amino acids.

Certain Plant L- α -Amino Acids Can Adversely Impact Human Health

The consumption of plants that contain certain nonprotein amino acids can adversely impact human health. The seeds and seed products of three species of the legume *Lathyrus* have been implicated in the genesis of **neurolathyrism**, a profound neurologic disorder characterized by progressive and irreversible spastic paralysis of the legs. Lathyrism occurs widely during famines, when *Lathyrus* seeds represent a major contribution to the diet. L- α -Amino acids that have been implicated in human neurologic disorders, notably neurolathyrisms, include L-homoarginine and β -N-oxalyl-L- α,β -diaminopropionic acid (β -ODAP **Table 3–3**). The seeds of the “sweet pea,” a *Lathyrus* legume that is widely consumed during famines, contain the osteolathyrigen γ -glutamyl- β -aminopropionitrile (BAPN), a glutamine derivative of β -aminopropionitrile (structure not shown). The seeds of certain *Lathyrus* species also contain α,γ -diaminobutyric acid, which as an analog of ornithine inhibits the hepatic urea cycle enzyme ornithine transcarbamylase, disrupts the urea cycle, and leads to ammonia toxicity. Finally, L- β -methylaminoalanine, a neurotoxic amino acid that is present in *Cycad* seeds, has been implicated as a risk factor for neurodegenerative diseases including amyotrophic lateral sclerosis–Parkinson dementia complex in natives of Guam who consume either fruit bats that feed on

cycad fruit, or flour made from cycad seeds.

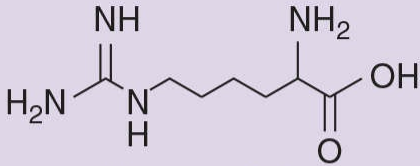
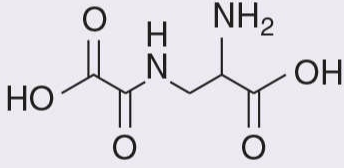
TABLE 3–3 Potentially Toxic L- α -Amino Acids

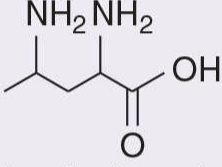
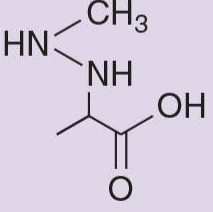
Nonprotein L- α -Amino Acid	Medical Relevance
 <p>Homoarginine</p>	Cleaved by arginase to L-lysine and urea. Implicated in human neurolethyrism.
 <p>β-N-Oxalyl diaminopropionic acid (β-ODAP)</p>	A neurotoxin. Implicated in human neurolethyrism.
 <p>β-N-Glutamylamino-propiononitrile (BAPN)</p>	An osteolethrogen.
 <p>2,4-Diaminobutyric acid</p>	Inhibits ornithine transcarbamylase, resulting in ammonia toxicity.
 <p>β-Methylaminoalanine</p>	Possible risk factor for neurodegenerative diseases.

D-Amino Acids

D-Amino acids that occur naturally include free D-serine and D-aspartate

in human brain tissue, D-alanine and D-glutamate in the cell walls of gram-positive bacteria, and D-amino acids in certain peptides and antibiotics produced by bacteria, fungi, reptiles, and amphibians. *Bacillus subtilis* excretes D-methionine, D-tyrosine, D-leucine, and D-tryptophan to trigger biofilm disassembly, and *Vibrio cholerae* incorporates D-leucine and D-methionine into the peptide component of its peptidoglycan layer.

PROPERTIES OF THE FUNCTIONAL GROUPS OF AMINO ACIDS

Amino Acids May Have Positive, Negative, or Zero Net Charge

In aqueous solution, the charged and uncharged forms of the ionizable weak acid groups —COOH and —NH_3^+ exist in dynamic protonic equilibrium:

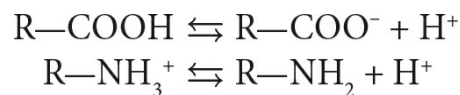

While both R—COOH and R—NH_3^+ are weak acids, R—COOH is a far stronger acid than R—NH_3^+ . Thus, at physiologic pH (pH 7.4), carboxyl groups exist almost entirely as R—COO^- and amino groups predominantly as R—NH_3^+ . The imidazole group of histidine and the guanidino group of arginine exists as resonance hybrids with positive charge distributed between two nitrogens (histidine) or three nitrogens (arginine) (**Figure 3–4**). **Figure 3–5** illustrates the effect that the pH of the aqueous environment has on the charged state of aspartic acid.

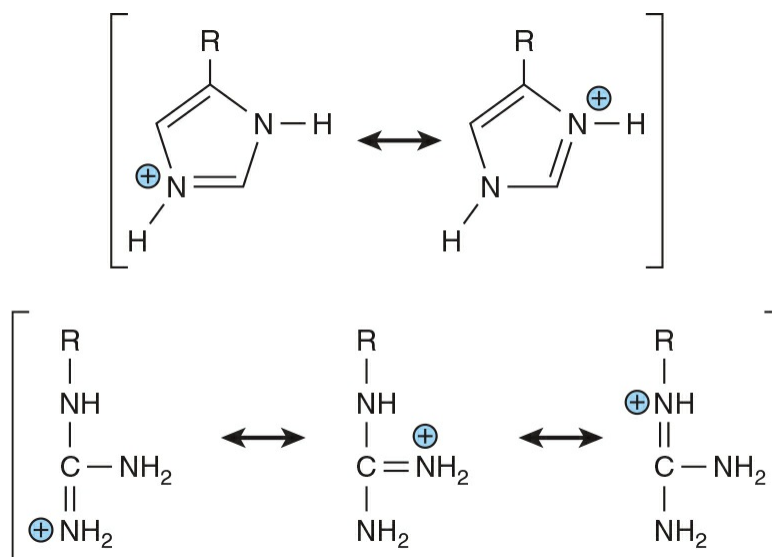

FIGURE 3-4 Resonance hybrids of the protonated R groups of histidine (top) and arginine (bottom).

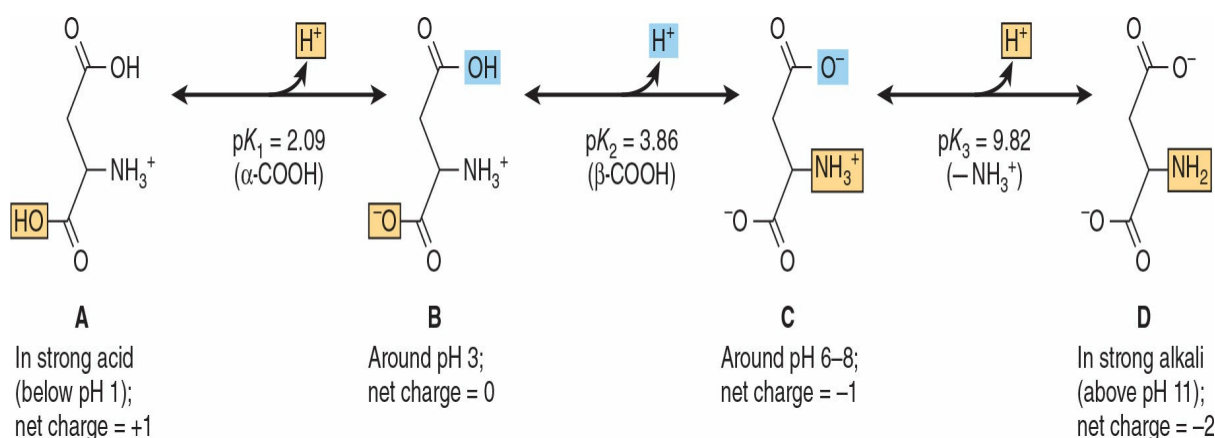
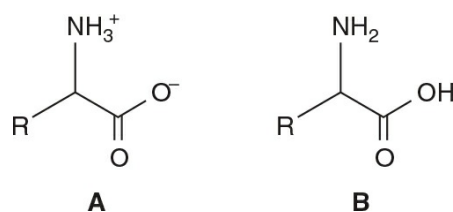

FIGURE 3-5 Protonic equilibria of aspartic acid.

Molecules that contain an equal number of positively and negatively charged groups bear no *net* charge. These ionized neutral species are termed **zwitterions**. Amino acids in blood and most tissues thus should be represented as in **A**, below.



Structure **B** cannot exist in aqueous solution because at any pH low enough to protonate the carboxyl group, the amino group would also be

protonated. Similarly, at any pH sufficiently high for an uncharged amino group to predominate, a carboxyl group will be present as R—COO⁻. The uncharged representation B is, however, often used when diagramming reactions that do not involve protonic equilibria.

pK_a Values Express the Strengths of Weak Acids

The strengths of weak acids are expressed as their **pK_a**. For molecules with multiple dissociable protons, the pK_a for each acidic group is designated by replacing the subscript “a” with a number. The net charge on an amino acid—the algebraic sum of all the positively and negatively charged groups present—depends on the pK_a values of its functional groups and the pH of the surrounding medium. In the laboratory, altering the charge on amino acids and their derivatives by varying the pH facilitates the physical separation of amino acids, peptides, and proteins (see [Chapter 4](#)).

At Its Isoelectric pH (pI), an Amino Acid Bears No Net Charge

Zwitterions are one example of an *isoelectric* species—the form of a molecule that has an equal number of positive and negative charges and thus is electrically neutral. The isoelectric pH, also called the pI, is the pH midway between pK_a values for the ionizations on either side of the isoelectric species. For an amino acid such as alanine that has only two dissociating groups, there is no ambiguity. The first pK_a (R—COOH) is 2.35 and the second pK_a (R—NH₃⁺) is 9.69. The isoelectric pH (pI) of alanine thus is

$$pI = \frac{pK_1 + pK_2}{2} = \frac{2.35 + 9.69}{2} = 6.02$$

For polyprotic acids, pI is also the pH midway between the pK_a values on either side of the isoionic species. For example, the pI for aspartic acid is

$$pI = \frac{pK_1 + pK_2}{2} = \frac{2.09 + 3.96}{2} = 3.02$$

For lysine, pI is calculated from:

$$pI = \frac{pK_2 + pK_3}{2}$$

Similar considerations apply to all polyprotic acids (eg, proteins), regardless of the number of dissociable groups present. In the clinical laboratory, knowledge of the pI guides selection of conditions for electrophoretic separations. Electrophoresis at pH 7.0 will separate two molecules with pI values of 6.0 and 8.0, because the molecule with a pI of 6.0 will have a net *positive* charge, and that with a pI of 8.0 a net *negative* charge. Similar considerations underlie chromatographic separations on ionic supports such as diethylaminoethyl (DEAE) cellulose (see [Chapter 4](#)).

pK_a Values Vary With the Environment

The environment of a dissociable group affects its pK_a ([Table 3–4](#)). A nonpolar environment, which possesses less capacity than water for stabilizing charged species, thus *raises* the pK_a of a carboxyl group making it a *weaker* acid, but *lowers* the pK_a of an amino group, making it a *stronger* acid. Similarly, the presence of an adjacent *oppositely* charged group can *stabilize*, or of a *similarly* charged group can *destabilize*, a developing charge. Therefore, the pK_a values of the R groups of *free* amino acids in aqueous solution (see [Table 3–1](#)) provide only an approximate guide to their pK_a values when present in proteins. The pK_a of a dissociable R group will depend on its location within a protein. pK_a values that diverge from aqueous solution by as much as 3 pH units are common at the active sites of enzymes. An extreme example, a buried aspartic acid of thioredoxin, has a pK_a above 9—a shift of more than 6 pH units!

TABLE 3–4 Typical Range of pK Values for Ionizable Groups in Proteins

Dissociating Group	pK _a Range
α-Carboxyl	3.5-4.0
Non-α COOH of Asp or Glu	4.0-4.8
Imidazole of His	6.5-7.4
SH of Cys	8.5-9.0
OH of Tyr	9.5-10.5
α-Amino	8.0-9.0
ε-Amino of Lys	9.8-10.4
Guanidinium of Arg	~12.0

The Solubility of Amino Acids Reflects Their Ionic Character

The charges conferred by the dissociable functional groups of amino acids ensure that they are readily solvated by—and thus soluble in—polar solvents such as water and ethanol, but insoluble in nonpolar solvents such as benzene, hexane, or ether.

Amino acids do not absorb visible light and thus are colorless. However, tyrosine, phenylalanine, and tryptophan absorb high-wavelength (250-290 nm) ultraviolet light. Because it absorbs ultraviolet light about 10 times more efficiently than either phenylalanine or tyrosine, tryptophan makes the major contribution to the ability of most proteins to absorb light in the region of 280 nm (**Figure 3–6**).

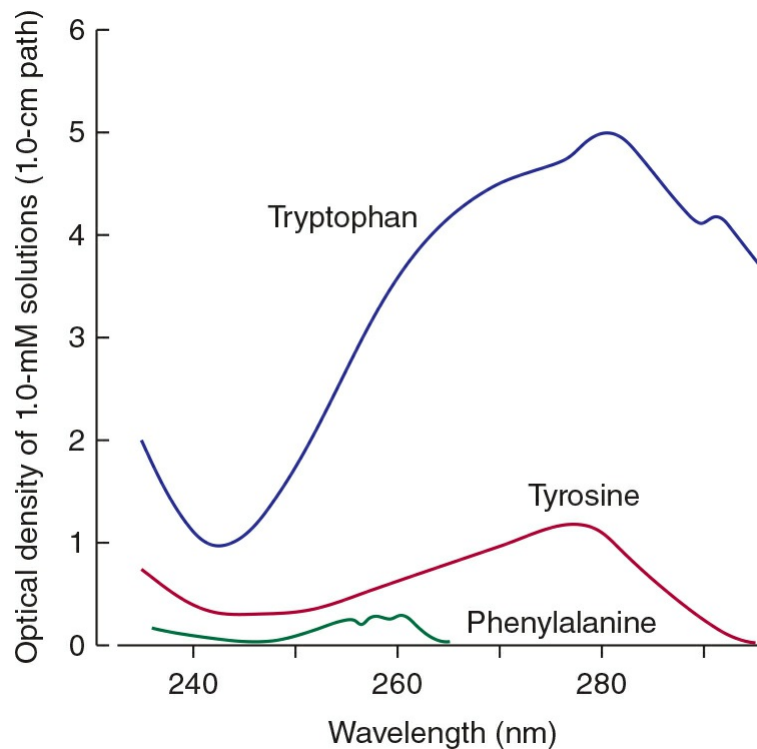

FIGURE 3–6 Ultraviolet absorption spectra of tryptophan, tyrosine, and phenylalanine.

THE α -R GROUPS DETERMINE THE PROPERTIES OF AMINO ACIDS

Each functional group of an amino acid exhibits all of its characteristic chemical reactions. For carboxylic acid groups, these reactions include the formation of esters, amides, and acid anhydrides; for amino groups, acylation, amidation, and esterification; and for —OH and —SH groups, oxidation and esterification. Since glycine, the smallest amino acid, can be accommodated in places inaccessible to other amino acids, it often occurs where peptides bend sharply. The hydrophobic R groups of alanine, valine, leucine, and isoleucine and the aromatic R groups of phenylalanine, tyrosine, and tryptophan typically occur primarily in the interior of cytosolic proteins. The charged R groups of basic and acidic amino acids stabilize specific protein conformations via ionic interactions, or salt bridges. These interactions also function in “charge relay” systems during enzymatic catalysis and electron transport in respiring mitochondria. Histidine plays unique roles in enzymatic catalysis. The pK_a of its imidazole proton permits histidine to function at neutral pH as either a base or an acid catalyst without the need for any environmentally induced shift. The primary alcohol group of serine and the primary thioalcohol (—

SH) group of cysteine are excellent nucleophiles, and can function as such during enzymatic catalysis. For selenocysteine, its pK_3 of 5.2 is 3 pH units lower than that of cysteine, 8.3. At a distinctly acidic pH, selenocysteine thus should be the better nucleophile. However, the secondary alcohol group of threonine, while a good nucleophile, is not known to serve this role in catalysis. The —OH groups of serine, tyrosine, and threonine frequently serve as the points of covalent attachment for phosphoryl groups that regulate protein function (see [Chapter 9](#)).

Amino Acid Sequence Determines Primary Structure

Amino acids are linked together by peptide bonds.

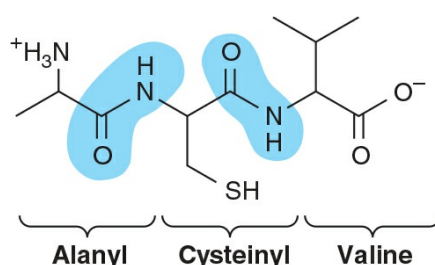

The *number* and *order* of the amino acid residues in a polypeptide constitute its *primary structure*. Amino acids present in peptides, called *aminoacyl residues*, are referred to by replacing the *ate* or *ine* suffixes of free amino acids with *yl* (eg, alanyl, aspartyl, tyrosyl). Peptides are then named as derivatives of the *carboxy* terminal aminoacyl residue. For example, Lys-Leu-Tyr-Gln is called lysyl-leucyl-tyrosyl-glutamine. The *ine* ending on the carboxy-terminal residue (eg, glutamine) indicates that its α -carboxyl group is *not* involved in a peptide bond. Three-letter abbreviations linked by straight lines represent an unambiguous primary structure. Lines are omitted when using single-letter abbreviations.

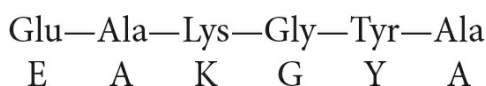

Prefixes like *tri-* or *octa-* denote peptides with three or eight *residues*, respectively. By convention, peptides are written with the residue that bears the free α -amino group at the left. This convention was adopted long before it was discovered that peptides are synthesized *in vivo* starting from the amino-terminal residue.

Peptide Structures Are Easy to Draw

To draw a peptide, use a zigzag to represent the main chain or backbone. Add the main chain atoms, which occur in the repeating order: α -nitrogen, α -carbon, carbonyl carbon. Now add a hydrogen atom to each α -carbon and to each peptide nitrogen, then add an oxygen to the carbonyl carbon. Finally, add the appropriate R groups (shaded) to each α -carbon atom.

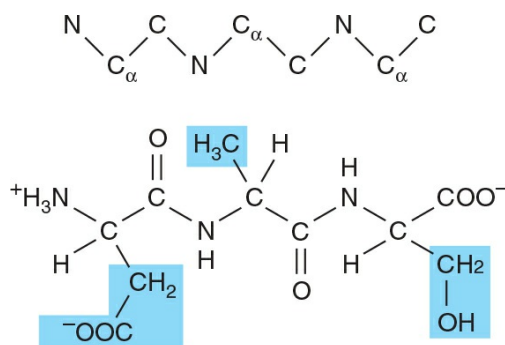

Some Peptides Contain Unusual Amino Acids

In mammals, peptide hormones typically contain only the 20 codon-specified α -amino acids linked by standard peptide bonds. Other peptides may, however, contain nonprotein amino acids, derivatives of the protein amino acids, or amino acids linked by an atypical peptide bond. For example, the amino terminal glutamate of glutathione, a tripeptide that participates in the metabolism of xenobiotics (see [Chapter 47](#)) and the reduction of disulfide bonds, is linked to cysteine by a non- α peptide bond ([Figure 3–7](#)). The amino terminal glutamate of thyrotropin-releasing hormone (TRH) is cyclized to pyroglutamic acid, and the carboxyl group of the carboxyl terminal prolyl residue is amidated. The nonprotein amino acids D-phenylalanine and ornithine are present in the cyclic peptide antibiotics tyrocidin and gramicidin S, while the heptapeptide opioids dermorphin and deltophorin in the skin of South American tree frogs contain D-tyrosine and D-alanine.

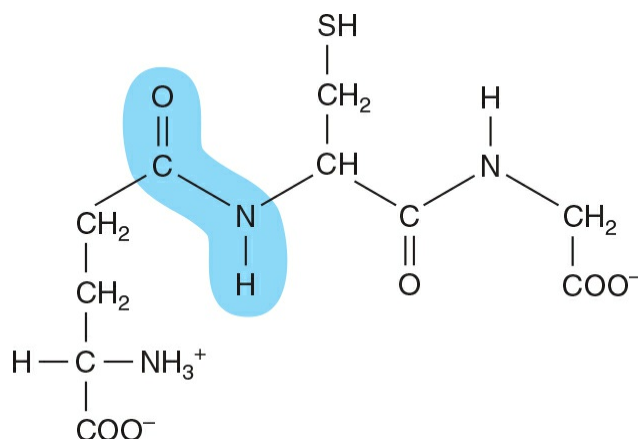
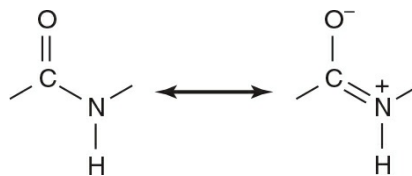

FIGURE 3–7 Glutathione (γ -glutamyl-cysteinyl-glycine). Note the non- α peptide bond that links Glu to Cys.

The Peptide Bond Has Partial Double-Bond Character

Although peptide structures are written as if a single bond linked the α -carboxyl and α -nitrogen atoms, this bond in fact exhibits partial double-bond character:



The bond that connects a carbonyl carbon to the α -nitrogen therefore cannot rotate, as this would require breaking the partial double bond. Consequently, the O, C, N, and H atoms of a peptide bond are *coplanar*. The imposed semirigidity of the peptide bond has important consequences for the manner in which peptides and proteins fold to generate higher orders of structure. Encircling brown arrows indicate free rotation about the remaining bonds of the polypeptide backbone (**Figure 3–8**).

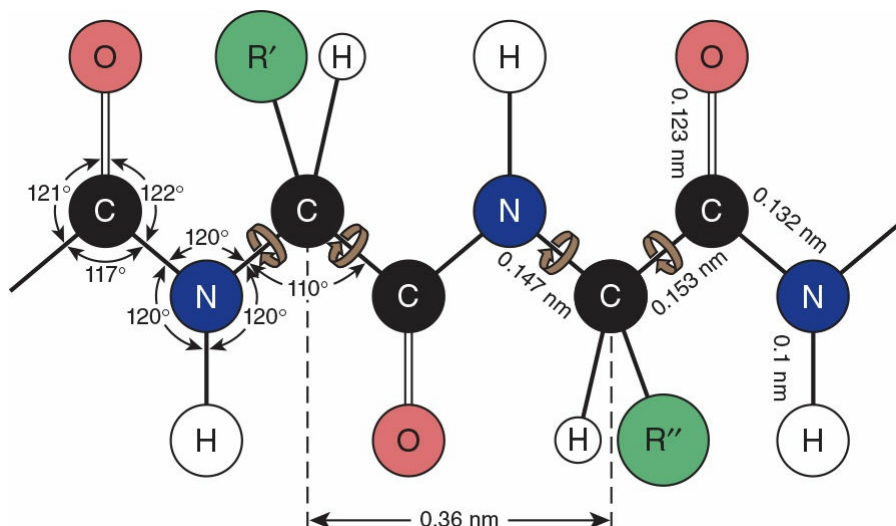

FIGURE 3–8 Dimensions of a fully extended polypeptide chain. The four atoms of the peptide bond are coplanar. Free rotation can occur about the bonds that connect the α -carbon with the α -nitrogen and with the α -carbonyl carbon (**brown arrows**). The extended polypeptide chain is thus a semirigid structure with two-thirds of the atoms of the backbone held in a fixed planar relationship to one another. The distance between adjacent

α -carbon atoms is 0.36 nm (3.6 Å). The interatomic distances and bond angles, which are not equivalent, are also shown. (Redrawn and reproduced, with permission, from Pauling L, Corey LP, Branson HR: The structure of proteins: two hydrogen-bonded helical configurations of the polypeptide chain. Proc Natl Acad Sci USA 1951;37:205.)

Noncovalent Forces Constrain Peptide Conformations

Folding of a peptide probably occurs coincident with its biosynthesis (see [Chapter 37](#)). The mature, physiologically active conformation reflects the collective contributions of the amino acid sequence, noncovalent interactions (eg, hydrogen bonding, hydrophobic interactions), and the minimization of steric hindrance between residues. Common repeating conformations include α -helices and β -pleated sheets (see [Chapter 5](#)).

Peptides Are Polyelectrolytes

The peptide bond is uncharged at any pH of physiologic interest. Formation of peptides from amino acids is therefore accompanied by a net loss of one positive and one negative charge per peptide bond formed. Peptides nevertheless are charged at physiologic pH, owing to their terminal carboxyl and amino groups and, where present, their acidic or basic R groups. As for amino acids, the net charge on a peptide depends on the pH of its environment and on the pK_a values of its dissociating groups.

SUMMARY

- Both D-amino acids and non- α -amino acids occur in nature, but proteins are synthesized using only L- α -amino acids. D-Amino acids do, however, serve metabolic roles, not only in bacteria, but also in humans.
- L- α -Amino acids serve vital metabolic functions in addition to protein synthesis. Examples include the biosynthesis of urea, heme, nucleic acids, and hormones such as epinephrine and DOPA.
- The presence in meteorites of trace quantities of many of the protein amino acids lends credence to the hypothesis that asteroid strikes might have contributed to the development of life on earth.
- Certain of the L- α -amino acids present in plants and plant seeds can have deleterious effects on human health, for example, in lathyrism.
- The R groups of amino acids determine their unique biochemical

functions. Amino acids are classified as basic, acidic, aromatic, aliphatic, or sulfur-containing based on the composition and properties of their R groups.

- The partial double-bond character of the bond that links the carbonyl carbon and the nitrogen of a peptide render the four atoms of the peptide bond *coplanar*, and hence restrict the number of possible peptide conformations.
- Peptides are named for the number of amino acid residues present, and as derivatives of the carboxyl terminal residue. The primary structure of a peptide is its amino acid sequence, starting from the amino-terminal residue, a direction in which peptides actually are synthesized *in vivo*.
- All amino acids possess at least two weakly acidic functional groups, $R-NH_3^+$ and $R-COOH$. Many also possess additional weakly acidic functional groups such as phenolic $-OH$, $-SH$, guanidino, or imidazole moieties.
- The pK_a values of all functional groups of an amino acid or of a peptide dictate its net charge at a given pH. pI , the isoelectric pH, is the pH at which an amino acid bears no net charge and thus does not move in a direct current electrical field.
- The pK_a values of free amino acids at best only approximates their pK_a values when present in a protein, and can differ widely due to the influence of their surroundings in a protein.

REFERENCES

- Bender DA: *Amino Acid Metabolism*, 3rd ed. Wiley, 2012.
- Burton AS, Stern JC, Elsila JE, et al: Understanding prebiotic chemistry through the analysis of extraterrestrial amino acids and nucleobases in meteorites. *Chem Soc Rev* 2012;41:5459.
- deMunck E, Muñoz-Sáez E, Miguel BG, et al: β -N-Methylamino-L-alanine causes neurological and pathological phenotypes mimicking amyotrophic lateral sclerosis (ALS): The first step towards an experimental model for sporadic ALS. *Environ Toxicol Pharmacol* 2013;36:243.
- Kolodkin-Gal I: D-Amino acids trigger biofilm disassembly. *Science* 2010;328:627.

Proteins: Determination of Primary Structure

Peter J. Kennelly, PhD & Victor W. Rodwell, PhD

OBJECTIVES

After studying this chapter, you should be able to:

- Cite three examples of posttranslational modifications that commonly occur during the maturation of a newly synthesized polypeptide.
- Name four chromatographic methods commonly employed for the isolation of proteins from biologic materials.
- Describe how electrophoresis in polyacrylamide gels can be used to determine the purity, subunit composition, relative mass, and isoelectric point of a protein.
- Describe the basis on which quadrupole and time-of-flight (TOF) spectrometers determine molecular mass.
- Compare the respective strengths and weaknesses of DNA cloning and mass spectrometry (MS) as tools for determining protein primary structure.
- Explain what is meant by “the proteome” and cite examples of its potential significance.

- Describe the advantages and limitations of gene chips as a tool for monitoring protein expression.
- Outline three strategies for resolving individual proteins and peptides from complex biologic samples to facilitate their identification by MS.
- Comment on the contributions of genomics, computer algorithms, and databases to the identification of the open reading frames (ORFs) that encode a given protein.

BIOMEDICAL IMPORTANCE

Proteins are physically and functionally complex macromolecules that perform multiple critically important roles. An internal protein network, the cytoskeleton (see [Chapter 51](#)) maintains a cell's shape and physical integrity. Actin and myosin filaments form the contractile machinery of muscle (see [Chapter 51](#)). Hemoglobin transports oxygen (see [Chapter 6](#)), while circulating antibodies defend against foreign invaders (see [Chapter 52](#)). Enzymes catalyze reactions that generate energy, synthesize and degrade biomolecules, replicate and transcribe genes, process mRNAs, etc (see [Chapter 7](#)). Receptors enable cells to sense and respond to hormones and other extracellular cues (see [Chapters 41](#) and [42](#)). Proteins are subject to physical and functional changes that mirror the life cycle of the organisms in which they reside. A typical protein is “born” at translation (see [Chapter 37](#)), matures through posttranslational processing events such as selective proteolysis (see [Chapters 9](#) and [37](#)), alternates between working and resting states through the intervention of regulatory factors (see [Chapter 9](#)), ages through oxidation, deamidation, etc (see [Chapter 58](#)), and “dies” when degraded to its component amino acids (see [Chapter 29](#)). An important goal of molecular medicine is to identify biomarkers such as proteins and/or modifications to proteins whose presence, absence, or deficiency is associated with specific physiologic states or diseases ([Figure 4–1](#)).

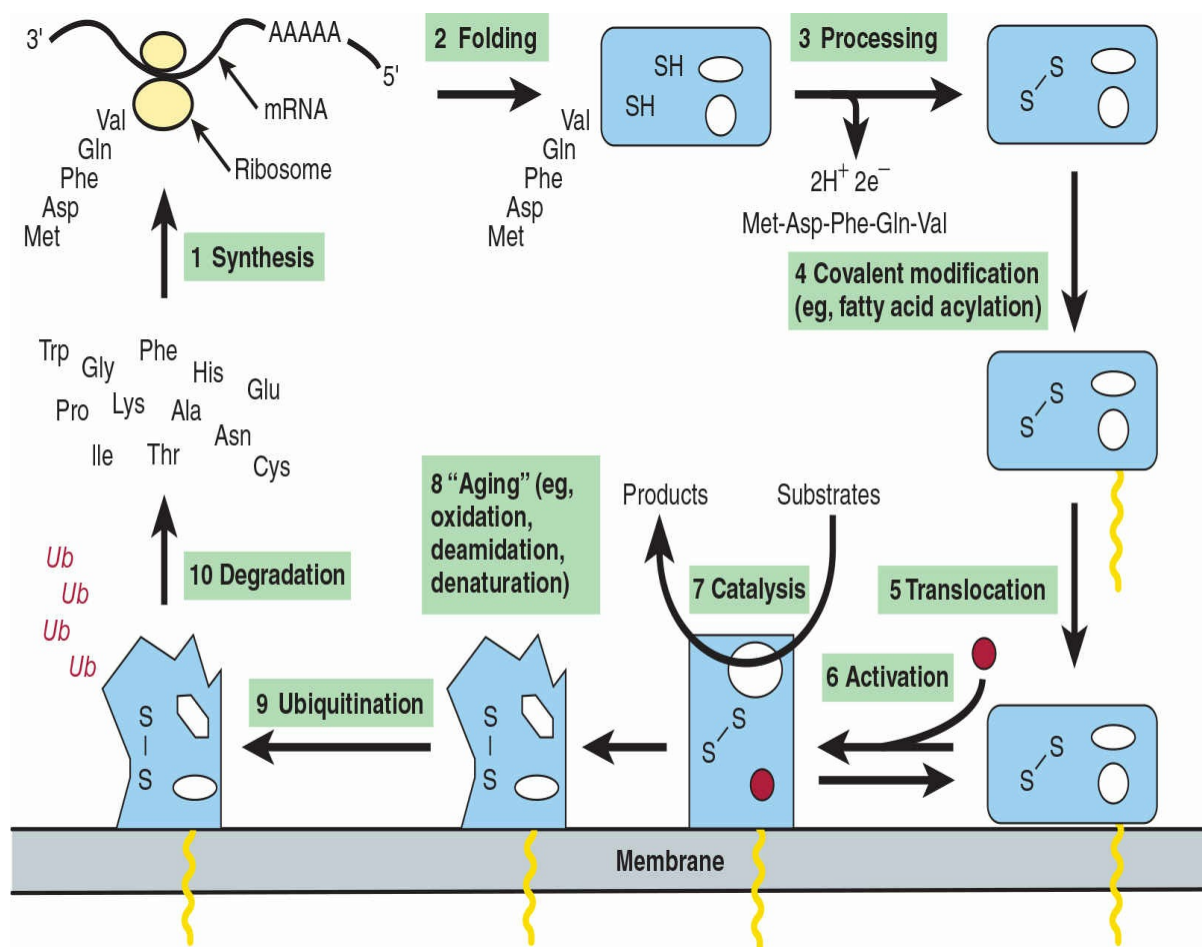

FIGURE 4–1 Diagrammatic representation of the life cycle of a hypothetical protein. (1) The life cycle begins with the synthesis on a ribosome of a polypeptide chain, whose primary structure is dictated by an mRNA. (2) As synthesis proceeds, the polypeptide begins to fold into its native conformation (blue). (3) Folding may be accompanied by processing events such as proteolytic cleavage of an *N*-terminal leader sequence (Met-Asp-Phe-Gln-Val) or the formation of disulfide bonds (S—S). (4) Subsequent covalent modifications may, for example, attach a fatty acid molecule (yellow) for (5) translocation of the modified protein to a membrane. (6) Binding an allosteric effector (red) may trigger the adoption of a catalytically active conformation. (7) Over time, proteins get damaged by chemical attack, deamidation, or denaturation, and (8) may be “labeled” by the covalent attachment of several ubiquitin molecules (*Ub*). (9) The ubiquitinated protein is subsequently degraded to its component amino acids, which become available for the synthesis of new proteins.

PROTEINS & PEPTIDES MUST BE PURIFIED PRIOR TO ANALYSIS

Highly purified protein is essential for the detailed examination of its physical and functional properties. Cells contain thousands of different proteins, each in widely varying amounts. The isolation of a specific protein in quantities sufficient for analysis of its properties thus presents a formidable challenge that may require successive application of multiple purification techniques. Selective precipitation exploits differences in relative solubility of individual proteins as a function of pH (isoelectric precipitation), polarity (precipitation with ethanol or acetone), or salt concentration (salting out with ammonium sulfate). Chromatographic techniques separate one protein from another based on the difference in their size (size-exclusion chromatography), charge (ion-exchange chromatography), hydrophobicity (hydrophobic interaction chromatography), or ability to bind a specific ligand (affinity chromatography).

Column Chromatography

In column chromatography, the stationary phase matrix consists of small beads loaded into a cylindrical container of glass, plastic, or steel called a column. Liquid-permeable frits confine the beads within this space while allowing the mobile-phase liquid to flow or percolate through the column. The stationary phase beads can be chemically derivatized to coat their surface with the acidic, basic, hydrophobic, or ligand-like groups required for ion exchange, hydrophobic interaction, or affinity chromatography. As the mobile-phase liquid emerges from the column, it is automatically collected as a series of small portions called fractions. **Figure 4–2** depicts the basic arrangement of a simple bench-top chromatography system.

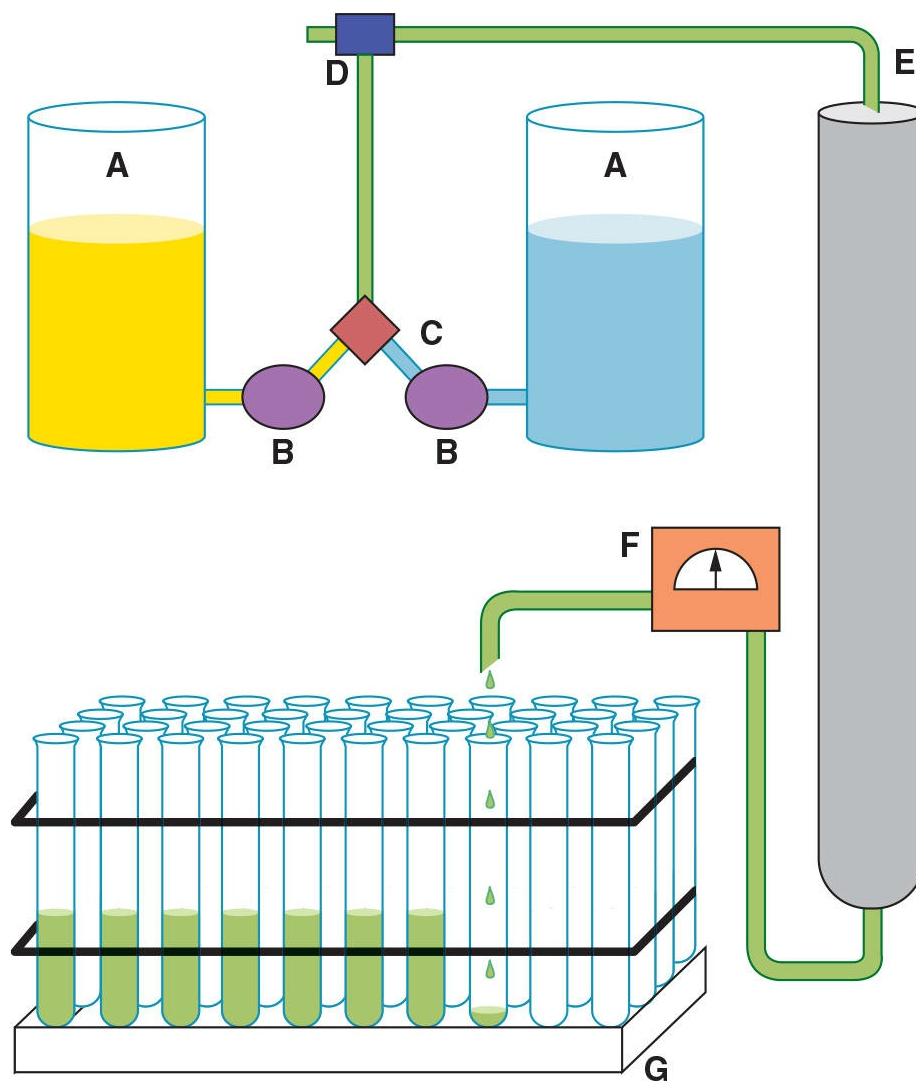

FIGURE 4–2 Components of a typical liquid chromatography apparatus. Shown are the key components of a programmable liquid chromatography system consisting of A: reservoirs of mobile-phase liquids (yellow, light blue), B: microprocessor-controlled pumps (purple), C: mixing chamber (red), D: injection port for loading analyte (dark blue); E: glass, metal, or plastic column containing stationary phase matrix (gray), F: spectrophotometric, fluorometric, refractive index, or electrochemical detector (orange), and G: fraction collector for collecting portions, called fractions, of the eluent liquid (green) in a series of separate test tubes, vials, or wells in a microtiter plate. The microprocessor can be programmed to pump liquid from only one reservoir (isocratic elution), to switch reservoirs at some predetermined point to generate a step gradient, or to mix liquids from the two reservoirs in proportions that vary over time to generate either a multistep or a continuous gradient.

HPLC—High-Pressure Liquid Chromatography

First-generation column chromatography matrices consisted of long, intertwined oligosaccharide polymers shaped into spherical beads roughly a tenth of a millimeter in diameter. Unfortunately, their relatively large size perturbed mobile-phase flow and limited the available surface area for accommodating added charged or ligand-like groups. Resolution could be increased by reducing particle size. However, the resistance created by a more tightly packed matrix required the use of very high pressures that would crush beads made from soft and spongy materials such as polysaccharide or acrylamide. Eventually, methods were developed to manufacture silicon particles of the necessary size and shape, to derivatize their surface with various functional groups, and to pack them into stainless steel columns capable of withstanding pressures of several thousand psi. Because of their greater resolving power, HPLC systems have largely displaced the once familiar glass columns in the protein purification laboratory.

Size-Exclusion Chromatography

Size-exclusion or, as it is sometimes still referred to, gelfiltration chromatography separates proteins on the basis of their **Stokes radii**. Stokes radius is a measure of the effective volume occupied by a protein as it rapidly tumbles in free solution. Stokes radius is thus a function of both molecular mass and shape. Like the propeller on an airplane, as it tumbles, an elongated protein occupies a larger effective volume than would a globular protein of the same mass. Size-exclusion chromatography employs porous beads (**Figure 4–3**) whose pores are analogous to indentations in a river bank. As objects move downstream, the motion of any object that enters an indentation is retarded until they drift back into the current. Similarly, proteins with Stokes radii too large to enter the pores (excluded proteins) remain in the flowing mobile phase, and emerge *before* proteins that can enter some or all of the pores (included proteins). Proteins thus emerge from a gel filtration column in *descending* order of their Stokes radii.

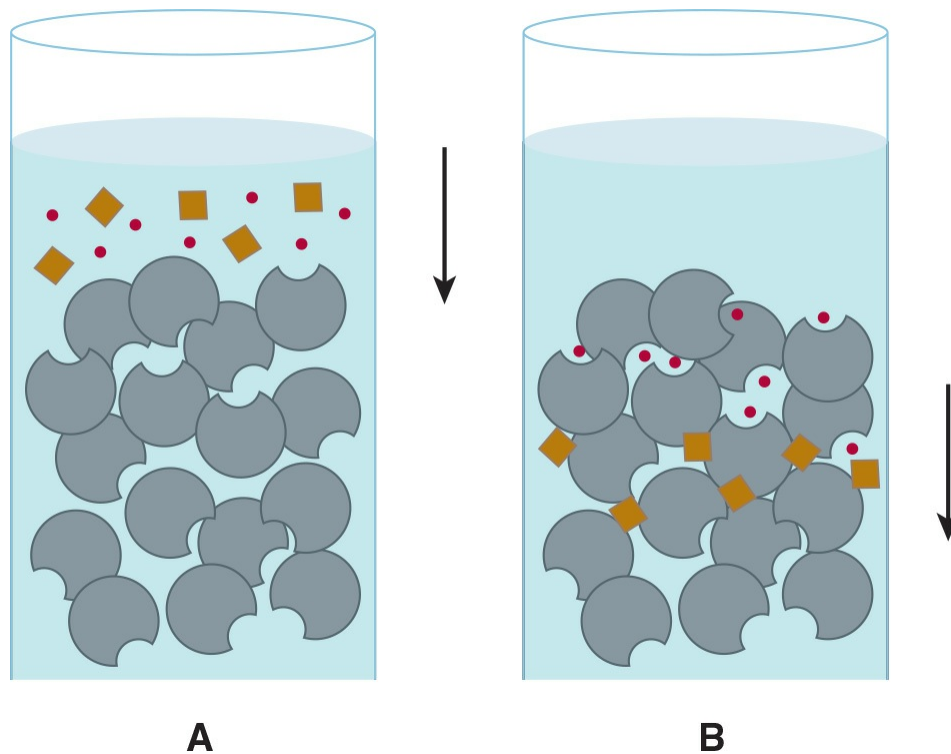

FIGURE 4-3 Size-exclusion chromatography. A: A mixture of large molecules (brown) and small molecules (red) is applied to the top of a gel filtration column. B: Upon entering the column, the small molecules enter pores in the stationary phase matrix (gray). As the mobile phase (blue) flows down the column, they lag behind from the large molecules, which are excluded.

Ion-Exchange Chromatography

In ion-exchange chromatography, proteins interact with the stationary phase by charge-charge interactions. Proteins with a net positive charge at a given pH will tightly adhere to beads with negatively charged functional groups such as carboxylates or sulfates (cation exchangers). Similarly, proteins with a net negative charge will adhere to beads with positively charged functional groups, typically tertiary or quaternary amines (anion exchangers). Nonadherent proteins flow through the matrix and are washed away. Bound proteins then are selectively displaced by gradually raising the ionic strength of the mobile phase, thereby weakening charge-charge interactions. Proteins elute in inverse order of the strength of their interactions with the stationary phase.

Hydrophobic Interaction Chromatography

Hydrophobic interaction chromatography separates proteins based on their

tendency to associate with a stationary phase matrix coated with hydrophobic groups (eg, phenyl Sepharose, octyl Sephadex). Proteins with exposed hydrophobic surfaces adhere to the matrix via hydrophobic interactions that are enhanced by employing a mobile phase of high ionic strength. After nonadherent proteins are washed away, the polarity of the mobile phase is decreased by gradually lowering its salt concentration. If the interaction between protein and stationary phase is particularly strong, ethanol or glycerol may be added to the mobile phase to decrease its polarity and further weaken hydrophobic interactions.

Affinity Chromatography

Affinity chromatography exploits the high selectivity displayed by most proteins for their ligands. Enzymes may be purified by affinity chromatography using immobilized substrates, products, coenzymes, or inhibitors. In theory, only proteins that interact with the immobilized ligand adhere. Bound proteins are then eluted either by competition with free, soluble ligand or, less selectively, by disrupting protein-ligand interactions using urea, guanidine hydrochloride, mildly acidic pH, or high salt concentrations. Stationary phase matrices containing analogs of frequently encountered ligands, such as NAD^+ or ATP, are commercially available. Recombinantly expressed proteins are frequently purified by using vectors that add a fusion domain onto the encoded protein designed to interact with a specific affinity matrix (see [Chapter 7](#)).

Protein Purity Is Assessed by Polyacrylamide Gel Electrophoresis (PAGE)

The most widely used method for determining the purity of a protein is SDS-PAGE—polyacrylamide gel electrophoresis (PAGE) in the presence of the anionic detergent sodium dodecyl sulfate (SDS). Electrophoresis separates charged biomolecules based on the rates at which they migrate in an applied electrical field. For SDS-PAGE, acrylamide is polymerized and cross-linked to form a porous matrix. SDS binds to proteins at a ratio of one molecule of SDS per two peptide bonds, causing the polypeptide to unfold or denature. When used in conjunction with 2-mercaptoethanol or dithiothreitol to reduce and break disulfide bonds ([Figure 4–4](#)), SDS-PAGE separates the component polypeptides of multimeric proteins. The large number of anionic SDS molecules, each bearing a charge of -1 , overwhelms the charge contributions of the amino acid functional groups

endogenous to a typical polypeptide. Since this renders the charge-to-mass ratio of each SDS-polypeptide complex approximately equal, the physical resistance each peptide encounters as it moves through the acrylamide matrix determines its rate of migration. Large complexes encounter greater resistance, causing polypeptides to separate based on their relative molecular mass (M_r). Individual polypeptides trapped in the acrylamide gel after removal of the electrical field are visualized by staining with dyes such as Coomassie Blue (**Figure 4–5**).

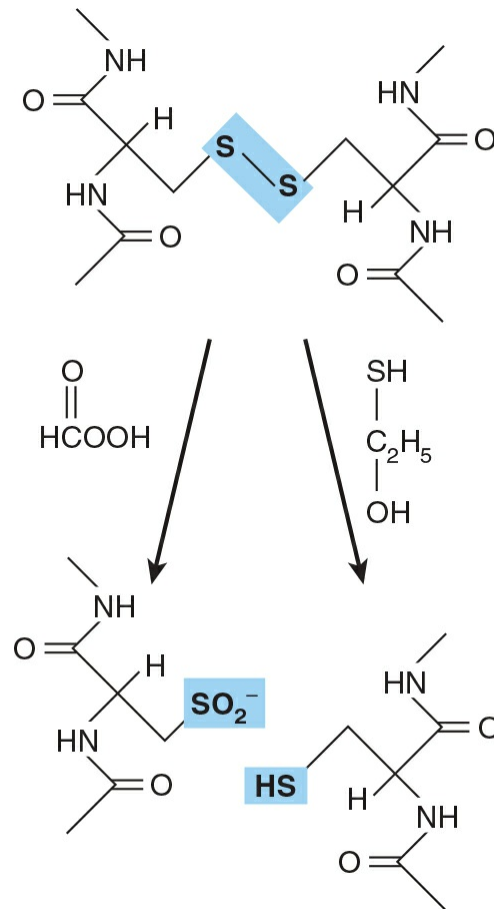

FIGURE 4–4 Oxidative cleavage of adjacent polypeptide chains linked by disulfide bonds (highlighted in blue) by performic acid (left) or reductive cleavage by β -mercaptoethanol (right) forms two peptides that contain cysteic acid residues or cysteinyl residues, respectively.

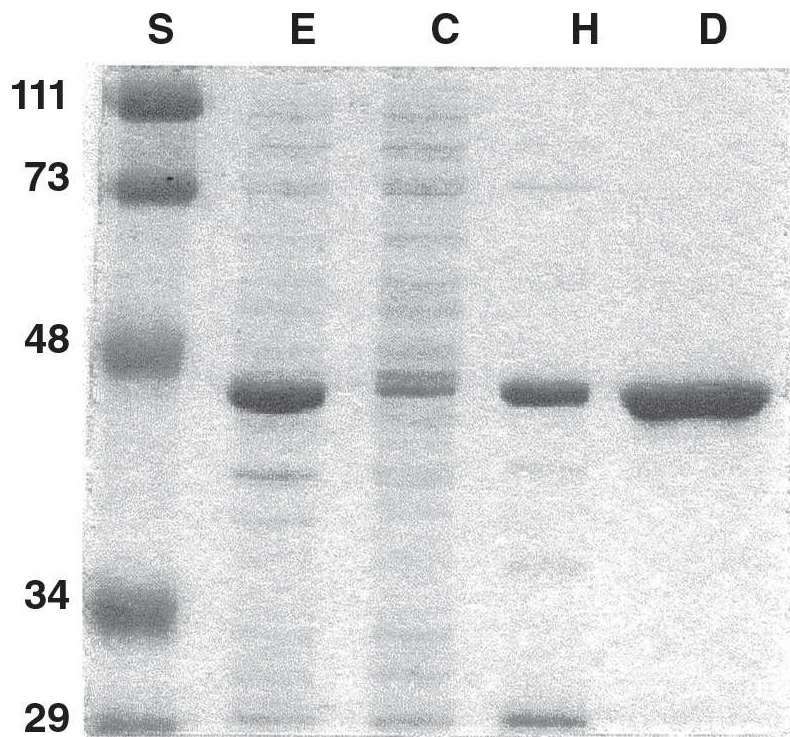

FIGURE 4–5 Use of SDS-PAGE to observe successive purification of a recombinant protein. The gel was stained with Coomassie Blue. Shown are protein standards (lane S) of the indicated M_r , in kDa, crude cell extract (E), cytosol (C), high-speed supernatant liquid (H), and the DEAE-Sephrose fraction (D). The recombinant protein has a mass of about 45 kDa.

Isoelectric Focusing (IEF)

Ionic buffers called ampholytes and an applied electric field are used to generate a pH gradient within a polyacrylamide matrix. Applied proteins migrate until they reach the region of the matrix where the pH matches their isoelectric point (pI), the pH at which a molecule's net charge is 0. IEF frequently is used in conjunction with SDS-PAGE for two-dimensional electrophoresis, which separates polypeptides based on pI in one dimension and on M_r in the second (**Figure 4–6**). Two-dimensional electrophoresis is particularly well suited for separating the components within complex mixtures of proteins.

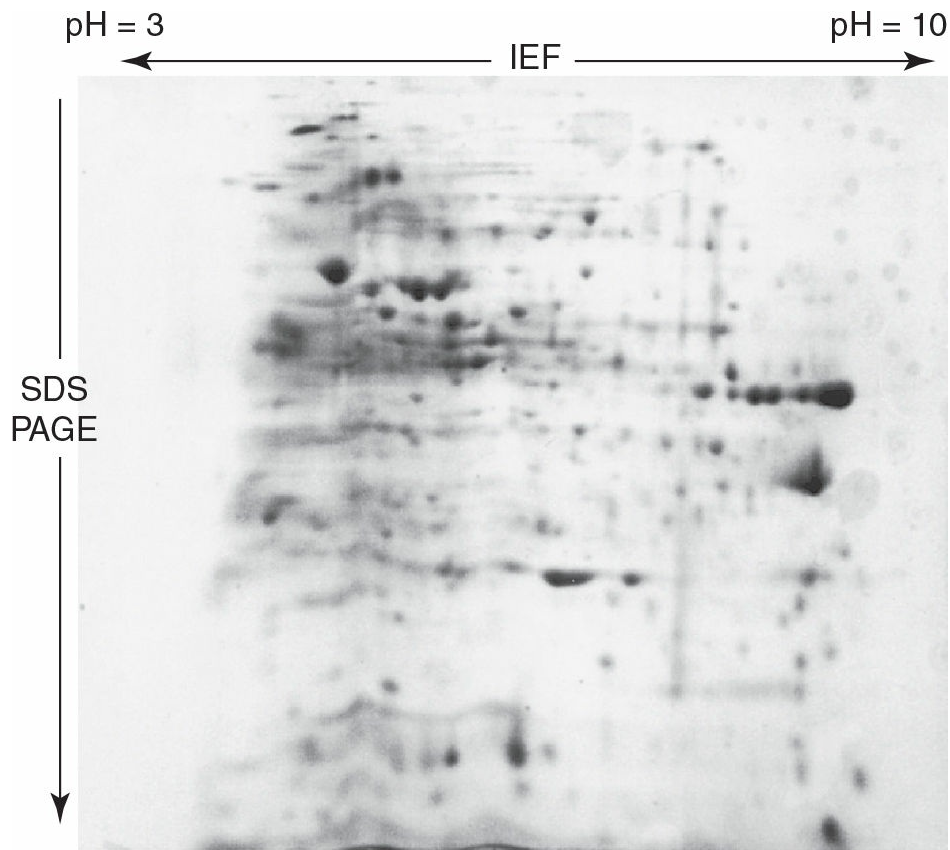

FIGURE 4-6 Two-dimensional IEF-SDS-PAGE. The gel was stained with Coomassie Blue. A crude bacterial extract was first subjected to isoelectric focusing (IEF) in a pH 3–10 gradient. The IEF gel was then placed horizontally on the top of an SDS-PAGE gel, and the proteins then further resolved by SDS-PAGE. Notice the greatly improved resolution of distinct polypeptides relative to ordinary SDS-PAGE gel (Figure 4-5).

SANGER WAS THE FIRST TO DETERMINE THE SEQUENCE OF A POLYPEPTIDE

Mature insulin consists of the 21-residue A chain and the 30-residue B chain linked by disulfide bonds. Frederick Sanger reduced the disulfide bonds (Figure 4-4), separated the A and B chains, and cleaved each chain into smaller peptides using trypsin, chymotrypsin, and pepsin. The resulting peptides were then isolated and hydrolyzed into a mixture of smaller peptides by treatment with acid. Each peptide in the mixture was isolated and treated with 1-fluoro-2,4-dinitrobenzene (Sanger reagent), which reacts with the exposed α -amino groups of the amino-terminal residues. The amino acid content of each peptide was then determined and the amino-terminal amino acid was identified. The ϵ -amino group of lysine also reacts with Sanger reagent; but since an amino-terminal lysine reacts

with 2 mol of Sanger reagent, it is readily distinguished from a lysine from the interior of a peptide. Working from di- and tripeptides up through progressively larger fragments, Sanger was able to reconstruct the complete sequence of insulin, an accomplishment for which he received a Nobel Prize in 1958. Sanger, who received his second Nobel prize for his development of techniques for DNA sequencing, died in 2013 at the age of 95.

THE EDMAN REACTION ENABLES PEPTIDES & PROTEINS TO BE SEQUENCED

Pehr Edman introduced phenyl isothiocyanate (Edman reagent) to selectively label the amino-terminal residue of a peptide. In contrast to Sanger reagent, the phenylthiohydantoin (PTH) derivative can be removed under mild conditions to generate a new amino-terminal residue (**Figure 4–7**). Successive rounds of derivatization with Edman reagent can therefore be used to sequence many residues of a single sample of peptide. Even with the benefit of Edman reagent, the determination of the complete sequence of a protein by chemical methods remains a time- and labor-intensive process.

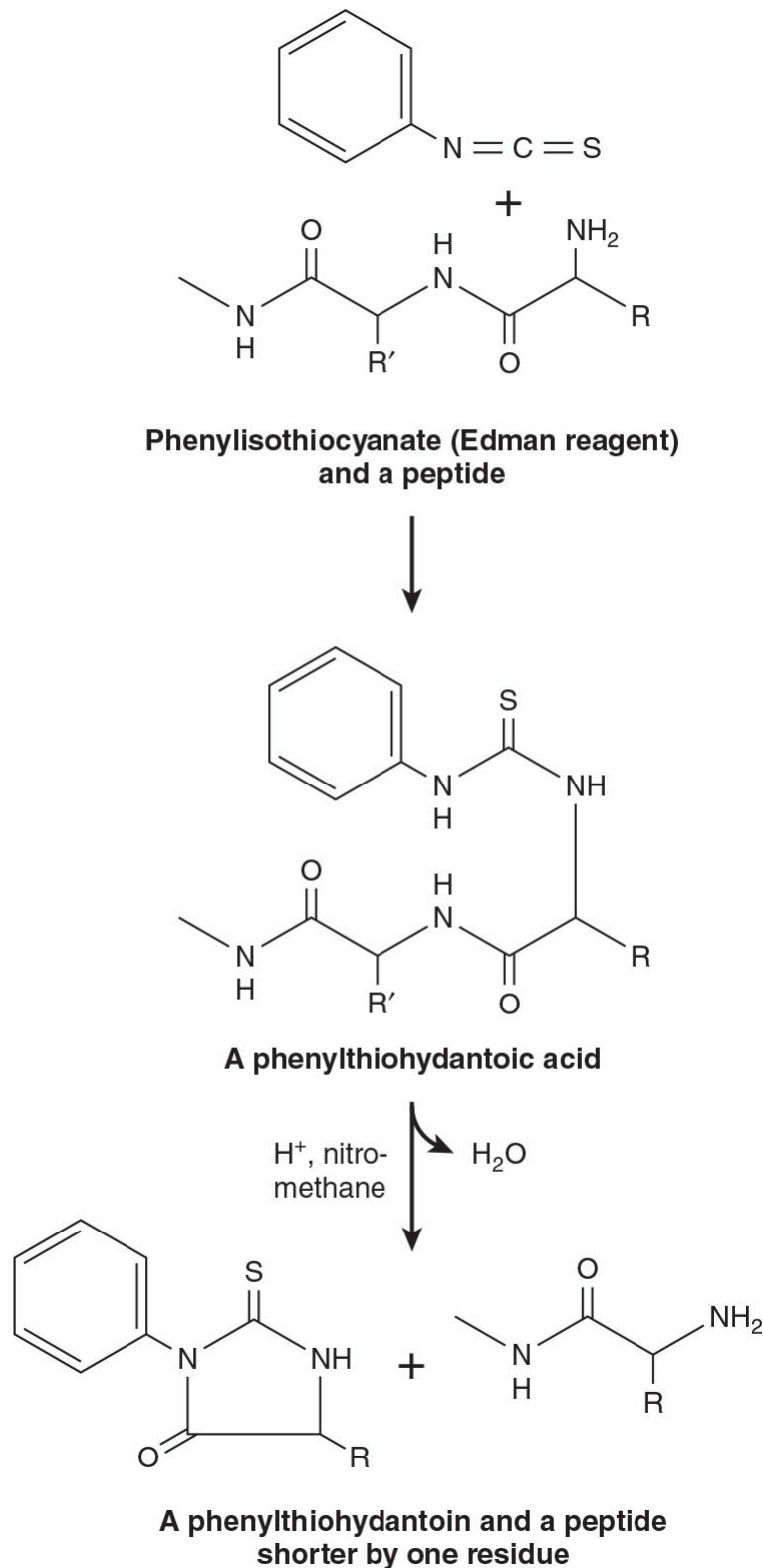

FIGURE 4-7 The Edman reaction. Phenyl isothiocyanate derivatizes the amino-terminal residue of a peptide as a phenylthiohydantoic acid. Treatment with acid in a nonhydroxylic solvent releases a phenylthiohydantoin, which is subsequently identified by its chromatographic mobility, and a peptide one residue shorter. The process

is then repeated.

The heterogeneous chemical properties of the amino acids meant that every step in the procedure represented a compromise between efficiency for any particular amino acid or set of amino acids and the flexibility needed to accommodate all 20. Consequently, each step in the process operates at less than 100% efficiency, which leads to the accumulation of polypeptide fragments with varying *N*-termini. Eventually, it becomes impossible to distinguish the correct PTH amino acid for that position in the peptide from the out-of-phase contaminants. As a result, the read length for Edman sequencing varies from 5 to 30 amino acid residues depending on the quantity and purity of the peptide.

In order to determine the complete sequence of a polypeptide several hundred residues in length, a protein must first be cleaved into smaller peptides, using either a protease or a reagent such as cyanogen bromide. Following purification by reversed-phase HPLC, these peptides are then analyzed by Edman sequencing. In order to assemble these short peptide sequences to solve the complete sequence of the intact polypeptide, it is necessary to analyze peptides whose sequences overlap one another. This is accomplished by generating multiple sets of peptides using more than one method of cleavage. The large quantities of purified protein required to test multiple protein fragmentation and peptide purification conditions constitute the second major drawback of direct chemical protein sequencing techniques.

MOLECULAR BIOLOGY REVOLUTIONIZED THE DETERMINATION OF PRIMARY STRUCTURE

While the reactions that sequentially derivatize and cleave PTH amino acids from the amino-terminal end of a peptide typically are conducted in an automated sequenator, DNA sequencing is far more rapid and economical. Recombinant techniques permit researchers to manufacture a virtually infinite supply of DNA from even minute quantities of template present in the original sample (see [Chapter 39](#)). DNA sequencing methods, whose underlying chemistry was also developed by Sanger, routinely enable automated sequencers to “read” sequences several thousand deoxyribonucleotides in length. The sequence of the encoded polypeptide is then determined by simply translating the sequence of nucleotide triplets encoded by its gene. Conversely, early molecular biologists designed

complementary oligonucleotide probes to identify the DNA clone containing the gene of interest by reversing this process and using a segment of chemically determined amino acid sequence as template. The advent of DNA cloning thus ushered in the widespread use of a hybrid approach in which Edman chemistry was employed to sequence a small portion of the protein, then exploiting this information to determine the remaining sequence by DNA cloning and polydeoxyribonucleotide sequencing.

GENOMICS ENABLES PROTEINS TO BE IDENTIFIED FROM SMALL AMOUNTS OF SEQUENCE DATA

Today the number of organisms for which the complete DNA sequence of their genomes has been determined and made available to the scientific community numbers in the thousands. Thus, for most research scientists, particularly those working on commonly used “model organisms” such as *Homo sapiens*, mouse, rat, *Escherichia coli*, *Drosophila melanogaster*, *Caenorhabditis elegans*, yeast, etc, the genetically encoded sequence of the protein(s) with which they are working has already been determined and lies waiting to be accessed in a database such as GenBank. All that a scientist needs to make an unambiguous identification is the amino acid sequence for some segment, sometimes as little as five or six consecutive residues, of the protein of interest. While the requisite amino acid sequence information once was obtained using the Edman technique, today mass spectrometry (MS) has emerged as the method of choice for protein identification.

MASS SPECTROMETRY CAN DETECT COVALENT MODIFICATIONS

The superior sensitivity, speed, and versatility of MS have replaced the Edman technique as the principal method for determining the sequences of peptides and proteins. MS is significantly more sensitive and tolerant of variations in sample quality. Moreover, since mass and charge are common properties of a wide range of biomolecules, MS can be used to analyze metabolites, carbohydrates, and lipids, and to detect posttranslational modifications such as phosphorylation or hydroxylation that add readily identified increments of mass to a protein (**Table 4–1**). These modifications are difficult to detect using the Edman technique and

are undetectable in the DNA-derived amino acid sequence.

TABLE 4–1 Mass Increases Resulting From Common Posttranslational Modifications

Modification	Mass Increase (Da)
Phosphorylation	80
Hydroxylation	16
Methylation	14
Acetylation	42
Myristylation	210
Palmitoylation	238
Glycosylation	162

MASS SPECTROMETERS COME IN VARIOUS CONFIGURATIONS

In a simple, single quadrupole mass spectrometer, a sample is placed under vacuum and allowed to vaporize in the presence of a proton donor to impart a positive charge. An electrical field then propels the cations toward a curved flight tube where they encounter a magnetic field, which deflects them at a right angle to their original direction of flight (**Figure 4–8**). The current powering the electromagnet that generates this field is gradually increased until the path of each ion is bent sufficiently to strike a detector mounted at the end of the flight tube. **For ions of identical net charge, the force required to bend their path to the same extent is proportionate to their mass.**

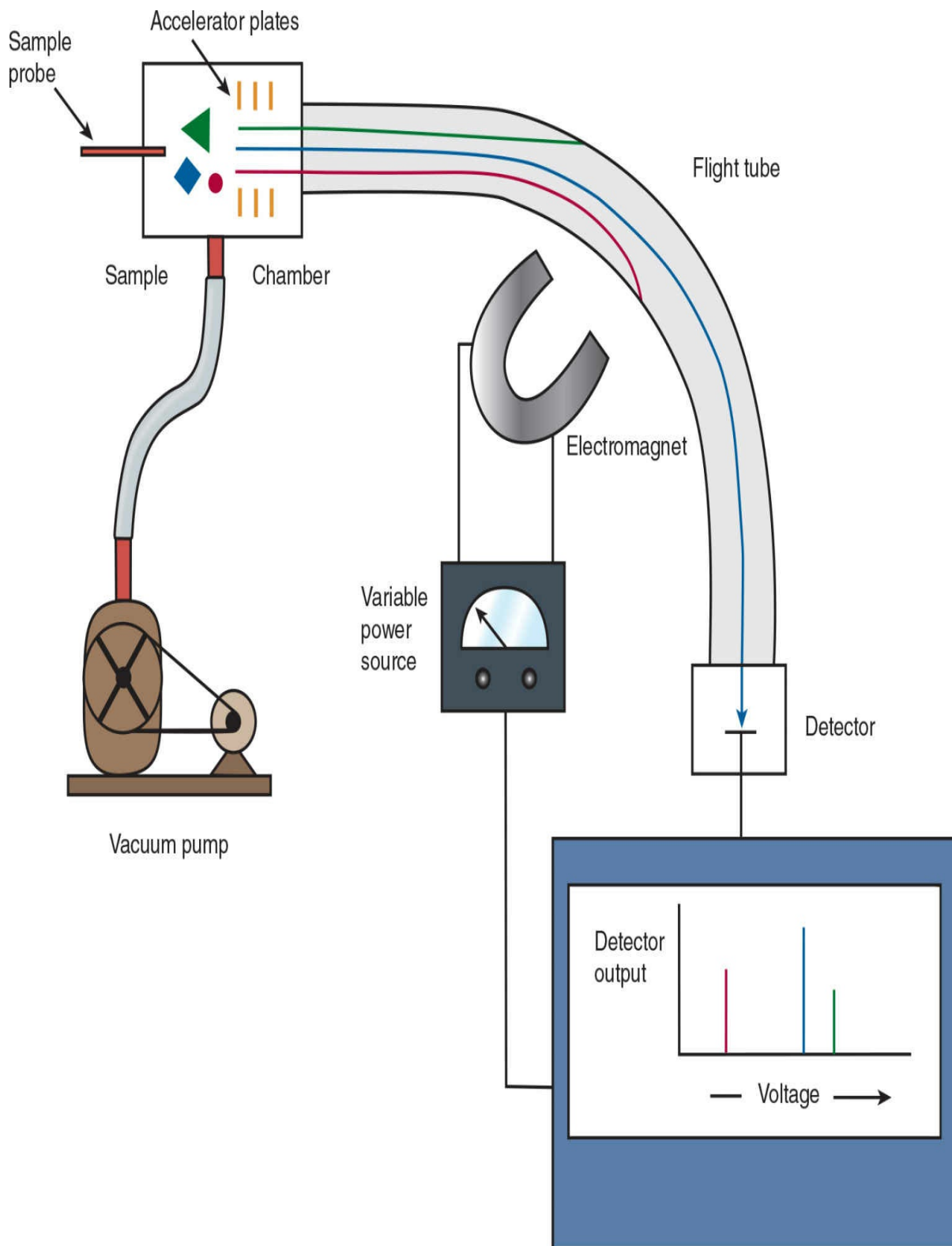

FIGURE 4-8 Basic components of a simple mass spectrometer. A mixture of molecules, represented by a red circle, green triangle, and blue diamond, is vaporized in an ionized state in the sample chamber. These molecules are then accelerated down the flight tube by an electrical potential applied to the accelerator grid (yellow). An adjustable field

strength electromagnet applies a magnetic field that deflects the flight of the individual ions until they strike the detector. The greater the mass of the ion, the higher the magnetic field required to focus it onto the detector.

Time-of-flight (TOF) mass spectrometers employ a linear flight tube. Following vaporization of the sample in the presence of a proton donor, an electric field is briefly applied to accelerate the ions toward a detector at the end of the flight tube. **For molecules of identical charge, the velocity to which they are accelerated, and hence the time required to reach the detector, is inversely proportional to their mass.**

Quadrupole mass spectrometers are generally used to determine the masses of molecules of 4000 Da or less, whereas TOF mass spectrometers are used to determine the large masses of complete proteins. Various combinations of multiple quadrupoles, or reflection of ions back down the linear flight tube of a TOF mass spectrometer, are used to create more sophisticated instruments.

Peptides Can Be Volatilized for Analysis by Electrospray Ionization or Matrix-Assisted Laser Desorption

The analysis of peptides and proteins by MS initially was hindered by difficulties in volatilizing these large organic molecules. While small organic molecules could be readily vaporized by heating in a vacuum (**Figure 4–9**), proteins, oligonucleotides, etc decomposed upon heating. Only when reliable techniques were devised for dispersing peptides, proteins, and other large biomolecules into the vapor phase it was possible to apply MS for their structural analysis and sequence determination. Three commonly used methods for dispersion into the vapor phase are **electrospray ionization, matrix-assisted laser desorption and ionization (MALDI), and fast atom bombardment (FAB)**. In electrospray ionization, the molecules to be analyzed are dissolved in a volatile solvent and introduced into the sample chamber in a minute stream through a capillary (**Figure 4–9**). As the droplet of liquid emerges into the sample chamber, the solvent rapidly disperses, leaving the macromolecule suspended in the gaseous phase. The charged probe serves to ionize the sample. Electrospray ionization is frequently used to analyze peptides and proteins as they elute from an HPLC or other chromatography column, already dissolved in a volatile solvent. In MALDI, the sample is mixed with a liquid matrix containing a light-absorbing dye and a source of

protons. In the sample chamber, the mixture is excited using a laser, causing the surrounding matrix to disperse into the vapor phase so rapidly as to avoid heating embedded peptides or proteins (Figure 4–9). In fast atom bombardment, large macromolecules dispersed in glycerol or another protonic matrix are bombarded by a stream of neutral atoms, for example, xenon, that have been accelerated to a high velocity. “Soft” ionization by FAB is frequently applied to volatilize large macromolecules intact.

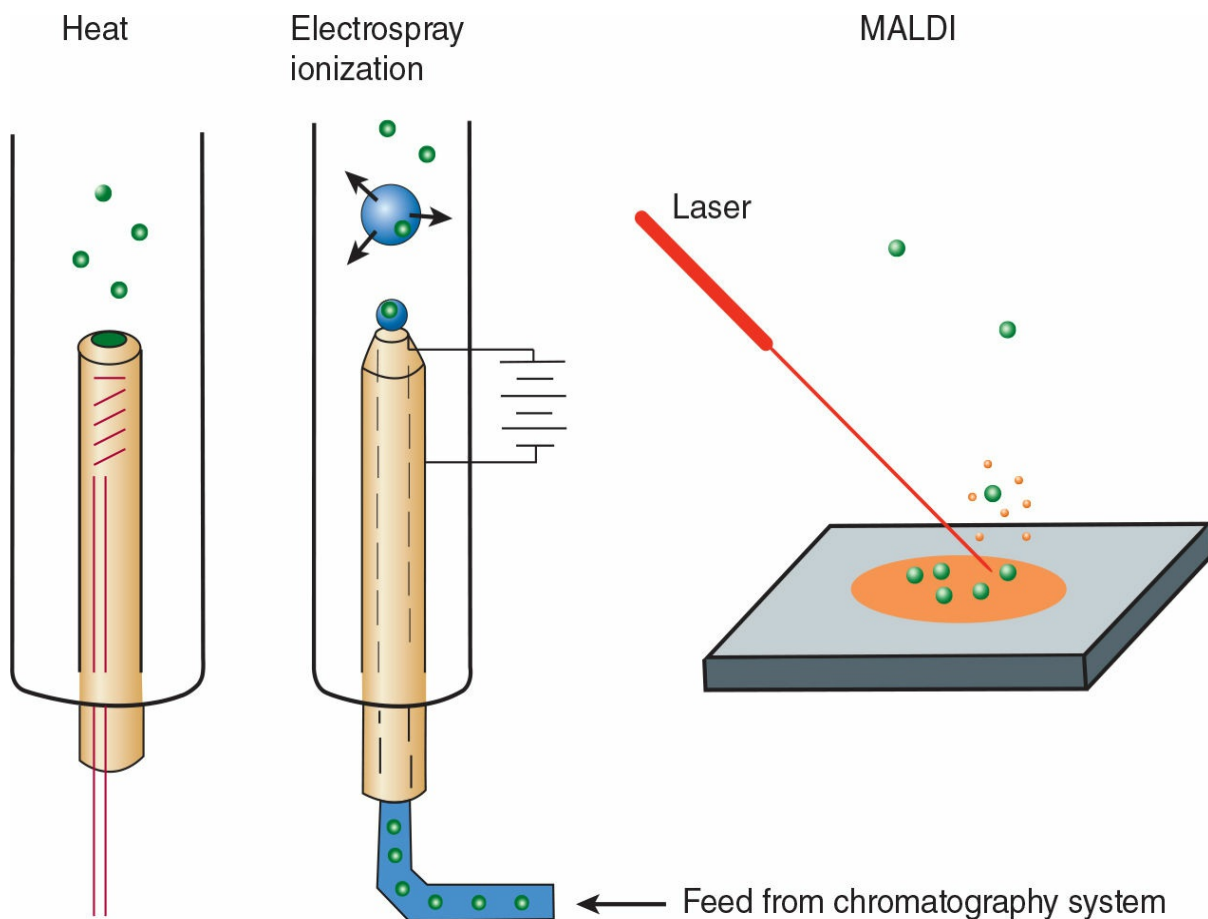

FIGURE 4–9 Three common methods for vaporizing molecules in the sample chamber of a mass spectrometer.

Peptides inside the mass spectrometer can be broken down into smaller units by collisions with neutral helium or argon atoms (collision-induced dissociation) and the masses of the individual fragments determined. Since peptide bonds are much more labile than carbon-carbon bonds, the most abundant fragments will differ from one another by increments of one or two amino acids. Since—with the exceptions of (1) leucine and isoleucine and (2) glutamine and lysine—the molecular mass of each amino acid is unique, the sequence of the peptide can be reconstructed from the masses of its fragments.

Tandem Mass Spectrometry

Complex peptide mixtures can be analyzed, without prior purification, by tandem MS, which employs the equivalent of two mass spectrometers linked in series. For this reason, analysis by tandem instruments is often referred to as **MS–MS**, or **MS²**. The first mass spectrometer separates individual peptides based on their differences in mass. By adjusting the field strength of the first magnet, a single peptide can be directed into the second mass spectrometer, where fragments are generated and their masses are determined. Alternatively, they can be held in an electromagnetic **ion trap** located between the two quadrupoles and selectively delivered to the second quadrupole instead of being lost when the first quadrupole is set to select ions of a different mass.

Tandem MS can be used to screen blood samples from newborns for the presence and concentrations of amino acids, fatty acids, and other metabolites. Abnormalities in metabolite levels can serve as diagnostic indicators for a variety of genetic disorders, such as phenylketonuria, ethylmalonic encephalopathy, and glutaric acidemia type 1.

PROTEOMICS & THE PROTEOME

The Goal of Proteomics Is to Identify the Entire Complement of Proteins Elaborated by a Cell Under Diverse Conditions

While the sequence of the human genome is known, the picture provided by genomics is both static and incomplete. As genes are switched on and off, proteins are synthesized in particular cell types at specific times of growth or differentiation and in response to external stimuli. Muscle cells express proteins not expressed by neural cells, and the type of subunits present in the hemoglobin tetramer undergo change pre- and postpartum. Many proteins undergo posttranslational modifications during maturation into functionally competent forms or as a means of regulating their properties. In order to obtain a more complete and dynamic molecular description of living organisms, scientists are working to determine the **proteome**, a term that refers to the identity, abundance, and state of modification of the entire suite of proteins expressed by an individual cell at a particular time. Since the proteome for each component cell of an organism is distinct and changes with time and circumstances, the ultimate, comprehensive human proteome constitutes a target of

formidable size and complexity.

Simultaneous Determination of Hundreds of Proteins Is Technically Challenging

A key goal of proteomics is the identification of proteins whose levels of expression or modification correlate with medically significant events. In addition to their potential as diagnostic indicators, these protein biomarkers may provide important clues concerning the root causes and mechanisms of a specific physiologic condition or disease. First-generation proteomics employed SDS-PAGE or two-dimensional electrophoresis to resolve the proteins in one biologic sample from another, followed by determination of the amino acid sequence of their amino terminus by the Edman method. Identities were determined by searching available polypeptide sequences for proteins that contained a matching *N*-terminal sequence and were predicted to possess a similar M_r and, for 2D gels, pI.

These early efforts were constrained by the limited number of polypeptide sequences available and the difficulties in isolating polypeptides from the gels in sufficient quantities for Edman analysis. Attempts to increase resolving power and sample yield by increasing the size of the gels were only marginally successful. Eventually, the development of mass spectrometric techniques provided a means for protein sequence determination whose sensitivity was compatible with electrophoretic separation approaches.

Knowledge of the genome sequence of the organism in question greatly facilitated identification by providing a comprehensive set of DNA-encoded polypeptide sequences. It also provided the nucleotide sequence data from which to construct **gene arrays, sometimes called DNA chips**, containing hundreds of distinct oligonucleotide probes. These chips could then be used to detect the presence of mRNAs containing complementary nucleotide sequences. While changes in the expression of the mRNA encoding a protein do not necessarily reflect comparable changes in the level of the corresponding protein, gene arrays were both less technically demanding and more sensitive than first-generation proteomic approaches, particularly with respect to low abundance proteins.

Second-generation proteomics coupled newly developed nanoscale chromatographic techniques with MS. The proteins in a biologic sample are first treated with a protease to hydrolyze them into smaller peptides

that are then subject to reversed-phase, ion-exchange, or size-exclusion chromatography to apportion the vast number of peptides into smaller subsets more amenable to analysis. These subsets are analyzed by injecting the column eluent directly into a double quadrupole or TOF mass spectrometer. **Multidimensional protein identification technology (MudPIT)** employs successive rounds of chromatography to resolve the peptides produced from the digestion of a complex biologic sample into several simpler fractions that can be analyzed separately by MS.

Today, the suspension of complex peptide mixtures within the mass spectrometer itself and subsequently exporting small subsets for final analysis using ion traps often enables even complex mixtures to be analyzed directly by MS without prior chromatographic fractionation. Efforts also continue to refine methods for analysis of mRNA and protein expression in individual cells.

Bioinformatics Assists Identification of Protein Functions

The functions of a large proportion of the proteins encoded by the human genome are presently unknown. Efforts continue to develop protein arrays or chips for directly testing the potential functions of proteins on a mass scale. However, while some protein functions are relatively easy to assay, such as protease or esterase activity, others are much less tractable. Data mining via bioinformatics permits researchers to compare amino acid sequences of unknown proteins with those whose functions have been determined. This provides a means to uncover clues to their potential properties, physiologic roles, and mechanisms of action. Algorithms exploit the tendency of nature to employ variations of a structural theme to perform similar functions in several proteins [eg, the Rossmann nucleotide binding fold to bind NAD(P)H, nuclear targeting sequences, and EF hands to bind Ca^{2+}]. These domains generally are detected in the primary structure by conservation of particular amino acids at key positions. Insights into the properties and physiologic role of a newly discovered protein thus may be inferred by comparing its primary structure with that of known proteins.

SUMMARY

- Long amino acid polymers or polypeptides constitute the basic structural unit of proteins, and the structure of a protein provides

insight into how it fulfills its functions.

- Proteins undergo posttranslational alterations during their lifetime that influence their function and determine their fate.
- By generating a new amino terminus, Edman reagent permitted the determination of lengthy segments of amino acid sequence.
- Polyacrylamide gels provide a porous matrix for separating proteins on the basis of their mobility in an applied direct current electrical field.
- The nearly constant ratio at which the anionic detergent SDS binds proteins enables SDS-PAGE to separate polypeptides predominantly on the basis of relative size.
- Because mass is a universal property of all biomolecules and their derivatives, MS has emerged as a versatile technique applicable to the determination of primary structure, identification of posttranslational modifications, and the detection of metabolic abnormalities.
- DNA cloning coupled with protein chemistry provided a hybrid approach that greatly increased the speed and efficiency for determination of primary structures of proteins.
- Genomics, the determination of entire polynucleotide sequences, provides researchers with a blueprint for every genetically encoded macromolecule in an organism.
- Proteomic analysis utilizes genomic data to identify the entire complement of proteins in a biologic sample from partial amino acid sequence data obtained by coupling protein and peptide separation methods with sequencing by MS.
- A major goal of proteomics is the identification of proteins and their posttranslational modifications whose appearance or disappearance correlates with physiologic phenomena, aging, or specific diseases.
- Bioinformatics refers to the development of computer algorithms designed to infer the functional properties of macromolecules through comparison of sequences of novel proteins with others whose properties are known.

REFERENCES

- Biemann K: Laying the groundwork for proteomics: Mass spectrometry from 1958 to 1988. *J Proteomics* 2014;107:62.
- Deutscher MP (editor): *Guide to Protein Purification*. *Methods Enzymol*, vol. 182, Academic Press, 1990 (Entire volume).

- Duarte TT, Spencer CT: Personalized proteomics: The future of precision medicine. *Proteomes* 2016;4:29.
- Ghafourian S, Sekawi Z, Raftari M, et al: Application of proteomics in lab diagnosis. *Clin Lab* 2013;59:465.
- Schena M, Shalon D, Davis RW, et al: Quantitative monitoring of gene expression patterns with a complementary DNA microarray. *Science* 1995;270:467.
- Scopes RK: *Protein Purification. Principles and Practice*, 3rd ed. Springer, 1994.
- Sun H, Chen GY, Yao SQ: Recent advances in microarray technologies for proteomics. *Chem Biol* 2013;20:685.
- Van Riper SK, de Jong EP, Carlis JV, et al: Mass spectrometry-based proteomics: Basic principles and emerging technologies and directions. *Adv Exp Med Biol* 2013;990:1.
- Wood DW: New trends and affinity tag designs for recombinant protein purification. *Curr Opin Struct Biol* 2014;26:54.
- Zhu H, Qian J: Applications of functional protein microarrays in basic and clinical research. *Adv Genet* 2012;79:123.

Proteins: Higher Orders of Structure

Peter J. Kennelly, PhD & Victor W. Rodwell, PhD

OBJECTIVES

After studying this chapter, you should be able to:

- Indicate the advantages and drawbacks of several approaches to classifying proteins.
- Explain and illustrate the primary, secondary, tertiary, and quaternary structure of proteins.
- Identify the major recognized types of secondary structure and explain supersecondary motifs.
- Describe the kind and relative strengths of the forces that stabilize each order of protein structure.
- Describe the information summarized by a Ramachandran plot.
- Summarize the basic operating principles underlying three key methods for determining protein structure: X-ray crystallography, nuclear magnetic resonance spectroscopy, and cryo-electron microscopy.
- Indicate the present state of knowledge concerning the stepwise process by which proteins are thought to attain their native

conformation.

- Identify the physiologic roles in protein maturation of chaperones, protein disulfide isomerase, and peptidylproline *cis-trans* isomerase.
- Describe the principal biophysical techniques used to study tertiary and quaternary structure of proteins.
- Explain how genetic and nutritional disorders of collagen maturation illustrate the close linkage between protein structure and function.
- For the prion diseases, outline the overall events in their molecular pathology and name the life forms each affects.

BIOMEDICAL IMPORTANCE

In nature, form follows function. In order for a newly synthesized polypeptide to mature into a biologically functional protein capable of catalyzing a metabolic reaction, powering cellular motion, or forming the macromolecular rods and cables that provide structural integrity to hair, bones, tendons, and teeth, it must fold into a specific three-dimensional arrangement, or **conformation**. In addition, during maturation, **posttranslational modifications** may add new chemical groups or remove transiently needed peptide segments. Genetic or nutritional deficiencies that impede protein maturation are deleterious to health. Examples of the former include Creutzfeldt-Jakob disease, scrapie, Alzheimer disease, and bovine spongiform encephalopathy (“mad cow disease”). Examples of the latter include scurvy (ascorbic acid) and Menkes syndrome (Cu). Conversely, next generation therapeutics for viral diseases such as hepatitis C block the maturation of virally encoded proteins by inhibiting the activity of the cyclophilins, a family of peptidyl protein *cis-trans* isomerases.

CONFORMATION VERSUS CONFIGURATION

The terms configuration and conformation are often confused.

Configuration refers to the geometric relationship between a given set of atoms, for example, those that distinguish L- from D-amino acids.

Interconversion of *configurational* alternatives requires breaking (and reforming) covalent bonds. **Conformation** refers to the spatial relationship of every atom in a molecule. Interconversion between *conformers* occurs

with retention of configuration, generally via rotation about single bonds.

PROTEINS WERE INITIALLY CLASSIFIED BY THEIR GROSS CHARACTERISTICS

Scientists initially approached the elucidation of structure–function relationships in proteins by separating them into classes based on properties such as solubility, shape, or the presence of nonprotein groups. For example, the proteins that can be extracted from cells using aqueous solutions of physiologic pH and ionic strength are classified as **soluble**. Extraction of **integral membrane proteins** requires dissolution of the membrane with detergents. **Globular proteins** are compact, roughly spherical molecules that have **axial ratios** (the ratio of their shortest to longest dimensions) of not over three. Most enzymes are globular proteins. By contrast, many structural proteins adopt highly extended conformations. These **fibrous proteins** may possess axial ratios of 10 or more.

Lipoproteins and **glycoproteins** contain covalently bound lipid and carbohydrate, respectively. Myoglobin, hemoglobin, cytochromes, and many other **metalloproteins** contain tightly associated metal ions. While more precise classification schemes have emerged based on similarity, or **homology**, in amino acid sequence and three-dimensional structure, many early classification terms remain in use.

PROTEINS ARE CONSTRUCTED USING MODULAR PRINCIPLES

Proteins perform complex physical and catalytic functions by positioning specific chemical groups in a precise three-dimensional arrangement. The polypeptide scaffold containing these groups must adopt a conformation that is both functionally efficient and physically strong. At first glance, the biosynthesis of polypeptides comprised of tens of thousands of individual atoms would appear to be extremely challenging. When one considers that a typical polypeptide can potentially adopt $\geq 10^{50}$ distinct conformations, folding into the conformation appropriate to their biologic function would appear to be even more difficult. As described in [Chapters 3 and 4](#), synthesis of the polypeptide backbones of proteins employs a small set of common building blocks or modules, the amino acids, joined by a common linkage, the peptide bond. Similarly, a stepwise modular pathway simplifies the folding and processing of newly synthesized polypeptides

into mature proteins.

FOUR ORDERS OF PROTEIN STRUCTURE

The modular nature of protein synthesis and folding are embodied in the concept of orders of protein structure: **primary structure**—the sequence of amino acids in a polypeptide chain; **secondary structure**—the folding of short (3-30 residue), contiguous segments of polypeptide into geometrically ordered units; **tertiary structure**—the assembly of secondary structural units into larger functional units such as the mature polypeptide and its component domains; and **quaternary structure**—the number and types of polypeptide units of oligomeric proteins and their spatial arrangement.

SECONDARY STRUCTURE

Peptide Bonds Restrict Possible Secondary Conformations

Free rotation is possible about only two of the three types of covalent bonds comprising the polypeptide backbone: the bond linking the α -carbon ($C\alpha$) to the carbonyl carbon ($C\alpha$) and the bond linking $C\alpha$ to nitrogen (see [Figure 3–8](#)). The partial double-bond character of the peptide bond that links $C\alpha$ to the α -nitrogen requires that the carbonyl carbon, carbonyl oxygen, and α -nitrogen remain coplanar, thus preventing rotation. The angle about the $C\alpha$ —N bond is termed the phi (ϕ) angle, and that about the $C\alpha$ — $C\alpha$ bond the psi (ψ) angle. In peptides, for amino acids other than glycine, most combinations of phi and psi angles are disallowed because of steric hindrance ([Figure 5–1](#)). The conformations of proline are even more restricted as its cyclic structure prevents free rotation of the N— $C\alpha$ bond.

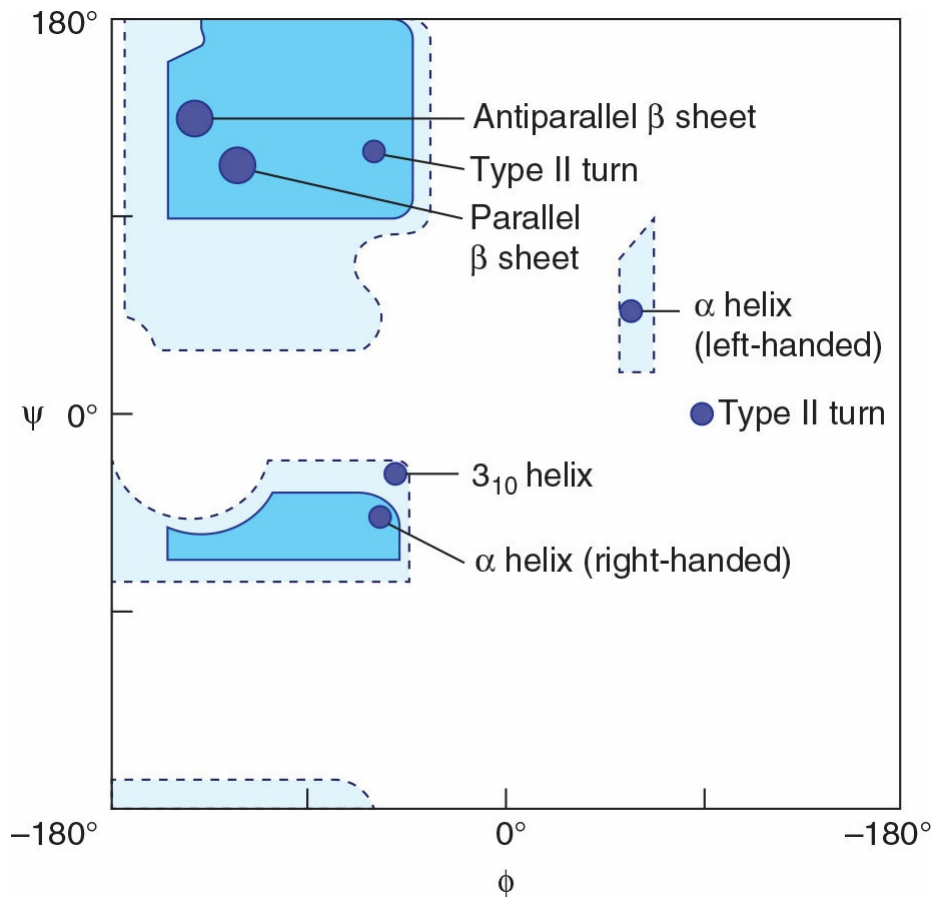

FIGURE 5–1 Ramachandran plot. The blue regions indicate sterically permissible combinations of phi–psi angles for nonglycine and nonproline amino acids in a polypeptide chain. The deeper the blue, the more thermodynamically favorable the phi–psi combination. Phi–psi angles corresponding to specific types of secondary structures are labeled.

Regions of ordered secondary structure arise when a series of aminoacyl residues adopt similar phi and psi angles. Extended segments of polypeptide (eg, loops) can possess a variety of such angles. The angles that define the two most common types of secondary structure, the **α helix** and the **β sheet**, fall within the lower and upper left-hand quadrants of a Ramachandran plot, respectively (Figure 5–1).

Alpha Helix

The polypeptide backbone of an **α helix** is twisted by an equal amount about each **α-carbon** with a phi angle of approximately -57° and a psi angle of approximately -47° . A complete turn of the helix contains an average of 3.6 aminoacyl residues, and the distance it rises per turn (its *pitch*) is 0.54 nm (Figure 5–2). The R groups of each aminoacyl residue in

an α helix face outward (**Figure 5–3**). Proteins contain only L-amino acids, for which a right-handed α helix is by far the more stable, and only right-handed α helices are present in proteins. Schematic diagrams of proteins represent α helices as coils or cylinders.

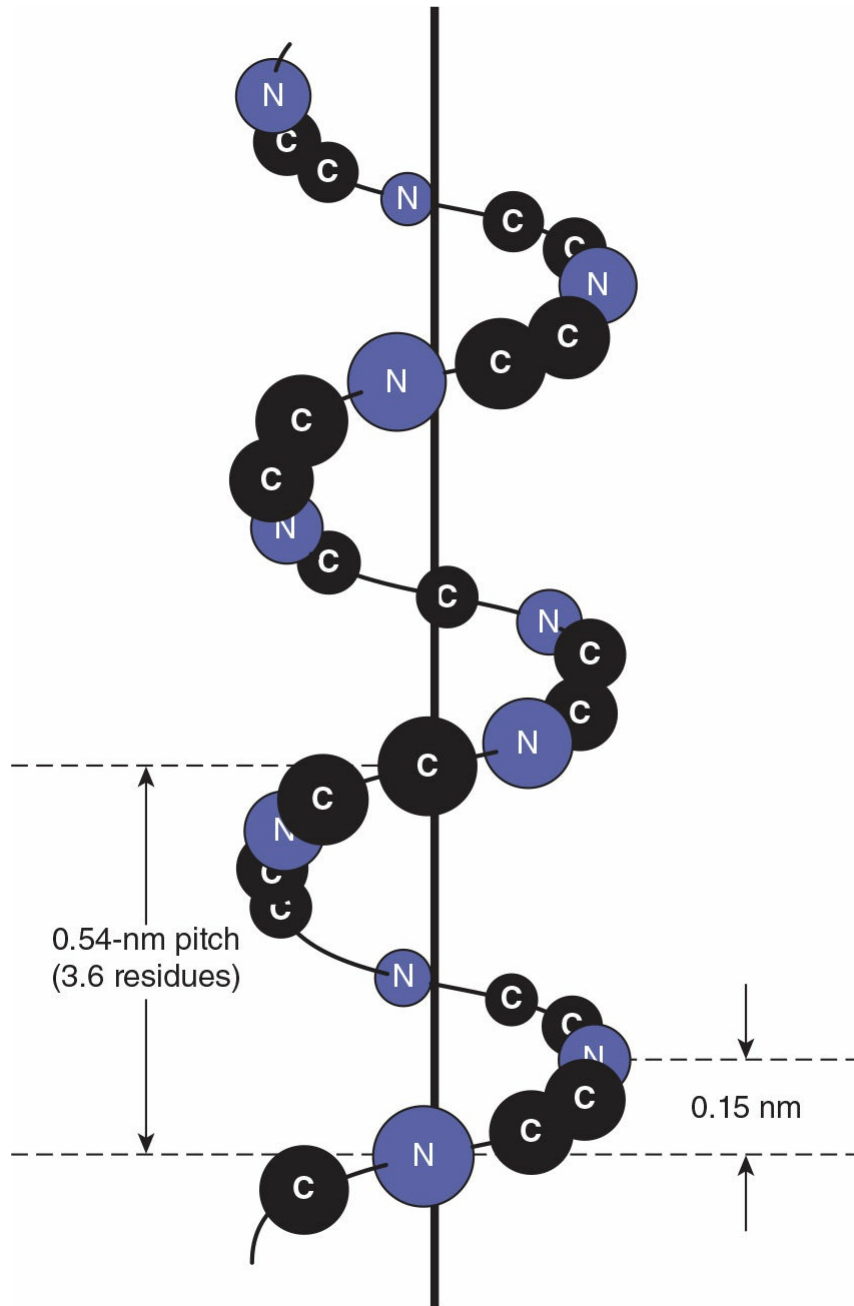

FIGURE 5–2 Orientation of the main chain atoms of a peptide about the axis of an α helix.

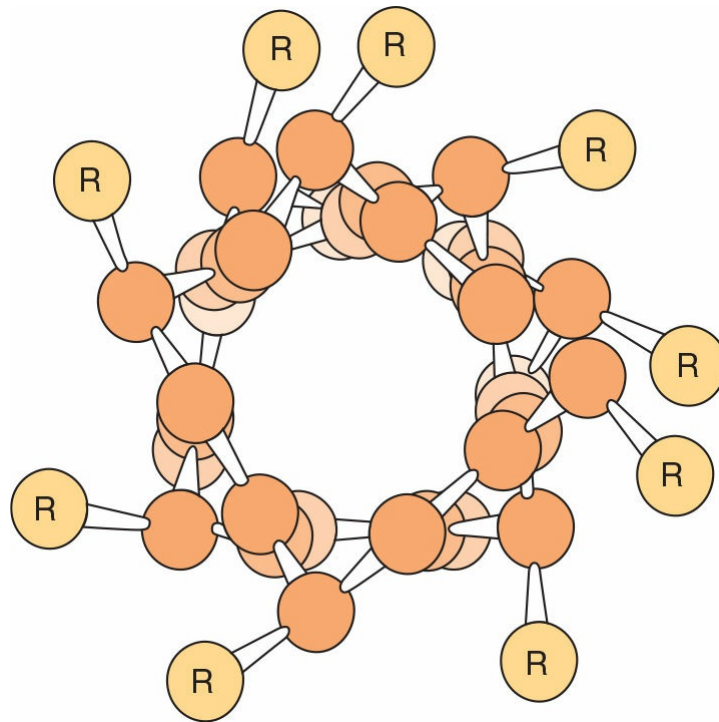

FIGURE 5-3 View down the axis of a polypeptide α helix. The side chains (R) are on the outside of the helix. The van der Waals radii of the atoms are larger than shown here; hence, there is almost no free space inside the helix.

The stability of an α helix arises primarily from hydrogen bonds formed between the oxygen of the peptide bond carbonyl and the hydrogen atom of the peptide bond nitrogen of the fourth residue down the polypeptide chain (**Figure 5-4**). The ability to form the maximum number of hydrogen bonds, supplemented by van der Waals interactions in the core of this tightly packed structure, provides the thermodynamic driving force for the formation of an α helix. Since the peptide bond nitrogen of proline lacks a hydrogen atom, it is incapable of forming a hydrogen bond with a carbonyl oxygen. Consequently, proline can only be stably accommodated within the first turn of an α helix. When present elsewhere, proline disrupts the conformation of the helix, producing a bend. Because it possesses such a small R group, glycine also frequently induces bends within α helices.

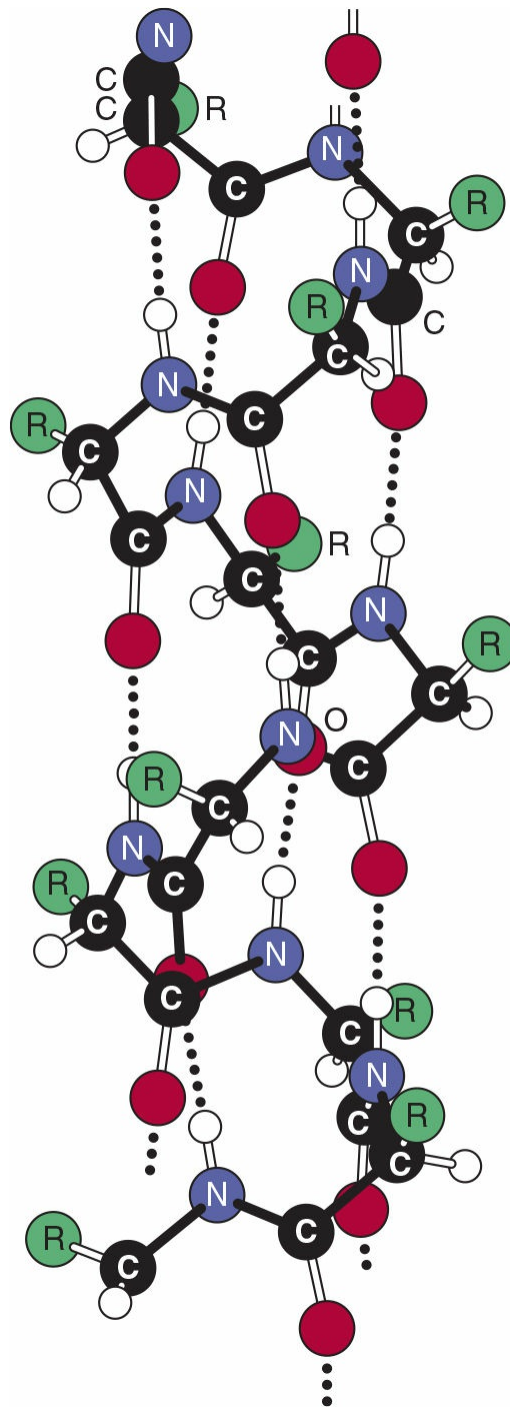

FIGURE 5–4 Hydrogen bonds (dotted lines) formed between H and O atoms stabilize a polypeptide in an α -helical conformation.

Many α helices have predominantly hydrophobic R groups projecting from one side of the axis of the helix and predominantly hydrophilic R groups projecting from the other side. These **amphipathic helices** are well adapted to the formation of interfaces between polar and nonpolar regions such as the hydrophobic interior of a protein and its aqueous environment. Clusters of amphipathic helices can create *channels*, or pores, through

hydrophobic cell membranes that permit specific polar molecules to pass.

Beta Sheet

The second (hence “beta”) recognizable regular secondary structure in proteins is the β sheet. The amino acid residues of a β sheet, when viewed edge-on, form a zigzag or pleated pattern in which the R groups of adjacent residues project in opposite directions. Unlike the compact backbone of the α helix, the peptide backbone of the β sheet is highly extended. However, like the α helix, β sheets derive much of their stability from hydrogen bonds between the carbonyl oxygens and amide hydrogens of peptide bonds. However, in contrast to the α helix, these bonds are formed with adjacent segments of the β sheet (**Figure 5–5**).

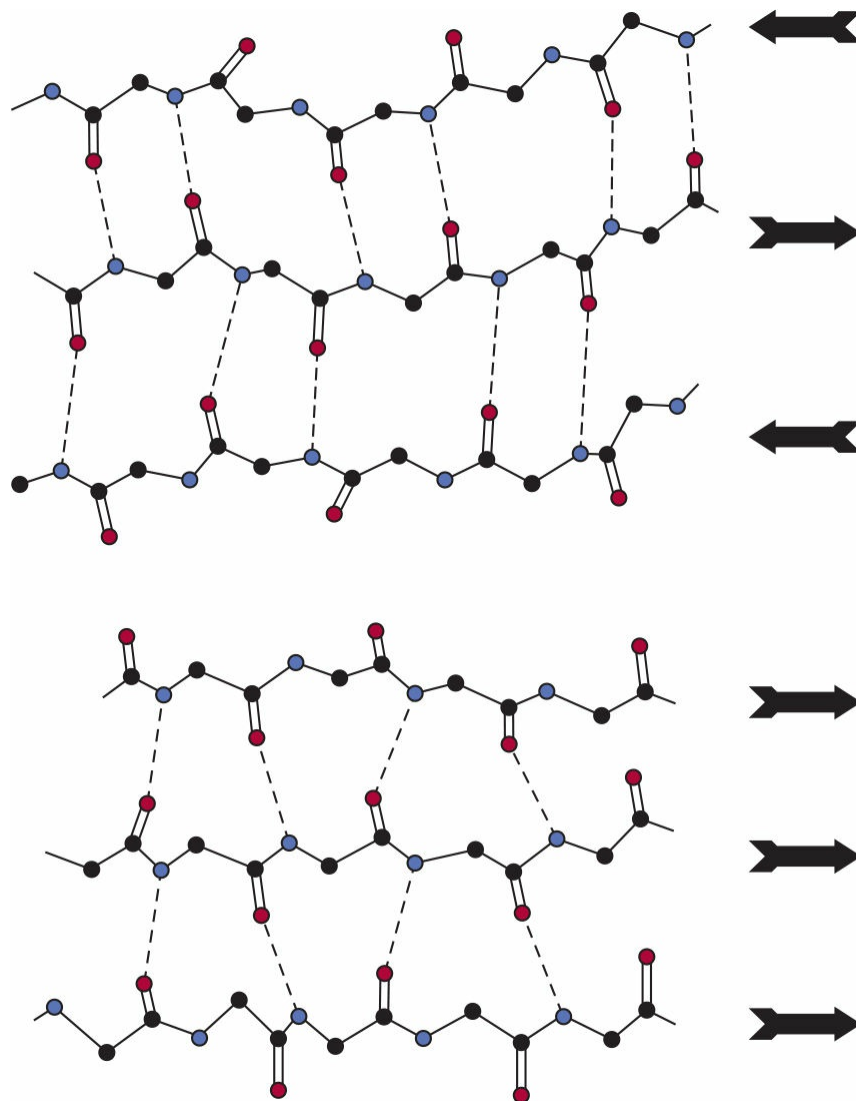

FIGURE 5–5 Spacing and bond angles of the hydrogen bonds of antiparallel and parallel pleated β sheets. Arrows indicate the direction

of each strand. Hydrogen bonds are indicated by dotted lines with the participating α -nitrogen atoms (hydrogen donors) and oxygen atoms (hydrogen acceptors) shown in blue and red, respectively. Backbone carbon atoms are shown in black. For clarity in presentation, R groups and hydrogen atoms are omitted. **Top:** Antiparallel β sheet. Pairs of hydrogen bonds alternate between being close together and wide apart and are oriented approximately perpendicular to the polypeptide backbone. **Bottom:** Parallel β sheet. The hydrogen bonds are evenly spaced but slant in alternate directions.

Interacting β sheets can be arranged either to form a **parallel β sheet**, in which the adjacent segments of the polypeptide chain proceed in the same direction amino to carboxyl, or an **antiparallel sheet**, in which they proceed in opposite directions ([Figure 5-5](#)). Either configuration permits the maximum number of hydrogen bonds between segments, or strands, of the sheet. Most β sheets are not perfectly flat but tend to have a right-handed twist. Clusters of twisted strands of β sheet, sometimes referred to as β barrels, form the core of many globular proteins ([Figure 5-6](#)). Schematic diagrams represent β sheets as arrows that point in the amino to the carboxyl terminal direction.

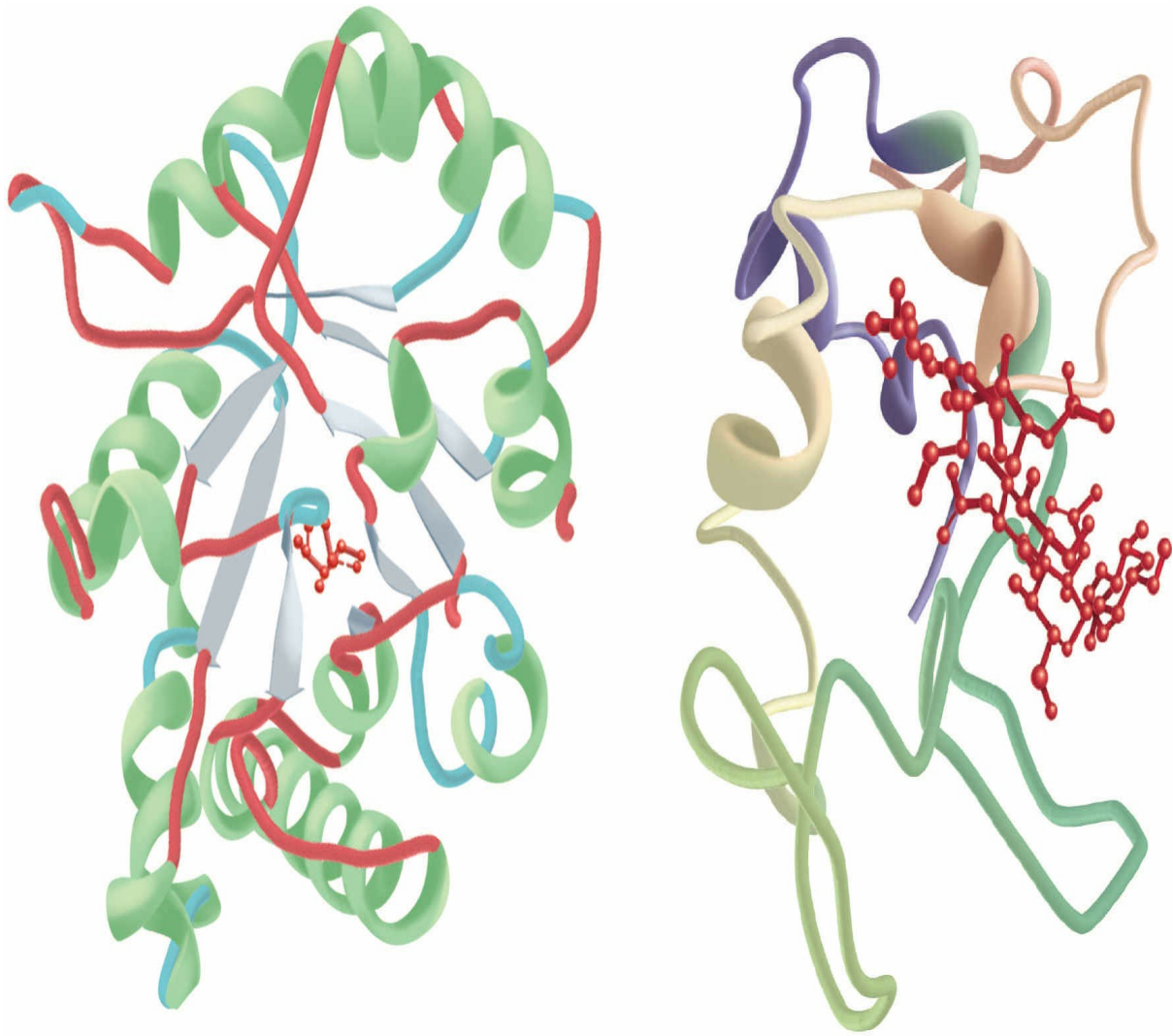

FIGURE 5–6 Examples of the tertiary structure of proteins. **Left:** The enzyme triose phosphate isomerase complexed with the substrate analog 2-phosphoglycerate (red). Note the elegant and symmetrical arrangement of alternating β sheets (gray) and α helices (green), with the β sheets forming a β -barrel core surrounded by the helices. (Adapted from Protein Data Bank ID no. 1o5x.) **Right:** Lysozyme complexed with the substrate analog penta-*N*-acetyl chitopentaose (red). The color of the polypeptide chain is graded along the visible spectrum from purple (N-terminal) to tan (C-terminal). Note, the concave shape of the domain forms a binding pocket for the pentasaccharide, the lack of β sheet, and the high proportion of loops and bends. (Adapted from Protein Data Bank ID no. 1sfb.)

Loops & Bends

Roughly half of the residues in a “typical” globular protein reside in α helices or β sheets, and half in loops, turns, bends, and other extended

conformational features. Turns and bends refer to short segments of amino acids that join two units of the secondary structure, such as two adjacent strands of an antiparallel β sheet. A β turn involves four aminoacyl residues, in which the first residue is hydrogen-bonded to the fourth, resulting in a tight 180° turn (**Figure 5–7**). Proline and glycine often are present in β turns.

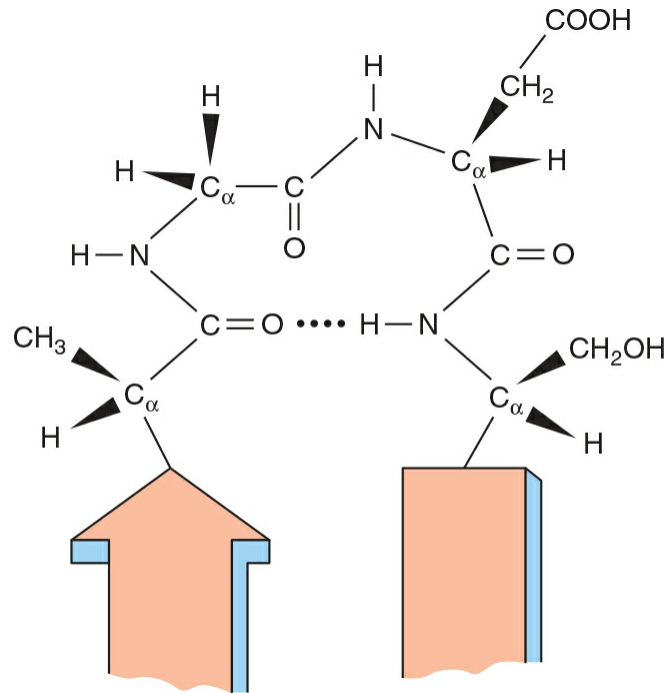

FIGURE 5–7 A β turn that links two segments of antiparallel β sheet. The dotted line indicates the hydrogen bond between the first and fourth amino acids of the four-residue segment Ala-Gly-Asp-Ser.

Loops are regions that contain residues beyond the minimum number necessary to connect adjacent regions of secondary structure. Irregular in conformation, loops nevertheless serve key biologic roles. For many enzymes, the loops that bridge domains responsible for binding substrates often contain aminoacyl residues that participate in catalysis. **Helix-loop-helix motifs** provide the oligonucleotide-binding portion of many DNA-binding proteins such as repressors and transcription factors. Structural motifs such as the helix-loop-helix motif or the E-F hands of calmodulin (see [Chapter 51](#)) that are intermediate in scale between secondary and tertiary structures are often termed **supersecondary structures**. Since many loops and bends reside on the surface of proteins, and are thus exposed to solvent, they constitute readily accessible sites, or **epitopes**, for recognition and binding of antibodies.

While loops lack apparent structural regularity, many adopt a specific conformation stabilized through hydrogen bonding, salt bridges, and hydrophobic interactions with other portions of the protein. However, not all portions of proteins are necessarily ordered. Proteins may contain “disordered” regions, often at the extreme amino or carboxyl terminal, characterized by high conformational flexibility. In many instances, these disordered regions assume an ordered conformation upon binding of a ligand. This structural flexibility enables such regions to act as ligand-controlled switches that affect protein structure and function.

Tertiary & Quaternary Structure

The term “tertiary structure” refers to the entire three-dimensional conformation of a polypeptide. It indicates, in three-dimensional space, how secondary structural features—helices, sheets, bends, turns, and loops—assemble to form domains and how these domains relate spatially to one another. A **domain** is a section of the protein structure sufficient to perform a particular chemical or physical task such as binding of a substrate or other ligand. Most domains are modular in nature, that is, contiguous in both primary sequence and three-dimensional space (**Figure 5–8**). Simple proteins, particularly those that interact with a single substrate or other ligand, such as lysozyme, triose phosphate isomerase (**Figure 5–6**), or the oxygen storage protein myoglobin (see **Chapter 6**), often consist of a single domain. By contrast, lactate dehydrogenase is comprised of two domains, an N-terminal NAD^+ -binding domain and a C-terminal binding domain for the second substrate, pyruvate (**Figure 5–8**). Lactate dehydrogenase is one of the family of oxidoreductases that share a common N-terminal NAD(P)^+ -binding domain known as the **Rossmann fold**. By fusing a segment of DNA coding for a Rossmann fold domain to that coding for a variety of C-terminal domains, a large family of oxidoreductases have evolved that utilize $\text{NAD(P)}^+/\text{NAD(P)H}$ for the oxidation and reduction of a wide range of metabolites. Examples include alcohol dehydrogenase, glyceraldehyde-3-phosphate dehydrogenase, malate dehydrogenase, quinone oxidoreductase, 6-phosphogluconate dehydrogenase, D-glycerate dehydrogenase, and formate dehydrogenase.

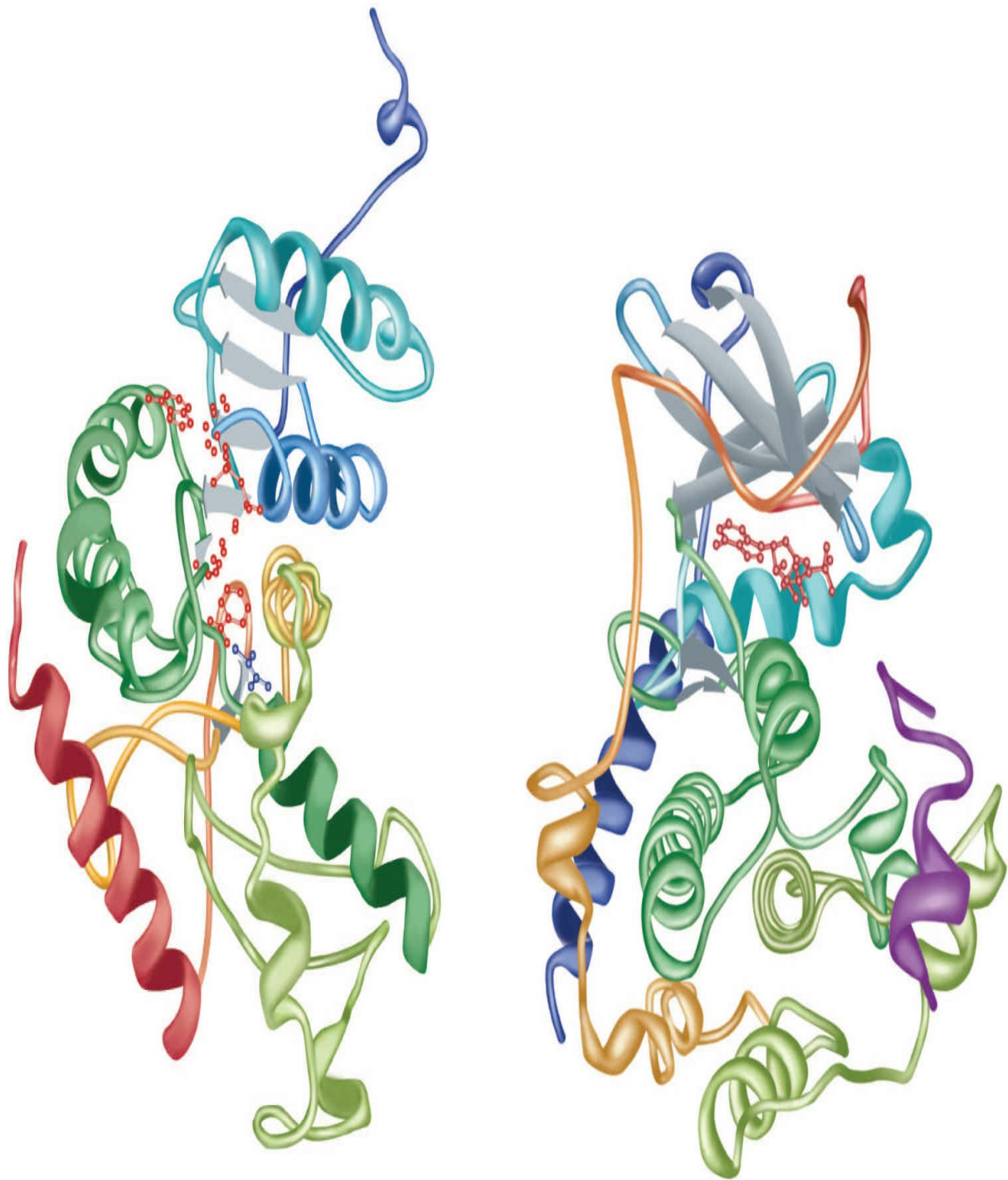

FIGURE 5–8 Polypeptides containing two domains. Left: Shown is the three-dimensional structure of a monomer unit of the tetrameric enzyme lactate dehydrogenase with the substrates NADH (red) and pyruvate (blue) bound. Not all bonds in NADH are shown. The color of the polypeptide chain is graded along the visible spectrum from blue (N-terminal) to orange (C-terminal). Note how the N-terminal portion of the polypeptide forms a contiguous domain, encompassing the upper portion of the enzyme, responsible for binding NADH. Similarly, the C-terminal portion

forms a contiguous domain responsible for binding pyruvate. (Adapted from Protein Data Bank ID no. 3ldh.) **Right:** Shown is the three-dimensional structure of the catalytic subunit of the cAMP-dependent protein kinase (see [Chapter 42](#)) with the substrate analogs ADP (red) and peptide (purple ribbon) bound. The color of the polypeptide chain is graded along the visible spectrum from blue (N-terminal) to orange (C-terminal). Protein kinases transfer the γ -phosphoryl group of ATP to protein and peptide substrates (see [Chapter 9](#)). Note how the N-terminal portion of the polypeptide forms a contiguous domain rich in β sheet that binds ADP. Similarly, the C-terminal portion forms a contiguous, α -helix-rich domain responsible for binding the peptide substrate. (Adapted from Protein Data Bank ID no. 1jbp.)

Not all domains bind substrates. Hydrophobic domains anchor proteins to membranes or enable them to span membranes. Localization sequences target proteins to specific subcellular or extracellular locations such as the nucleus, mitochondria, secretory vesicles, etc. Regulatory domains trigger changes in protein function in response to the binding of allosteric effectors or covalent modifications (see [Chapter 9](#)). Combining the genetic material coding for individual domain modules provides a facile route for generating proteins of great structural complexity and functional sophistication ([Figure 5-9](#)).

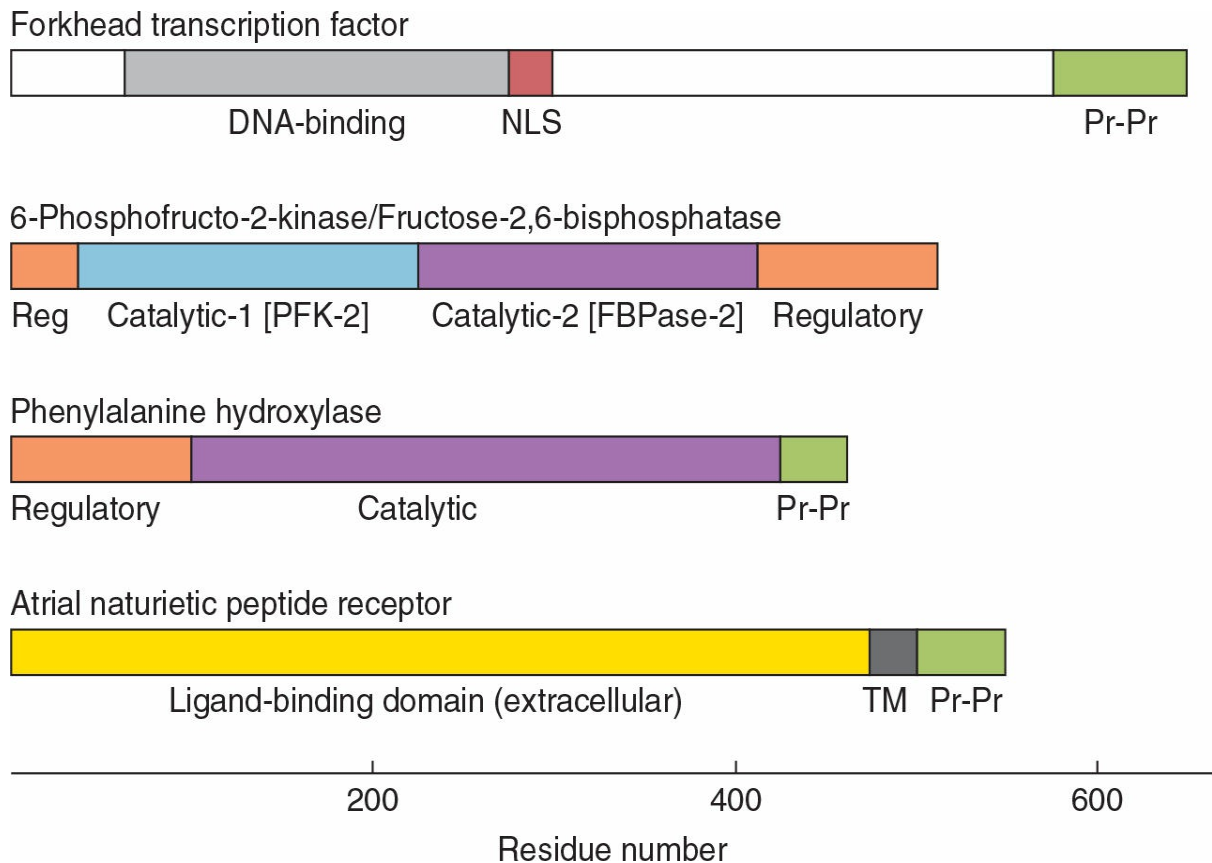

FIGURE 5–9 Some multidomain proteins. The rectangles represent the polypeptide sequences of a forkhead transcription factor; 6-phosphofructo-2-kinase/fructose-2,6-bisphosphatase, a bifunctional enzyme whose activities are controlled in a reciprocal fashion by allosteric effectors and covalent modification (see [Chapter 19](#)); phenylalanine hydroxylase (see [Chapters 27](#) and [29](#)), whose activity is stimulated by phosphorylation of its regulatory domain; and a receptor for atrial natriuretic peptide receptor, whose intracellular domain transmits signals through protein–protein interactions with heterotrimeric GTP-binding proteins (see [Chapter 42](#)). Regulatory domains are colored orange, catalytic domains in blue or purple, protein–protein interaction domains (Pr-Pr) in green, DNA-binding domains in gray, nuclear localization sequences in red, ligand-binding domains in light yellow, and transmembrane domains in black. The kinase and bisphosphatase activities of 6-phosphofructo-2-kinase/fructose-2,6-bisphosphatase are catalyzed by the N- (PFK-2) and C-terminal (FBP2-ase) proximate catalytic domains, respectively.

Proteins containing multiple domains can also be assembled through the association of multiple polypeptides, or protomers. Quaternary structure defines the polypeptide composition of a protein and, for an oligomeric protein, the spatial relationships between its protomers or subunits.

Monomeric proteins consist of a single polypeptide chain. **Dimeric** proteins contain two polypeptide chains. **Homodimers** contain two copies of the same polypeptide chain, while in a **heterodimer** the polypeptides differ. Greek letters (α , β , γ , etc) are used to distinguish different subunits of a hetero-oligomeric protein, and subscripts indicate the number of each subunit type. For example, α_4 designates a homotetrameric protein, and $\alpha_2\beta_2\gamma$, a protein with five subunits of three different types.

Schematic Diagrams Highlight Specific Structural Features

The three-dimensional structure for literally thousands of proteins can be accessed through the Protein Data Bank (<http://www.rcsb.org/pdb/home/home.do>) and other repositories. While one can obtain the images that indicate the position of every atom, since even small proteins contain many thousands of atoms, such depictions are generally too complex to be readily interpreted. Therefore, textbooks, journals, websites, etc oftentimes utilize simplified schematic diagrams designed to highlight specific features of a protein's tertiary and quaternary structure. Ribbon diagrams (Figures 5–6 and 5–8) trace the conformation of the polypeptide backbone, with cylinders and arrows indicating regions of α helix and β sheet, respectively. In an even simpler representation, line segments that link the α -carbons of each amino acid residue indicate the path of the polypeptide backbone. In order to emphasize specific structure–function relationships, these schematic diagrams often depict the side chains of selected amino acids.

MULTIPLE FACTORS STABILIZE TERTIARY & QUATERNARY STRUCTURE

Higher orders of protein structure are stabilized primarily—and often exclusively—by noncovalent interactions. Principal among these are hydrophobic interactions that drive most hydrophobic amino acid side chains into the interior of the protein away from the surrounding water. Other significant contributors include hydrogen bonds and salt bridges between the carboxylates of aspartic and glutamic acid and the oppositely charged side chains of protonated lysyl, arginyl, and histidyl residues. These interactions are individually weak—1 to 5 kcal/mol relative to 80 to 120 kcal/mol for a covalent bond. However, just as a Velcro fastener

harnesses the cumulative strength of a multitude of tiny plastic loops and hooks, collectively these individually weak but numerous interactions confer a high degree of stability upon the biologically functional conformation of a protein.

Some proteins contain covalent disulfide (S—S) bonds that link the sulfhydryl groups of cysteinyl residues. Formation of disulfide bonds involves oxidation of the cysteinyl sulfhydryl groups and requires oxygen. Intrapolypeptide disulfide bonds further enhance the stability of the folded conformation of a peptide, while interpolypeptide disulfide bonds stabilize the quaternary structure of certain oligomeric proteins.

BIOPHYSICAL TECHNIQUES REVEAL THREE-DIMENSIONAL STRUCTURE

X-Ray Crystallography

Following the solution of the three-dimensional structure of myoglobin by John Kendrew in 1960, x-ray crystallography has revealed the structures of thousands of biologic macromolecules ranging from proteins to oligonucleotides and viruses. For the solution of its structure by x-ray crystallography, a protein is first precipitated under conditions that form well-ordered crystals. To establish appropriate conditions, crystallization trials use a few microliters of protein solution and a matrix of variables (temperature, pH, presence of salts or organic solutes such as polyethylene glycol) to establish optimal conditions for crystal formation. Crystals mounted in quartz capillaries are first irradiated with monochromatic x-rays of approximate wavelength 0.15 nm to confirm that they are comprised of protein, not salt. Protein crystals may then be frozen in liquid nitrogen for subsequent collection of a high-resolution data set. Early crystallographers collected the circular patterns formed by the diffracted x-rays on film and analyzed them by hand. Today, the patterns are recorded electronically using an area detector, then analyzed using a mathematical approach termed a *Fourier synthesis*, which summates wave functions. The wave amplitudes are related to spot intensity, but since the waves are not in phase, the relationship between their phases must next be determined in order to extrapolate the positions of the atoms that gave rise to the diffraction pattern.

The traditional approach to solution of the “phase problem” employs **isomorphous displacement**. Prior to irradiation, an atom with a distinctive x-ray “signature,” such as mercury or uranium, is introduced

into a crystal at known positions in the primary structure of the protein. An alternative approach uses the expression of plasmid-encoded recombinant proteins in which selenium replaces the sulfur of methionine. Expression uses a bacterial host auxotrophic for methionine biosynthesis and a defined medium in which selenomethionine replaces methionine. If the unknown structure is similar to one that has already been solved, **molecular replacement** on an existing model provides an attractive way to phase the data without the use of heavy atoms. Finally, the results from the phasing and Fourier summations provide an electron density profile or three-dimensional map of how the atoms are connected or related to one another. The ability of some crystallized enzymes to act as catalysts suggests that their crystal structures faithfully reflect that of the enzyme in free solution.

Nuclear Magnetic Resonance Spectroscopy

Nuclear magnetic resonance (NMR) spectroscopy, a powerful complement to x-ray crystallography, measures the absorbance of radio frequency electromagnetic energy by certain atomic nuclei. “NMR-active” isotopes of biologically relevant elements include ^1H , ^{13}C , ^{15}N , and ^{31}P . The frequency, or chemical shift, at which a particular nucleus absorbs energy is a function of both the functional group within which it resides and the proximity of other NMR-active nuclei. Once limited to metabolites and relatively small macromolecules, today proteins and protein complexes of > 100 kDa can be analyzed by NMR. By measuring the proximity of NMR-active nuclei to one another, two-dimensional NMR spectroscopy permits a three-dimensional representation of a protein to be constructed. Since NMR spectroscopy analyzes proteins in aqueous solution, it obviates the need to form crystals (a particular advantage when dealing with difficult to crystallize membrane proteins) and renders it possible to observe the changes in conformation that accompany ligand binding or catalysis in real time. Since NMR is noninvasive and nondestructive, it also offers the possibility of one day being able to observe the structure and dynamics of proteins (and metabolites) within living cells.

Electron Microscopy

The development of the microscope in the 1600s by **van Leeuwenhoek** triggered a revolution in biology. Scientists were now able to obtain two-dimensional images that revealed the cellular nature of living tissue and the existence of microbial organisms. However, the resolution of

microscopic analyses was limited by the relatively long wavelength of the available sources of electromagnetic radiation, generally visible light ($4\text{--}7 \times 10^{-7}$ m). By coating materials spread in a monolayer with uranyl acetate or some other heavy metal-containing compound, **electron microscopy** (EM) can employ high-energy electrons with wavelengths of $1\text{--}10 \times 10^{-12}$ m to generate two-dimensional projection images at a resolution of a few Angstroms.

Cryo–Electron Microscopy

Biochemists have long dreamed of directly viewing proteins and other biological macromolecules in the same manner that microbiologists and cell biologists can directly view living cells. However, the resolution of optical microscopes was inherently limited by the wavelength of light. In the mid-20th century, scientists developed electron microscopes which use beams of electrons as their source of electromagnetic radiation. The lower wavelength of their electron beams enabled electron microscopes to magnify objects more than a million times more than using an optical microscope—sufficient to visualize large macromolecules such as ribosomes and DNA plasmids. However, the high energy of the electron beam and the need to work under high vacuum conditions were incompatible with the survival of organic molecules.

In 2017, Jacques Dubochet, Joachim Frank, and Richard Henderson were awarded a Nobel Prize for the development of cryo electron microscopy (cryo-EM). Cryo-EM employs ultracold media such as liquid nitrogen (T around -195°C), liquid ethane, or liquid helium to stabilize biomolecules in a *hydrated* state and protect them from heating when bombarded by the electron beam. This technique allows large macromolecules and macromolecular complexes to be visualized. The extremely low temperatures conferred the added benefit of stabilizing these macromolecules in a particular *conformational state*, thus revealing different structural conformations. Tomography generates three-dimensional images of biomacromolecular complexes in a given conformational state by using computer algorithms to generate a composite using the two-dimensional images of complexes captured in several different orientations on the EM sample grid. The effect of factors that trigger changes in conformational state can thus be determined and compared. The front cover of this book illustrates one example of cryo-EM, a 5 Å depiction of the proteins of the Zika virus.

Molecular Modeling

A valuable adjunct to the empirical determination of the three-dimensional structure of proteins is the use of computer technology for molecular modeling. When the three-dimensional structure is known, **molecular dynamics** programs can be used to simulate the conformational dynamics of a protein and the manner in which factors such as temperature, pH, ionic strength, or amino acid substitutions influence these motions.

Molecular docking programs simulate the interactions that take place when a protein encounters a substrate, inhibitor, or other ligand. Virtual screening for molecules likely to interact with key sites on a protein of biomedical interest is extensively used to facilitate the discovery of new drugs.

Molecular modeling is also employed to infer the structure of proteins for which x-ray crystallographic or NMR structures are not yet available. Secondary structure algorithms weigh the propensity of specific residues to become incorporated into α helices or β sheets in previously studied proteins to predict the secondary structure of other polypeptides. In **homology modeling**, the known three-dimensional structure of a protein is used as a template upon which to erect a model of the *probable* structure of a related protein. Scientists are working to devise computer programs that will reliably predict the three-dimensional conformation of a protein directly from its primary sequence, thereby permitting determination of the structures of the many unknown proteins for which templates currently are lacking.

PROTEIN FOLDING

Proteins are conformationally dynamic molecules that can fold into their functionally competent conformation in a time frame of milliseconds. Moreover, they often can refold if their conformation becomes disrupted, a process called renaturation. How are the remarkable speed and fidelity of protein folding attained? In nature, folding into the native state occurs too rapidly to be the product of a random, haphazard search of all possible structures. Denatured proteins are not just random coils. Native contacts are favored, and regions of the native structure persist even in the denatured state. Discussed below are factors that facilitate and are basic mechanistic features of protein folding–refolding.

Native Conformation of a Protein Is

Thermodynamically Favored

The number of distinct combinations of phi and psi angles specifying potential conformations of even a relatively small—15 kDa—polypeptide is unbelievably vast. Proteins are guided through this vast labyrinth of possibilities by thermodynamics. Since the biologically relevant—or native—conformation of a protein generally is the one that is most energetically favored, knowledge of the native conformation is specified in the primary sequence. However, if one were to wait for a polypeptide to find its native conformation by random exploration of all possible conformations, the process would require billions of years to complete. Clearly, in nature, protein folding takes place in a more orderly and guided fashion.

Folding Is Modular

Protein folding generally occurs via a stepwise process. In the first stage, as the newly synthesized polypeptide emerges from the ribosome, short segments fold into secondary structural units that provide local regions of organized structure. Folding is now reduced to the selection of an appropriate arrangement of this relatively small number of secondary structural elements (analogous to the manner in which the classic “animal, mineral, or vegetable” query typically is used to start a round of the parlor game “20 questions”). In the second stage, the hydrophobic regions segregate into the interior of the protein away from solvent, forming a “molten globule,” a partially folded polypeptide in which the secondary structure modules rearrange until the mature conformation of the protein is attained. This process is orderly, but not rigid. Considerable flexibility exists in the ways and in the order in which elements of secondary structure can be rearranged. In general, each element of the secondary or supersecondary structure facilitates proper folding by directing the folding process toward the native conformation and away from unproductive alternatives. For oligomeric proteins, individual protomers tend to fold before they associate with other subunits.

Auxiliary Proteins Assist Folding

Under appropriate laboratory conditions, many proteins will spontaneously refold after being **denatured** (ie, unfolded) by treatment with acid or base, chaotropic agents, or detergents. However, refolding under these conditions is slow—minutes to hours. Moreover, most proteins fail to

spontaneously refold in vitro. Instead they form insoluble **aggregates**, disordered complexes of unfolded or partially folded polypeptides held together predominantly by hydrophobic interactions. Aggregates represent unproductive dead ends in the folding process. Cells employ auxiliary proteins to speed the process of folding and to guide it toward a productive conclusion.

Chaperones

Chaperone proteins participate in the folding of over half of all mammalian proteins. The hsp70 (70-kDa heat shock protein) family of chaperones binds short sequences of hydrophobic amino acids that emerge while a new polypeptide is being synthesized, shielding them from solvent. Chaperones prevent aggregation, thus providing an opportunity for the formation of appropriate secondary structural elements and their subsequent coalescence into a molten globule. The hsp60 family of chaperones, sometimes called chaperonins, differs in sequence and structure from hsp70 and its homologs. Hsp60 acts later in the folding process, often together with an hsp70 chaperone. The central cavity of the donut-shaped hsp60 chaperone provides a sheltered nonpolar environment in which a polypeptide can fold until all hydrophobic regions are buried in its interior, thus preempting any tendency toward aggregation.

Protein Disulfide Isomerase

Disulfide bonds between and within polypeptides stabilize tertiary and quaternary structures. The process is initiated by the enzyme protein sulfhydryl oxidase, which catalyzes the oxidation of cysteine residues to form disulfide bonds. However, disulfide bond formation is nonspecific—a given cysteine can form a disulfide bond with any accessible cysteinyl residue. By catalyzing disulfide exchange, the rupture of an S—S bond and its reformation with a different partner cysteine, protein disulfide isomerase facilitates the formation of disulfide bonds that stabilize a protein's native conformation. Since many eukaryotic sulfhydryl oxidases are flavin-dependent, dietary riboflavin deficiency often is accompanied by an increased incidence of improper folding of disulfide-containing proteins.

Proline-*cis*, *trans*-Isomerization

All X-Pro peptide bonds—where X represents any residue—are

synthesized in the *trans* configuration. However, of the X-Pro bonds of mature proteins, approximately 6% are *cis*. The *cis* configuration is particularly common in β turns. Isomerization from *trans* to *cis* is catalyzed by proline-*cis*, *trans*-isomerases, a family of enzymes also known as cyclophilins (**Figure 5–10**). In addition to promoting the maturation of native proteins, cyclophilins also participate in the folding of proteins expressed by viral invaders. Consequently, cyclophilins are being pursued as targets for the development of drugs such as cyclosporine and Alisporivir for the treatment of HIV, hepatitis C, and other virally transmitted diseases.

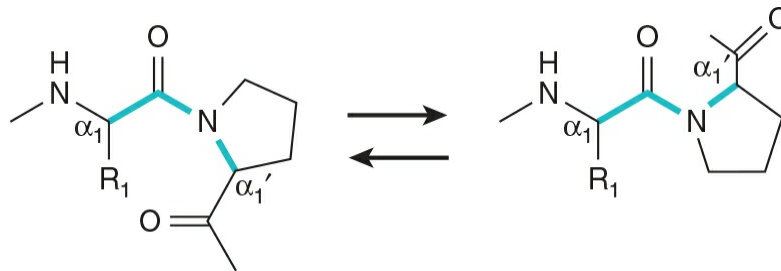

FIGURE 5–10 Isomerization of the N- α_1 prolyl peptide bond from a *cis* to a *trans* configuration relative to the backbone of the polypeptide.

PERTURBATION OF PROTEIN CONFORMATION MAY HAVE PATHOLOGIC CONSEQUENCES

Prions

The transmissible spongiform encephalopathies, or **prion diseases**, are fatal neurodegenerative diseases characterized by spongiform changes, astrocytic gliomas, and neuronal loss resulting from the deposition of insoluble protein aggregates in neural cells. They include Creutzfeldt-Jacob disease in humans, scrapie in sheep, and bovine spongiform encephalopathy (mad cow disease) in cattle. A variant form of Creutzfeldt-Jacob disease (vCJD) that afflicts younger patients is associated with early-onset psychiatric and behavioral disorders. Prion diseases may manifest themselves as infectious, genetic, or sporadic disorders. Because no viral or bacterial gene encoding the pathologic prion protein could be identified, the source and mechanism of transmission of prion disease long remained elusive.

Today it is recognized that **prion diseases are protein conformation**

diseases transmitted by altering the conformation, and hence the physical properties, of proteins endogenous to the host. Human prion-related protein (PrP), a glycoprotein encoded on the short arm of chromosome 20, normally is monomeric and rich in α helix. Pathologic prion proteins serve as the templates for the conformational transformation of normal PrP, known as PrP^c, into PrP^{sc}. PrP^{sc} is rich in β sheet with many hydrophobic aminoacyl side chains exposed to solvent. As each new PrP^{sc} molecule is formed, it triggers the production of yet more pathologic variants in a conformational chain reaction. Because PrP^{sc} molecules associate strongly with one another through their exposed hydrophobic regions, the accumulating PrP^{sc} units coalesce to form insoluble protease-resistant aggregates. Since one pathologic prion or prion-related protein can serve as template for the conformational transformation of many times its number of PrP^c molecules, prion diseases can be transmitted by the protein alone without involvement of DNA or RNA.

Alzheimer Disease

Refolding or misfolding of another protein endogenous to human brain tissue, β -amyloid, is a prominent feature of the Alzheimer disease. While the main cause of the Alzheimer disease remains elusive, the characteristic senile plaques and neurofibrillary bundles contain aggregates of the protein β -amyloid, a 4.3-kDa polypeptide produced by proteolytic cleavage of a larger protein known as amyloid precursor protein. In Alzheimer disease patients, levels of β -amyloid become elevated, and this protein undergoes a conformational transformation from a soluble α helix-rich state to a state rich in β sheet and prone to self-aggregation. Apolipoprotein E has been implicated as a potential mediator of this conformational transformation.

Beta-Thalassemias

Thalassemias are caused by genetic defects that impair the synthesis of one of the polypeptide subunits of hemoglobin (see [Chapter 6](#)). During the burst of hemoglobin synthesis that occurs during erythrocyte development, a specific chaperone called α -hemoglobin-stabilizing protein (AHSP) binds to free hemoglobin α -subunits awaiting incorporation into the hemoglobin multimer. In the absence of this chaperone, free α -hemoglobin subunits aggregate, and the resulting precipitate has cytotoxic effects on the developing erythrocyte. Investigations using genetically modified mice suggest a role for AHSP in modulating the severity of β -thalassemia in

human subjects.

COLLAGEN ILLUSTRATES THE ROLE OF POSTTRANSLATIONAL PROCESSING IN PROTEIN MATURATION

Protein Maturation Often Involves Making & Breaking of Covalent Bonds

The maturation of proteins into their final structural state often involves the cleavage or formation (or both) of covalent bonds, a process of **posttranslational modification**. Many polypeptides are initially synthesized as larger precursors called **proproteins**. The “extra” polypeptide segments in these proproteins often serve as leader sequences that target a polypeptide to a particular organelle or facilitate its passage through a membrane. Other segments ensure that the potentially harmful activity of a protein such as the proteases trypsin and chymotrypsin remains inhibited until these proteins reach their final destination. However, once these transient requirements are fulfilled, the now superfluous peptide regions are removed by selective proteolysis. Other covalent modifications may add new chemical functionalities to a protein. The maturation of collagen illustrates both of these processes.

Collagen Is a Fibrous Protein

Collagen is the most abundant of the fibrous proteins that constitute more than 25% of the protein mass in the human body. Other prominent fibrous proteins include keratin and myosin. These fibrous proteins represent a primary source of structural strength for cells (ie, the cytoskeleton) and tissues. Skin derives its strength and flexibility from an intertwined mesh of collagen and keratin fibers, while bones and teeth are buttressed by an underlying network of collagen fibers analogous to steel strands in reinforced concrete. Collagen also is present in connective tissues such as ligaments and tendons. The high degree of tensile strength required to fulfill these structural roles requires elongated proteins characterized by repetitive amino acid sequences and a regular secondary structure.

Collagen Forms a Unique Triple Helix

Tropocollagen, the repeating unit of a mature collagen fiber, consists of

three collagen polypeptides, each containing about 1000 amino acids, bundled together in a unique conformation, the collagen triple helix (**Figure 5–11**). A mature collagen fiber forms an elongated rod with an axial ratio of about 200. Three intertwined polypeptide strands, which twist to the left, wrap around one another in a right-handed fashion to form the collagen triple helix. The opposing handedness of this superhelix and its component polypeptides makes the collagen triple helix highly resistant to unwinding—a principle also applied to the steel cables of suspension bridges. A collagen triple helix has 3.3 residues per turn and a rise per residue nearly twice that of an α helix. The R groups of each polypeptide strand of the triple helix pack so closely that, in order to fit, one of the three must be H. Thus, every third amino acid residue in collagen is a glycine residue. Staggering of the three strands provides appropriate positioning of the requisite glycines throughout the helix. Collagen is also rich in proline and hydroxyproline, yielding a repetitive Gly-X-Y pattern (**Figure 5–11**) in which Y generally is proline or hydroxyproline.

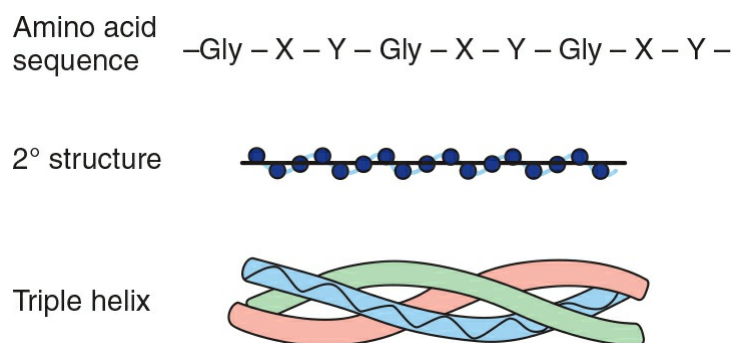

FIGURE 5–11 Primary, secondary, and tertiary structures of collagen.

Collagen triple helices are stabilized by hydrogen bonds between residues in *different* polypeptide chains, a process helped by the hydroxyl groups of hydroxyprolyl residues. Additional stability is provided by covalent cross-links formed between modified lysyl residues both within and between polypeptide chains.

Collagen Is Synthesized as a Larger Precursor

Collagen is initially synthesized as a larger precursor polypeptide, procollagen. Numerous prolyl and lysyl residues of procollagen are hydroxylated by prolyl hydroxylase and lysyl hydroxylase, enzymes that require ascorbic acid (vitamin C; see **Chapters 27** and **44**). Hydroxyprolyl

and hydroxylysyl residues provide additional hydrogen-bonding capability that stabilizes the mature protein. In addition, glucosyl and galactosyl transferases attach glucosyl or galactosyl residues to the hydroxyl groups of specific hydroxylysyl residues.

The central portion of the precursor polypeptide then associates with other molecules to form the characteristic triple helix. This process is accompanied by the removal of the globular amino terminal and carboxyl terminal extensions of the precursor polypeptide by selective proteolysis. Certain lysyl residues are modified by lysyl oxidase, a copper-containing protein that converts ϵ -amino groups to aldehydes. The aldehydes can either undergo an aldol condensation to form a C=C double bond or to form a Schiff base (eneimine) with the ϵ -amino group of an unmodified lysyl residue, which is subsequently reduced to form a C-N single bond. These covalent bonds cross-link the individual polypeptides and imbue the fiber with exceptional strength and rigidity.

Nutritional & Genetic Disorders Can Impair Collagen Maturation

The complex series of events in collagen maturation provide a model that illustrates the biologic consequences of incomplete polypeptide maturation. The best-known defect in collagen biosynthesis is **scurvy**, a result of a dietary deficiency of vitamin C required by prolyl and lysyl hydroxylases. The resulting deficit in the number of hydroxyproline and hydroxylysine residues undermines the conformational stability of collagen fibers, leading to bleeding gums, swelling joints, poor wound healing, and ultimately death. **Menkes syndrome**, characterized by kinky hair and growth retardation, reflects a dietary deficiency of the copper required by lysyl oxidase, which catalyzes a key step in the formation of the covalent cross-links that strengthen collagen fibers.

Genetic disorders of collagen biosynthesis include several forms of osteogenesis imperfecta, characterized by fragile bones. In the Ehlers-Danlos syndrome, a group of connective tissue disorders that involve impaired integrity of supporting structures, defects in the genes that encode α collagen-1, procollagen *N*-peptidase, or lysyl hydroxylase result in mobile joints and skin abnormalities (see [Chapter 50](#)).

SUMMARY

- Proteins may be classified based on their solubility, shape, or function

or on the presence of a prosthetic group, such as heme.

- The gene-encoded primary structure of a polypeptide is the sequence of its amino acids. Its secondary structure results from folding of polypeptides into hydrogen-bonded motifs such as the α helix, the β -pleated sheet, β bends, and loops. Combinations of these motifs can form supersecondary motifs.
- Tertiary structure concerns the relationships between secondary structural domains. Quaternary structure of proteins with two or more polypeptides (oligomeric proteins) concerns the spatial relationships between various types of polypeptides.
- Primary structures are stabilized by covalent peptide bonds. Higher orders of structure are stabilized by weak forces—multiple hydrogen bonds, salt (electrostatic) bonds, and association of hydrophobic R groups.
- The phi (ϕ) angle of a polypeptide is the angle about the C_{α} —N bond; the psi (ψ) angle is that about the C_{α} — C_o bond. Most combinations of phi–psi angles are disallowed due to steric hindrance. The phi–psi angles that form the α helix and the β sheet fall within the lower and upper left-hand quadrants of a Ramachandran plot, respectively.
- Protein folding is a poorly understood process. Broadly speaking, short segments of newly synthesized polypeptide fold into secondary structural units. Forces that bury hydrophobic regions from solvent then drive the partially folded polypeptide into a “molten globule” in which the modules of the secondary structure are rearranged to give the native conformation of the protein.
- Proteins that assist folding include protein disulfide isomerase, proline-*cis*, *trans*-isomerase, and the chaperones that participate in the folding of over half of mammalian proteins. Chaperones shield newly synthesized polypeptides from solvent and provide an environment for elements of secondary structure to emerge and coalesce into molten globules.
- Biomedical researchers are currently working to develop agents that interfere with the folding of viral proteins and prions as drugs for the treatment of hepatitis C and a range of neurodegenerative disorders.
- X-ray crystallography and NMR are key techniques used to study higher orders of protein structure.
- While lacking the atomic-level resolution of x-ray crystallography or NMR, cryo-EM has emerged as a powerful tool for analyzing the macromolecular dynamics of biologic macromolecules in

heterogeneous samples.

- Prions—protein particles that lack nucleic acid—cause fatal transmissible spongiform encephalopathies such as Creutzfeldt-Jakob disease, scrapie, and bovine spongiform encephalopathy. Prion diseases involve an altered secondary–tertiary structure of a naturally occurring protein, PrPc. When PrPc interacts with its pathologic isoform PrPsc, its conformation is transformed from a predominantly α -helical structure to the β -sheet structure characteristic of PrPsc.
- Collagen illustrates the close linkage between protein structure and biologic function. Diseases of collagen maturation include Ehlers-Danlos syndrome and the vitamin C deficiency disease scurvy.

REFERENCES

- Doyle SM, Genest O, Wickner S: Protein rescue from aggregates by powerful molecular chaperone machines. *Nat Rev Mol Cell Biol* 2013;10:617.
- Frausto SD, Lee E, Tang H: Cyclophilins as modulators of viral replication. *Viruses* 2013;5:1684.
- Gianni S, Jemth P: Protein folding: vexing debates on a fundamental problem. *Biophys Chem* 2016;212:17.
- Hartl FU, Hayer-Hartl M: Converging concepts of protein folding in vitro and in vivo. *Nat Struct Biol* 2009;16:574.
- Jucker M, Walker LC: Self-propagation of pathogenic protein aggregates in neurodegenerative diseases. *Nature* 2013;501:45.
- Kim YE, Hipp MS, Bracher A, et al: Molecular chaperone functions in protein folding and proteostasis. *Annu Rev Biochem* 2013;82:323.
- Lee J, Kim SY, Hwang KJ, et al: Prion diseases as transmissible zoonotic diseases. *Osong Public Health Res Perspect* 2013;4:57.
- Narayan M: Disulfide bonds: protein folding and subcellular protein trafficking. *FEBS J* 2013;279:2272.
- Rider MH, Bertrand L, Vertommen D, et al: 6-Phosphofructo-2-kinase/fructose-2,6-bisphosphatase: head-to-head with a bifunctional enzyme that controls glycolysis. *Biochem J* 2004;381:561.
- Shoulders MD, Raines RT: Collagen structure and stability. *Annu Rev Biochem* 2009;78:929.
- White HE, Ignatiou A, Clare DK, et al: Structural study of heterogeneous biological samples by cryoelectron microscopy and image processing. *Biomed Res Int* 2017;2017:1032432.

Exam Questions

Section I – Proteins: Structure & Function

1. Select the one of the following statements that is NOT CORRECT.
 - A. Fermentation and glycolysis share many common biochemical features.
 - B. Louis Pasteur first discovered that cell-free yeast preparations could convert sugars to ethanol and carbon dioxide.
 - C. Organic orthophosphate (P_i) is essential for glycolysis.
 - D. ^{14}C is an important tool for detecting metabolic intermediates.
 - E. Medicine and biochemistry provide mutual insights to one another.
2. Select the one of the following statements that is NOT CORRECT.
 - A. The vitamin derivative NAD is essential for conversion of glucose to pyruvate.
 - B. The term “Inborn errors of metabolism” was coined by the physician Archibald Garrod.
 - C. Mammalian tissue slices can incorporate inorganic ammonia into urea.
 - D. Realization that DNA is a double helix permitted Watson & Crick to describe the polymerase chain reaction (PCR).
 - E. Mutation of the genome of a “model organisms” can provide insight into biochemical processes.
3. Explain how the Büchner’s observation in the early part of the 20th century led to the discovery of the details of fermentation.
4. Name some of the earliest discoveries that followed the realization that a cell-free preparation of yeast cells could catalyze the process of fermentation.
5. Name some of the kinds of tissue preparations that early 20th century biochemists employed to study glycolysis and urea biosynthesis, and to discover the roles of vitamin derivatives.

6. Describe how the availability of radioactive isotopes facilitated the identification of metabolic intermediates.
7. Name several of the “inborn errors of metabolism” identified by the physician Archibald Garrod.
8. Cite an example in lipid metabolism for which the linking of biochemical and genetic approaches has contributed to the advance of medicine and biochemistry.
9. Name several of the intact “model organisms” whose genomes can be selectively altered to provide insight into biochemical processes.
10. Select the one of the following statements that is NOT CORRECT.
The propensity of water molecules to form hydrogen bonds with one another is the primary factor responsible for all of the following properties of water EXCEPT:
 - A. Its atypically high boiling point.
 - B. Its high heat of vaporization.
 - C. Its high surface tension.
 - D. Its ability to dissolve hydrocarbons.
 - E. Its expansion upon freezing.
11. Select the one of the following statements that is NOT CORRECT.
 - A. The side-chains of the amino acids cysteine and methionine absorb light at 280 nm.
 - B. Glycine is often present in regions where a polypeptide forms a sharp bend, reversing the direction of a polypeptide.
 - C. Polypeptides are named as derivatives of the C-terminal aminoacyl residue.
 - D. The C, N, O, and H atoms of a peptide bond are coplanar.
 - E. A linear pentapeptide contains four peptide bonds.
12. Select the one of the following statements that is NOT CORRECT.
 - A. Buffers of human tissue include bicarbonate, proteins, and orthophosphate.
 - B. A weak acid or a weak base exhibits its greatest buffering capacity when the pH is equal to its pK_a plus or minus one pH unit.

- C. The isoelectric pH (pI) of lysine can be calculated using the formula $(pK_2 + pK_3)/2$.
- D. The mobility of a monofunctional weak acid in a direct current electrical field reaches its maximum when the pH of its surrounding environment is equal to its pK_a .
- E. For simplicity, the strengths of weak bases are generally expressed as the pK_a of their conjugate acids.
13. Select the one of the following statements that is NOT CORRECT.
- A. If the pK_a of a weak acid is 4.0, 50% of the molecules will be in the dissociated state when the pH of the surrounding environment is 4.0.
- B. A weak acid with a pK_a of 4.0 will be a more effective buffer at pH 3.8 than at pH 5.7.
- C. At a pH equal to its pI, a polypeptide carries no charged groups.
- D. Strong acids and bases are so named because they undergo complete dissociation when dissolved in water.
- E. The pK_a of an ionizable group can be influenced by the physical and chemical properties of its surrounding environment.
14. Select the one of the following statements that is NOT CORRECT.
- A. A major objective of proteomics is to identify all of the proteins present in a cell under different conditions as well as their states of modification.
- B. Mass spectrometry has largely replaced the Edman method for sequencing of peptides and proteins.
- C. Sanger reagent was an improvement on Edman's because the former generates a new amino terminus, allowing several consecutive cycles of sequencing to take place.
- D. Since mass is a universal property of all atoms and molecules, mass spectrometry is ideally suited to the detection of posttranslational modifications in proteins.
- E. Time-of-flight mass spectrometers take advantage of the relationship $F = ma$.
15. Why does olive oil added to water tend to form large droplets?

16. What distinguishes a strong base from a weak base?
17. Select the one of the following statements that is NOT CORRECT.
- A. Ion-exchange chromatography separates proteins based upon the sign and magnitude of their charge at a given pH.
 - B. Two-dimensional gel electrophoresis separates proteins first on the basis of their pI values and second on their charge-to-mass ratio using SDS-PAGE.
 - C. Affinity chromatography exploits the selectivity of protein-ligand interactions to isolate a specific protein from a complex mixture.
 - D. Many recombinant proteins are expressed with an additional domain fused to their N- or C-terminus. One common component of these fusion domains is a ligand-binding site designed expressly to facilitate purification by affinity chromatography.
 - E. Following purification by classical techniques, tandem mass spectrometry typically is used to analyze individual homogeneous peptides derived from a complex protein mixture.
18. Select the one of the following statements that is NOT CORRECT.
- A. Protein folding is assisted by intervention of specialized auxiliary proteins called chaperones.
 - B. Protein folding tends to be modular, with areas of local secondary structure forming first, then coalescing into a molten globule.
 - C. Protein folding is driven first and foremost by the thermodynamics of the water molecules surrounding the nascent polypeptide.
 - D. The formation of S-S bonds in a mature protein is facilitated by the enzyme protein disulfide isomerase.
 - E. Only a few unusual proteins, such as collagen, require posttranslational processing by partial proteolysis to attain their mature conformation.
19. Estimate pI for a polyelectrolyte that contains three carboxyl groups and three amino groups whose pK_a values are 4.0, 4.6, 6.3, 7.7, 8.9, and 10.2.
20. State one drawback of the categorization of the protein amino acids simply as “essential” or “nonessential”?
21. Select the one of the following statements that is NOT CORRECT.

- A. Posttranslational modifications of proteins can affect both their function and their metabolic fate.
 - B. The native conformational state generally is that which is thermodynamically favored.
 - C. The complex three-dimensional structures of most proteins are formed and stabilized by the cumulative effects of a large number of weak interactions.
 - D. Research scientists employ gene arrays for the high-throughput detection of the presence and expression level of proteins.
 - E. Examples of weak interactions that stabilize protein folding include hydrogen bonds, salt bridges, and van der Waals forces.
22. Select the one of the following statements that is NOT CORRECT.
- A. Changes in configuration involve the rupture of covalent bonds.
 - B. Changes in conformation involve the rotation of one or more single bonds.
 - C. The Ramachandran plot illustrates the degree to which steric hindrance limits the permissible angles of the single bonds in the backbone of a peptide or protein.
 - D. Formation of an α helix is stabilized by the hydrogen bonds between each peptide bond carboxyl oxygen and the N-H group of the next peptide bond.
 - E. In a β sheet the R groups of adjacent residues point in opposite directions relative to the plane of the sheet.
23. Select the one of the following statements that is NOT CORRECT.
- A. The descriptor $\alpha_2\beta_2\gamma_3$ denotes a protein with seven subunits of three different types.
 - B. Loops are extended regions that connect adjacent regions of secondary structure.
 - C. More than half of the residues in a typical protein reside in either α helices or β sheets.
 - D. Most β sheets have a right-handed twist.
 - E. Prions are viruses that cause protein-folding diseases that attack the brain.
24. What advantage does the acidic group of phosphoric acid that is associated with pK_2 offer for buffering in human tissues?

25. The dissociation constants for a previously uncharacterized racemic amino acid discovered in a meteor have been determined to be $pK_1 = 2.0$, $pK_2 = 3.5$, $pK_3 = 6.3$, $pK_4 = 8.0$, $pK_5 = 9.8$, and $pK_7 = 10.9$:
- A. What carboxyl or amino functional group would you expect to be associated with each dissociation?
 - B. What would be the approximate net charge on this amino acid at pH 2?
 - C. What would be its approximate net charge at pH 6.3?
 - D. During direct current electrophoresis at pH 8.5, toward which electrode would this amino acid be likely to move?
26. A biochemical buffer is a compound which tends to resist changes in pH even when acids or bases are added. What two properties are required of an effective physiologic buffer? In addition to phosphate, what other physiologic compounds meet these criteria?
27. Name two amino acids whose posttranslational modification confers significant new properties to a protein.
28. Explain why diets deficient in (a) copper (Cu) or (b) ascorbic acid lead to incomplete posttranslational processing of collagen.
29. Describe the role of N-terminal signal sequences in the biosynthesis of certain proteins.

SECTION

II

Enzymes: Kinetics, Mechanism, Regulation, & Role of Transition Metals

CHAPTER

6

Proteins: Myoglobin & Hemoglobin

Peter J. Kennelly, PhD & Victor W. Rodwell, PhD

OBJECTIVES

After studying this chapter, you should be able to:

- Describe the most important structural similarities and differences between myoglobin and hemoglobin.
- Sketch binding curves for the oxygenation of myoglobin and hemoglobin.
- Identify the covalent linkages and other close associations between heme and globin in oxymyoglobin and oxyhemoglobin.

- Explain why the physiologic function of hemoglobin requires a sigmoidal rather than hyperbolic O₂-binding curve.
- Explain the role of the distal histidine on the ability of hemoglobin to bind carbon monoxide (CO).
- Define P₅₀ and indicate its significance in oxygen transport and delivery.
- Describe the structural and conformational changes in hemoglobin that accompany its oxygenation and subsequent deoxygenation.
- Explain the role of 2,3-bisphosphoglycerate (BPG) in oxygen binding and delivery.
- Explain how the Bohr effect enhances the ability of red blood cells to transport CO₂ and deliver it to the lungs.
- Describe the structural consequences to hemoglobin S (HbS) of lowering PO₂.
- Identify the metabolic defect that occurs as a consequence of α and β thalassemias.

BIOMEDICAL IMPORTANCE

The efficient delivery of oxygen from the lungs to the peripheral tissues and the maintenance of tissue reserves to protect against anoxic episodes are essential to health. In mammals, these functions are performed by the homologous heme proteins hemoglobin and myoglobin, respectively. Myoglobin, a monomeric protein of red muscle, binds oxygen tightly as a reserve against oxygen deprivation. The multiple subunits of hemoglobin, a tetrameric protein of erythrocytes, interact in a cooperative fashion that enables this transporter to offload a high proportion of bound O₂ in peripheral tissues while simultaneously retaining the capacity to bind it efficiently in the lungs. In addition to delivering O₂, proton binding to hemoglobin aids in the transport of CO₂, a major product of respiration, to the lungs for disposal. Oxygen delivery is enhanced by the binding of 2,3-bisphosphoglycerate (BPG), which stabilizes the quaternary structure of deoxyhemoglobin. Hemoglobin and myoglobin illustrate both protein structure–function relationships and the molecular basis of genetic disorders such as sickle cell disease and the thalassemias. Cyanide and carbon monoxide (CO) kill because they disrupt the physiologic function of the heme proteins cytochrome oxidase and hemoglobin, respectively.

HEME & FERROUS IRON CONFER THE ABILITY TO STORE & TRANSPORT OXYGEN

Myoglobin and hemoglobin contain **heme**, an iron-containing cyclic tetrapyrrole consisting of four molecules of pyrrole linked by **methyne** bridges. This planar network of conjugated double bonds absorbs visible light and colors heme deep red. The substituents at the β -positions of heme are methyl (M), vinyl (V), and propionate (Pr) groups arranged in the order M, V, M, V, M, Pr, Pr, M (**Figure 6–1**). An atom of ferrous iron (Fe^{2+}) resides at the center of the planar tetrapyrrole. Oxidation of the Fe^{2+} of myoglobin or hemoglobin to Fe^{3+} destroys their biologic activity. Other proteins with metal-containing tetrapyrrole prosthetic groups include the cytochromes (Fe and Cu) and chlorophyll (Mg) (see **Chapter 31**).

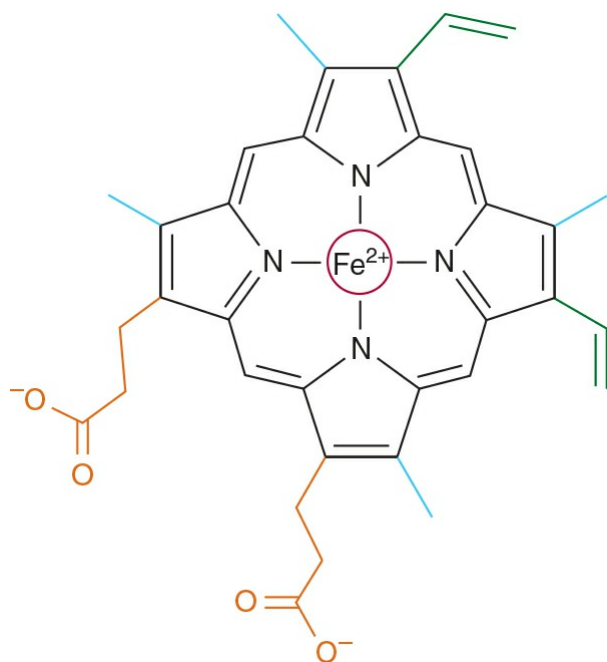

FIGURE 6–1 Heme. The pyrrole rings and methyne bridge carbons are coplanar, and the iron atom (Fe^{2+}) resides in almost the same plane. The fifth and sixth coordination positions of Fe^{2+} are directly perpendicular to—and directly above and below—the plane of the heme ring. Observe the nature of the methyl (blue), vinyl (green), and propionate (orange) substituent groups on the β carbons of the pyrrole rings, the central iron atom (red), and the location of the polar side of the heme ring (at about 7 o'clock) that faces the surface of the myoglobin molecule.

Myoglobin Is Rich in α Helix

Oxygen stored in red muscle myoglobin is released during O₂ deprivation (eg, severe exercise) for use in muscle mitochondria for aerobic synthesis of ATP (see [Chapter 13](#)). A 153-aminoacyl residue polypeptide (MW 17,000), the compactly folded myoglobin molecule measures 4.5 × 3.5 × 2.5 nm ([Figure 6–2](#)). An unusually high proportion, about 75%, of the residues are present in eight right-handed 7 to 20 residue α helices. Starting at the amino terminal, these are termed helices A through H. Typical of globular proteins, the surface of myoglobin is rich in amino acids bearing polar and potentially charged side chains, while—with two exceptions—the interior contains residues that possess nonpolar R groups (eg, Leu, Val, Phe, and Met). The exceptions are the seventh and eighth residues in helices E and F, His E7 and His F8, which lie close to the heme iron, the site of O₂ binding.

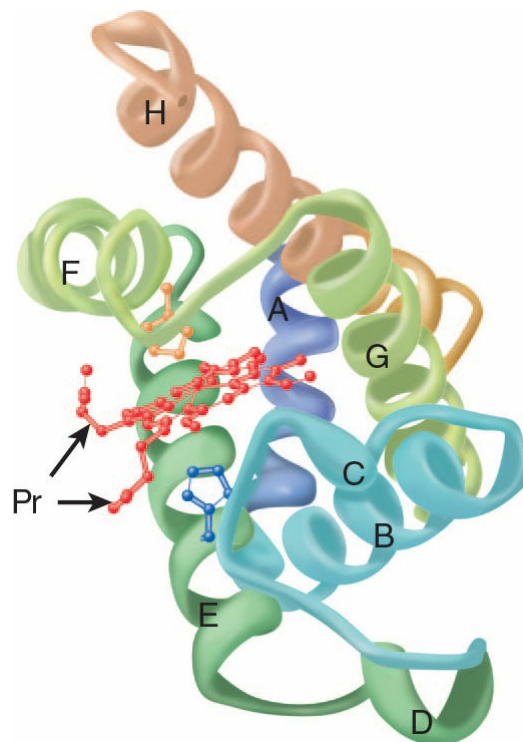

FIGURE 6–2 Three-dimensional structure of myoglobin. Shown is a ribbon diagram tracing the polypeptide backbone of myoglobin. The color of the polypeptide chain is graded along the visible spectrum from blue (N-terminal) to tan (C-terminal). The heme prosthetic group is red. The α-helical regions are designated A through H. The distal (E7) and proximal (F8) histidine residues are highlighted in blue and orange, respectively. Note how the polar propionate substituents (Pr) project out of the heme toward solvent. (Adapted from Protein Data Bank ID no. 1a6n.)

Histidines F8 & E7 Perform Unique Roles in Oxygen Binding

The heme of myoglobin lies in a crevice between helices E and F oriented with its polar propionate groups facing the surface of the globin (Figure 6–2). The remainder resides in the nonpolar interior. The fifth coordination position of the iron is occupied by a nitrogen from the imidazole ring of the **proximal histidine**, His F8. The **distal histidine**, His E7, lies on the side of the heme ring opposite to His F8.

The Iron Moves Toward the Plane of the Heme When Oxygen Is Bound

The iron of unoxygenated myoglobin lies 0.03 nm (0.3 Å) outside the plane of the heme ring, toward His F8. Consequently, the heme “puckers” slightly. When O₂ occupies the sixth coordination position, the iron moves to within 0.01 nm (0.1 Å) of the plane of the heme ring. Oxygenation of myoglobin thus is accompanied by motion of the iron, of His F8, and of residues linked to His F8.

Apomyoglobin Provides a Hindered Environment for the Heme Iron

When O₂ binds to myoglobin, the bond that links the first and second oxygen atoms lies at an angle of 121° to the plane of the heme, orienting the second oxygen away from the distal histidine (Figure 6–3, left). This permits maximum overlap between the iron and one of the lone pairs of electrons on the sp² hybridized oxygen atoms, which lie at an angle of roughly 120° to the axis of the O=O double bond (Figure 6–4, left), and protects oxygen from being displaced by CO. Minute quantities of CO arise from a variety of biologic sources, including the catabolism of red blood cells within the human body, as well as via the incomplete combustion of fossil fuels. CO binds to the iron in free heme 25,000 times more strongly than oxygen. So why is it that CO does not completely displace O₂ from the heme iron present in myoglobin and hemoglobin?

The accepted explanation is that the apoproteins of myoglobin and hemoglobin create a **hindered environment** for their gaseous ligands. When CO binds to free heme, all three atoms (Fe, C, and O) lie **perpendicular** to the plane of the heme. This geometry maximizes the

overlap between the lone pair of electrons on the sp hybridized carbon of the CO molecule and the Fe^{2+} iron (Figure 6–4, right). However, in myoglobin and hemoglobin the distal histidine sterically precludes this preferred, high-affinity orientation of CO while still permitting O_2 to attain its most favorable orientation. Binding at a less favored angle reduces the strength of the heme-CO bond to about 200 times that of the heme- O_2 bond (Figure 6–3, right). Therefore O_2 , which is present in great excess over CO, normally dominates. Nevertheless, about 1% of human myoglobin typically is present combined with CO.

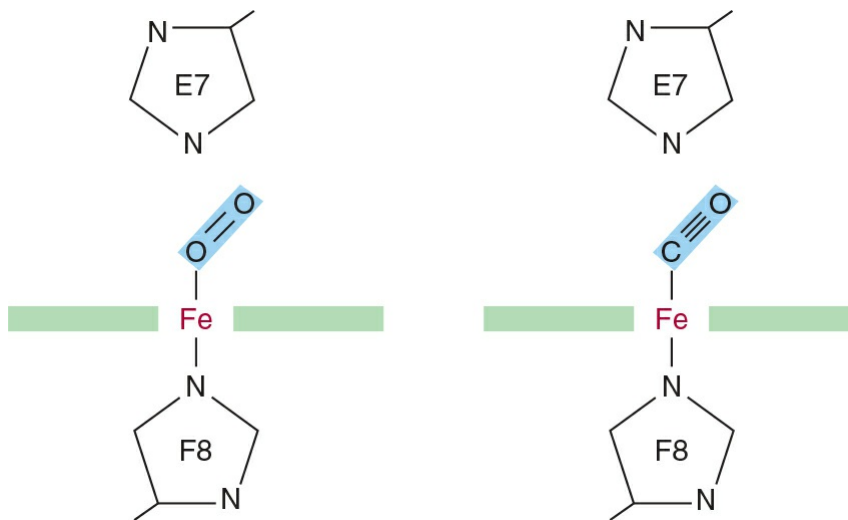

FIGURE 6–3 Angles for bonding of oxygen and carbon monoxide (CO) to the heme iron of myoglobin. The distal E7 histidine hinders bonding of CO at the preferred (90°) angle to the plane of the heme ring.

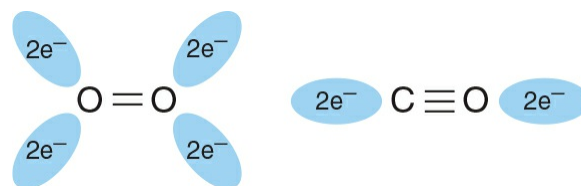

FIGURE 6–4 Orientation of the lone pairs of electrons relative to the O—O and C—O bonds of oxygen and carbon monoxide. In molecular oxygen, formation of the double bond between the two oxygen atoms is facilitated by the adoption of an sp^2 hybridization state by the valence electron of each oxygen atom. As a consequence, the two atoms of the oxygen molecule and each lone pair of electrons are coplanar and separated by an angle of roughly 120° (left). By contrast, the two atoms of carbon monoxide are joined by a triple bond, which requires that the carbon and oxygen atoms adopt an sp hybridization state. In this state, the

lone pairs of electrons and triple bonds are arranged in a linear fashion, where they are separated by an angle of 180° (**right**).

THE OXYGEN DISSOCIATION CURVES FOR MYOGLOBIN & HEMOGLOBIN SUIT THEIR PHYSIOLOGIC ROLES

Why is myoglobin unsuitable as an O_2 transport protein but well suited for O_2 storage? The relationship between the concentration, or partial pressure, of O_2 (PO_2) and the quantity of O_2 bound is expressed as an O_2 saturation isotherm (**Figure 6–5**). The oxygen-binding curve for myoglobin is hyperbolic. Myoglobin therefore loads O_2 readily at the PO_2 of the lung capillary bed (100 mm Hg). However, since myoglobin releases only a small fraction of its bound O_2 at the PO_2 values typically encountered in active muscle (20 mm Hg) or other tissues (40 mm Hg), it represents an ineffective vehicle for delivery of O_2 . However, when strenuous exercise lowers the PO_2 of muscle tissue to about 5 mm of Hg, the dissociation of O_2 from myoglobin permits mitochondrial synthesis of ATP, and hence muscular activity, to continue.

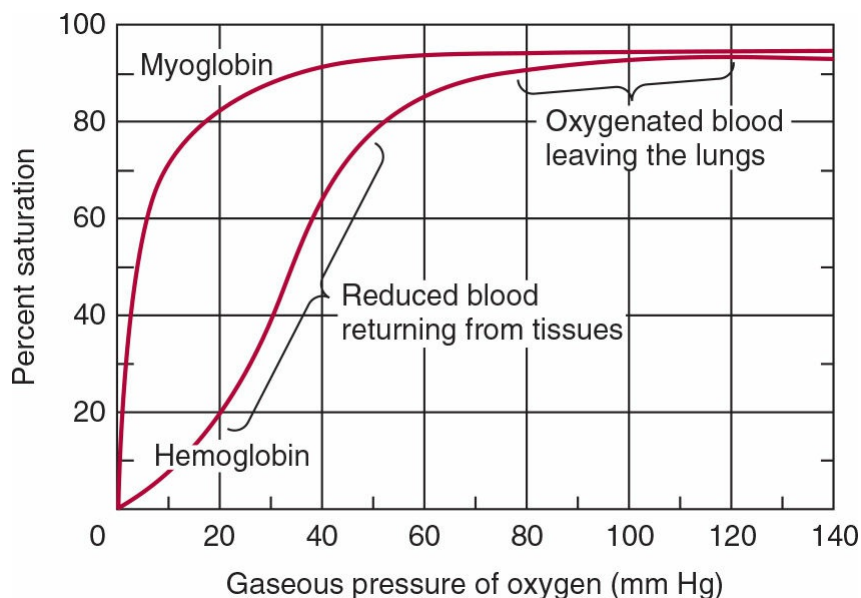

FIGURE 6–5 Oxygen-binding curves of both hemoglobin and myoglobin. Arterial oxygen tension is about 100 mm Hg; mixed venous oxygen tension is about 40 mm Hg; capillary (active muscle) oxygen tension is about 20 mm Hg; and the minimum oxygen tension required for

cytochrome oxidase is about 5 mm Hg. Association of chains into a tetrameric structure (hemoglobin) results in much greater oxygen delivery than would be possible with single chains. (Modified, with permission, from Scriver CR, et al (editors): *The Molecular and Metabolic Bases of Inherited Disease*, 7th ed. McGraw-Hill; 1995.)

By contrast, hemoglobin behaves as if it were two proteins. At high PO_2 , 100 mm Hg and above, it displays a high affinity for oxygen that enables it to bind oxygen to nearly every available heme iron when in the lungs. This form of the protein is commonly referred to as **R**, for **relaxed, state** hemoglobin. At the much lower PO_2 values encountered in peripheral tissues, 40 mm Hg and below, hemoglobin exhibits a much lower apparent affinity for oxygen. Transition of hemoglobin to this low affinity, **taut** or **T state** enables it to release a large proportion of the oxygen previously picked up in the lungs. This dynamic interchange between the R and T state serves as the foundation for hemoglobin's sigmoidal O_2 -binding curve.

THE ALLOSTERIC PROPERTIES OF HEMOGLOBINS RESULT FROM THEIR QUATERNARY STRUCTURES

The properties of individual hemoglobins are consequences of their quaternary as well as secondary and tertiary structures. The quaternary structure of hemoglobin confers striking additional properties, absent from monomeric myoglobin, which adapts it to its unique biologic roles. The **allosteric** (Gk *allos* "other," *steros* "space") properties of hemoglobin provide, in addition, a model for understanding other allosteric proteins (see [Chapter 17](#)).

Hemoglobin Is Tetrameric

Hemoglobins are tetramers composed of pairs of two different polypeptide subunits ([Figure 6–6](#)). Greek letters are used to designate each subunit type. The subunit composition of the principal hemoglobins are $\alpha_2\beta_2$ (HbA; normal adult hemoglobin), $\alpha_2\gamma_2$ (HbF; fetal hemoglobin), $\alpha_2\beta^S_2$ (HbS; sickle cell hemoglobin), and $\alpha_2\delta_2$ (HbA₂; a minor adult hemoglobin). The primary structures of the β , γ , and δ chains of human hemoglobin are highly conserved.

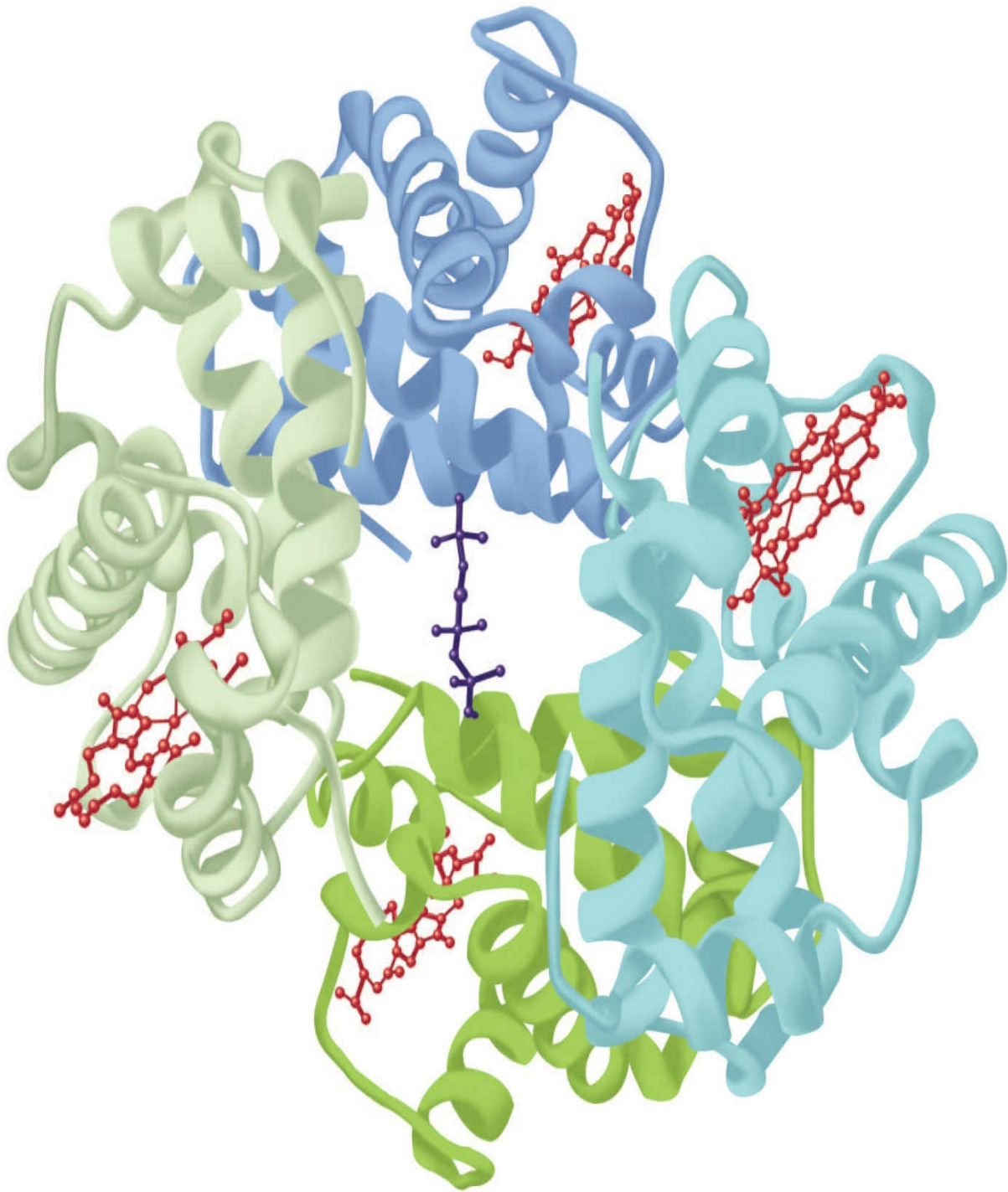

FIGURE 6–6 Hemoglobin. Shown is the three-dimensional structure of deoxyhemoglobin with a molecule of 2,3-bisphosphoglycerate (dark blue) bound. The two α subunits are colored in the darker shades of green and blue, the two β subunits in the lighter shades of green and blue, and the heme prosthetic groups in red. (Adapted from Protein Data Bank ID no. 1b86.)

Myoglobin & the β Subunits of Hemoglobin Share

Almost Identical Secondary and Tertiary Structures

Despite differences in the kind and number of amino acids present, myoglobin and the β polypeptide of hemoglobin A share almost identical secondary and tertiary structures. Similarities include the location of the heme and the helical regions, and the presence of amino acids with similar properties at comparable locations. Although it possesses seven rather than eight helical regions, the α polypeptide of hemoglobin also closely resembles myoglobin.

Oxygenation of Hemoglobin Triggers Conformational Changes in the Apoprotein

Hemoglobins can bind up to four molecules of O_2 per tetramer, one per heme. In addition, hemoglobin will bind a molecule of O_2 more readily if other O_2 molecules are already bound (Figure 6–5). Termed **cooperative binding**, this phenomenon permits hemoglobin to maximize both the quantity of O_2 loaded at the PO_2 of the lungs and the quantity of O_2 released at the PO_2 of the peripheral tissues. These cooperative interactions, an exclusive property of certain *multimeric* proteins, are critically important to aerobic life.

P_{50} Expresses the Relative Affinities of Different Hemoglobins for Oxygen

The quantity P_{50} , a measure of O_2 concentration, is the partial pressure of O_2 at which a given hemoglobin reaches half-saturation. Depending on the organism, P_{50} can vary widely, but in all instances, it exceeds the normal PO_2 of the peripheral tissues. For example, the values of P_{50} for HbA and HbF are 26 and 20 mm Hg, respectively. In the placenta, this difference enables HbF to extract oxygen from the HbA in the mother's blood. However, HbF is suboptimal postpartum since its higher affinity for O_2 limits the quantity of O_2 delivered to the tissues.

The subunit composition of hemoglobin tetramers undergoes complex changes during development. The human fetus initially synthesizes a $\xi_2\varepsilon_2$ tetramer. By the end of the first trimester, ξ and ε subunits have been replaced by α and γ subunits, forming HbF ($\alpha_2\gamma_2$), the hemoglobin of late

fetal life. While synthesis of β subunits begins in the third trimester, the replacement of γ subunits by β subunits to yield adult HbA ($\alpha_2\beta_2$) does not reach completion until several weeks postpartum (**Figure 6–7**).

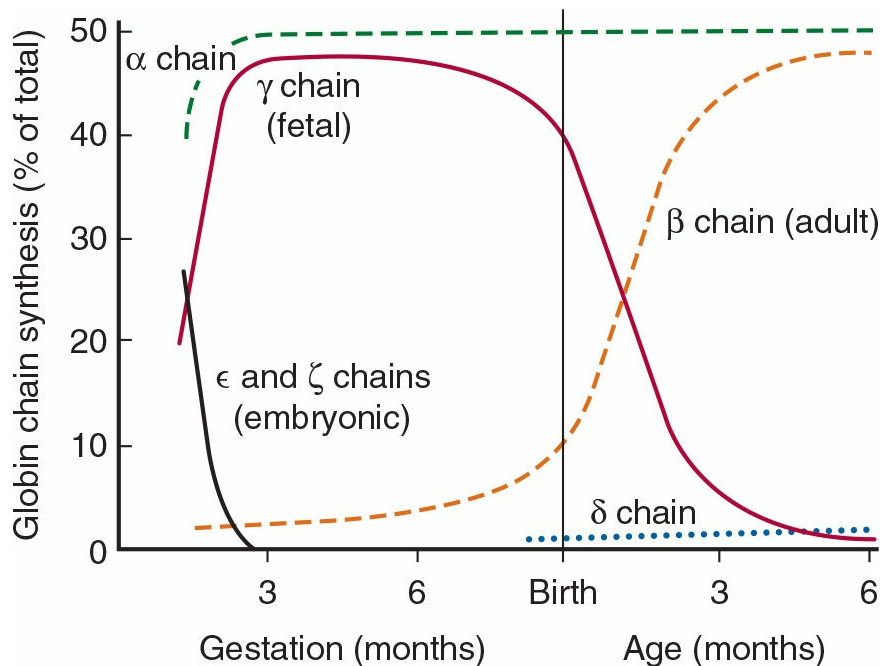

FIGURE 6–7 Developmental pattern of the quaternary structure of fetal and newborn hemoglobins. (Reproduced, with permission, from Ganong WF: *Review of Medical Physiology*, 20th ed. McGraw-Hill; 2001.)

Oxygenation of Hemoglobin Is Accompanied by Large Conformational Changes

The binding of the first molecule of O_2 to deoxyHb shifts the heme iron toward the plane of the heme ring (**Figure 6–8**). This motion is transmitted through the proximal (F8) histidine and the residues attached thereto to the entire tetramer, triggering the rupture of salt bridges formed by the carboxyl terminal residues of all four subunits. As a result, one pair of α/β subunits rotates 15° with respect to the other, compacting the tetramer (**Figure 6–9**). Profound changes in secondary, tertiary, and quaternary structures accompany the O_2 -induced transition of hemoglobin from the low-affinity T state to the high-affinity R state. These changes significantly increase the affinity of the remaining unoxygenated hemes for O_2 , as subsequent binding events require the rupture of fewer salt bridges (**Figure 6–10**). The terms T and R also are used to refer to the low-affinity and high-affinity conformations of allosteric enzymes,

respectively.

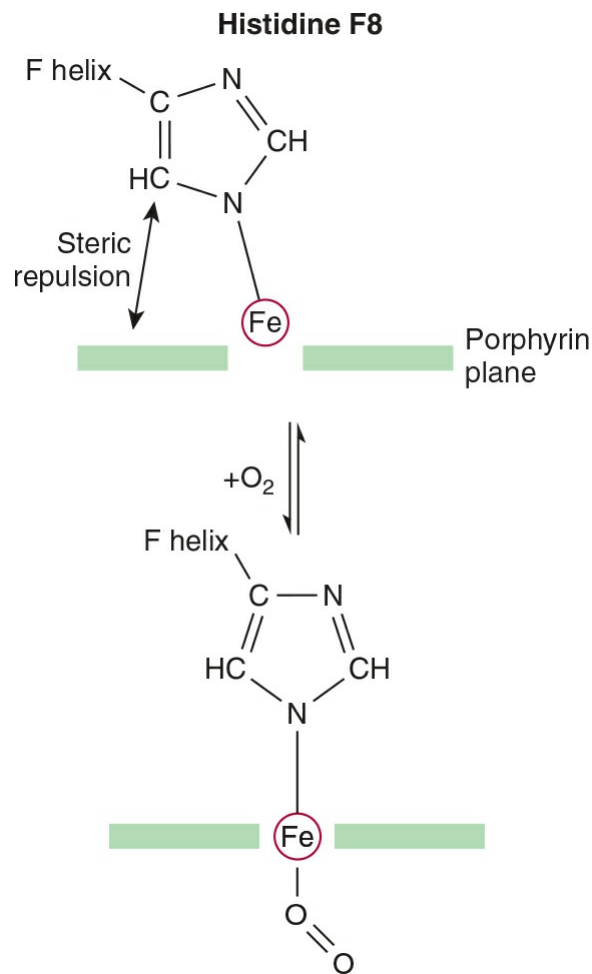

FIGURE 6–8 On oxygenation of hemoglobin the iron atom moves into the plane of the heme. Histidine F8 and its associated aminoacyl residues are pulled along with the iron atom. For a representation of this motion, see <http://www.rcsb.org/pdb/101/motm.do?momID=41>.

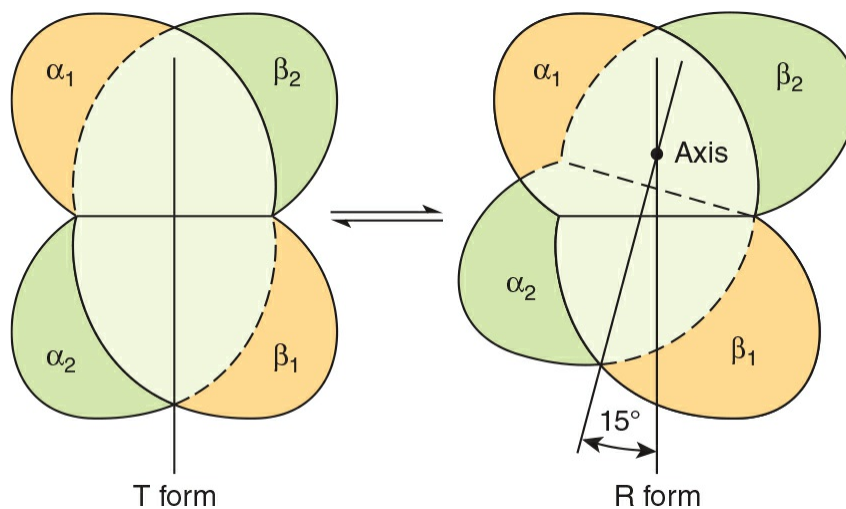

FIGURE 6–9 During transition of the T form to the R form of hemoglobin, the $\alpha_2\beta_2$ pair of subunits (green) rotates through 15° relative to the pair of $\alpha_1\beta_1$ subunits (yellow). The axis of rotation is eccentric, and the $\alpha_2\beta_2$ pair also shifts toward the axis somewhat. In the representation, the tan $\alpha_1\beta_1$ pair is shown fixed while the green $\alpha_2\beta_2$ pair of subunits both shifts and rotates.

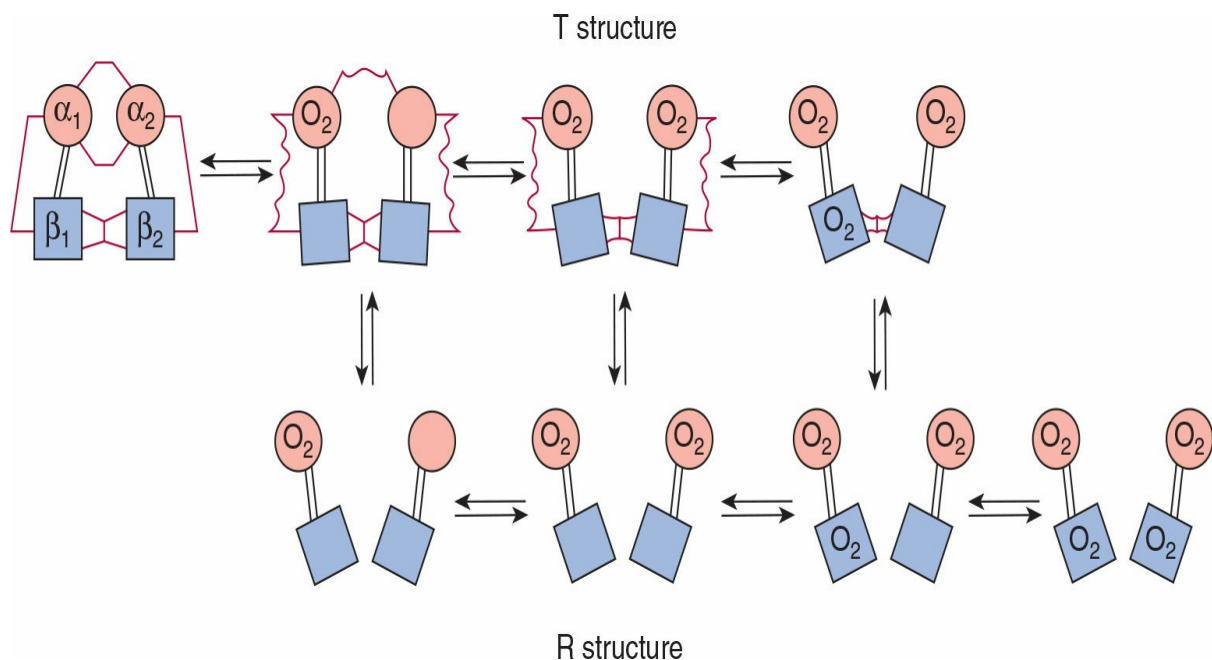
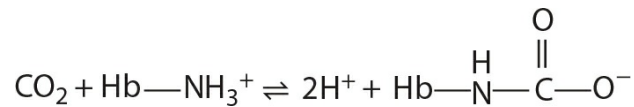

FIGURE 6–10 Transition from the T structure to the R structure. In this model, salt bridges (red lines) linking the subunits in the T structure break progressively as oxygen is added, and even those salt bridges that have not yet ruptured are progressively weakened (wavy red lines). The transition from T to R does not take place after a fixed number of oxygen molecules have been bound but becomes more probable as each successive oxygen binds. The transition between the two structures is influenced by protons, carbon dioxide, chloride, and 2,3-bisphosphoglycerate (BPG); the higher their concentration, the more oxygen must be bound to trigger the transition. Fully oxygenated molecules in the T structure and fully deoxygenated molecules in the R structure are not shown because they are unstable. (Modified and redrawn, with permission, from Perutz MF: Hemoglobin structure and respiratory transport. Sci Am [Dec] 1978;239:92.)

Hemoglobin Assists in the Transport of CO₂ to the Lungs

In addition to transporting O₂ from the lungs to peripheral tissues, red blood cells must scavenge CO₂, the byproduct of respiration, from peripheral tissues for disposal in the lungs. About 15% of the CO₂ in venous blood is carried by hemoglobin as carbamates formed with the amino terminal nitrogens of the polypeptide chains:



Carbamate formation changes the charge on amino terminals from positive to negative, favoring salt bridge formation between α and β chains. The remaining CO₂ is carried mostly as bicarbonate, which is formed in erythrocytes by the hydration of CO₂ to carbonic acid (H₂CO₃), a process catalyzed by carbonic anhydrase. At the pH of venous blood, H₂CO₃ dissociates into bicarbonate and a proton.

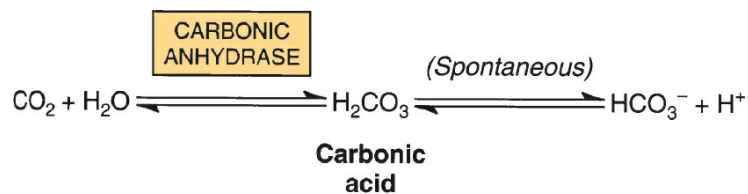

T-state hemoglobin binds two protons per tetramer. Not only does proton binding help buffer against the acidification of the blood in the peripheral circulation that results from the formation of carbonic acid, it enhances the quantity of CO₂ absorbed by the red blood cells by favoring the conversion of CO₂ to carbonic acid and hence to bicarbonate. CO₂, in turn, enhances the delivery of O₂ to respiring tissues by stabilizing the T state by inducing carbamation and lowering the pH. In lungs, this process reverses. As O₂ binds to deoxyhemoglobin, the resulting transition to the R state triggers release of bound protons and the breakdown of carbamates, releasing CO₂. The liberated protons combine with bicarbonate to form carbonic acid. H₂CO₃ is subsequently dehydrated, a process catalyzed by the enzyme carbonic anhydrase, to form CO₂, which is exhaled (**Figure 6–11**). This coupling of the interconversion of CO₂ and H₂CO₃ with the reciprocal binding of protons and O₂ by T- and R-state hemoglobin, respectively, is termed the **Bohr effect**.

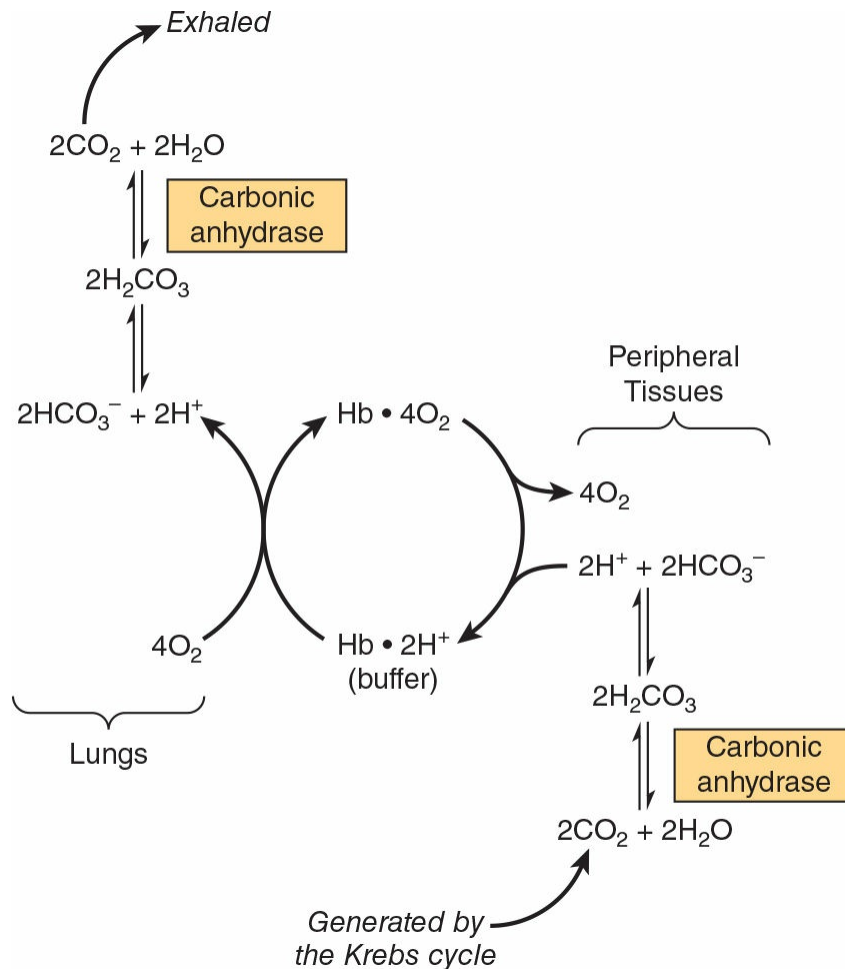

FIGURE 6–11 The Bohr effect. Carbon dioxide generated in peripheral tissues combines with water to form carbonic acid, which dissociates into protons and bicarbonate ions. Deoxyhemoglobin acts as a buffer by binding protons and delivering them to the lungs. In the lungs, the uptake of oxygen by hemoglobin releases protons that combine with bicarbonate ion, forming carbonic acid, which when dehydrated by carbonic anhydrase becomes carbon dioxide, which then is exhaled.

Protons Arise From Rupture of Salt Bridges When O_2 Binds

The Bohr effect is dependent on the cooperative interactions among the subunits, and their associated heme groups, of the hemoglobin tetramer. In the lungs, the partial pressure of oxygen drives the conversion of hemoglobin from the T to the R state, breaking the salt bridges involving β -chain residue His 146. The subsequent dissociation of protons from His 146 then drives the conversion of bicarbonate to carbonic acid (Figure 6–11). In respiring tissues, the high concentration of CO_2 drives the

formation of carbonic acid and the acidification of red blood cells. Upon the release of O_2 , the T structure and its salt bridges reform. This conformational change increases the pK_a of the β -chain His 146 residues, which bind protons. By stabilizing the formation of T-state hemoglobin, the CO_2 -driven increase in proton concentration enhances the release of O_2 .

2,3-BPG Stabilizes the T Structure of Hemoglobin

In peripheral tissues, CO_2 -induced decreases in red blood cell pH promotes the synthesis of 2,3-BPG in erythrocytes. When hemoglobin is in the T state, a central cavity forms at the interface of its four subunits that can bind one molecule of BPG (Figure 6–6), which forms salt bridges with the terminal amino groups of both β chains via Val NA1 and with Lys EF6 and His H21 (Figure 6–12). BPG therefore stabilizes deoxygenated (T-state) hemoglobin by forming additional salt bridges that must be broken prior to conversion to the R state.

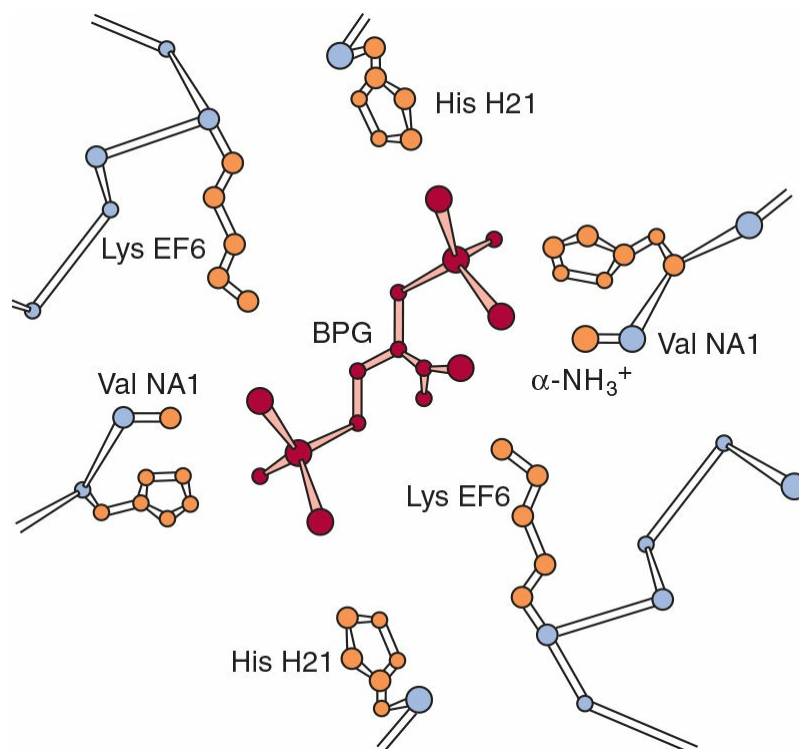

FIGURE 6–12 Mode of binding of 2,3-bisphosphoglycerate (BPG) to human deoxyhemoglobin. BPG interacts with three positively charged groups on each β chain. (Based on Arnone A: X-ray diffraction study of binding of 2,3-diphosphoglycerate to human deoxyhemoglobin. *Nature*

1972;237:146. Copyright © 1972. Adapted by permission from Macmillan Publishers Ltd.)

Synthesis of BPG from the glycolytic intermediate 1,3-BPG is catalyzed by the bifunctional enzyme **2,3-bisphosphoglycerate synthase/2-phosphatase** (BPGM). BPG is hydrolyzed to 3-phosphoglycerate by the 2-phosphatase activity of BPGM and to 2-phosphoglycerate by a second enzyme, multiple inositol polyphosphate phosphatase (MIPP). The activities of these enzymes, and hence the level of BPG in erythrocytes, are sensitive to pH. As a consequence, the binding of BPG reinforces the impact of carbonic acid–derived protons in shifting the R-T equilibrium in favor of the T state, increasing the quantity of O₂ released in peripheral tissues.

In the fetal hemoglobin, residue H21 of the γ subunit is Ser rather than His. Since Ser cannot form a salt bridge, BPG binds more weakly to HbF than to HbA. The lower stabilization afforded to the T state by BPG accounts for HbF having a higher affinity for O₂ than HbA.

Adaptation to High Altitude

Physiologic changes that accompany prolonged exposure to high altitude include increases in the number of erythrocytes, the concentration of hemoglobin within them, and the synthesis of BPG. Elevated BPG lowers the affinity of HbA for O₂ (increases P₅₀), which enhances the release of O₂ at peripheral tissues.

NUMEROUS MUTATIONS AFFECTING HUMAN HEMOGLOBINS HAVE BEEN IDENTIFIED

Mutations in the genes that encode the α or β subunits of hemoglobin potentially can affect its biologic function. However, almost all of the over 1100 known genetic mutations affecting human hemoglobins are both rare and benign, presenting no clinical abnormalities. When a mutation does compromise biologic function, the condition is termed a **hemoglobinopathy**. It is estimated that more than 7% of the globe's population are carriers for hemoglobin disorders. The URL <http://globin.cse.psu.edu/> (Globin Gene Server) provides information about—and links for—normal and mutant hemoglobins. Selected examples are described below.

Methemoglobin & Hemoglobin M

In methemoglobinemia, the heme iron is ferric rather than ferrous, rendering methemoglobin unable to bind or transport O₂. Normally, the Fe³⁺ of methemoglobin is returned to Fe²⁺ state through the action of the enzyme methemoglobin reductase. Methemoglobin levels can rise to pathophysiologically significant levels from a number of causes: oxidation of Fe²⁺ to Fe³⁺ as a side effect of agents such as sulfonamides, reductions in the activity of methemoglobin reductase, or inheritance of the gene for a mutationally altered form of hemoglobin called HbM.

In hemoglobin M, histidine F8 (His F8) has been replaced by tyrosine. The iron of HbM forms a tight ionic complex with the phenolate anion of tyrosine that stabilizes the Fe³⁺ form. In α-chain hemoglobin M variants, the R-T equilibrium favors the T state. Oxygen affinity is reduced, and the Bohr effect is absent. β-Chain hemoglobin M variants exhibit R-T switching, and the Bohr effect is therefore present.

Mutations that favor the R state (eg, hemoglobin Chesapeake) increase O₂ affinity. These hemoglobins therefore fail to deliver adequate O₂ to peripheral tissues. The resulting tissue hypoxia leads to **polycythemia**, an increased concentration of erythrocytes.

Hemoglobin S

In HbS, the nonpolar amino acid valine has replaced the polar surface residue Glu6 of the β subunit, generating a hydrophobic “**sticky patch**” on the surface of the β subunit of both oxyHbS and deoxyHbS. Both HbA and HbS contain a complementary sticky patch on their surfaces that is exposed only in the deoxygenated T state. Thus, at low PO₂, deoxyHbS can polymerize to form long, insoluble fibers. Binding of deoxyHbA terminates fiber polymerization, since HbA lacks the second sticky patch necessary to bind another Hb molecule (**Figure 6–13**). These twisted helical fibers distort the erythrocyte into a characteristic sickle shape, rendering it vulnerable to lysis in the interstices of the splenic sinusoids. They also cause multiple secondary clinical effects. A low PO₂, such as that at high altitudes, exacerbates the tendency to polymerize. The terms sickle cell trait and sickle cell disease refer to persons in whom either one or both beta subunit genes are mutated, respectively. Emerging treatments for sickle cell disease include inducing HbF expression to inhibit the polymerization of HbS, stem cell transplantation, and, in the future, gene

therapy.

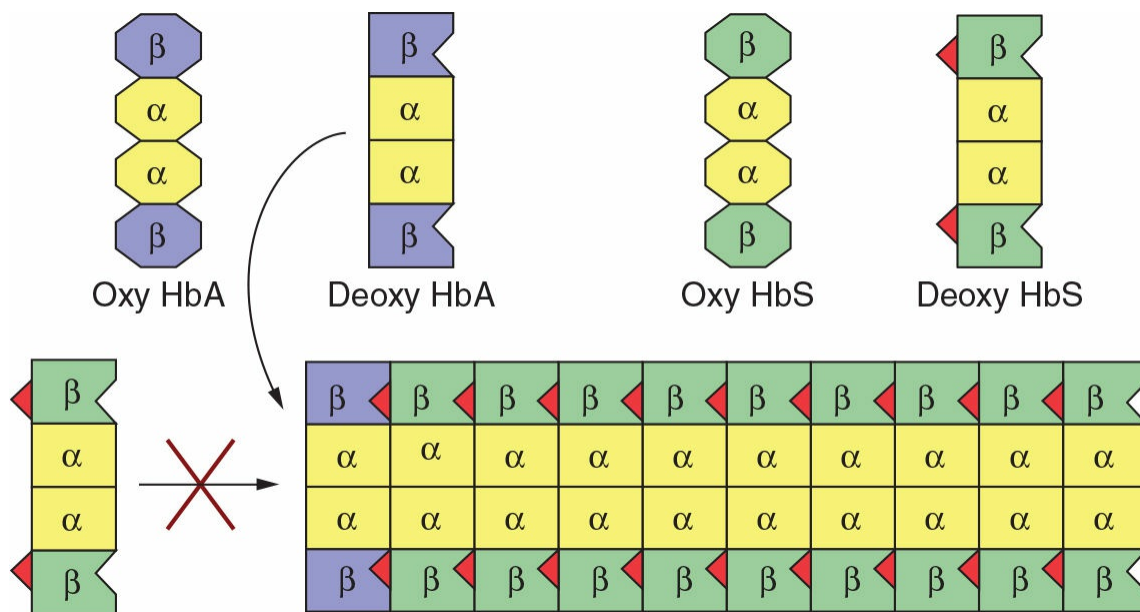

FIGURE 6–13 Polymerization of deoxyhemoglobin S. The dissociation of oxygen from hemoglobin S (HbS) unmasks a sticky patch (red triangle) on the surface of its β subunits (green) that can adhere to a complementary site on the β subunits of other molecules of deoxyHbS. Polymerization to a fibrous polymer is interrupted deoxyHbA, whose β subunits (lavender) lack the sticky patch required for binding additional HbS subunits.

BIOMEDICAL IMPLICATIONS

Myoglobinuria

Following massive crush injury to skeletal muscle followed by renal damage, released myoglobin may appear in the urine. Myoglobin can be detected in plasma following a myocardial infarction, but assay of serum troponin, lactate dehydrogenase isozymes, or creatine kinase (see [Chapter 7](#)) provides a more sensitive index of myocardial injury.

Anemias

Anemias, reductions in the number of red blood cells or of hemoglobin in the blood, can reflect impaired synthesis of hemoglobin (eg, in iron deficiency; see [Chapter 53](#)) or impaired production of erythrocytes (eg, in folic acid or vitamin B₁₂ deficiency; see [Chapter 44](#)). Diagnosis of anemias begins with spectroscopic measurement of blood hemoglobin levels.

Thalassemias

The genetic defects known as thalassemias result from the partial or total absence of one or more α or β chains of hemoglobin. Over 750 different mutations have been identified, but only three are common. Either the α chain (α thalassemias) or β chain (β thalassemias) can be affected. A superscript indicates whether a subunit is completely absent (α^0 or β^0) or whether its synthesis is reduced (α^- or β^-). Apart from marrow transplantation, treatment is symptomatic.

Certain mutant hemoglobins are common in many populations, and a patient may inherit more than one type. Hemoglobin disorders thus present a complex pattern of clinical phenotypes. The use of DNA probes for their diagnosis is considered in [Chapter 39](#).

GLYCATED HEMOGLOBIN (HbA_{1c})

Blood glucose that enters the erythrocytes can form a covalent adduct with the ϵ -amino groups of lysyl residues and the N-terminal valines of hemoglobin β chains, a process referred to as **glycation**. Unlike glycosylation (see [Chapter 46](#)), glycation is not enzyme-catalyzed. The fraction of hemoglobin glycated, normally about 5%, is proportionate to blood glucose concentration. Since the half-life of an erythrocyte is typically 60 days, the level of glycated hemoglobin (HbA_{1c}) reflects the mean blood glucose concentration over the preceding 6 to 8 weeks. Measurement of HbA_{1c} therefore provides valuable information for management of diabetes mellitus.

SUMMARY

- Myoglobin is monomeric; hemoglobin is a tetramer of two subunit types ($\alpha_2\beta_2$ in HbA). Despite having different primary structures, myoglobin and the subunits of hemoglobin have nearly identical secondary and tertiary structures.
- Heme, an essentially planar, slightly puckered, cyclic tetrapyrrole has a central Fe^{2+} linked to all four nitrogen atoms of the heme, to histidine F8, and, in oxyMb and oxyHb, also to O_2 .
- The O_2 -binding curve for myoglobin is hyperbolic, but for hemoglobin it is sigmoidal, a consequence of cooperative interactions in the tetramer.

- Cooperativity arises from the ability of hemoglobin to exist in two different conformational states, a relaxed or R state in which all four subunits exhibit a high affinity for oxygen and a taut or T state where all four subunits display a low affinity for oxygen.
- The high levels of O₂ in the lungs drive the R-T equilibrium in favor of the R state, while acidification of the red blood cells generated from the catalytic hydration of CO₂ in the peripheral tissues favors the T state. Cooperativity thus maximizes the ability of hemoglobin both to load O₂ at the PO₂ of the lungs and to deliver O₂ at the PO₂ of the tissues.
- Relative affinities of different hemoglobins for oxygen are expressed as P₅₀, the PO₂ that half-saturates them with O₂. Hemoglobins saturate at the partial pressures of their respective respiratory organ, for example, the lung or placenta.
- On oxygenation of hemoglobin, the iron and histidine F8 move toward the heme ring. The resulting conformational changes in the hemoglobin tetramer include the rupture of salt bonds and loosening of the quaternary structure that facilitates binding of additional O₂.
- 2,3-BPG in the central cavity of deoxyHb forms salt bonds with the β subunits that stabilize T-state hemoglobin. On oxygenation, the central cavity contracts upon transition to the R state, BPG is extruded, and the quaternary structure loosens.
- Hemoglobin assists in CO₂ transport from peripheral tissues to the lungs via the formation of carbamates and the **Bohr effect**, a consequence of the binding of protons to T-state, but not R-state, hemoglobin. Proton binding enhances the conversion of CO₂ to water-soluble carbonic acid and bicarbonate. In the lungs, the release of protons from oxygenated R-state hemoglobin favors the conversion of bicarbonate and carbonic acid to CO₂, which is exhaled.
- In sickle cell hemoglobin (HbS), Val replaces Glu₆ of the β subunit of HbA, creating a “sticky patch” that has a complement on deoxyHb (but not on oxyHb). DeoxyHbS polymerizes at low O₂ concentrations, forming fibers that distort erythrocytes into sickle shapes.
- α and β Thalassemias are anemias that result from reduced production of α and β subunits of HbA, respectively.

REFERENCES

- Cho J, King JS, Qian X, et al: Dephosphorylation of 2,3-bisphosphoglycerate by MIPP expands the regulatory capacity of the Rapoport-Luebering glycolytic shunt. *Proc Natl Acad Sci USA* 2008;105:5998.
- Lukin JA, Ho C: The structure–function relationship of hemoglobin in solution at atomic resolution. *Chem Rev* 2004;104:1219.
- Ordway GA, Garry DJ: Myoglobin: An essential hemoprotein in striated muscle. *J Exp Biol* 2004;207:3441.
- Papanikolaou E, Anagnou NP: Major challenges for gene therapy of thalassemia and sickle cell disease. *Curr Gene Ther* 2010;10:404.
- Piel FB: The present and future global burden of the inherited disorders of hemoglobin. *Hematol Oncol Clin North Am* 2016;30:327.
- Schrier SL, Angelucci E: New strategies in the treatment of the thalassemias. *Annu Rev Med* 2005;56:157.
- Steinberg MH, Brugnara C: Pathophysiological-based approaches to treatment of sickle-cell disease. *Annu Rev Med* 2003;54:89.
- Umbreit J: Methemoglobin—it’s not just blue: a concise review. *Am J Hematol* 2007;82:134.
- Weatherall DJ, Akinyanju O, Fucharoen S, et al: Inherited disorders of hemoglobin. In: Jamison DT, Breman JG, Measham AR (editors). *Disease Control Priorities in Developing Countries*,. Oxford University Press and the World Bank, 2006:663–680.
- Weatherall DJ, Clegg JB, Higgs DR, et al: The hemoglobinopathies. In: Scriver CR, Sly WS, Childs B, et al (editors). *The Metabolic Basis of Inherited Disease*, 8th ed. McGraw-Hill, 2000:4571.
- Yuan Y, Tam MF, Simplaceanu V, Ho C: New look at hemoglobin allostery. *Chem Rev* 2015;115:1702.

Enzymes: Mechanism of Action

Peter J. Kennelly, PhD & Victor W. Rodwell, PhD

OBJECTIVES

After studying this chapter, you should be able to:

- Describe the structural relationships between specific B vitamins and certain coenzymes.
- Outline the four principal catalytic mechanisms and how they can be combined by enzymes to facilitate chemical reactions.
- Explain the concept of an “induced fit” and how it facilitates catalysis.
- Outline the underlying principles of enzyme-linked immunoassays.
- Describe how coupling an enzyme to the activity of a dehydrogenase can simplify many enzyme assays.
- Identify proteins whose plasma levels are used for diagnosis and prognosis.
- Describe the application of restriction endonucleases and of restriction fragment length polymorphisms in the detection of genetic diseases.
- Illustrate the utility of site-directed mutagenesis for the identification of aminoacyl residues that are involved in the

recognition of substrates or allosteric effectors, or in the mechanism of catalysis.

- Describe how “affinity tags” can facilitate purification of a protein expressed from its cloned gene.
- Indicate the function of specific proteases in the purification of affinity-tagged enzymes.
- Discuss the events that led to the discovery that RNAs can act as enzymes, and briefly describe the evolutionary concept of an “RNA world.”

BIOMEDICAL IMPORTANCE

Enzymes, which catalyze the chemical reactions that make life on the earth possible, participate in the breakdown of nutrients to supply energy and chemical building blocks; the assembly of those building blocks into proteins, DNA, membranes, cells, and tissues; and the harnessing of energy to power cell motility, neural function, and muscle contraction. Almost all enzymes are proteins. Notable exceptions include ribosomal RNAs and a handful of RNA molecules imbued with endonuclease or nucleotide ligase activity known collectively as ribozymes. The ability to detect and to quantify the activity of specific enzymes in blood, other tissue fluids, or cell extracts provides information that complements the physician’s ability to diagnose many diseases. Many pathologic conditions are the direct consequence of changes in the quantity or in the catalytic activity of key enzymes that result from genetic defects, nutritional deficits, tissue damage, toxins, or infection by viral or bacterial pathogens (eg, *Vibrio cholerae*).

In addition to serving as the catalysts for all metabolic processes, the impressive catalytic activity, substrate specificity, and stereospecificity of enzymes enables them to fulfill unique roles in human health and well-being. The protease rennin, for example, is utilized in the production of cheeses, while lactase is employed to remove lactose from milk to benefit lactose-intolerant individuals. Proteases and amylases augment the capacity of detergents to remove dirt and stains, while other enzymes can participate in the stereospecific synthesis of complex drugs or antibiotics.

ENZYMES ARE EFFECTIVE & HIGHLY SPECIFIC CATALYSTS

The enzymes that catalyze the conversion of one or more compounds (**substrates**) into one or more different compounds (**products**) generally enhance the rates of the corresponding noncatalyzed reaction by factors of 10^6 or more. Enzymes may undergo transient modification during catalysis, but are neither consumed nor *permanently* altered. In addition to being highly efficient, enzymes are also extremely *selective*. Unlike most catalysts used in synthetic chemistry, enzymes are specific not simply for the type of reaction catalyzed, but also for a single substrate or a small set of closely related substrates. Most enzymes are *stereospecific* catalysts that typically act upon only one stereoisomer of a given compound—for example, D- but not L-sugars, L- but not D-amino acids. Since they bind substrates through at least “three points of attachment,” enzymes also can produce chiral products from nonchiral substrates. **Figure 7–1** illustrates why the enzyme-catalyzed reduction of the nonchiral substrate pyruvate produces exclusively L-lactate, not a racemic mixture of D- and L-lactate. The exquisite specificity of enzyme catalysts imbues living cells with the ability to simultaneously conduct and independently control a broad spectrum of biochemical processes.

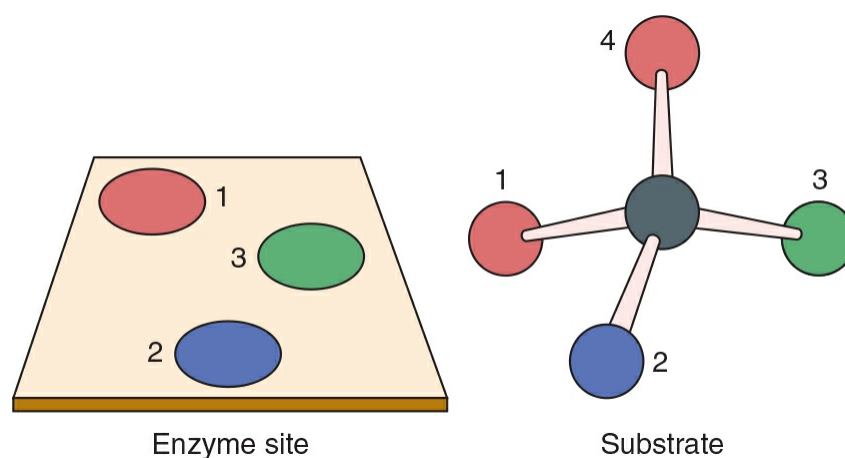

FIGURE 7–1 Planar representation of the “three-point attachment” of a substrate to the active site of an enzyme. Although atoms 1 and 4 are identical, once atoms 2 and 3 are bound to their complementary sites on the enzyme, only atom 1 can bind. Once bound to an enzyme, apparently identical atoms thus may be distinguishable, permitting a stereospecific chemical change.

ENZYMES ARE CLASSIFIED BY REACTION TYPE

Some of the names for enzymes first described in the earliest days of biochemistry persist in use to this day. Examples include pepsin, trypsin, and amylase. Early biochemists generally named newly discovered enzymes by adding the suffix *-ase* to a descriptor for the type of reaction catalyzed. For example, enzymes that remove the elements of hydrogen, H_2 or H^- plus H^+ generally are referred to as *dehydrogenases*, enzymes that hydrolyze proteins as *proteases*, and enzymes that catalyze rearrangements in configuration as *isomerases*. In many cases, these general descriptors were supplemented with terms indicating the particular substrate on which the enzyme acts (*xanthine oxidase*), its source (*pancreatic ribonuclease*), its mode of regulation (*hormone-sensitive lipase*), or a characteristic feature of its mechanism of action (*cysteine protease*). Where needed, alphanumeric designators can be added to identify multiple forms, or isozymes, of an enzyme (eg, RNA polymerase *III*; protein kinase *Cβ*).

As more enzymes were discovered, these early naming conventions increasingly resulted in the inadvertent designation of some enzymes by multiple names or the assignment of duplicate names to enzymes exhibiting similar catalytic capabilities. To address these problems, the International Union of Biochemistry (IUB) developed a system of enzyme nomenclature in which each enzyme has a unique name and code number that identify the *type* of reaction catalyzed and the *substrates* involved. Enzymes are grouped into the following six classes:

1. **Oxidoreductases**—enzymes that catalyze oxidations and reductions.
2. **Transferases**—enzymes that catalyze transfer of moieties such as glycosyl, methyl, or phosphoryl groups.
3. **Hydrolases**—enzymes that catalyze *hydrolytic* cleavage of C—C, C—O, C—N, and other covalent bonds.
4. **Lyases**—enzymes that catalyze cleavage of C—C, C—O, C—N, and other covalent bonds by *atom elimination*, generating double bonds.
5. **Isomerases**—enzymes that catalyze geometric or structural changes *within* a molecule.
6. **Ligases**—enzymes that catalyze the joining together (ligation) of two molecules in reactions coupled to the hydrolysis of ATP.

The IUB name of hexokinase is ATP:D-hexose 6-phosphotransferase E.C. 2.7.1.1. This name identifies hexokinase as a member of class 2

(transferases), subclass 7 (transfer of a phosphoryl group), sub-subclass 1 (alcohol is the phosphoryl acceptor), and “hexose-6” indicates that the alcohol phosphorylated is on carbon six of a hexose. While EC numbers have proven particularly useful to differentiate enzymes with similar functions or similar catalytic activities, IUB names tend to be lengthy and cumbersome. Consequently, hexokinase and many other enzymes commonly are referred to using their traditional, albeit sometimes ambiguous names.

PROSTHETIC GROUPS, COFACTORS, & COENZYMES PLAY IMPORTANT ROLES IN CATALYSIS

Many enzymes contain small molecules or metal ions that participate directly in substrate binding or in catalysis. Termed **prosthetic groups**, **cofactors**, and **coenzymes**, they extend the repertoire of catalytic capabilities beyond those afforded by the functional groups present on the aminoacyl side chains of peptides.

Prosthetic Groups

Prosthetic groups are tightly and stably incorporated into a protein's structure by covalent or noncovalent forces. Examples include pyridoxal phosphate, flavin mononucleotide (FMN), flavin adenine dinucleotide (FAD), thiamin pyrophosphate, lipoic acid, biotin, and transition metals such as Fe, Co, Cu, Mg, Mn, and Zn. Metal ions that participate in redox reactions generally are bound as organometallic complexes such as the prosthetic groups heme or iron–sulfur clusters (see [Chapter 10](#)). Metals also may facilitate the binding and orientation of substrates, the formation of covalent bonds with reaction intermediates (Co^{2+} in coenzyme B₁₂, see [Chapter 44](#)), or by acting as Lewis acids or bases to render substrates more **electrophilic** (electron-poor) or **nucleophilic** (electron-rich), and hence more reactive (see [Chapter 10](#)).

Cofactors Associate Reversibly With Enzymes or Substrates

Cofactors serve functions similar to those of prosthetic groups. The major difference between the two is operational, not chemical. Cofactors bind

weakly and transiently to their cognate enzymes or substrates, forming dissociable complexes. Therefore, unlike associated prosthetic groups, cofactors must be present in the surrounding environment to promote complex formation in order for catalysis to occur. The most common cofactors also are metal ions. Enzymes that require a metal ion cofactor are termed **metal-activated enzymes** to distinguish them from the **metalloenzymes** for which bound metal ions serve as prosthetic groups.

Many Coenzymes, Cofactors, & Prosthetic Groups Are Derivatives of B Vitamins

The water-soluble B vitamins supply important components of numerous coenzymes. **Nicotinamide** is a component of the redox coenzymes NAD and NADP (**Figure 7-2**); **riboflavin** is a component of the redox coenzymes FMN and FAD; **pantothenic acid** is a component of the acyl group carrier **coenzyme A**. As its pyrophosphate **thiamin** participates in the decarboxylation of α -keto acids while folic acid and cobamide coenzymes function in one-carbon metabolism. In addition, several coenzymes contain the adenine, ribose, and phosphoryl moieties of AMP or ADP (**Figure 7-2**).

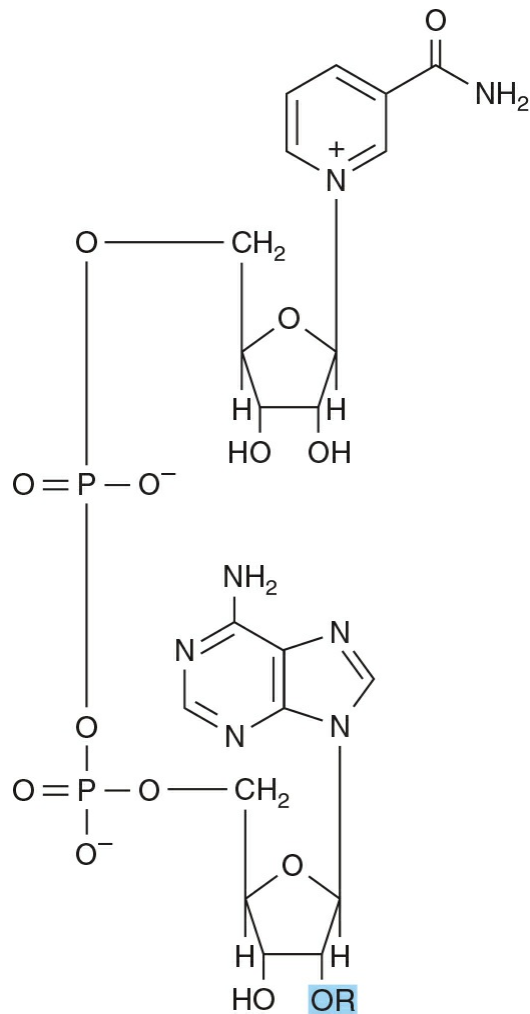

FIGURE 7–2 Structure of NAD⁺ and NADP⁺. For NAD⁺, OR = —OH. For NADP⁺, —OR = —OPO₃²⁻.

Coenzymes Serve as Substrate Shuttles

Coenzymes serve as recyclable shuttles that transport many substrates from one point within the cell to another. The function of these shuttles is twofold. First, they stabilize species such as hydrogen atoms (FADH₂) or hydride ions (NADH) that are too reactive to persist for any significant time in the presence of the water, oxygen, or the organic molecules that permeate cells. Second, they increase the number of points of contact between substrate and enzyme, which increases the affinity and specificity with which small chemical groups such as acetate (coenzyme A), glucose (UDP), or hydride (NAD⁺) are bound by their target enzymes. Other chemical moieties transported by coenzymes include methyl groups (folates) and oligosaccharides (dolichol).

CATALYSIS OCCURS AT THE ACTIVE SITE

An important early 20th-century insight into enzymic catalysis sprang from the observation that the presence of substrates renders enzymes more resistant to the denaturing effects of an elevated temperature. This observation led Emil Fischer to propose that enzymes and their substrates interact to form an enzyme–substrate (ES) complex whose thermal stability is greater than that of the enzyme itself. This insight profoundly shaped our understanding of both the chemical nature and kinetic behavior of enzymic catalysis.

Fischer reasoned that the exquisitely high specificity with which enzymes discriminate their substrates when forming an ES complex was analogous to the manner in which a mechanical lock distinguishes the proper key. The analogy to enzymes is that the “lock” is formed by a cleft or pocket on the surface of the enzyme called the **active site** (see [Figures 5–6](#) and [5–8](#)). As implied by the adjective “active,” the active site is much more than simply a recognition site for binding substrates; it provides the environment wherein chemical transformation takes place. Within the active site, substrates are brought into close proximity with one another in optimal alignment with the cofactors, prosthetic groups, and aminoacyl side chains that participate in catalyzing the transformation of substrates into products ([Figure 7–3](#)). Catalysis is further enhanced by the capacity of the active site to shield substrates from water and generate an environment whose polarity, hydrophobicity, acidity, or alkalinity can differ markedly from that of the surrounding cytoplasm.

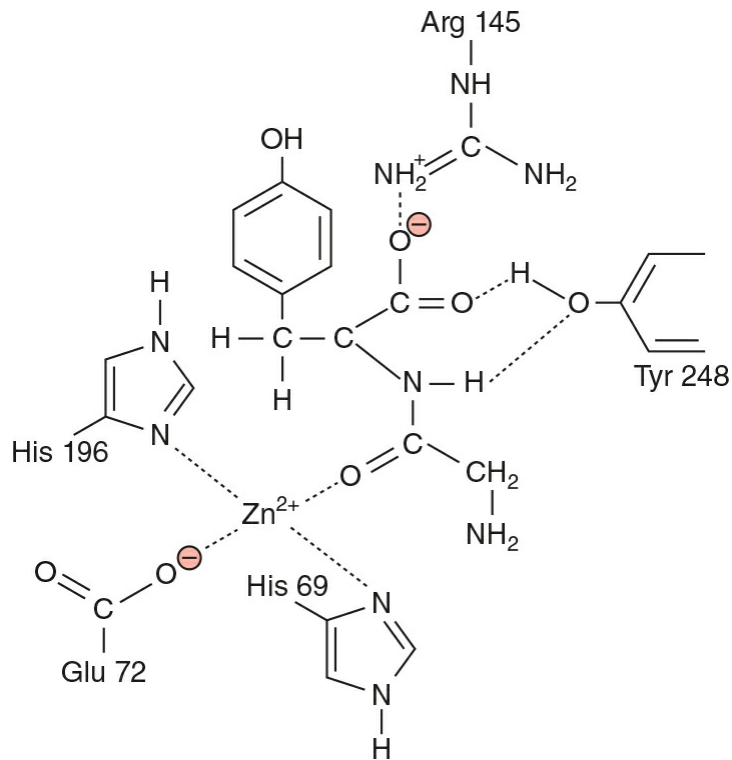

FIGURE 7–3 Two-dimensional representation of a dipeptide substrate, glycyl-tyrosine, bound within the active site of carboxypeptidase A.

ENZYMES EMPLOY MULTIPLE MECHANISMS TO FACILITATE CATALYSIS

Enzymes use combinations of four general mechanisms to achieve dramatic enhancements of the rates of chemical reactions.

Catalysis by Proximity

For molecules to interact, they must come within bond-forming distance of one another. The higher their concentration, the more frequently they will encounter one another, and the greater will be the rate at which they react. When an enzyme binds substrate molecules at its active site, it creates a region of high local substrate concentration in which the substrate molecules are oriented in a position ideal for them to chemically interact. This results in rate enhancements of at least a thousandfold over the same nonenzyme-catalyzed reaction.

Acid–Base Catalysis

In addition to contributing to the ability of the active site to bind substrates, the ionizable functional groups of aminoacyl side chains and, where present, of prosthetic groups, can contribute to catalysis by acting as acids or bases. We distinguish two types of acid–base catalysis. **Specific acid or base catalysis** refers to reactions for which the only *participating* acids or bases are protons or hydroxide ions. The rate of reaction thus is sensitive to changes in the concentration of protons or hydroxide ions, but is *independent* of the concentrations of other acids (proton donors) or bases (proton acceptors) present in the solution or at the active site. Reactions whose rates are responsive to *all* the acids or bases present are said to be subject to **general acid catalysis** or **general base catalysis**.

Catalysis by Strain

For catalysis of lytic reactions, which involve breaking a covalent bond, enzymes typically bind their substrates in a conformation that weakens the bond targeted for cleavage through physical distortion and electronic polarization. This strained conformation mimics that of the **transition state intermediate**, a transient species that represents the midway point in the transformation of substrates to products. Nobel Laureate Linus Pauling was the first to suggest a role for **transition state stabilization** as a general mechanism by which enzymes accelerate the rates of chemical reactions. Knowledge of the transition state of an enzyme-catalyzed reaction is frequently exploited by chemists to design and synthesize more effective enzyme inhibitors, called **transition state analogs**, as potential pharmacophores.

Covalent Catalysis

The process of **covalent catalysis** involves the formation of a covalent bond between the enzyme and one or more substrates. **The modified enzyme thus becomes a reactant**. Covalent catalysis provides a new reaction pathway whose activation energy is lower—and rate of reaction therefore faster—than the pathways available in homogeneous solution. The chemically modified state of the enzyme is, however, transient. Completion of the reaction returns the enzyme to its original, unmodified state. Its role thus remains catalytic. Covalent catalysis is particularly common among enzymes that catalyze **group transfer reactions**. Residues on the enzyme that participate in covalent catalysis generally are cysteine or serine, and occasionally histidine. Covalent catalysis often follows a “ping-pong” mechanism—one in which the first substrate is

bound and its product released prior to the binding of the second substrate (**Figure 7–4**).

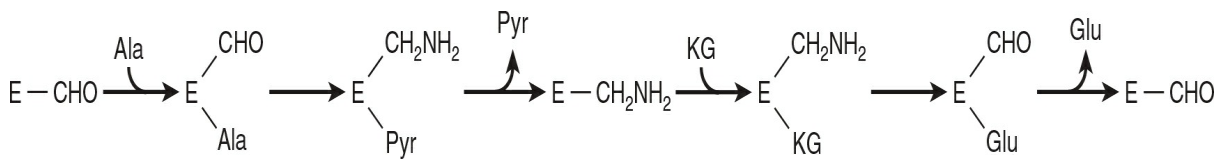

FIGURE 7–4 “Ping-pong” mechanism for transamination. $E-CHO$ and $E-CH_2NH_2$ represent the enzyme-pyridoxal phosphate and enzyme-pyridoxamine complexes, respectively. (Ala, alanine; Glu, glutamate; KG, α -ketoglutarate; Pyr, pyruvate.)

SUBSTRATES INDUCE CONFORMATIONAL CHANGES IN ENZYMES

While Fischer’s “lock and key model” accounted for the exquisite specificity of enzyme–substrate interactions, the implied rigidity of the enzyme’s active site failed to account for the dynamic changes that accompany catalytic transformations. This drawback was addressed by Daniel Koshland’s **induced fit model**, which states that as substrates bind to an enzyme, they induce a conformational change that is analogous to placing a hand (substrate) into a glove (enzyme) (**Figure 7–5**). The enzyme in turn induces reciprocal changes in its substrates, harnessing the energy of binding to facilitate the transformation of substrates into products. The induced fit model has been amply confirmed by biophysical studies of enzyme motion during substrate binding.

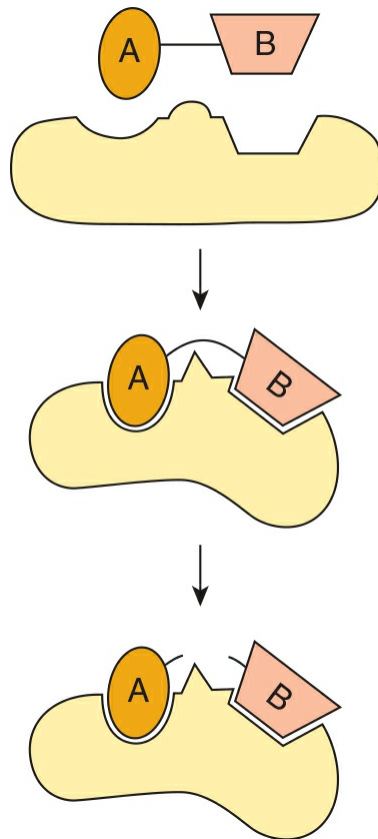

FIGURE 7–5 Two-dimensional representation of Koshland’s induced fit model of the active site of a lyase. Binding of the substrate A—B induces conformational changes in the enzyme that align catalytic residues which participate in catalysis and strain the bond between A and B, facilitating its cleavage.

HIV PROTEASE ILLUSTRATES ACID–BASE CATALYSIS

Enzymes of the **aspartic protease family**, which includes the digestive enzyme pepsin, the lysosomal cathepsins, and the protease produced by the human immunodeficiency virus (HIV), share a common mechanism that employs two conserved aspartyl residues as acid–base catalysts. In the first stage of the reaction, one aspartate functions as a general base (Asp X, **Figure 7–6**) that extracts a proton from a water molecule to make it more nucleophilic. The resulting nucleophile then attacks the electrophilic carbonyl carbon of the peptide bond targeted for hydrolysis, forming a **tetrahedral transition state intermediate**. A second aspartate (Asp Y, **Figure 7–6**) then facilitates the decomposition of this tetrahedral intermediate by donating a proton to the amino group produced by rupture of the peptide bond. The two active site aspartates can act simultaneously

as a general base or as a general acid because their immediate environment favors ionization of one, but not the other.

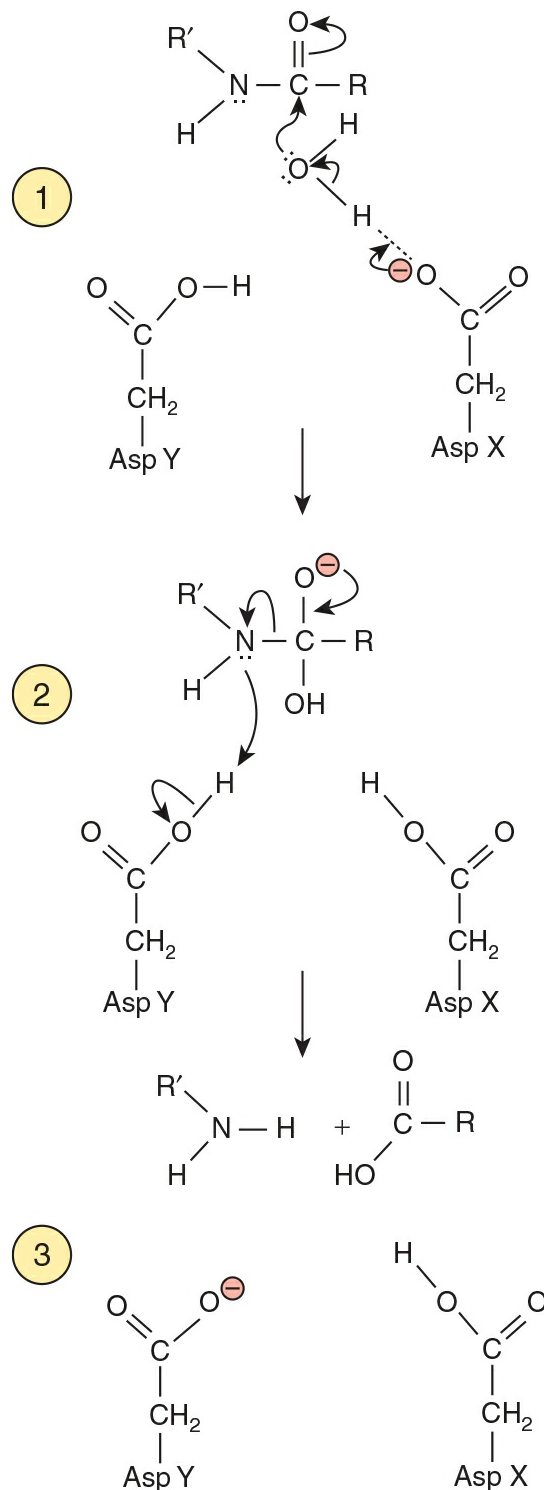

FIGURE 7-6 Mechanism for catalysis by an aspartic protease such as HIV protease. Curved arrows indicate directions of electron movement. ① Aspartate X acts as a base to activate a water molecule by abstracting a proton. ② The activated water molecule attacks the peptide bond, forming

a transient tetrahedral intermediate. ③ Aspartate Y acts as an acid to facilitate breakdown of the tetrahedral intermediate and release of the split products by donating a proton to the newly formed amino group. Subsequent shuttling of the proton on Asp X to Asp Y restores the protease to its initial state.

CHYMOTRYPSIN & FRUCTOSE-2, 6-BISPHOSPHATASE ILLUSTRATE COVALENT CATALYSIS

Chymotrypsin

While catalysis by aspartic proteases involves the direct hydrolytic attack of water on a peptide bond, catalysis by the **serine protease** chymotrypsin involves formation of a covalent acyl-enzyme intermediate. A conserved seryl residue, serine 195, is activated via interactions with histidine 57 and aspartate 102. While these three residues are far apart in primary structure, in the active site of the mature, folded protein they reside within bond-forming distance of one another. Aligned in the order Asp 102-His 57-Ser 195, this trio forms a linked **charge-relay network** that acts as a “**proton shuttle.**”

Binding of substrate initiates proton shifts that in effect transfer the hydroxyl proton of Ser 195 to Asp 102 (**Figure 7-7**). The enhanced nucleophilicity of the seryl oxygen facilitates its attack on the carbonyl carbon of the peptide bond of the substrate, forming a covalent **acyl-enzyme intermediate**. The proton on Asp 102 then shuttles via His 57 to the amino group liberated when the peptide bond is cleaved. The portion of the original peptide with a free amino group then leaves the active site and is replaced by a water molecule. The charge-relay network now activates the water molecule by withdrawing a proton through His 57 to Asp 102. The resulting hydroxide ion attacks the acyl-enzyme intermediate, and a reverse proton shuttle returns a proton to Ser 195, restoring its original state. While modified during the process of catalysis, chymotrypsin emerges unchanged on completion of the reaction. The proteases trypsin and elastase employ a similar catalytic mechanism, but the numbering of the residues in their Ser-His-Asp proton shuttles differ.

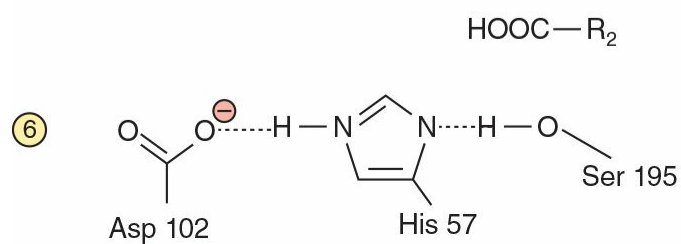
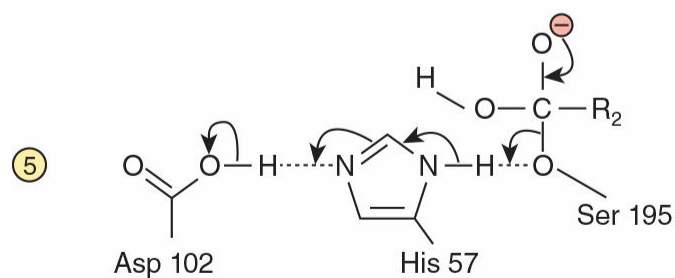
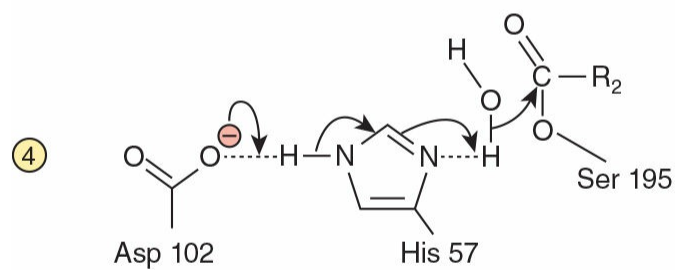
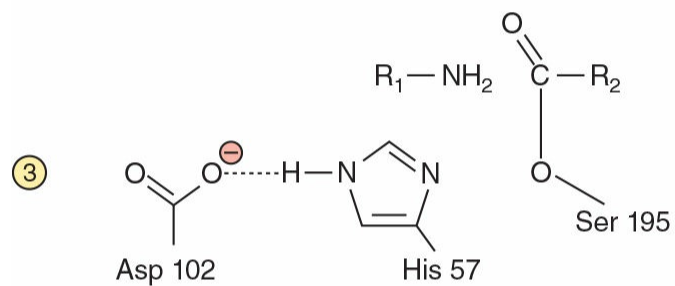
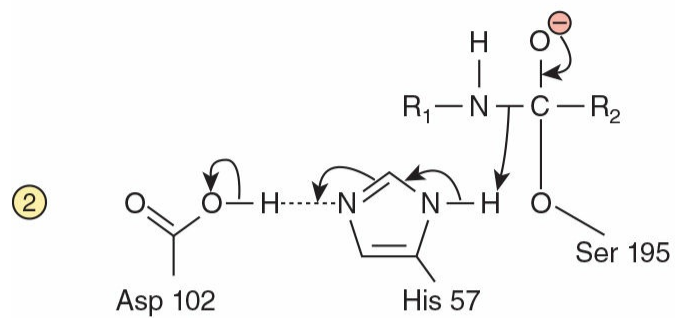
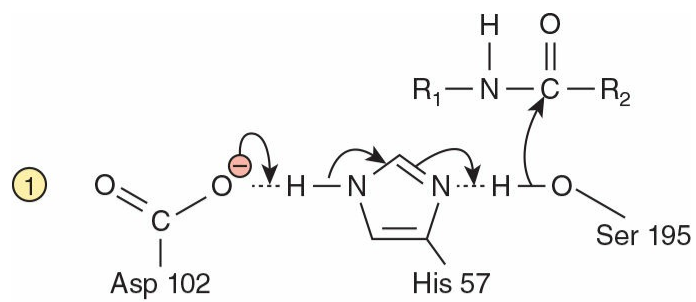

FIGURE 7–7 Catalysis by chymotrypsin. ① The charge-relay system removes a proton from Ser 195, making it a stronger nucleophile. ② Activated Ser 195 attacks the peptide bond, forming a transient tetrahedral intermediate. ③ Release of the amino terminal peptide is facilitated by donation of a proton to the newly formed amino group by His 57 of the charge-relay system, yielding an acyl-Ser 195 intermediate. ④ His 57 and Asp 102 collaborate to activate a water molecule, which attacks the acyl-Ser 195, forming a second tetrahedral intermediate. ⑤ The charge-relay system donates a proton to Ser 195, facilitating breakdown of the tetrahedral intermediate to release the carboxyl terminal peptide ⑥.

Fructose-2,6-Bisphosphatase

Fructose-2,6-bisphosphatase, a regulatory enzyme of gluconeogenesis (see [Chapter 19](#)), catalyzes the hydrolytic release of the phosphate on carbon 2 of fructose-2,6-bisphosphate. **Figure 7–8** illustrates the roles of seven active site residues. Catalysis involves a “catalytic triad” consisting of one Glu and two His residues, of which one His forms a covalent phosphohistidyl intermediate.

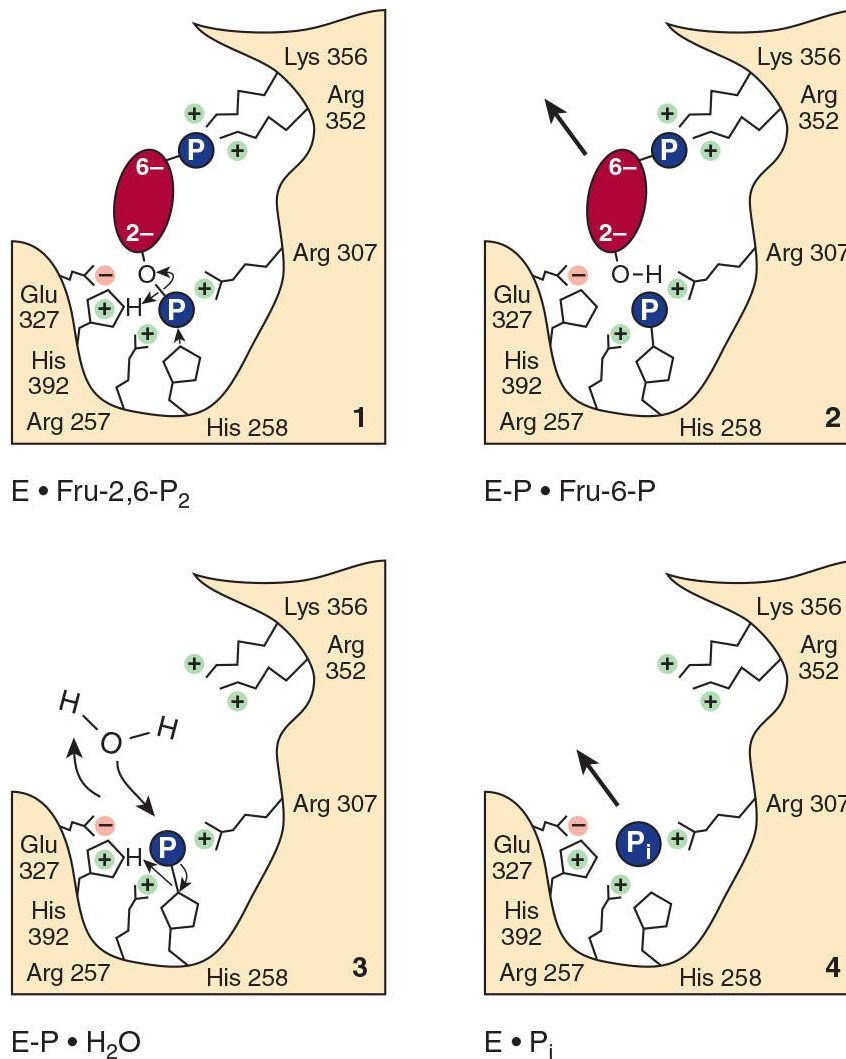

FIGURE 7–8 Catalysis by fructose-2,6-bisphosphatase. (1) Lys 356 and Arg 257, 307, and 352 stabilize the quadruple negative charge of the substrate by charge–charge interactions. Glu 327 stabilizes the positive charge on His 392. (2) The nucleophile His 392 attacks the C-2 phosphoryl group and transfers it to His 258, forming a phosphoryl-enzyme intermediate. Fructose-6-phosphate now leaves the enzyme. (3) Nucleophilic attack by a water molecule, possibly assisted by Glu 327 acting as a base, forms inorganic phosphate. (4) Inorganic orthophosphate is released from Arg 257 and Arg 307. (Reproduced, with permission, from Pilkis SJ, et al: 6-Phosphofructo-2-kinase/fructose-2,6-bisphosphatase: a metabolic signaling enzyme. *Annu Rev Biochem* 1995;64:799. © 1995 by Annual Reviews, www.annualreviews.org.)

CATALYTIC RESIDUES ARE HIGHLY CONSERVED

Members of an enzyme family such as the aspartic or serine proteases employ a similar mechanism to catalyze a common reaction type, but act on different substrates. Most enzyme families appear to have arisen through gene duplication events that created a second copy of the gene that encodes a particular enzyme. The two genes, and consequently their encoded proteins, can then evolve independently, forming divergent **homologs** that recognize different substrates. The result is illustrated by chymotrypsin, which cleaves peptide bonds on the carboxyl terminal side of large hydrophobic amino acids, and trypsin, which cleaves peptide bonds on the carboxyl terminal side of basic amino acids. Proteins that diverged from a common ancestor are said to be **homologous** to one another. The common ancestry of enzymes can be inferred from the presence of specific amino acids in the same relative position in each family member. These residues are said to be **evolutionarily conserved**.

ISOZYMES ARE DISTINCT ENZYME FORMS THAT CATALYZE THE SAME REACTION

Higher organisms often elaborate several physically distinct versions of a given enzyme, each of which catalyzes the same reaction. Like the members of other protein families, these protein catalysts or **isozymes** arise through gene duplication. While the homologous proteases described act on different substrates, isozymes differ in auxiliary features such as sensitivity to particular regulatory factors (see [Chapter 9](#)) or subcellular location that adapt them to specific tissues or circumstances rather than distinct substrates. Isozymes that catalyze the identical reaction may also enhance survival by providing a “backup” copy of an essential enzyme.

THE CATALYTIC ACTIVITY OF ENZYMES FACILITATES THEIR DETECTION

The relatively small quantities of enzymes typically contained in cells hamper determination of their presence and abundance. However, the ability to rapidly transform thousands of molecules of a specific substrate into products imbues each enzyme with the ability to amplify its presence. Under appropriate conditions (see [Chapter 8](#)), the rate of the catalytic reaction being monitored is proportionate to the amount of enzyme present, which allows its concentration to be inferred. Assays of the catalytic activity of enzymes are frequently used both in research and clinical laboratories.

Single-Molecule Enzymology

The limited sensitivity of traditional enzyme assays necessitates the use of a large group, or ensemble, of enzyme molecules in order to produce measurable quantities of product. The data obtained thus reflects the *average* activity of individual enzymes across multiple cycles of catalysis. Recent advances in **nanotechnology** and imaging have made it possible to observe catalytic events involving discrete enzyme and substrate molecules. Consequently, scientists can now measure the rate of individual catalytic events, and sometimes a specific step in catalysis, by a process called **single-molecule enzymology**, an example of which is illustrated in **Figure 7–9**.

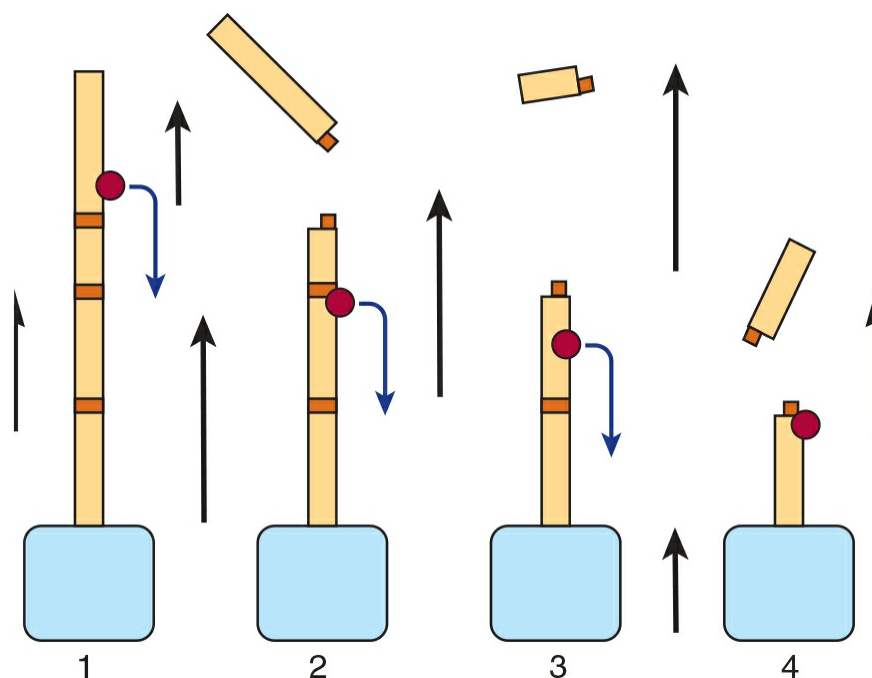

FIGURE 7–9 Direct observation of single DNA cleavage events catalyzed by a restriction endonuclease. DNA molecules immobilized to beads (blue) are placed in a flowing stream of buffer (black arrows), which causes them to assume an extended conformation. Cleavage at one of the restriction sites (orange) by an endonuclease leads to a shortening of the DNA molecule, which can be observed directly in a microscope since the nucleotide bases in DNA are fluorescent. Although the endonuclease (red) does not fluoresce, and hence is invisible, the progressive manner in which the DNA molecule is shortened (1 → 4) reveals that the endonuclease binds to the free end of the DNA molecule and moves along it from site to site.

Drug Discovery Requires Enzyme Assays Suitable for

High-Throughput Screening

Enzymes are frequent targets for the development of drugs and other therapeutic agents. These generally take the form of enzyme inhibitors (see [Chapter 8](#)). The discovery of new drugs is greatly facilitated when a large number of potential pharmacophores can be simultaneously assayed in a rapid, automated fashion—a process referred to as **high-throughput screening (HTS)**. HTS employs robotics, optics, data processing, and microfluidics to simultaneously conduct and monitor thousands of parallel enzyme assays. HTS devices employ 4 to 100 μL volumes in 96, 384, or 1536 well plastic plates using industrial robots to dispense substrates, coenzymes, enzymes, and potential inhibitors in a multiplicity of combinations and concentrations. HTS provides a perfect complement to **combinatorial chemistry**, a method for generating large libraries of chemical compounds spanning all possible combinations of a given set of chemical precursors. Enzyme assays that produce a chromogenic or fluorescent product are ideal since optical detectors can readily monitor multiple samples.

Enzyme-Linked Immunoassays

The sensitivity of enzyme assays can be exploited to detect proteins that lack catalytic activity. **Enzyme-linked immunosorbent assays (ELISAs)** use antibodies covalently linked to a “reporter enzyme” such as alkaline phosphatase or horseradish peroxidase whose products are readily detected, generally by the absorbance of light or by fluorescence. Serum or other biologic samples to be tested are placed in plastic, multiwell microtiter plates, where the proteins adhere to the plastic surface and are immobilized. Any exposed plastic that remains is subsequently “blocked” by adding a nonantigenic protein such as bovine serum albumin. A solution of antibody covalently linked to a reporter enzyme is then added. The antibodies adhere to the immobilized antigen and are themselves immobilized. Excess free antibody molecules are then removed by washing. The presence and quantity of bound antibody is then determined by adding the substrate for the reporter enzyme, and measuring the rate of its conversion to product.

NAD(P)⁺-Dependent Dehydrogenases Are Assayed Spectrophotometrically

The physicochemical properties of the reactants in an enzyme-catalyzed reaction dictate the options for the assay of enzyme activity. Spectrophotometric assays exploit the ability of a substrate or product to absorb light. The reduced coenzymes NADH and NADPH, written as NAD(P)H, absorb light at a wavelength of 340 nm, whereas their oxidized forms NAD(P)⁺ do not (**Figure 7–10**). When NAD(P)⁺ is reduced, the absorbance at 340 nm therefore increases in proportion to—and at a rate determined by—the quantity of NAD(P)H produced. Conversely, when a dehydrogenase catalyzes the oxidation of NAD(P)H, a decrease in absorbance at 340 nm will be observed. In each case, the rate of change in absorbance at 340 nm will be proportionate to the quantity of the enzyme present.

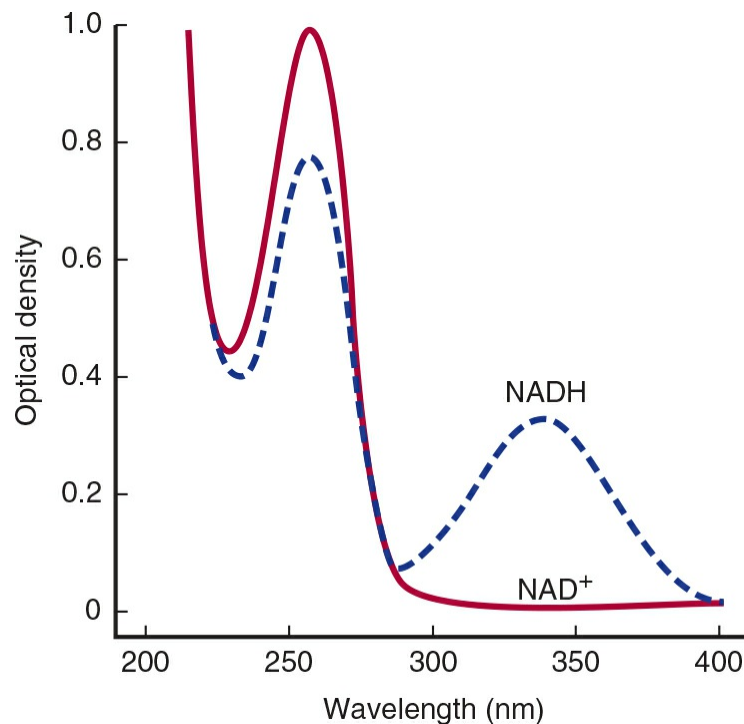

FIGURE 7–10 Absorption spectra of NAD⁺ and NADH. Densities are for a 44-mg/L solution in a cell with a 1-cm light path. NADP⁺ and NADPH have spectra analogous to NAD⁺ and NADH, respectively.

The assay of enzymes whose reactions are not accompanied by a change in absorbance or fluorescence is generally more difficult. In some instances, either the product or remaining substrate can be transformed into a more readily detected compound, although the reaction product may have to be separated from unreacted substrate prior to measurement. An alternative strategy is to devise a synthetic substrate whose product

absorbs light or fluoresces. For example, hydrolysis of the phosphoester bond in *p*-nitrophenyl phosphate (*p*NPP), an artificial substrate molecule, is catalyzed at a measurable rate by numerous phosphatases, phosphodiesterases, and serine proteases. While *p*NPP does not absorb visible light, the anionic form of the *p*-nitrophenol (pK_a 6.7) generated upon its hydrolysis strongly absorbs light at 419 nm, and thus can be quantified.

Many Enzymes May Be Assayed by Coupling to a Dehydrogenase

Another quite general approach is to employ a “coupled” assay (**Figure 7–11**). Typically, a dehydrogenase whose substrate is the product of the enzyme of interest is added in catalytic excess. The rate of appearance or disappearance of NAD(P)H then depends on the rate of the enzyme reaction to which the dehydrogenase has been coupled.

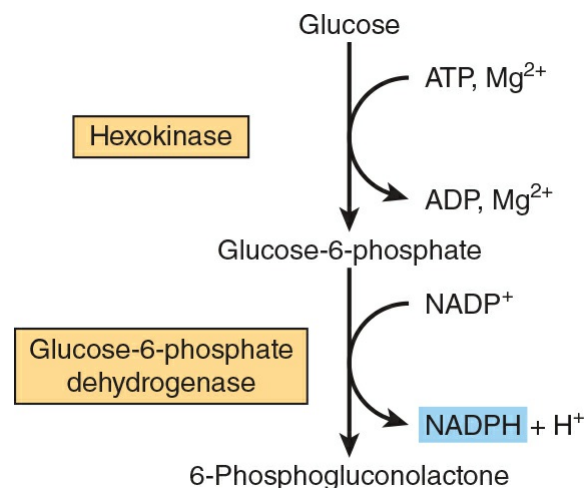

FIGURE 7–11 Coupled enzyme assay for hexokinase activity. The production of glucose-6-phosphate by hexokinase is coupled to the oxidation of this product by glucose-6-phosphate dehydrogenase in the presence of added enzyme and $NADP^+$. When an excess of glucose-6-phosphate dehydrogenase is present, the rate of formation of NADPH, which can be measured at 340 nm, is governed by the rate of formation of glucose-6-phosphate by hexokinase.

THE ANALYSIS OF CERTAIN ENZYMES AIDS DIAGNOSIS

The analysis of enzymes in blood plasma has played a central role in the diagnosis of several disease processes. Many enzymes are functional constituents of blood. Examples include pseudocholinesterase, lipoprotein lipase, and components of the cascades that trigger blood clotting, clot dissolution, and opsonization of invading microbes. Several enzymes are released into plasma following cell death or injury. While these latter enzymes perform no physiologic function in plasma, they can serve as **biomarkers**, molecules whose appearance or levels can assist in the diagnosis and prognosis of diseases and injuries affecting specific tissues. The plasma concentration of an enzyme or other protein released consequent to injury may rise early or late, and may decline rapidly or slowly. Cytoplasmic proteins tend to appear more rapidly than those from subcellular organelles. The speed with which enzymes and other proteins are removed from plasma depends in part upon their susceptibility to proteolysis.

Quantitative analysis of the activity of released enzymes or other proteins, typically in plasma or serum but also in urine or various cells, provides information concerning diagnosis, prognosis, and response to treatment. Assays of enzyme *activity* typically employ standard kinetic assays of initial reaction rates. **Table 7–1** lists several enzymes of value in clinical diagnosis. Note that these enzymes are not absolutely specific for the indicated disease. For example, elevated blood levels of prostatic acid phosphatase are associated typically with prostate cancer, but also may occur with certain other cancers and noncancerous conditions. Interpretation of enzyme assay data must make due allowance for the sensitivity and the diagnostic specificity of the enzyme test, together with other factors elicited through a comprehensive clinical examination that includes patient's age, sex, prior history, and possible drug use.

TABLE 7–1 Principal Serum Enzymes Used in Clinical Diagnosis

Serum Enzyme	Major Diagnostic Use
Alanine aminotransferase (ALT)	Viral hepatitis
Amylase	Acute pancreatitis
Ceruloplasmin	Hepatolenticular degeneration (Wilson disease)
Creatine kinase	Muscle disorders
γ -Glutamyl transferase	Various liver diseases
Lactate dehydrogenase isozyme 5	Liver diseases
Lipase	Acute pancreatitis
β -Glucocerebrosidase	Gaucher disease
Phosphatase, alkaline (isozymes)	Various bone disorders, obstructive liver diseases

ALT, alanine aminotransferase.

Note: Many of the above enzymes are not specific to the disease listed.

Analysis of Serum Enzymes Following Tissue Injury

An enzyme useful for diagnostic enzymology should be relatively specific for the tissue or organ under study, and should appear in the plasma or other fluid at a time useful for diagnosis (the “diagnostic window”). In the case of a myocardial infarction (MI), detection must be possible within a few hours of a preliminary diagnosis to permit initiation of appropriate therapy. The first enzymes used to diagnose MI were aspartate aminotransferase (AST), alanine aminotransferase (ALT), and lactate dehydrogenase (LDH). Diagnosis using LDH exploits the tissue-specific variations in its quaternary structure (**Figure 7–12**). However, it is released relatively slowly following injury. Creatine kinase (CK) has three tissue-specific isozymes: CK-MM (skeletal muscle), CK-BB (brain), and CK-MB (heart and skeletal muscle), along with a more optimal diagnostic window. As with LDH, individual CK isozymes are separable by electrophoresis. Assay of plasma CK levels presently continues in use to assess skeletal muscle disorders such as Duchene muscular dystrophy.

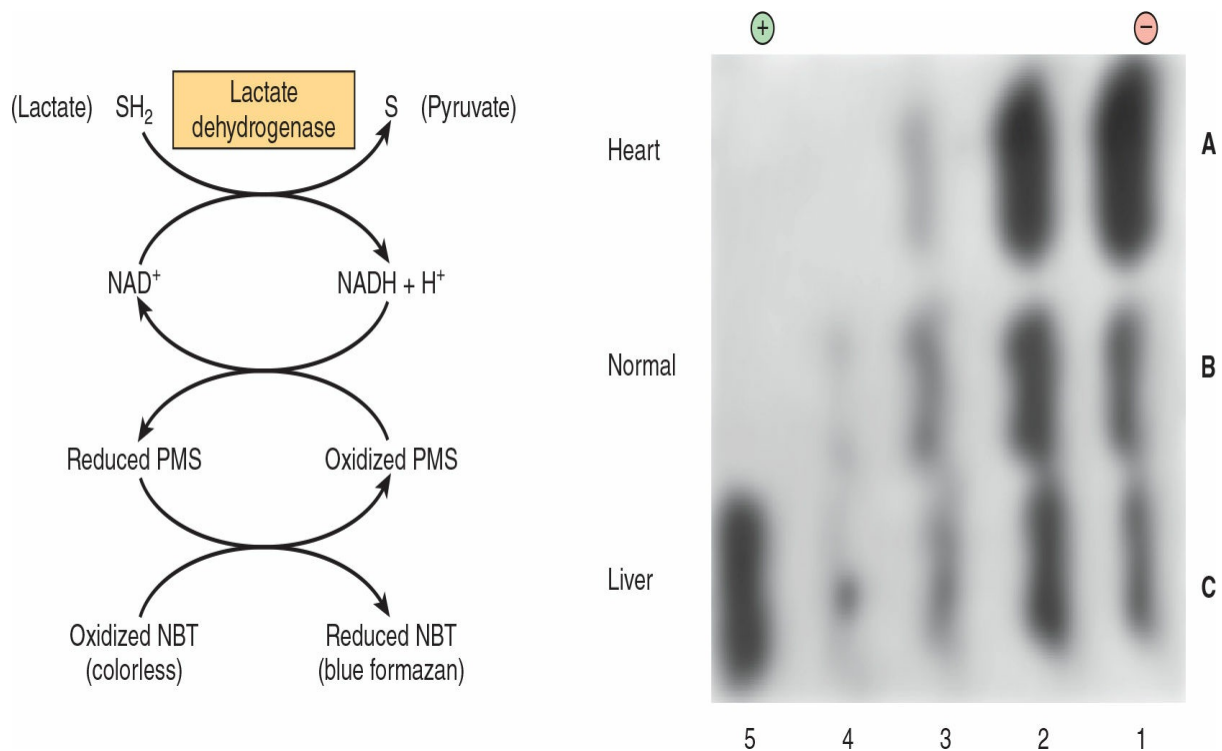

FIGURE 7–12 Normal and pathologic patterns of lactate dehydrogenase (LDH) isozymes in human serum. Samples of serum were separated by electrophoresis. LDH isozymes were then visualized using a dye-coupled reaction-specific for LDH. Pattern **A** is serum from a patient with a myocardial infarct; **B** is normal serum; and **C** is serum from a patient with liver disease. Arabic numerals identify LDH isozymes 1 through 5. Electrophoresis and a specific detection technique thus can be used to visualize isozymes of enzymes other than LDH.

Plasma Troponin Constitutes the Currently Preferred Diagnostic Marker for an MI

Troponin is a complex of three proteins present in the contractile apparatus of *skeletal* and *cardiac muscle* but not in *smooth muscle* (see [Chapter 51](#)). Troponin levels rise for 2 to 6 hours after an MI, and remain elevated for 4 to 10 days. Immunological measurements of plasma levels of cardiac troponins I and T thus provide sensitive and specific indicators of damage to heart muscle. Since other sources of heart muscle damage also elevate serum troponin levels, cardiac troponins thus provide a general marker of cardiac injury.

Additional Clinical Uses of Enzymes

Enzymes are employed in the clinical laboratory to determine the presence and the concentration of critical metabolites. For example, glucose oxidase frequently is utilized to measure plasma glucose concentration. Enzymes also are employed with increasing frequency for the treatment of injury and disease. Examples include tissue plasminogen activator (tPA) or streptokinase for treatment of acute MI, and trypsin for treatment of cystic fibrosis. Intravenous infusion of recombinantly produced glycosylases can be used to treat lysosomal storage syndromes such as Gaucher disease (β -glucosidase), Pompe disease (α -glucosidase), Fabry disease (α -galactosidase A), and Sly disease (β -glucuronidase).

ENZYMES FACILITATE DIAGNOSIS OF GENETIC AND INFECTIOUS DISEASES

Many diagnostic techniques take advantage of the specificity and efficiency of the enzymes that act on oligonucleotides such as DNA. Enzymes known as **restriction endonucleases**, for example, cleave double-stranded DNA at sites specified by a sequence of four, six, or more base pairs called **restriction sites**. Cleavage of a sample of DNA with a restriction enzyme produces a characteristic set of smaller DNA fragments (see [Chapter 39](#)). Deviations in the normal product pattern, called **restriction fragment length polymorphisms (RFLPs)**, occur if a mutation renders a restriction site unrecognizable to its cognate restriction endonuclease or, alternatively, generates a new recognition site. RFLPs are currently utilized to facilitate prenatal detection of a number of hereditary disorders, including sickle cell trait, β -thalassemia, infant phenylketonuria, and Huntington disease.

Medical Applications of the Polymerase Chain Reaction

As described in [Chapter 39](#), the **polymerase chain reaction (PCR)** employs a thermostable DNA polymerase and appropriate oligonucleotide primers to produce thousands of copies of a defined segment of DNA from a minute quantity of starting material. PCR enables medical, biological, and forensic scientists to detect and characterize DNA present initially at levels too low for direct detection. In addition to screening for genetic mutations, PCR can be used to detect pathogens and parasites such as *Trypanosoma cruzi*, the causative agent of Chagas disease, and *Neisseria meningitidis*, the causative agent of bacterial meningitis, through the

selective amplification of their DNA.

RECOMBINANT DNA PROVIDES AN IMPORTANT TOOL FOR STUDYING ENZYMES

Highly purified samples of enzymes are essential for the study of their structure and function. The isolation of an individual enzyme, particularly one present in low concentration, from among the thousands of proteins present in a cell can be extremely difficult. By cloning the gene for the enzyme of interest, it generally is possible to produce large quantities of its encoded protein in *Escherichia coli* or yeast. However, not all animal proteins can be expressed in their appropriately folded, functionally competent form in microbial cells as these organisms cannot perform certain posttranslational processing tasks specific to higher organisms. In these instances, options include expression of recombinant genes in cultured animal cell systems or by employing the baculovirus expression vector of cultured insect cells. For more details concerning recombinant DNA techniques, see [Chapter 39](#).

Recombinant Fusion Proteins Are Purified by Affinity Chromatography

Recombinant DNA technology can also be used to generate proteins specifically modified to render them readily purified by affinity chromatography. The gene of interest is linked to an additional oligonucleotide sequence that encodes a carboxyl or amino terminal extension to the protein of interest. The resulting **fusion protein** contains a new domain tailored to interact with an appropriately modified affinity support. One popular approach is to attach an oligonucleotide that encodes six consecutive histidine residues. The expressed “His tag” protein binds to chromatographic supports that contain an immobilized divalent metal ion such as Ni^{2+} or Cd^{2+} . This approach exploits the ability of these divalent cations to bind His residues. Once bound, contaminating proteins are washed off and the His-tagged enzyme is eluted with buffers containing high concentrations of free histidine or imidazole, which compete with the polyhistidine tails for binding to the immobilized metal ions. Alternatively, the substrate-binding domain of glutathione S-transferase (GST) can serve as a “GST tag.” [Figure 7–13](#) illustrates the purification of a GST-fusion protein using an affinity support containing bound glutathione.

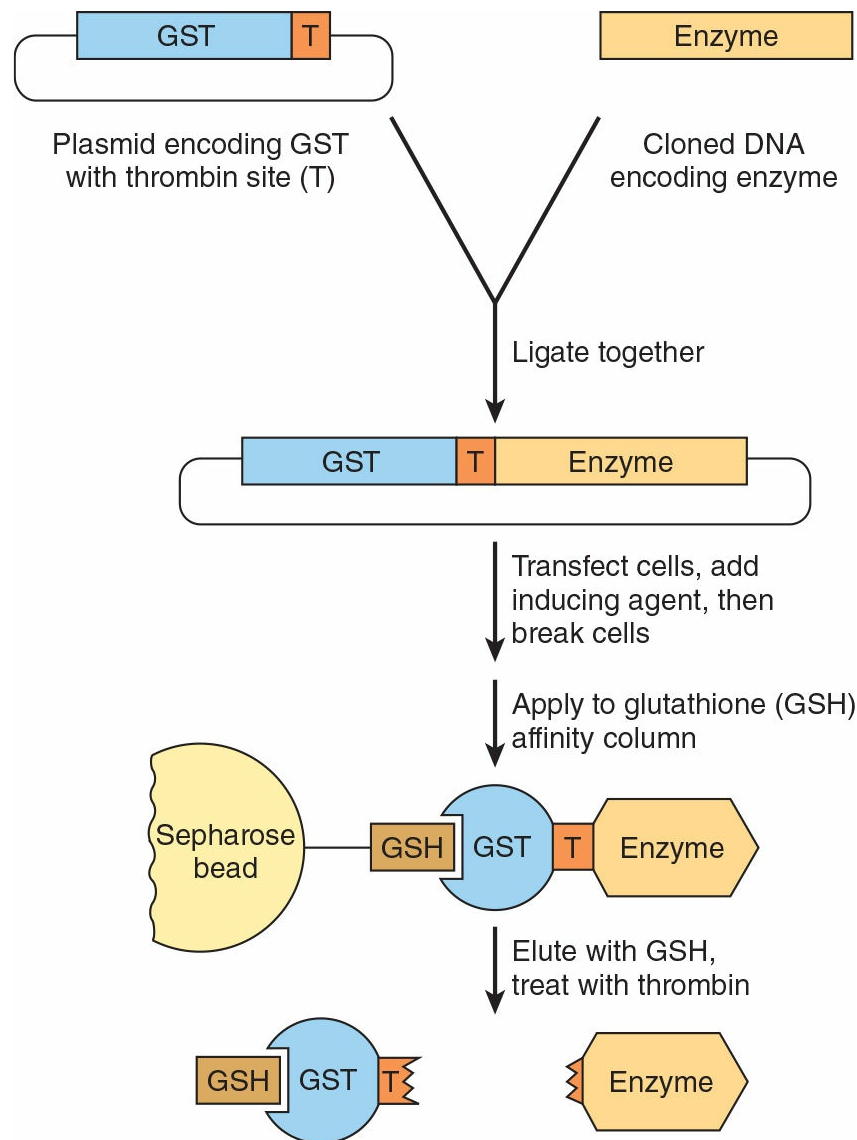

FIGURE 7–13 Use of glutathione S-transferase (GST) fusion proteins to purify recombinant proteins. (GSH, glutathione.)

The addition of an N-terminal fusion domain may also help induce proper folding of the remainder of the recombinant polypeptide. Most fusion domains also possess a cleavage site for a highly specific protease such as thrombin in the region that links the two portions of the protein to permit its eventual removal.

Site-Directed Mutagenesis Provides Mechanistic Insights

Once the ability to express a protein from its cloned gene has been established, it is possible to employ **site-directed mutagenesis** to change specific aminoacyl residues by altering their codons. Used in combination

with kinetic analyses and x-ray crystallography, this approach facilitates identification of the specific roles of given aminoacyl residues in substrate binding and catalysis. For example, the inference that a particular aminoacyl residue functions as a general acid can be tested by replacing it with an aminoacyl residue incapable of donating a proton.

RIBOZYMES: ARTIFACTS FROM THE RNA WORLD

Cech Discovered the First Catalytic RNA Molecule

The participation of enzyme catalysts in the posttranslational maturation of certain proteins has analogies in the RNA world. Many RNA molecules undergo processing reactions that remove segments of oligonucleotide and religate the remaining segments to form the mature polynucleotide product (see [Chapter 36](#)). Not all of these catalysts are proteins, however. While examining the processing of ribosomal RNA (rRNA) molecules in the ciliated protozoan *Tetrahymena* in the early 1980s, Thomas Cech and his coworkers observed that processing of the 26S rRNA proceeded smoothly *in vitro* even in the total *absence* of protein. The source of this splicing activity was traced to a 413 bp catalytic segment that retained its catalytic activity even when replicated in *Escherichia coli* (see [Chapter 39](#)). Prior to that time, it had been thought that polynucleotides served solely as information storage and transmission entities, and that catalysis was restricted solely to proteins.

Several other ribozymes have since been discovered. The vast majority catalyze nucleophilic displacement reactions that target the phosphodiester bonds of the RNA backbone. In small self-cleaving RNAs, such as hammerhead or hepatitis delta virus RNA, the attacking nucleophile is water and the result is hydrolysis. For the large group I intron ribozymes, the attacking nucleophile is the 3'-hydroxyl of the terminal ribose of another segment of RNA and the result is a splicing reaction.

The Ribosome—The Ultimate Ribozyme

The ribosome was the first example of a “molecular machine” to be recognized. A massive complex comprised of scores of protein subunits and several large ribosomal RNA molecules, the ribosome performs the vitally important and highly complex process of synthesizing long polypeptide chains following the instructions encoded in messenger RNA (mRNA) molecules (see [Chapter 37](#)). For many years, it was assumed that

rRNAs played a passive, structural role, or perhaps assisted in the recognition of cognate mRNAs through a base pairing mechanism. It was thus somewhat surprising when it was discovered that rRNAs were both necessary and sufficient for catalyzing peptide synthesis.

The RNA World Hypothesis

The discovery of ribozymes has had a profound influence on evolutionary theory. For many years, scientists had hypothesized that the first biologic catalysts were formed when amino acids contained in the primordial soup coalesced to form simple proteins. With the realization that RNA could both carry information and catalyze chemical reactions, a new “RNA World” hypothesis emerged in which RNA constituted the first biologic macromolecule. Eventually, a more chemically stable oligonucleotide, DNA, superseded RNA for long-term information storage, while proteins, by virtue of their greater chemical functional group and conformational diversity dominated catalysis. If one assumes that some sort of RNA-protein hybrid was formed as an intermediate in the transition from ribonucleotide to polypeptide catalysts, one needs to look no further than the ribosome to find the presumed missing link.

Why did not proteins take over all catalytic functions? Presumably, in the case of the ribosome the process was both too complex and too essential to permit much opportunity for possible competitors to gain a foothold. In the case of the small self-cleaving RNAs and self-splicing introns, they may represent one of the few cases in which RNA autocatalysis is more efficient than development of a new protein catalyst.

SUMMARY

- Enzymes are efficient catalysts whose stringent specificity extends to the kind of reaction catalyzed, and typically, to a single substrate.
- Organic and inorganic prosthetic groups, cofactors, and coenzymes play important roles in catalysis. Coenzymes, many of which are derivatives of B vitamins, serve as “shuttles” for commonly used groups such as amines, electrons, and acetyl groups.
- During catalysis, enzymes redirect the conformational changes induced by substrate binding to effect complementary changes that facilitate transformation into product.
- Catalytic mechanisms employed by enzymes include the introduction of strain, approximation of reactants, acid–base catalysis, and covalent

catalysis. HIV protease illustrates acid–base catalysis; chymotrypsin and fructose-2,6-bisphosphatase illustrate covalent catalysis.

- Aminoacyl residues that participate in catalysis are highly conserved through the evolution of enzymes. Site-directed mutagenesis, used to change residues suspected of being important in catalysis or substrate binding, provides insights into mechanisms of enzyme action.
- The catalytic activity of enzymes reveals their presence, facilitates their detection, and provides the basis for enzyme-linked immunoassays. Many enzymes can be assayed spectrophotometrically by coupling them to an NAD(P)⁺-dependent dehydrogenase.
- Combinatorial chemistry generates extensive libraries of potential enzyme activators and inhibitors that can be tested by HTS.
- Assay of plasma enzymes aids diagnosis and prognosis of acute pancreatitis and of various bone and liver disorders. Serum enzymes have, however, been replaced by assay of plasma troponins as diagnostic of a myocardial infarction.
- Restriction endonucleases facilitate diagnosis of genetic diseases by revealing restriction fragment length polymorphisms.
- The PCR amplifies DNA initially present in quantities too small for analysis.
- Attachment of a polyhistidyl, GST, or other “tag” to the N- or C-terminus of a recombinant protein facilitates its purification by affinity chromatography on a solid support that contains an immobilized ligand such as a divalent cation (eg, Ni²⁺) or glutathione. Specific proteases can then remove affinity “tags” and generate the native enzyme.
- Not all enzymes are proteins. Several ribozymes are known that can cut and resplice the phosphodiester bonds of RNA. In the ribosome, it is the rRNA and not the polypeptide components that are primarily responsible for catalysis.

REFERENCES

- Apple FS, Sandoval Y, Jaffe AS, et al: Cardiac troponin assays: guide to understanding analytical characteristics and their impact on clinical care. *Clin Chem* 2017;63:73.
- de la Peña M, García-Robles I, Cervera A: The hammerhead ribozyme: a long history for a short RNA. *Molecules* 2017;22:78.
- Frey PA, Hegeman AD: *Enzyme Reaction Mechanisms*. Oxford University

- Press, 2006.
- Gupta S, de Lemos JA: Use and misuse of cardiac troponins in clinical practice. *Prog Cardiovasc Dis* 2007;50:151.
- Hedstrom L: Serine protease mechanism and specificity. *Chem Rev* 2002;102:4501.
- Knight AE: Single enzyme studies: a historical perspective. *Meth Mol Biol* 2011;778:1.
- Melanson SF, Tanasijevic MJ: Laboratory diagnosis of acute myocardial injury. *Cardiovasc Pathol* 2005;14:156.
- Rho JH, Lampe PD: High-throughput analysis of plasma hybrid markers for early detection of cancers. *Proteomes* 2014;2:1.
- Sun B, Wang MD: Single-hyphen molecule optical-trapping techniques to study molecular mechanisms of a replisome. *Methods Enzymol* 2017;582:55.

Enzymes: Kinetics

Victor W. Rodwell, PhD

OBJECTIVES

After studying this chapter, you should be able to:

- Describe the scope and objectives of enzyme kinetic analysis.
- Indicate whether ΔG , the overall change in free energy for a reaction, is dependent on reaction mechanism.
- Indicate whether ΔG is a function of the *rates* of reactions.
- Explain the relationship between K_{eq} , concentrations of substrates and products at equilibrium, and the ratio of the rate constants k_1/k_{-1} .
- Outline how the concentration of hydrogen ions, of enzyme, and of substrate affect the rate of an enzyme-catalyzed reaction.
- Utilize collision theory to explain how temperature affects the rate of a chemical reaction.
- Define initial rate conditions and explain the advantage obtained from measuring the velocity of an enzyme-catalyzed reaction under these conditions.
- Describe the application of linear forms of the Michaelis-Menten equation to estimate K_m and V_{max} .

- Give one reason why a linear form of the Hill equation is used to evaluate how substrate-binding influences the kinetic behavior of certain multimeric enzymes.
- Contrast the effects of an increasing concentration of substrate on the kinetics of simple competitive and noncompetitive inhibition.
- Describe how substrates add to, and products depart from, an enzyme that follows a ping-pong mechanism.
- Describe how substrates add to, and products depart from, an enzyme that follows a rapid-equilibrium mechanism.
- Provide examples of the utility of enzyme kinetics in ascertaining the mode of action of drugs.

BIOMEDICAL IMPORTANCE

A complete and balanced set of enzyme activities is required for maintaining homeostasis. Enzyme kinetics, the quantitative measurement of the rates of enzyme-catalyzed reactions and the systematic study of factors that affect these rates, constitutes a central tool for the analysis, diagnosis, and treatment of the enzymic imbalances that underlie numerous human diseases. For example, kinetic analysis can reveal the number and order of the individual steps by which enzymes transform substrates into products, and in conjunction with site-directed mutagenesis, kinetic analyses can reveal details of the catalytic mechanism of a given enzyme. In the blood, the appearance or a surge in the levels of particular enzymes serves as clinical indicators for pathologies such as myocardial infarctions, prostate cancer, and damage to the liver. The involvement of enzymes in virtually all physiologic processes makes them the targets of choice for drugs that cure or ameliorate human disease. Applied enzyme kinetics represents the principal tool by which scientists identify and characterize therapeutic agents that selectively inhibit the rates of specific enzyme-catalyzed processes. Enzyme kinetics thus plays a central and critical role in drug discovery, in comparative to pharmacodynamics, and in elucidating the mode of action of drugs.

CHEMICAL REACTIONS ARE DESCRIBED USING BALANCED EQUATIONS

A **balanced chemical equation** lists the initial chemical species (substrates) present and the new chemical species (products) formed for a

particular chemical reaction, all in their respective proportions or **stoichiometry**. For example, balanced [equation \(1\)](#) indicates that one molecule each of substrates A and B reacts to form one molecule each of products P and Q:



The double arrows indicate reversibility, an intrinsic property of all chemical reactions. Thus, for reaction (1), if A and B can form P and Q, then P and Q can also form A and B. Designation of a particular reactant as a “substrate” or “product” is therefore somewhat arbitrary since the products for a reaction written in one direction are the substrates for the reverse reaction. The term “products” is, however, often used to designate the reactants whose formation is thermodynamically favored. Reactions for which thermodynamic factors strongly favor formation of the products to which the arrow points often are represented with a single arrow as if they were “irreversible”:



Unidirectional arrows are also used to describe reactions in living cells where the products of reaction (2) are immediately consumed by a subsequent enzyme-catalyzed reaction or rapidly escape the cell, for example, CO₂. The rapid removal of product P or Q therefore effectively precludes occurrence of the reverse reaction, rendering [equation \(2\)](#) **functionally irreversible under physiologic conditions**.

CHANGES IN FREE ENERGY DETERMINE THE DIRECTION & EQUILIBRIUM STATE OF CHEMICAL REACTIONS

The Gibbs free-energy change ΔG (also called either free energy or Gibbs energy) describes in quantitative form both the *direction* in which a chemical reaction will tend to proceed and the concentrations of reactants and products that will be present at equilibrium. ΔG for a chemical reaction equals the sum of the free energies of formation of the reaction products ΔG_p minus the sum of the free energies of formation of the substrates ΔG_s . A similar but different quantity designated by ΔG^0 denotes the change in free energy that accompanies transition from the standard state, one-molar concentrations of substrates and products, to equilibrium. A more useful biochemical term is $\Delta G^0'$, which defines ΔG^0

at a standard state of 10^{-7} M protons, pH 7.0. If the free energy of formation of the products is *lower* than that of the substrates, the signs of ΔG^0 and $\Delta G^{0'}$ will be *negative*, indicating that the reaction as written is favored in the direction left to right. Such reactions are referred to as **spontaneous**. The **sign** and the **magnitude** of the free-energy change determine how far the reaction will proceed.

Equation (3) illustrates the relationship between the equilibrium constant K_{eq} and ΔG^0 :

$$\Delta G^0 = -RT \ln K_{\text{eq}} \quad (3)$$

where R is the gas constant (1.98 cal/mol $^\circ$ K or 8.31 J/mol $^\circ$ K) and T is the absolute temperature in degrees Kelvin. K_{eq} is equal to the product of the concentrations of the reaction products, each raised to the power of their stoichiometry, divided by the product of the substrates, each raised to the power of their stoichiometry:

For the reaction $A + B \rightleftharpoons P + Q$

$$K_{\text{eq}} = \frac{[P][Q]}{[A][B]} \quad (4)$$

and for reaction (5)



$$K_{\text{eq}} = \frac{[P]}{[A]^2} \quad (6)$$

ΔG^0 may be calculated from equation (3) if the molar concentrations of substrates and products present at equilibrium are known. If ΔG^0 is a negative number, K_{eq} will be greater than unity, and the concentration of products at equilibrium will exceed that of the substrates. If ΔG^0 is positive, K_{eq} will be less than unity, and the formation of substrates will be favored.

Note that, since ΔG^0 is a function exclusively of the initial and final states of the reacting species, it can provide information only about the *direction* and *equilibrium state* of the reaction. ΔG^0 is independent of the **mechanism** of the reaction, and provides no information concerning **rates** of reactions. Consequently—and as explained below—although a reaction may have a large negative ΔG^0 or $\Delta G^{0'}$, it may nevertheless take place at a negligible rate.

THE RATES OF REACTIONS ARE DETERMINED BY THEIR ACTIVATION ENERGY

Reactions Proceed via Transition States

The concept of the **transition state** is fundamental to understanding the chemical and thermodynamic basis of catalysis. Equation (7) depicts a group transfer reaction in which an entering group E displaces a leaving group L, attached initially to R:



The net result of this process is to transfer group R from L to E. Midway through the displacement, the bond between R and L has weakened but has not yet been completely severed, and the new bond between E and R is yet incompletely formed. This transient intermediate—in which neither free substrate nor product exists—is termed the **transition state, E...R...L**. Dotted lines represent the “partial” bonds that are undergoing formation and rupture. Figure 8–1 provides a more detailed illustration of the transition state intermediate formed during the transfer of a phosphoryl group.

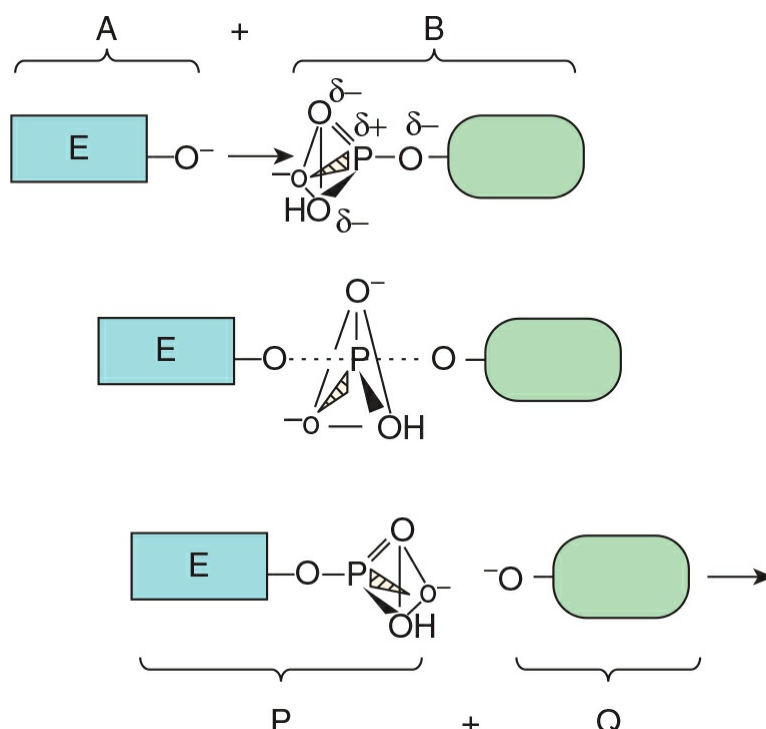

FIGURE 8–1 Formation of a transition state intermediate during a simple chemical reaction, $A + B \rightarrow P + Q$. Shown are three stages of a chemical reaction in which a phosphoryl group is transferred from leaving

group L (green) to entering group E (blue). **Top:** Entering group E (bracket A) approaches the other reactant, L-phosphate (bracket B). Notice how the three oxygen atoms linked by the triangular lines and the phosphorus atom of the phosphoryl group form a pyramid. **Center:** As E approaches L-phosphate, the new bond between E and the phosphoryl group begins to form (dotted line) as that linking L to the phosphoryl group weakens. These partially formed bonds are indicated by dotted lines. **Bottom:** Formation of the new product, E-phosphate (bracket P), is now complete as the leaving group L (bracket Q) exits. Notice how the geometry of the phosphoryl group differs between the transition state and the substrate or product. The phosphorus and three oxygen atoms that occupy the four corners of a pyramid in the substrate and product become coplanar, as emphasized by the triangle, in the transition state.

Reaction (7) can be thought of as consisting of two “partial reactions,” the first corresponding to the formation (F) and the second to the subsequent decay (D) of the transition state intermediate. As for all reactions, characteristic changes in free energy, ΔG_F and ΔG_D are associated with each partial reaction:



For the overall reaction (10), ΔG is the numeric sum of ΔG_F and ΔG_D . As for any equation of two terms, it is not possible to deduce from their resultant ΔG , either the sign or the magnitude of ΔG_F or ΔG_D .

Many reactions involve several successive transition states, each with an associated change in free energy. For these reactions, the overall ΔG represents the sum of *all* of the free-energy changes associated with the formation and decay of *all* of the transition states. **It therefore is not possible to infer from the overall ΔG** the number or type of transition states through which the reaction proceeds. Stated another way, *overall reaction thermodynamics tells us nothing about mechanism or kinetics.*

ΔG_F Defines the Activation Energy

Regardless of the sign or magnitude of ΔG , ΔG_F for the overwhelming majority of chemical reactions has a positive sign, which indicates that formation of the transition state requires surmounting one or more energy

barriers. For this reason, ΔG_F for reaching a transition state is often termed the **activation energy**, E_{act} . The ease—and hence the frequency—with which this barrier is overcome is *inversely* related to E_{act} . The thermodynamic parameters that determine how *fast* a reaction proceeds thus are the ΔG_F values for formation of the transition states through which the reaction proceeds. For a simple reaction, where \propto means “proportionate to,”

$$\text{Rate} \propto e^{-E_{act}/RT} \quad (11)$$

The activation energy for the reaction proceeding in the opposite direction to that drawn is equal to $-\Delta G_D$.

NUMEROUS FACTORS AFFECT REACTION RATE

The **kinetic theory**—also called the **collision theory**—of chemical kinetics states that for two molecules to react, they (1) must approach within bond-forming distance of one another, or “collide,” and (2) must possess sufficient kinetic energy to overcome the energy barrier for reaching the transition state. It therefore follows that conditions that tend to increase the *frequency* or *energy* of collision between substrates will tend to increase the rate of the reaction in which they participate.

Temperature

Raising the ambient temperature increases the kinetic energy of molecules. As illustrated in **Figure 8–2**, the total number of molecules whose kinetic energy exceeds the energy barrier E_{act} (vertical bar) for formation of products increases from low (A) through intermediate (B) to high (C) temperatures. Increasing the kinetic energy of molecules also increases their rapidity of motion, and therefore the frequency with which they collide. This combination of more frequent and more highly energetic, and hence productive, collisions increases the reaction rate.

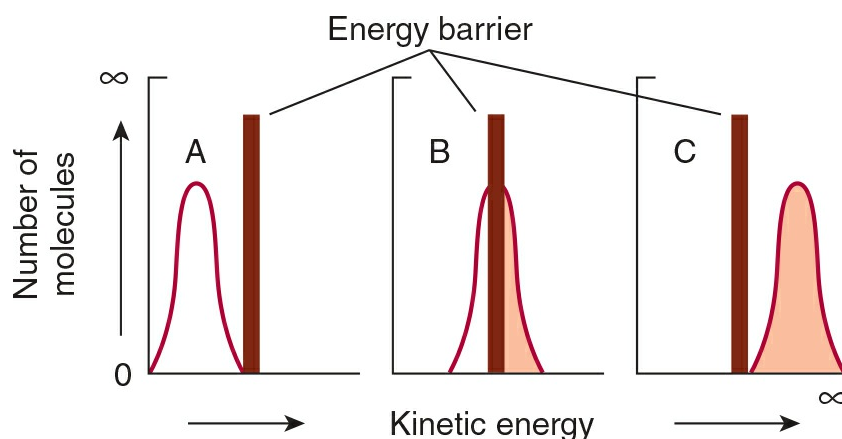
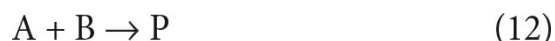

FIGURE 8–2 Representation of the energy barrier for chemical reactions. (See text for discussion.)

Reactant Concentration

The frequency with which molecules collide is directly proportionate to their concentrations. For two different molecules A and B, the frequency with which they collide will double if the concentration of either A or B is doubled. If the concentrations of both A and B are doubled, the probability of collision will increase fourfold.

For a chemical reaction proceeding at a constant temperature that involves one molecule each of A and B,



the fraction of the molecules possessing a given kinetic energy will be a constant. The number of collisions between molecules whose combined kinetic energy is sufficient to produce product P therefore will be directly proportionate to the number of collisions between A and B, and thus to their molar concentrations, denoted by the square brackets:

$$\text{Rate} \propto [A] [B] \quad (13)$$

Similarly, for the reaction represented by



which can also be written as



the corresponding rate expression is

$$\text{Rate} \propto [A] [B] [B] \quad (16)$$

or

$$\text{Rate} \propto [\text{A}][\text{B}]^2 \quad (17)$$

For the general case, when n molecules of A react with m molecules of B,



the rate expression is

$$\text{Rate} \propto [\text{A}]^n [\text{B}]^m \quad (19)$$

Replacing the proportionality sign with an equals sign by introducing a **rate constant, k** , characteristic of the reaction under study gives [equations \(20\) and \(21\)](#), in which the subscripts 1 and -1 refer to the forward and reverse reactions, respectively:

$$\text{Rate}_1 = k_1[\text{A}]^n[\text{B}]^m \quad (20)$$

$$\text{Rate}_{-1} = k_{-1}[\text{P}] \quad (21)$$

The sum of the molar ratios of the reactants defines the **kinetic order** of the reaction. Consider reaction (5). The stoichiometric coefficient for the sole reactant, A, is 2. Therefore, the rate of production of P is proportional to the square of [A] and the reaction is said to be *second order* with respect to reactant A. In this instance, the overall reaction is also *second order*. Therefore, k_1 is referred to as a *second-order rate constant*.

Reaction (12) describes a simple second-order reaction between two different reactants, A and B. The stoichiometric coefficient for each reactant is 1. Therefore, while the reaction is second order, it is said to be *first order* with respect to A and *first order* with respect to B.

In the laboratory, the kinetic order of a reaction with respect to a particular reactant, referred to as the variable reactant or substrate, can be determined by maintaining the concentration of the other reactants in large excess over the variable reactant. Under these *pseudo-first-order conditions*, the concentration of the “fixed” reactant remains virtually constant. Thus, the rate of reaction will depend exclusively on the concentration of the variable reactant, sometimes also called the limiting reactant. The concepts of reaction order and pseudo-first-order conditions apply not only to simple chemical reactions but also to enzyme-catalyzed reactions.

K_{eq} Is a Ratio of Rate Constants

While all chemical reactions are to some extent reversible, at equilibrium the *overall* concentrations of reactants and products remain constant. At

equilibrium, the rate of conversion of substrates to products therefore equals the rate at which products are converted to substrates:

$$\text{Rate}_1 = \text{Rate}_{-1} \quad (22)$$

Therefore,

$$k_1 = [A]^n[B]^m = k_{-1}[P] \quad (23)$$

and

$$\frac{k_1}{k_{-1}} = \frac{[P]}{[A]^n[B]^m} \quad (24)$$

The ratio of k_1 to k_{-1} is equal to the equilibrium constant, K_{eq} . The following important properties of a system at equilibrium must be kept in mind.

1. The equilibrium constant is a ratio of the reaction rate *constants* (not the reaction *rates*).
2. At equilibrium, the reaction *rates* (not the *rate constants*) of the forward and back reactions are equal.
3. The numeric value of the equilibrium constant K_{eq} can be calculated either from the concentrations of substrates and products at equilibrium or from the ratio k_1/k_{-1} .
4. Equilibrium is a *dynamic* state. Although there is no *net* change in the concentration of substrates or products, individual substrate and product molecules are continually being interconverted. Interconvertibility can be proved by adding to a system at equilibrium a trace of radioisotopic product, which can then be shown to result in the appearance of radiolabelled substrate.

THE KINETICS OF ENZYME CATALYSIS

Enzymes Lower the Activation Energy Barrier for a Reaction

All enzymes accelerate reaction rates by lowering ΔG_{F} for the formation of transition states. However, they may differ in the way this is achieved. While the sequence of chemical steps at the active site parallels those which occur when the substrates react in the absence of a catalyst, **the environment of the active site lowers ΔG_{F}** by stabilizing the transition

state intermediates. To put it another way, the enzyme can be envisioned as binding to the transition state intermediate (Figure 8–1) more tightly than it does to either substrates or products. As discussed in Chapter 7, stabilization can involve (1) acid–base groups suitably positioned to transfer protons to or from the developing transition state intermediate, (2) suitably positioned charged groups or metal ions that stabilize developing charges, or (3) the imposition of steric strain on substrates so that their geometry approaches that of the transition state. HIV protease (see Figure 7–6) illustrates catalysis by an enzyme that lowers the activation barrier in part by stabilizing a transition state intermediate.

Catalysis by enzymes that proceeds via a *unique* reaction mechanism typically occurs when the transition state intermediate forms a covalent bond with the enzyme (**covalent catalysis**). The catalytic mechanism of the serine protease chymotrypsin (see Figure 7–7) illustrates how an enzyme utilizes covalent catalysis to provide a unique reaction pathway possessing a more favorable E_{act} .

ENZYMES DO NOT AFFECT K_{eq}

While enzymes undergo transient modifications during the process of catalysis, they always emerge unchanged at the completion of the reaction. **The presence of an enzyme therefore has no effect on ΔG^0 for the overall reaction**, which is a function solely of the **initial and final states** of the reactants. Equation (25) shows the relationship between the equilibrium constant for a reaction and the standard free-energy change for that reaction:

$$\Delta G^0 = -RT \ln K_{\text{eq}} \quad (25)$$

This principle is perhaps most readily illustrated by including the presence of the enzyme (Enz) in the calculation of the equilibrium constant for an enzyme-catalyzed reaction:

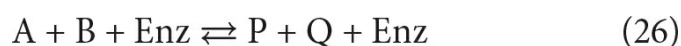

Since the enzyme on both sides of the double arrows is present in equal quantity and identical form, the expression for the equilibrium constant,

$$K_{\text{eq}} = \frac{[P][Q][\text{Enz}]}{[A][B][\text{Enz}]} \quad (27)$$

reduces to one identical to that for the reaction in the *absence* of the enzyme:

$$K_{\text{eq}} = \frac{[\text{P}][\text{Q}]}{[\text{A}][\text{B}]} \quad (28)$$

Enzymes therefore have no effect on K_{eq} .

MULTIPLE FACTORS AFFECT THE RATES OF ENZYME-CATALYZED REACTIONS

Temperature

Raising the temperature increases the rate of both uncatalyzed and enzyme-catalyzed reactions by increasing the kinetic energy and the collision frequency of the reacting molecules. However, heat energy can also increase the conformational flexing of the enzyme to a point that exceeds the energy barrier for disrupting the noncovalent interactions that maintain its three-dimensional structure. The polypeptide chain then begins to unfold, or **denature**, with an accompanying loss of the catalytic activity. The temperature range over which an enzyme maintains a stable, catalytically competent conformation depends on—and typically moderately exceeds—the normal temperature of the cells in which it resides. Enzymes from humans generally exhibit stability at temperatures up to 45 to 55°C. By contrast, enzymes from the thermophilic microorganisms that reside in volcanic hot springs or undersea hydrothermal vents may be stable at temperatures up to or even above 100°C.

The **temperature coefficient (Q₁₀)** is the factor by which the rate of a biologic process increases for a 10°C increase in temperature. For the temperatures over which enzymes are stable, the rates of most biologic processes typically double for a 10°C rise in temperature ($Q_{10} = 2$).

Changes in the rates of enzyme-catalyzed reactions that accompany a rise or fall in body temperature constitute a prominent survival feature for “cold-blooded” life forms such as lizards or fish, whose body temperatures are dictated by the external environment. However, for mammals and other homeothermic organisms, changes in enzyme reaction rates with temperature assume physiologic importance only in circumstances such as fever or hypothermia.

Hydrogen Ion Concentration

The rate of almost all enzyme-catalyzed reactions exhibits a significant dependence on hydrogen ion concentration. Most intracellular enzymes

exhibit optimal activity at pH values between 5 and 9. The relationship of activity to hydrogen ion concentration (**Figure 8–3**) reflects the balance between enzyme denaturation at high or low pH and effects on the charged state of the enzyme, the substrates, or both. For enzymes whose mechanism involves acid–base catalysis, the residues involved must be in the appropriate state of protonation for the reaction to proceed. The binding and recognition of substrate molecules with dissociable groups also typically involves the formation of salt bridges with the enzyme. The most common charged groups are carboxylate groups (negative) and protonated amines (positive). Gain or loss of critical charged groups adversely affects substrate binding and thus will retard or abolish catalysis.

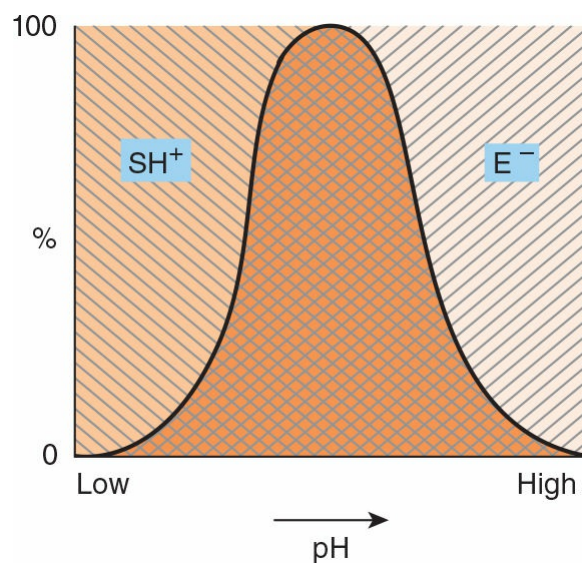

FIGURE 8–3 Effect of pH on enzyme activity. Consider, for example, a negatively charged enzyme (E^-) that binds a positively charged substrate (SH^+). Shown is the proportion (%) of SH^+ [\\/] and of E^- [///] as a function of pH. Only in the cross-hatched area do both the enzyme and the substrate bear an appropriate charge.

ASSAYS OF ENZYME-CATALYZED REACTIONS TYPICALLY MEASURE THE INITIAL VELOCITY

Most measurements of the rates of enzyme-catalyzed reactions employ relatively short time periods, conditions that are considered to approximate **initial rate conditions**. Under these conditions, only traces of product accumulate, rendering the rate of the reverse reaction negligible. The

initial velocity (v_i) of the reaction thus is essentially that of the rate of the forward reaction. Assays of enzyme activity almost always employ a large (10^3 - 10^6) molar excess of substrate over enzyme. Under these conditions, v_i is proportionate to the concentration of enzyme, that is, it is pseudo-first-order with respect to enzyme. Measuring the initial velocity therefore permits one to estimate the quantity of enzyme present in a biologic sample.

SUBSTRATE CONCENTRATION AFFECTS THE REACTION RATE

In what follows, enzyme reactions are treated as if they had only a single substrate and a single product. For enzymes with multiple substrates, the principles discussed below apply with equal validity. Moreover, by employing pseudo-first-order conditions (see above), scientists can study the dependence of reaction rate on an individual reactant through the appropriate choice of fixed and variable substrates. In other words, under pseudo-first-order conditions the behavior of a multisubstrate enzyme will imitate one having a single substrate. In this instance, however, the observed rate constant will be a function both of the rate constant k_1 for the reaction and of the concentration of the fixed substrate.

For a typical enzyme, as substrate concentration is increased, v_i increases until it reaches a maximum value V_{\max} (**Figure 8-4**). When further increases in substrate concentration fail to increase v_i , the enzyme is said to be “saturated” with the substrate. Note that the shape of the curve that relates activity to substrate concentration (**Figure 8-4**) is *hyperbolic*. At any given instant, only substrate molecules that are combined with the enzyme as an enzyme-substrate (ES) complex can be transformed into a product. Since the equilibrium constant for the formation of the enzyme-substrate complex is not infinitely large, only a fraction of the enzyme may be present as an ES complex even when the substrate is present in considerable excess (points A and B of **Figure 8-5**). At points A or B, increasing or decreasing $[S]$ therefore will increase or decrease the number of ES complexes with a corresponding change in v_i . At point C (**Figure 8-5**), however, essentially all the enzyme is present as the ES complex. Since no free enzyme remains available for forming ES, further increases in $[S]$ cannot increase the rate of the reaction. **Under these saturating conditions, v_i depends solely on—and thus is limited by—the rapidity**

with which product dissociates from the enzyme so that it may combine with more substrate.

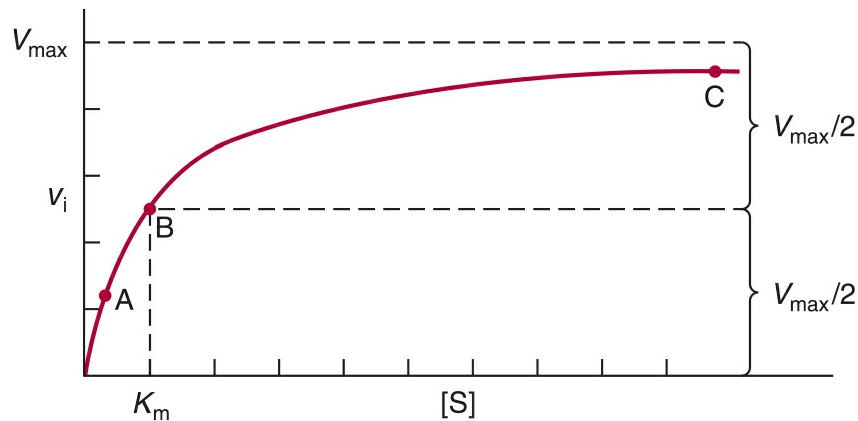

FIGURE 8–4 Effect of substrate concentration on the initial velocity of an enzyme-catalyzed reaction.

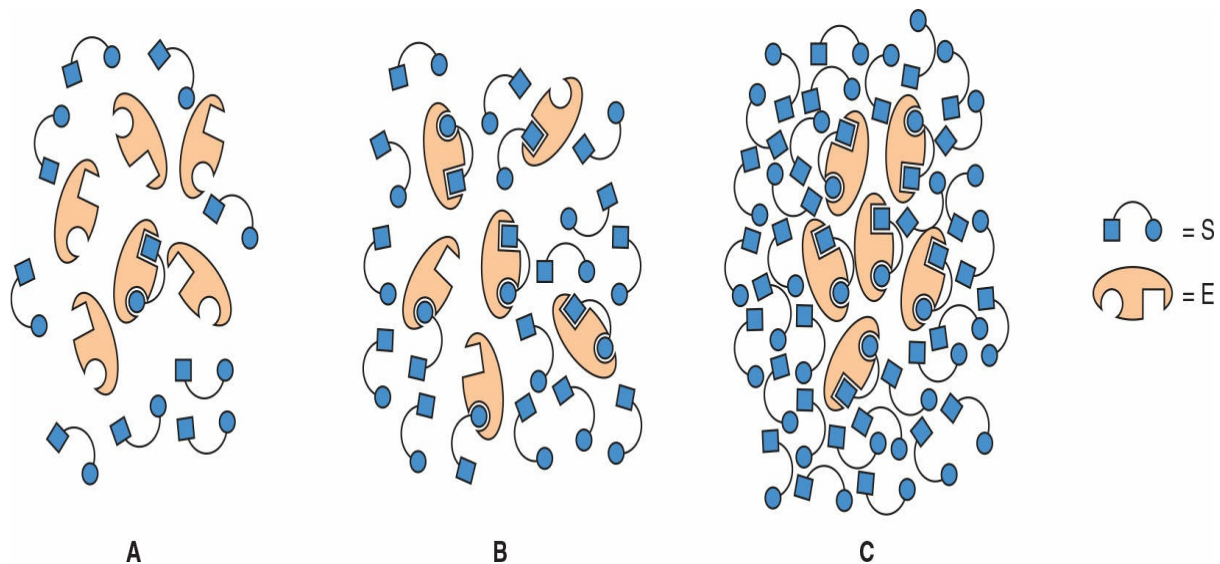

FIGURE 8–5 Representation of an enzyme in the presence of a concentration of substrate that is below K_m (A), at a concentration equal to K_m (B), and at a concentration well above K_m (C). Points A, B, and C correspond to those points in [Figure 8–4](#).

THE MICHAELIS-MENTEN & HILL EQUATIONS MODEL THE EFFECTS OF SUBSTRATE CONCENTRATION

The Michaelis-Menten Equation

The Michaelis-Menten [equation \(29\)](#) illustrates in mathematical terms the relationship between initial reaction velocity v_i and substrate concentration $[S]$, shown graphically in [Figure 8–4](#):

$$v_i = \frac{V_{\max}[S]}{K_m + [S]} \quad (29)$$

The Michaelis constant K_m is the substrate concentration at which v_i is half the maximal velocity ($V_{\max}/2$) attainable at a particular concentration of the enzyme. K_m thus has the dimensions of substrate concentration. The dependence of initial reaction velocity on $[S]$ and K_m may be illustrated by evaluating the Michaelis-Menten equation under three conditions.

1. When $[S]$ is much less than K_m (point A in [Figures 8–4](#) and [8–5](#)), the term $K_m + [S]$ is essentially equal to K_m . Replacing $K_m + [S]$ with K_m reduces [equation \(29\)](#) to

$$v_i = \frac{V_{\max}[S]}{K_m + [S]} \quad v_i \approx \frac{V_{\max}[S]}{K_m} \approx \left(\frac{V_{\max}}{K_m} \right) [S] \quad (30)$$

where \approx means “approximately equal to.” Since V_{\max} and K_m are both constants, their ratio is a constant. In other words, when $[S]$ is considerably below K_m , v_i is proportionate to $k[S]$. The initial reaction velocity therefore is directly proportional to $[S]$.

2. When $[S]$ is much greater than K_m (point C in [Figures 8–4](#) and [8–5](#)), the term $K_m + [S]$ is essentially equal to $[S]$. Replacing $K_m + [S]$ with $[S]$ reduces [equation \(29\)](#) to

$$v_i = \frac{V_{\max}[S]}{K_m + [S]} \quad v_i \approx \frac{V_{\max}[S]}{[S]} \approx V_{\max} \quad (31)$$

Thus, when $[S]$ greatly exceeds K_m , the reaction velocity is maximal (V_{\max}) and unaffected by further increases in the substrate concentration.

3. When $[S] = K_m$ (point B in [Figures 8–4](#) and [8–5](#)):

$$v_i = \frac{V_{\max}[S]}{K_m + [S]} = \frac{V_{\max}[S]}{2[S]} = \frac{V_{\max}}{2} \quad (32)$$

[Equation \(32\)](#) states that when $[S]$ equals K_m , the initial velocity is half-

maximal. Equation (32) also reveals that K_m is—and may be determined experimentally from—the substrate concentration at which the initial velocity is half-maximal.

A Linear Form of the Michaelis-Menten Equation Is Used to Determine K_m & V_{max}

The direct measurement of the numeric value of V_{max} , and therefore the calculation of K_m , often requires impractically high concentrations of substrate to achieve saturating conditions. A linear form of the Michaelis-Menten equation circumvents this difficulty and permits V_{max} and K_m to be extrapolated from initial velocity data obtained at less than saturating concentrations of the substrate. Start with equation (29),

$$v_i = \frac{V_{max}[S]}{K_m + [S]} \quad (29)$$

invert

$$\frac{1}{v_i} = \frac{K_m + [S]}{V_{max}[S]} \quad (33)$$

factor

$$\frac{1}{v_i} = \frac{K_m}{V_{max}[S]} + \frac{[S]}{V_{max}[S]} \quad (34)$$

and simplify

$$\frac{1}{v_i} = \left(\frac{K_m}{V_{max}} \right) \frac{1}{[S]} + \frac{1}{V_{max}} \quad (35)$$

Equation (35) is the equation for a straight line, $y = ax + b$, where $y = 1/v_i$ and $x = 1/[S]$. A plot of $1/v_i$ as y as a function of $1/[S]$ as x therefore gives a straight line whose y intercept is $1/V_{max}$ and whose slope is K_m/V_{max} .

Such a plot is called a **double reciprocal** or **Lineweaver-Burk plot** (Figure 8–6). Setting the y term of equation (36) equal to zero and solving for x reveals that the x intercept is $-1/K_m$:

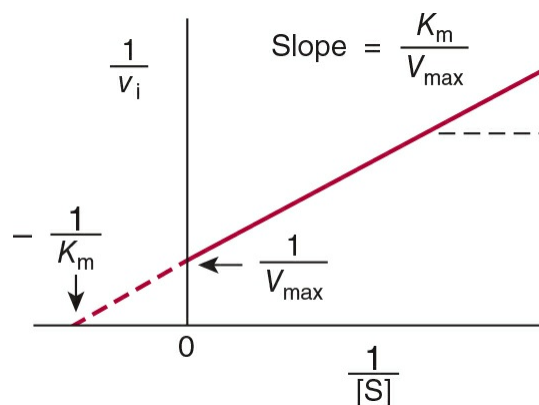

FIGURE 8–6 Double-reciprocal or Lineweaver-Burk plot of $1/v_i$ versus $1/[S]$ used to evaluate K_m and V_{max} .

$$0 = ax + b; \text{ therefore, } x = \frac{-b}{a} = \frac{-1}{K_m} \quad (36)$$

K_m can be calculated from the slope and y intercept, but is perhaps most readily calculated from the negative x intercept.

The greatest virtue of the Lineweaver-Burk plot resides in the facility with which it can be used to determine the kinetic mechanism of an enzyme inhibitor (see below). However, in using a double-reciprocal plot to determine kinetic constants, it is important to avoid the introduction of bias through the clustering of data at low values of $1/[S]$. This bias can be readily avoided in the laboratory as follows. Prepare a solution of substrate whose dilution into an assay will produce the maximum desired concentration of the substrate. Now prepare dilutions of the stock solution by factors of 1:2, 1:3, 1:4, 1:5, etc. Data generated using equal volumes of these dilutions will then fall on the $1/[S]$ axis at equally spaced intervals of 1, 2, 3, 4, 5, etc. A single-reciprocal plot such as the Eadie-Hofstee (v_i vs $v_i/[S]$) or Hanes-Woolf ($[S]/v_i$ vs $[S]$) plot can also be used to minimize data clustering.

The Catalytic Constant, k_{cat}

Several parameters may be used to compare the relative activity of different enzymes or of different preparations of the same enzyme. The activity of impure enzyme preparations typically is expressed as a *specific activity* (V_{max} divided by the protein concentration). For a homogeneous enzyme, one may calculate its *turnover number* (V_{max} divided by the moles of enzyme present). However, if the number of active sites present

is known, the catalytic activity of a homogeneous enzyme is best expressed as its *catalytic constant*, k_{cat} (V_{max} divided by the number of active sites, S_t):

$$k_{\text{cat}} = \frac{V_{\text{max}}}{S_t} \quad (37)$$

Since the units of concentration cancel out, the units of k_{cat} are reciprocal time.

Catalytic Efficiency, k_{cat}/K_m

By what measure should the efficiency of different enzymes, different substrates for a given enzyme, and the efficiency with which an enzyme catalyzes a reaction in the forward and reverse directions be quantified and compared? While the maximum capacity of a given enzyme to convert substrate to product is important, the benefits of a high k_{cat} can only be realized if K_m is sufficiently low. Thus, *catalytic efficiency* of enzymes is best expressed in terms of the *ratio* of these two kinetic constants, k_{cat}/K_m .

For certain enzymes, once substrate binds to the active site, it is converted to product and released so rapidly as to render these events effectively instantaneous. For these exceptionally efficient catalysts, the rate-limiting step in catalysis is the formation of the ES complex. Such enzymes are said to be *diffusion-limited*, or catalytically perfect, since the fastest possible rate of catalysis is determined by the rate at which molecules move or diffuse through the solution. Examples of enzymes for which k_{cat}/K_m approaches the diffusion limit of 10^8 - $10^9 \text{ M}^{-1}\text{s}^{-1}$ include triosephosphate isomerase, carbonic anhydrase, acetylcholinesterase, and adenosine deaminase.

In living cells, the assembly of enzymes that catalyze successive reactions into multimeric complexes can circumvent the limitations imposed by diffusion. The geometric relationships of the enzymes in these complexes are such that the substrates and products do not diffuse into the bulk solution until the last step in the sequence of catalytic steps is complete. Fatty acid synthetase extends this concept one step further by covalently attaching the growing substrate fatty acid chain to a biotin tether that rotates from active site to active site within the complex until synthesis of a palmitic acid molecule is complete (see [Chapter 23](#)).

K_m May Approximate a Binding Constant

The affinity of an enzyme for its substrate is the inverse of the dissociation constant K_d for dissociation of the enzyme-substrate complex ES:



$$K_d = \frac{k_{-1}}{k_1} \quad (39)$$

Stated another way, the *smaller* the tendency of the enzyme and its substrate to *dissociate*, the *greater* the affinity of the enzyme for its substrate. While the Michaelis constant K_m often approximates the dissociation constant K_d , this should not be assumed, for it is by no means always the case. For a typical enzyme-catalyzed reaction:

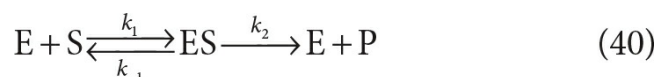

The value of $[S]$ that gives $v_i = V_{\max}/2$ is

$$[S] = \frac{k_{-1} + k_2}{k_1} = K_m \quad (41)$$

When $k_{-1} \gg k_2$, then

$$k_{-1} + k_2 \approx k_{-1} \quad (42)$$

and

$$[S] \approx \frac{k_1}{k_{-1}} = K_d \quad (43)$$

Hence, $1/K_m$ only approximates $1/K_d$ under conditions where the association and dissociation of the ES complex are rapid relative to catalysis. For the many enzyme-catalyzed reactions for which $k_{-1} + k_2$ is **not** approximately equal to k_{-1} , $1/K_m$ will underestimate $1/K_d$.

The Hill Equation Describes the Behavior of Enzymes That Exhibit Cooperative Binding of Substrate

While most enzymes display the simple **saturation kinetics** depicted in [Figure 8–4](#) and are adequately described by the Michaelis-Menten expression, some enzymes bind their substrates in a **cooperative** fashion

analogous to the binding of oxygen by hemoglobin (see [Chapter 6](#)). Cooperative behavior is an *exclusive* property of multimeric enzymes that bind substrate at multiple sites.

For enzymes that display positive cooperativity in binding the substrate, the shape of the curve that relates changes in v_i to changes in $[S]$ is sigmoidal ([Figure 8–7](#)). Neither the Michaelis-Menten expression nor its derived plots can be used to evaluate cooperative kinetics. Enzymologists therefore employ a graphic representation of the **Hill equation** originally derived to describe the cooperative binding of O_2 by hemoglobin.

[Equation \(44\)](#) represents the Hill equation arranged in a form that predicts a straight line, where k' is a complex constant:

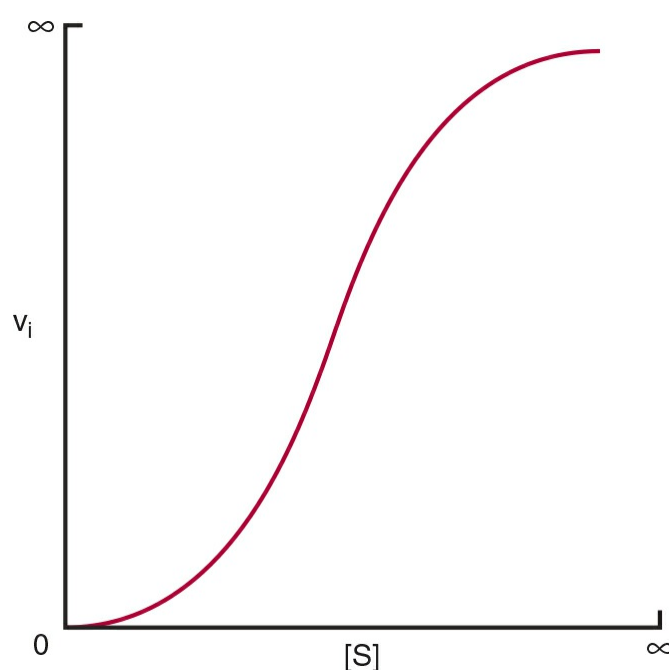

FIGURE 8–7 Representation of sigmoid substrate saturation kinetics.

$$\frac{\log v_i}{V_{\max} - v_i} = n \log[S] - \log k' \quad (44)$$

[Equation \(44\)](#) states that when $[S]$ is low relative to k' , the initial reaction velocity increases as the n th power of $[S]$.

A graph of $\log v_i/(V_{\max} - v_i)$ versus $\log[S]$ gives a straight line ([Figure 8–8](#)). The slope of the line, n , is the **Hill coefficient**, an empirical parameter whose value is a function of the number, kind, and strength of the interactions of the multiple substrate-binding sites on the enzyme. When $n = 1$, all binding sites behave independently and simple Michaelis-Menten kinetic behavior is observed. If n is greater than 1, the enzyme is

said to exhibit **positive cooperativity**. Binding of substrate to one site then enhances the affinity of the remaining sites to bind additional substrate. The greater the value for n , the higher the degree of cooperativity and the more markedly sigmoidal will be the plot of v_i versus $[S]$. A perpendicular dropped from the point where the y term $\log v_i/(V_{\max} - v_i)$ is zero intersects the x-axis at a substrate concentration termed S_{50} , the substrate concentration that results in half-maximal velocity, S_{50} , thus is analogous to the P_{50} for oxygen binding to hemoglobin (see [Chapter 6](#)).

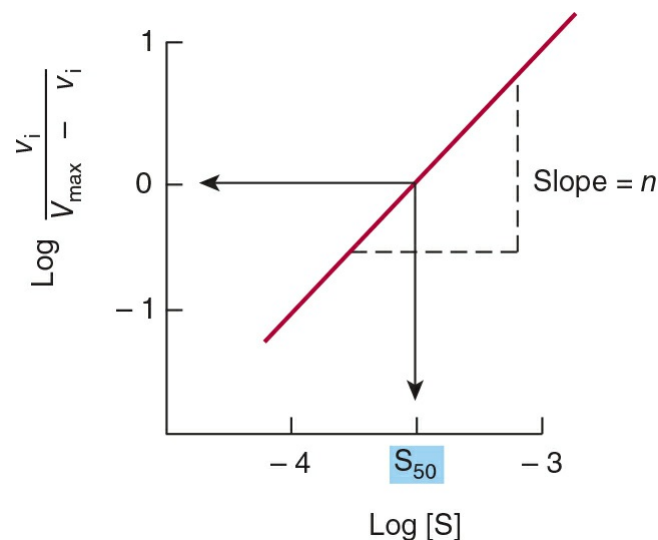

FIGURE 8–8 A graphical representation of a linear form of the Hill equation is used to evaluate S_{50} , the substrate concentration that produces half-maximal velocity, and the degree of cooperativity n .

KINETIC ANALYSIS DISTINGUISHES COMPETITIVE FROM NONCOMPETITIVE INHIBITION

Inhibitors of the catalytic activities of enzymes provide both pharmacologic agents and research tools for the study of the mechanism of enzyme action. The strength of the interaction between an inhibitor and an enzyme depends on forces important in protein structure and ligand binding (hydrogen bonds, electrostatic interactions, hydrophobic interactions, and van der Waals forces; see [Chapter 5](#)). Inhibitors can be classified on the basis of their site of action on the enzyme, on whether they chemically modify the enzyme, or on the kinetic parameters they influence. Compounds that mimic the transition state of an enzyme-

catalyzed reaction (**transition state analogs**) or that take advantage of the catalytic machinery of an enzyme (**mechanism-based inhibitors**) can be particularly potent inhibitors. Kinetically, we distinguish two classes of inhibitors based on whether raising the substrate concentration does or does not overcome the inhibition.

Competitive Inhibitors Typically Resemble Substrates

The effects of competitive inhibitors can be overcome by raising the concentration of substrate. Most frequently, in competitive inhibition, the inhibitor (**I**) binds to the substrate-binding portion of the active site thereby blocking access by the substrate. The structures of most classic competitive inhibitors therefore tend to resemble the structure of a substrate, and thus are termed **substrate analogs**. Inhibition of the enzyme succinate dehydrogenase by malonate illustrates competitive inhibition by a substrate analog. Succinate dehydrogenase catalyzes the removal of one hydrogen atom from each of the two methylene carbons of succinate (**Figure 8–9**). Both succinate and its structural analog malonate (${}^{-}\text{OOC}-\text{CH}_2-\text{COO}^{-}$) can bind to the active site of succinate dehydrogenase, forming an ES or an EI complex, respectively. However, since malonate contains only one methylene carbon, it cannot undergo dehydrogenation.

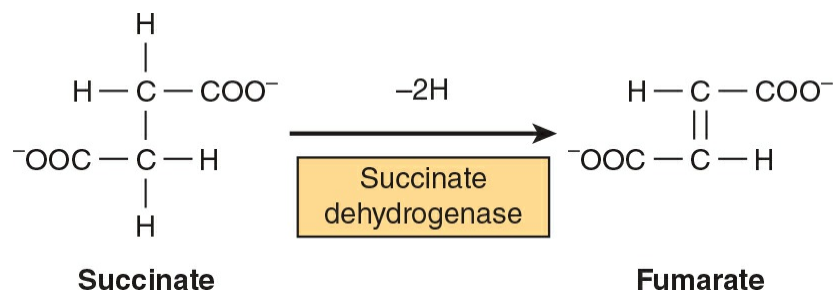

FIGURE 8–9 The succinate dehydrogenase reaction.

The formation and dissociation of the EI complex is a dynamic process described by



for which the equilibrium constant K_i is

$$K_i = \frac{[\text{E}][\text{I}]}{[\text{E} - \text{I}]} = \frac{k_1}{k_{-1}} \quad (46)$$

In effect, **a competitive inhibitor acts by decreasing the number of free enzyme molecules available to bind substrate, that is, to form ES, and thus eventually to form product**, as described below.

A competitive inhibitor and substrate exert reciprocal effects on the concentration of the EI and ES complexes. Since the formation of ES complexes removes free enzyme available to combine with the inhibitor, increasing $[S]$ *decreases* the concentration of the EI complex and *raises* the reaction velocity. The extent to which $[S]$ must be increased to completely overcome the inhibition depends on the concentration of the inhibitor present, its affinity for the enzyme (K_i), and the affinity, K_m , of the enzyme for its substrate.

Double-Reciprocal Plots Facilitate the Evaluation of Inhibitors

Double-reciprocal plots typically are used both to distinguish between competitive and noncompetitive inhibitors and to simplify evaluation of inhibition constants. v_i is determined at several substrate concentrations both in the presence and in the absence of the inhibitor. For classic competitive inhibition, the lines that connect the experimental data point converge at the y -axis (**Figure 8–10**). Since the y intercept is equal to $1/V_{\max}$, this pattern indicates that **when $1/[S]$ approaches 0, v_i is independent of the presence of inhibitor**. Note, however, that the intercept on the x -axis *does* vary with inhibitor concentration and that, since $-1/K'_m$ is smaller than $-1/K_m$, K'_m (the “apparent K_m ”) becomes larger in the presence of increasing concentrations of the inhibitor. Thus, **a competitive inhibitor has no effect on V_{\max} but raises K'_m , the apparent K_m for the substrate**. For a simple competitive inhibition, the intercept on the x -axis is

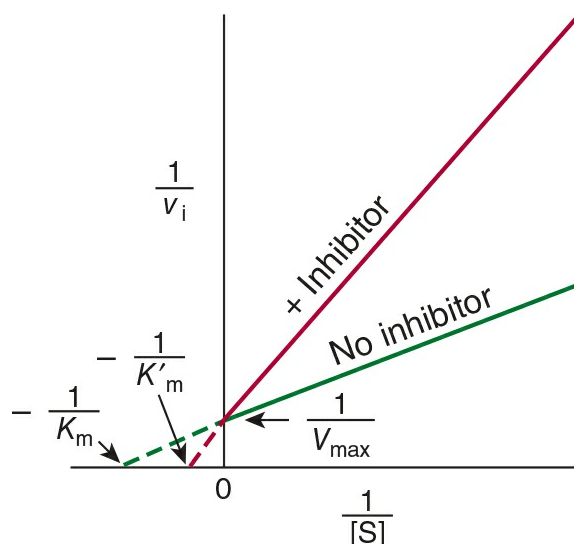

FIGURE 8–10 Lineweaver-Burk plot of simple competitive inhibition. Note the complete relief of inhibition at high [S] (ie, low $1/[S]$).

$$x = \frac{-1}{K_m} \left(1 + \frac{[I]}{K_i} \right) \quad (47)$$

Once K_m has been determined in the absence of inhibitor, K_i can be calculated from [equation \(47\)](#). K_i values are used to compare different inhibitors of the same enzyme. The *lower* the value for K_i , the more effective the inhibitor. For example, the statin drugs that act as competitive inhibitors of 3-hydroxy-3-methylglutaryl coenzyme A (HMG-CoA) reductase (see [Chapter 26](#)) have K_i values several orders of magnitude lower than the K_m for the substrate, HMG-CoA.

Simple Noncompetitive Inhibitors Lower V_{max} but Do Not Affect K_m

In strict noncompetitive inhibition, binding of the inhibitor does not affect binding of the substrate. Formation of both EI and enzyme inhibitor substrate (EIS) complexes is therefore possible. However, while the enzyme-inhibitor complex can still bind the substrate, its efficiency at transforming substrate to product, reflected by V_{max} , is decreased.

Noncompetitive inhibitors bind enzymes at sites distinct from the substrate-binding site and generally bear little or no structural resemblance to the substrate.

For simple noncompetitive inhibition, E and EI possess identical

affinity for the substrate, and the EIS complex generates product at a negligible rate (**Figure 8–11**). More complex noncompetitive inhibition occurs when binding of the inhibitor *does* affect the apparent affinity of the enzyme for the substrate, causing the lines to intercept in either the third or fourth quadrants of a double-reciprocal plot (not shown). While certain inhibitors exhibit characteristics of a mixture of competitive and noncompetitive inhibition, the evaluation of these inhibitors exceeds the scope of this chapter.

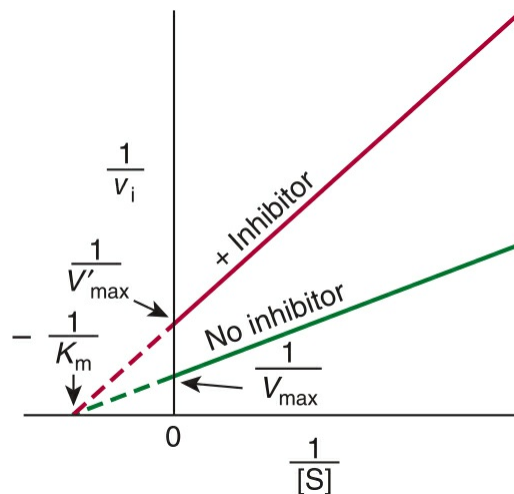

FIGURE 8–11 Lineweaver-Burk plot for simple noncompetitive inhibition.

Dixon Plot

A Dixon plot is sometimes employed as an alternative to the Lineweaver-Burk plot for determining inhibition constants. The initial velocity (v_i) is measured at several concentrations of the inhibitor, but at a fixed concentration of the substrate (S). For a simple competitive or noncompetitive inhibitor, a plot of $1/v_i$ versus inhibitor concentration $[I]$ yields a straight line. The experiment is repeated at different fixed concentrations of the substrate. The resulting set of lines intersects to the left of the y -axis. For *competitive* inhibition, a perpendicular dropped to the x -axis from the point of intersection of the lines gives $-K_i$ (**Figure 8–12**, top). For *noncompetitive* inhibition, the intercept on the x -axis is $-K_i$ (**Figure 8–12**, bottom). Pharmaceutical publications frequently employ Dixon plots to illustrate the comparative potency of competitive inhibitors.

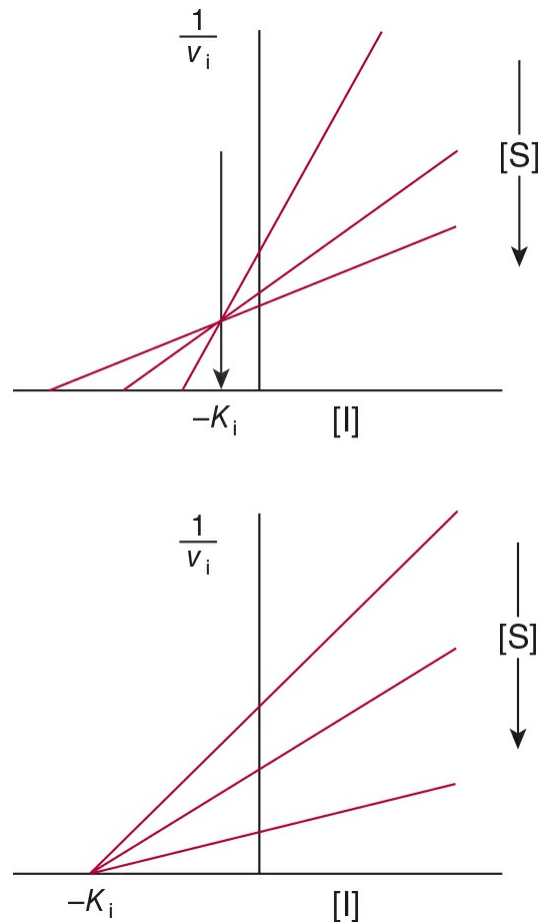

FIGURE 8–12 Applications of Dixon plots. Top: Competitive inhibition, estimation of K_i . **Bottom:** Noncompetitive inhibition, estimation of K_i .

IC₅₀

A less rigorous alternative to K_i as a measure of inhibitory potency is the concentration of inhibitor that produces 50% inhibition, IC_{50} . Unlike the equilibrium dissociation constant K_i , the numeric value of IC_{50} varies as a function of the specific circumstances of substrate concentration, etc under which it is determined.

Tightly Bound Inhibitors

Some inhibitors bind to enzymes with such high affinity, $K_i \leq 10^{-9}$ M, that the concentration of inhibitor required to measure K_i falls below the concentration of enzyme typically present in an assay. Under these circumstances, a significant fraction of the total inhibitor may be present as

an EI complex. If so, this violates the assumption, implicit in classical steady-state kinetics, that the concentration of free inhibitor is independent of the concentration of enzyme. The kinetic analysis of these tightly bound inhibitors requires specialized kinetic equations that incorporate the concentration of enzyme to estimate K_i or IC_{50} and to distinguish competitive from noncompetitive tightly bound inhibitors.

Irreversible Inhibitors “Poison” Enzymes

In the above examples, the inhibitors form a dissociable, dynamic complex with the enzyme. Fully active enzyme can therefore be recovered simply by removing the inhibitor from the surrounding medium. However, a variety of other inhibitors act *irreversibly* by chemically modifying the enzyme. These modifications generally involve making or breaking covalent bonds with aminoacyl residues essential for substrate binding, catalysis, or maintenance of the enzyme’s functional conformation. Since these covalent changes are relatively stable, an enzyme that has been “poisoned” by an irreversible inhibitor such as a heavy metal atom or an acylating reagent remains inhibited even after the removal of the remaining inhibitor from the surrounding medium.

Mechanism-Based Inhibition

“Mechanism-based” or “suicide” inhibitors are specialized substrate analogs that contain a chemical group that can be transformed by the catalytic machinery of the target enzyme. After binding to the active site, catalysis by the enzyme generates a highly reactive group that forms a covalent bond to and **blocks the function of a catalytically essential residue**. The specificity and persistence of suicide inhibitors, which are both enzyme-specific and unreactive outside the confines of the enzyme’s active site, render them promising leads for the development of enzyme-specific drugs. The kinetic analysis of suicide inhibitors lies beyond the scope of this chapter. Neither the Lineweaver-Burk nor the Dixon approach is applicable since suicide inhibitors violate a key boundary condition common to both approaches, namely that the activity of the enzyme does not decrease during the course of the assay.

MOST ENZYME-CATALYZED REACTIONS INVOLVE TWO OR MORE SUBSTRATES

While several enzymes have a single substrate, many others have two—and sometimes more—substrates and products. The fundamental principles discussed above, while illustrated for single-substrate enzymes, apply also to multisubstrate enzymes. The mathematical expressions used to evaluate multisubstrate reactions are, however, complex. While a detailed analysis of the full range of multisubstrate reactions exceeds the scope of this chapter, some common types of kinetic behavior for two-substrate, two-product reactions (termed “Bi-Bi” reactions) are considered below.

Sequential or Single-Displacement Reactions

In **sequential reactions**, both substrates must combine with the enzyme to form a ternary complex before catalysis can proceed (**Figure 8–13**, top). Sequential reactions are sometimes referred to as single-displacement reactions because the group undergoing transfer is usually passed directly, in a single step, from one substrate to the other. Sequential Bi-Bi reactions can be further distinguished on the basis of whether the two substrates add in a **random** or in a **compulsory** order. For random-order reactions, either substrate A or substrate B may combine first with the enzyme to form an EA or an EB complex (**Figure 8–13**, center). For compulsory-order reactions, A must first combine with E before B can combine with the EA complex. One explanation for why some enzymes follow a compulsory-order mechanism can be found in Koshland’s induced fit hypothesis: the addition of A induces a conformational change in the enzyme that aligns residues that recognize and bind B.

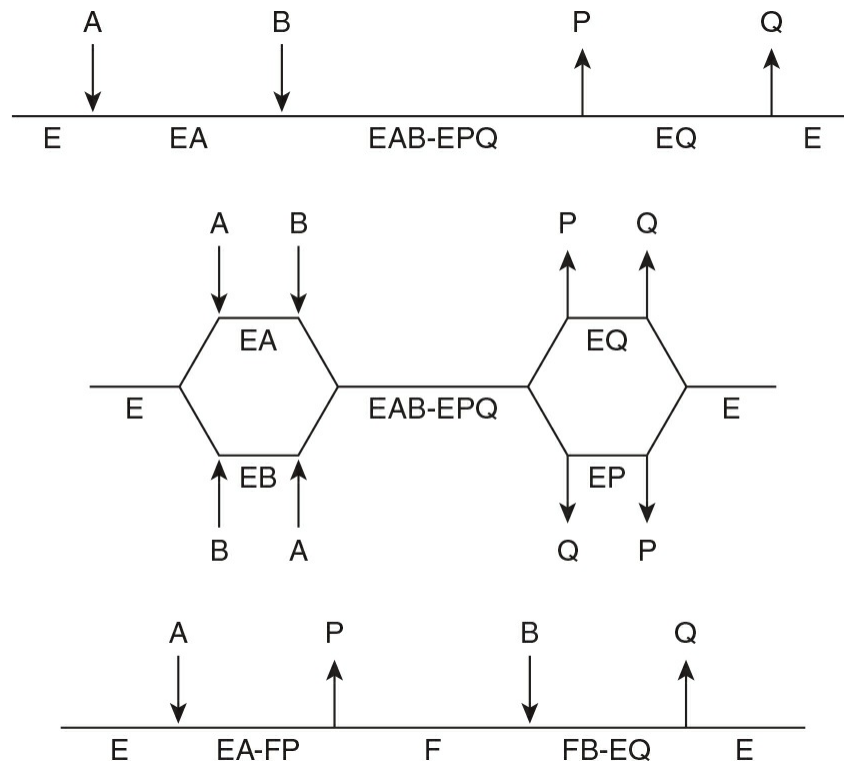

FIGURE 8–13 Representations of three classes of Bi-Bi reaction mechanisms. Horizontal lines represent the enzyme. Arrows indicate the addition of substrates and departure of products. **Top:** an ordered Bi-Bi reaction, characteristic of many NAD(P)H-dependent oxidoreductases. **Center:** a random Bi-Bi reaction, characteristic of many kinases and some dehydrogenases. **Bottom:** a ping-pong reaction, characteristic of aminotransferases and serine proteases.

Ping-Pong Reactions

The term “**ping-pong**” applies to mechanisms in which one or more products are released from the enzyme before all the substrates have been added. Ping-pong reactions involve covalent catalysis and a transient, modified form of the enzyme (see [Figure 7–4](#)). Ping-pong Bi-Bi reactions are often referred to as **double displacement reactions**. The group undergoing transfer is first displaced from substrate A by the enzyme to form product P and a modified form of the enzyme (F). The subsequent group transfer from F to the second substrate B, forming product Q and regenerating E, constitutes the second displacement ([Figure 8–13](#), bottom).

Most Bi-Bi Reactions Conform to Michaelis-Menten

Kinetics

Most Bi-Bi reactions conform to a somewhat more complex form of Michaelis-Menten kinetics in which V_{\max} refers to the reaction rate attained when *both* substrates are present at saturating levels. Each substrate has its own characteristic K_m value, which corresponds to the concentration that yields half-maximal velocity when the second substrate is present at saturating levels. As for single-substrate reactions, double-reciprocal plots can be used to determine V_{\max} and K_m . v_i is measured as a function of the concentration of one substrate (the variable substrate) while the concentration of the other substrate (the fixed substrate) is maintained constant. If the lines obtained for several fixed-substrate concentrations are plotted on the same graph, it is possible to distinguish a ping-pong mechanism, which yields parallel lines (**Figure 8–14**), from a sequential mechanism, which yields a pattern of intersecting lines (not shown).

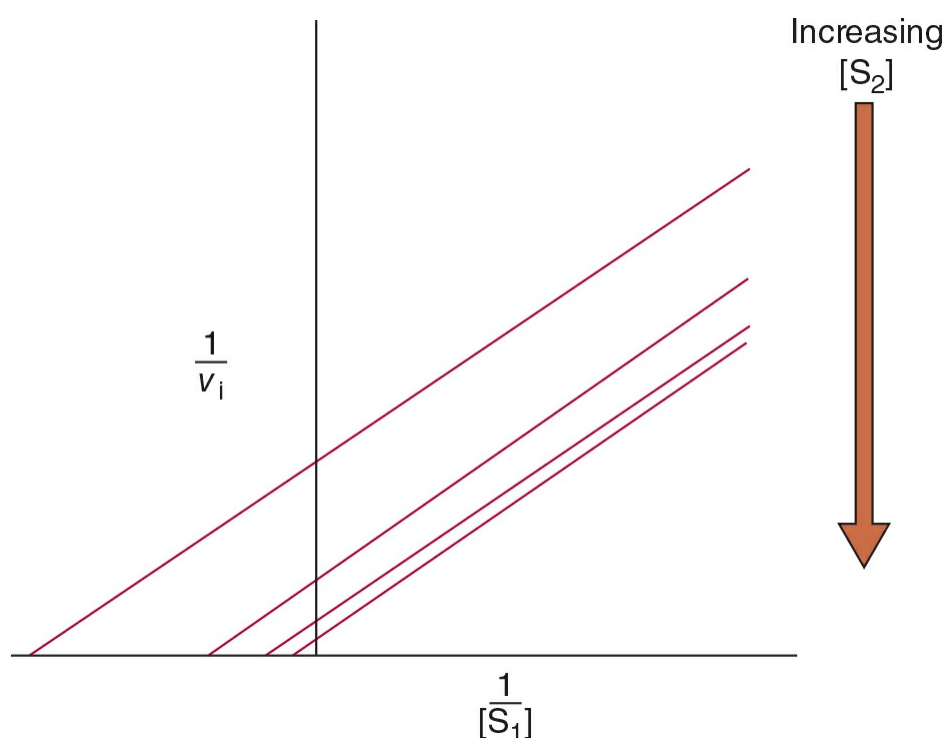

FIGURE 8–14 Lineweaver-Burk plot for a two-substrate ping-pong reaction. Increasing the concentration of one substrate (S_1) while maintaining that of the other substrate (S_2) constant alters both the x and y intercepts, but not the slope.

Product inhibition studies are used to complement kinetic analyses and to distinguish between ordered and random Bi-Bi reactions. For

example, in a random-order Bi-Bi reaction, each product will act as a competitive inhibitor in the absence of its coproducts regardless of which substrate is designated the variable substrate. However, for a sequential mechanism (Figure 8–13, top), only product Q will give the pattern indicative of competitive inhibition when A is the variable substrate, while only product P will produce this pattern with B as the variable substrate. The other combinations of product inhibitor and variable substrate will produce forms of complex noncompetitive inhibition.

KNOWLEDGE OF ENZYME KINETICS, MECHANISM, AND INHIBITION AIDS DRUG DEVELOPMENT

Many Drugs Act as Enzyme Inhibitors

The goal of pharmacology is to identify agents that can:

1. Destroy or impair the growth, invasiveness, or development of invading pathogens.
2. Stimulate endogenous defense mechanisms.
3. Halt or impede aberrant molecular processes triggered by genetic, environmental, or biologic stimuli with minimal perturbation of the host's normal cellular functions.

By virtue of their diverse physiologic roles and high degree of substrate selectivity, enzymes constitute natural targets for the development of pharmacologic agents that are both potent and specific. Statin drugs, for example, lower cholesterol production by inhibiting the enzyme HMG-CoA reductase (see Chapter 26), while emtricitabine and tenofovir disoproxil fumarate block replication of the human immunodeficiency virus by inhibiting the viral reverse transcriptase (see Chapter 34). Pharmacologic treatment of hypertension often includes the administration of an inhibitor of angiotensin-converting enzyme, thus lowering the level of angiotensin II, a vasoconstrictor (see Chapter 42).

Enzyme Kinetics Defines Appropriate Screening Conditions

Enzyme kinetics plays a crucial role in drug discovery. Knowledge of the kinetic behavior of the enzyme of interest is necessary, first and foremost,

to select appropriate assay conditions for detecting the presence of an inhibitor. The concentration of substrate, for example, must be adjusted such that sufficient product is generated to permit facile detection of the enzyme's activity without being so high that it masks the presence of an inhibitor. Second, enzyme kinetics provides the means for quantifying and comparing the potency of different inhibitors and defining their mode of action. Noncompetitive inhibitors are particularly desirable, because—by contrast to competitive inhibitors—their effects can never be completely overcome by increases in substrate concentration.

Most Drugs Are Metabolized In Vivo

Drug development often involves more than the kinetic evaluation of the interaction of inhibitors with the target enzyme. In order to minimize its effective dosage, and hence the potential for deleterious side effects, a drug needs to be resistant to degradation by enzymes present in the patient or pathogen, a process termed **drug metabolism**. For example, penicillin and other β -lactam antibiotics block cell wall synthesis in bacteria by irreversibly inactivating the enzyme alanine carboxypeptidase-transpeptidase. Many bacteria, however, produce β -lactamases that hydrolyze the critical β -lactam function in penicillin and related drugs. One strategy for overcoming the resulting antibiotic resistance is to simultaneously administer a β -lactamase inhibitor with a β -lactam antibiotic.

Metabolic transformation is sometimes required to convert an inactive drug precursor, or **prodrug**, into its biologically active form (see [Chapter 47](#)). 2'-Deoxy-5-fluorouridylic acid, a potent inhibitor of thymidylate synthase, a common target of cancer chemotherapy, is produced from 5-fluorouracil via a series of enzymatic transformations catalyzed by a phosphoribosyl transferase and the enzymes of the deoxyribonucleoside salvage pathway (see [Chapter 33](#)). The effective design and administration of prodrugs requires knowledge of the kinetics and mechanisms of the enzymes responsible for transforming them into their biologically active forms.

SUMMARY

- The study of enzyme kinetics—the factors that affect the rates of enzyme-catalyzed reactions—reveals the individual steps by which enzymes transform substrates into products.

- ΔG , the overall change in free energy for a reaction, is independent of reaction mechanism and provides no information concerning *rates* of reactions.
- K_{eq} , a ratio of reaction *rate constants*, may be calculated from the concentrations of substrates and products at equilibrium or from the ratio k_1/k_{-1} . Enzymes do *not* affect K_{eq} .
- Reactions proceed via transition states, for whose formation the activation energy is referred to as ΔG_{F} . Temperature, hydrogen ion concentration, enzyme concentration, substrate concentration, and inhibitors all affect the rates of enzyme-catalyzed reactions.
- Measurement of the rate of an enzyme-catalyzed reaction generally employs initial rate conditions, for which the virtual absence of product effectively precludes the reverse reaction from taking place.
- Linear forms of the Michaelis-Menten equation simplify determination of K_{m} and V_{max} .
- A linear form of the Hill equation is used to evaluate the cooperative substrate-binding kinetics exhibited by some multimeric enzymes. The slope n , the Hill coefficient, reflects the number, nature, and strength of the interactions of the substrate-binding sites. A value of n greater than 1 indicates positive cooperativity.
- The effects of simple competitive inhibitors, which typically resemble substrates, are overcome by raising the concentration of the substrate. Simple noncompetitive inhibitors lower V_{max} but do not affect K_{m} .
- For simple competitive and noncompetitive inhibitors, the inhibitory constant K_{i} is equal to the dissociation constant for the relevant enzyme-inhibitor complex. A simpler and less rigorous term widely used in pharmaceutical publications for evaluating the effectiveness of an inhibitor is IC_{50} , the concentration of inhibitor that produces 50% inhibition under the particular circumstances of an experiment.
- Substrates may add in a random order (either substrate may combine first with the enzyme) or in a compulsory order (substrate A must bind before substrate B).
- In ping-pong reactions, one or more products are released from the enzyme before all the substrates have been added.
- Applied enzyme kinetics facilitate the identification, characterization, and elucidation of the mode of action of drugs that selectively inhibit specific enzymes.
- Enzyme kinetics plays a central role in the analysis and optimization

of drug metabolism, a key determinant of drug efficacy.

REFERENCES

- Cook PF, Cleland WW: *Enzyme Kinetics and Mechanism*. Garland Science, 2007.
- Copeland RA: *Evaluation of Enzyme Inhibitors in Drug Discovery*. John Wiley & Sons, 2005.
- Cornish-Bowden A: *Fundamentals of Enzyme Kinetics*. Portland Press Ltd, 2004.
- Dixon M: The graphical determination of K_m and K_i . *Biochem J* 1972;129:197.
- Fersht A: *Structure and Mechanism in Protein Science: A Guide to Enzyme Catalysis and Protein Folding*. Freeman, 1999.
- Schramm, VL: Enzymatic transition-state theory and transition-state analogue design. *J Biol Chem* 2007;282:28297.
- Segel IH: *Enzyme Kinetics*. Wiley Interscience, 1975.
- Wlodawer A: Rational approach to AIDS drug design through structural biology. *Annu Rev Med* 2002;53:595.

Enzymes: Regulation of Activities

Peter J. Kennelly, PhD & Victor W. Rodwell, PhD

OBJECTIVES

After studying this chapter, you should be able to:

- Explain the concept of whole-body homeostasis.
- Discuss why the cellular concentrations of substrates for most enzymes tend to be close to K_m .
- List multiple mechanisms by which active control of metabolite flux is achieved.
- State the advantages of synthesizing certain enzymes as proenzymes.
- Describe typical structural changes that accompany conversion of a proenzyme to its active form.
- Indicate two general ways in which an allosteric effector can influence catalytic activity.
- Outline the roles of protein kinases, protein phosphatases, and of regulatory and hormonal and second messengers in regulating metabolic processes.
- Explain how the substrate requirements of lysine acetyltransferases and sirtuins can trigger shifts in the degree of

lysine acetylation of metabolic enzymes.

- Describe two ways by which regulatory networks can be constructed in cells.

BIOMEDICAL IMPORTANCE

The 19th-century physiologist Claude Bernard enunciated the conceptual basis for metabolic regulation. He observed that living organisms respond in ways that are both quantitatively and temporally appropriate to permit them to survive the multiple challenges posed by changes in their external and internal environments. Walter Cannon subsequently coined the term “homeostasis” to describe the ability of animals to maintain a constant internal environment despite changes in their external surroundings. At the cellular level, homeostasis is maintained by adjusting the rates of key metabolic reactions in response to internal changes. Examples include the levels of key metabolic intermediates such as 5'-AMP and NAD⁺, or external factors such as hormones acting through receptor-controlled signal transduction cascades.

Perturbations of the sensor-response machinery responsible for maintaining homeostatic balance can be deleterious to human health. Cancer, diabetes, cystic fibrosis, and Alzheimer disease, for example, are all characterized by regulatory dysfunctions triggered by the interplay between pathogenic agents, genetic mutations, nutritional inputs, and lifestyle practices. For example, many oncogenic viruses contribute to the initiation of cancer by elaborating protein-tyrosine kinases that modify proteins responsible for controlling patterns of gene expression. The cholera toxin produced by *Vibrio cholerae* disables sensor-response pathways in intestinal epithelial cells by catalyzing the addition of ADP-ribose to the GTP-binding proteins (G-proteins) that link cell-surface receptors to adenylyl cyclase. The ADP-ribose induced activation of the cyclase leads to the unrestricted flow of water into the intestines, resulting in massive diarrhea and dehydration. *Yersinia pestis*, the causative agent of plague, elaborates a protein-tyrosine phosphatase that hydrolyzes phosphoryl groups on key cytoskeletal proteins, thereby disabling the phagocytic machinery of protective macrophages. Dysfunctions in the proteolytic systems responsible for the degradation of defective or abnormal proteins are believed to play a role in neurodegenerative diseases such as Alzheimer and Parkinson.

In addition to their immediate function as regulators of enzyme activity,

protein degradation, etc, covalent modifications such as phosphorylation, acetylation, and ubiquitination provide a protein-based code for the storage and transmission of information (see [Chapter 35](#)). Such DNA-independent hereditary information is referred to as **epigenetic**. Knowledge of factors that control the rates of enzyme-catalyzed reactions thus is essential to an understanding of the molecular basis of disease and its transmission. This chapter outlines the mechanisms by which metabolic processes are controlled, and provides illustrative examples. Subsequent chapters provide additional examples.

REGULATION OF METABOLITE FLOW CAN BE ACTIVE OR PASSIVE

Enzymes that operate at their maximal rate cannot increase throughput to accommodate surges in substrate availability, and will reduce their output of product only if substrate concentration decreases precipitously. The K_m values for most enzymes, therefore, tend to be close to the average intracellular concentration of their substrates, so that changes in substrate concentration generate corresponding changes in metabolite flux ([Figure 9-1](#)). Responses to changes in substrate level represent an important but *passive* means for coordinating metabolite flow. The mechanisms that regulate enzyme efficiency in an *active* manner in response to internal and external signals are discussed below.

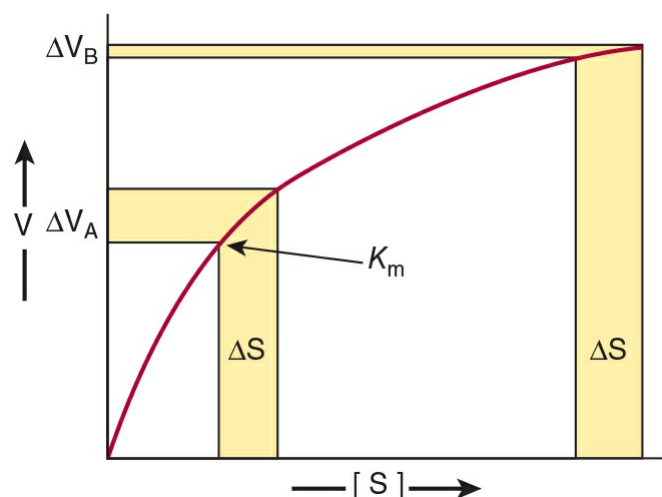

FIGURE 9-1 Differential response of the rate of an enzyme-catalyzed reaction, ΔV , to the same incremental change in substrate concentration at a substrate concentration close to K_m (ΔV_A) or far above K_m (ΔV_B).

Metabolite Flow Tends to Be Unidirectional

Despite the existence of short-term oscillations in metabolite concentrations and enzyme levels, living cells exist in a dynamic steady state in which the mean concentrations of metabolic intermediates remain relatively constant over time. While all chemical reactions are to some extent reversible, in living cells the reaction products of one enzyme-catalyzed reaction serve as substrates for, and are removed by, other enzyme-catalyzed reactions (**Figure 9–2**). Under these circumstances many nominally reversible reactions occur unidirectionally. This succession of coupled enzyme-catalyzed reactions is accompanied by an *overall* change in free energy that favors unidirectional metabolite flow analogous to the flow of water through a pipe in which one end is lower than the other. Flow of water through the pipe remains unidirectional despite the presence of bends or kinks, which simulate steps with a small or even an unfavorable change in free energy, due to the overall change in height, which corresponds to the pathway's overall change in free energy (**Figure 9–3**).

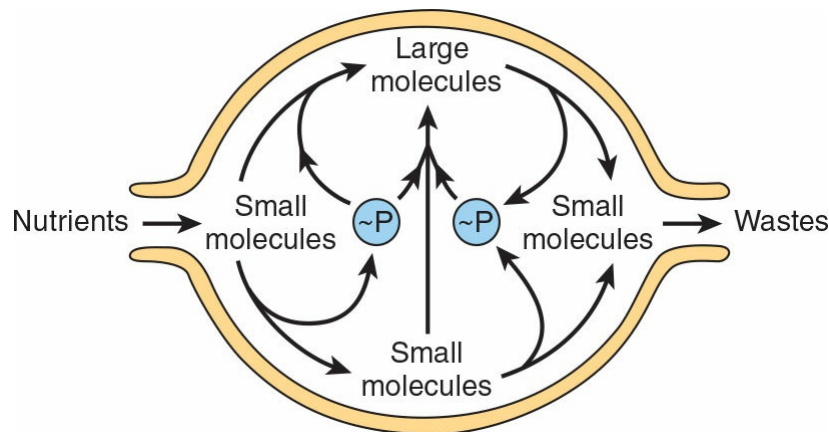

FIGURE 9–2 An idealized cell in steady state. Note that metabolite flow is unidirectional.

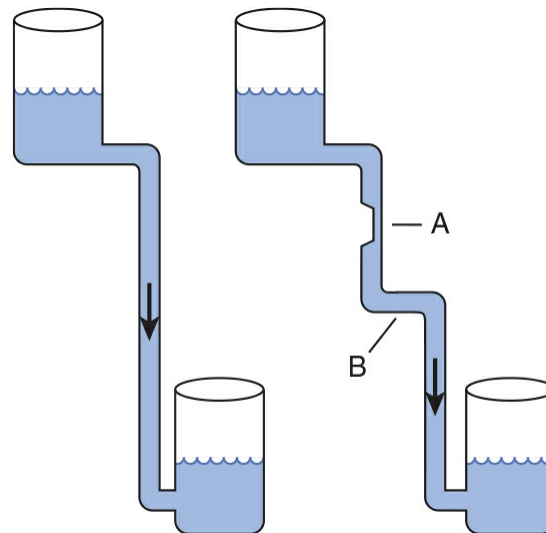

FIGURE 9–3 Hydrostatic analogy for a pathway with a rate-limiting step (A) and a step with a ΔG value near 0 (B).

COMPARTMENTATION ENSURES METABOLIC EFFICIENCY & SIMPLIFIES REGULATION

In eukaryotes, the anabolic and catabolic pathways that synthesize and break down common biomolecules often are physically separated from one another. Certain metabolic pathways reside only within specialized cell types or inside separate subcellular compartments. For example, fatty acid biosynthesis occurs in the cytosol, whereas fatty acid oxidation takes place within mitochondria (see [Chapters 22](#) and [23](#)), while many degradative enzymes are contained inside organelles called lysosomes. In addition, apparently antagonistic pathways can coexist in the absence of physical barriers provided that thermodynamics dictates that each proceeds with the formation of one or more *unique intermediates*. For any reaction or series of reactions, the change in free energy that takes place when metabolite flow proceeds in the “forward” direction is equal in magnitude *but opposite in sign* from that required to proceed in the “reverse” direction. Some enzymes within these pathways catalyze reactions, such as isomerizations, for which the difference in free energy between substrates and products is close to zero. These catalysts act bidirectionally, depending on the ratio of substrates to products. However, virtually all metabolic pathways possess one or more steps for which ΔG is significant. For example, glycolysis, the breakdown of glucose to form two molecules of pyruvate, has a favorable overall ΔG of -96 kJ/mol, a value much too large to simply operate in “reverse” in order to convert excess pyruvate to glucose. Consequently, gluconeogenesis proceeds via a pathway in which

the three most energetically disfavored steps in glycolysis are circumvented using alternative, thermodynamically favorable reactions catalyzed by distinct enzymes (see [Chapter 19](#)).

The ability of enzymes to discriminate between the structurally similar coenzymes NAD^+ and NADP^+ also results in a form of compartmentation. The reduction potentials of both coenzymes are similar. However, most of the reactions that generate electrons destined for the electron transport chain reduce NAD^+ , while enzymes that catalyze the reductive steps in many biosynthetic pathways generally use NADPH as the electron donor.

Rate-Limiting Enzymes as Preferred Targets of Regulatory Control

While the flux of metabolites through metabolic pathways involves catalysis by numerous enzymes, active control of homeostasis is achieved by the regulation of only a select subset of these enzymes. The ideal enzyme for regulatory intervention is one whose quantity or catalytic efficiency dictates that the reaction it catalyzes is slow relative to all others in the pathway. Decreasing the catalytic efficiency or the quantity of the catalyst participating in the “bottleneck” or **rate-limiting reaction** will immediately reduce metabolite flux through the entire pathway.

Conversely, an increase in either its quantity or catalytic efficiency will elicit an increase in flux through the pathway as a whole. As natural “governors” of metabolic flux, the enzymes that catalyze rate-limiting steps also constitute promising drug targets. For example, “statin” drugs curtail synthesis of cholesterol by inhibiting HMG-CoA reductase, catalyst of the rate-limiting reaction of cholesterologenesis.

REGULATION OF ENZYME QUANTITY

The overall catalytic capacity of the rate-limiting step in a metabolic pathway is the product of the concentration of enzyme molecules and their intrinsic catalytic efficiency. It therefore follows that catalytic capacity can be controlled by changing the quantity of enzyme present, altering its intrinsic catalytic efficiency, or a combination thereof.

Proteins Are Continuously Synthesized and Degraded

By measuring the rates of incorporation and subsequent loss of ^{15}N -labeled amino acids into proteins, Schoenheimer deduced that proteins

exist in a state of “dynamic equilibrium” where they are continuously synthesized and degraded—a process referred to as **protein turnover**. Even **constitutive** proteins, those whose aggregate concentrations remain essentially constant over time, are subject to continual turnover. However, the concentrations of many other enzymes are subject to dynamic shifts in response to hormonal, dietary, pathologic, and other factors that may affect the overall rate constants for their synthesis (k_s), degradation (k_{deg}), or both.

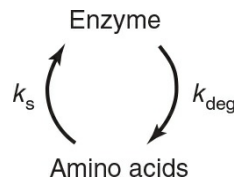

Control of Enzyme Synthesis

The synthesis of certain enzymes depends on the presence of **inducers**, typically substrates or structurally related compounds that stimulate the transcription of the gene that encodes them (see [Chapters 36](#) and [37](#)), or **transcription factors**. *Escherichia coli* grown on glucose will, for example, only catabolize lactose after addition of a β -galactoside, an inducer that triggers synthesis of a β -galactosidase and a galactoside permease. Inducible enzymes of humans include tryptophan pyrrolase, threonine dehydratase, tyrosine- α -ketoglutarate aminotransferase, enzymes of the urea cycle, HMG-CoA reductase, Δ -aminolevulinate synthase, and cytochrome P450. Conversely, an excess of a metabolite may curtail synthesis of its cognate enzyme via **repression**. Both induction and repression involve *cis* elements, specific DNA sequences located upstream of regulated genes, and *trans*-acting regulatory proteins. The molecular mechanisms of induction and repression are discussed in [Chapter 38](#). The activity of transcription factors, on the other hand, is controlled by the hormones and other extracellular signals and their corresponding cell receptors. Detailed information on the control of protein synthesis in response to hormonal stimuli can be found in [Chapter 42](#).

Control of Enzyme Degradation

In animals many proteins are degraded by the ubiquitin-proteasome pathway. Degradation takes place in the 26S proteasome, a large macromolecular complex made up of more than 30 polypeptide subunits arranged in the form of a hollow cylinder. The active sites of its proteolytic

subunits face the interior of the cylinder, thus preventing indiscriminate degradation of cellular proteins. Proteins are targeted to the interior of the proteasome by the covalent attachment of one or more molecules of ubiquitin, a small, approximately 8.5-kDa protein that is highly conserved among eukaryotes. “Ubiquitination” is catalyzed by a large family of enzymes called E3 ligases, which attach ubiquitin to the side-chain amino group of lysyl residues on their targets.

The ubiquitin-proteasome pathway is responsible both for the regulated degradation of selected cellular proteins, for example, cyclins (see [Chapter 35](#)), and for the removal of defective or aberrant protein species. The key to the versatility and selectivity of the ubiquitin-proteasome system resides in the variety of intracellular E3 ligases and their ability to discriminate between the different physical or conformational states of target proteins. Thus, the ubiquitin-proteasome pathway can selectively degrade proteins whose physical integrity and functional competency have been compromised by the loss of or damage to a prosthetic group, oxidation of cysteine or histidine residues, partial unfolding, or deamidation of asparagine or glutamine residues (see [Chapter 58](#)). Recognition by proteolytic enzymes also can be regulated by covalent modifications such as phosphorylation; binding of substrates or allosteric effectors; or association with membranes, oligonucleotides, or other proteins. Dysfunctions of the ubiquitin-proteasome pathway sometimes contribute to the accumulation and subsequent aggregation of misfolded proteins characteristic of several neurodegenerative diseases.

MULTIPLE OPTIONS ARE AVAILABLE FOR REGULATING CATALYTIC ACTIVITY

In humans the induction of protein synthesis is a complex multistep process that typically requires hours to produce significant changes in overall enzyme level. By contrast, changes in intrinsic catalytic efficiency triggered by binding of dissociable ligands (**allosteric regulation**) or by **covalent modification** occur within fractions of seconds. Consequently, changes in protein level generally dominate when meeting long-term adaptive requirements, whereas changes in catalytic efficiency are favored for rapid and transient alterations in metabolite flux.

ALLOSTERIC EFFECTORS REGULATE CERTAIN ENZYMES

The governing principle of allosteric regulation is that the properties of the enzyme-effector complex differ from those of the separated enzyme and effector. In some cases, the end product of a multistep biosynthetic pathway binds to and inhibits an enzyme catalyzing one of the early steps in that pathway, a process referred to as feedback regulation. In most cases, feedback inhibitors bind to the enzyme that catalyzes the first committed step in a particular biosynthetic sequence. In the following example, the biosynthesis of D from A is catalyzed by enzymes Enz₁ through Enz₃:

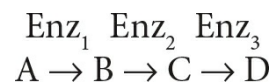

In the absence of regulatory control, if the cell no longer needs metabolite D it will continue to accumulate it until equilibrium is reached. The resulting accumulation of C will in turn cause B to accumulate. Feedback inhibition provides an alternative to simply allowing the pathway to back up like a freeway at rush hour by having D bind to Enz₁ and inhibit the conversion of A to B. In this example, D acts as a **negative allosteric effector** of Enz₁. Generally, a feedback inhibitor such as D binds at an **allosteric site**, one spatially distinct from the catalytic site of the target enzyme. Feedback inhibitors thus typically bear little or no structural similarity to the substrates, for example, “A,” of the enzymes they inhibit. For example, NAD⁺ and 3-phosphoglycerate, the substrates for 3-phosphoglycerate dehydrogenase, which catalyzes the first committed step in serine biosynthesis, bear no resemblance to the feedback inhibitor serine. In branched biosynthetic pathways, such as those responsible for nucleotide biosynthesis (see [Chapter 33](#)), the initial reactions supply intermediates required for the synthesis of multiple end products. **Figure 9–4** shows a hypothetical branched biosynthetic pathway in which curved arrows lead from feedback inhibitors to the enzymes whose activity they inhibit. The sequences S₃ → A, S₄ → B, S₄ → C, and S₃ → → D represent linear reaction sequences that are feedback inhibited by their end products. Branch point enzymes thus can be targeted to direct later stages of metabolite flow.

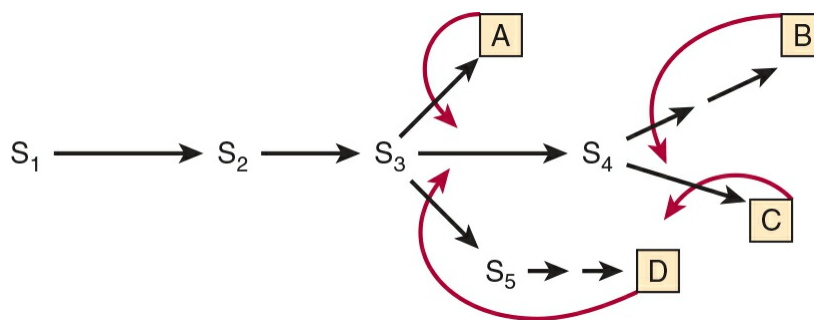

FIGURE 9–4 Sites of feedback inhibition in a branched biosynthetic pathway. S_1 to S_5 are intermediates in the biosynthesis of end products A to D. Straight arrows represent enzymes catalyzing the indicated conversions. Curved red arrows represent feedback loops and indicate sites of feedback inhibition by specific end products.

The kinetics of feedback inhibition may be competitive, noncompetitive, partially competitive, or mixed. Layering multiple feedback loops can provide additional fine control. For example, as shown in [Figure 9–5](#), the presence of excess product B decreases the requirement for substrate S_2 . However, S_2 is also required for synthesis of A, C, and D. Therefore, for this pathway, excess B curtails synthesis of all four end products, regardless of the need for the other three. To circumvent this potential difficulty, each end product may only *partially* inhibit catalytic activity. The inhibitory effect of two or more end products in excess may be strictly additive or, alternatively, greater than their individual effect (cooperative feedback inhibition). Alternatively, in the branched pathway responsible for the synthesis of the aromatic amino acids phenylalanine, tyrosine, and tryptophan in bacteria, multiple isoforms of an enzyme evolved, each of which is sensitive to a different pathway end product. High levels of any one end product will inhibit catalysis by only a single isoform, reducing, but not eliminating, flux through the shared portion of the pathway.

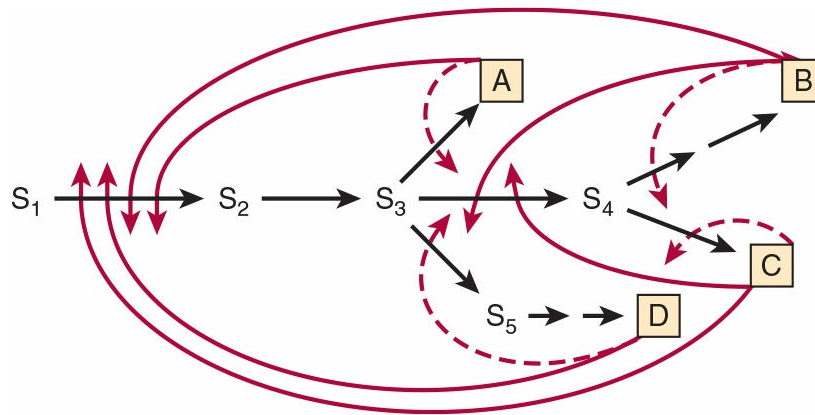

FIGURE 9–5 Multiple feedback inhibition in a branched biosynthetic pathway. Superimposed on simple feedback loops (dashed red arrows) are multiple feedback loops (solid red arrows) that regulate enzymes common to biosynthesis of several end products.

Aspartate Transcarbamoylase Is a Model Allosteric Enzyme

Aspartate transcarbamoylase (ATCase), the catalyst for the first reaction unique to pyrimidine biosynthesis (see [Figure 33–9](#)), is a target of feedback regulation by two nucleotide triphosphates: cytidine triphosphate (CTP) and adenosine triphosphate. CTP, an end product of the pyrimidine biosynthetic pathway, inhibits ATCase, whereas the purine nucleotide ATP activates it. Moreover, high levels of ATP can overcome inhibition by CTP, enabling synthesis of *pyrimidine* nucleotides to proceed when *purine* nucleotide levels are elevated.

Allosteric & Catalytic Sites Are Spatially Distinct

Jacques Monod proposed the existence of allosteric sites that are physically distinct from the catalytic site. He reasoned that the lack of structural similarity between most feedback inhibitors and the substrate(s) for the enzymes whose activities they regulate indicated that these effectors are not **isosteric** with a substrate but **allosteric** (“occupy another space”). Allosteric enzymes thus are those for which catalysis at the active site may be modulated by the presence of effectors at an allosteric site. The existence of spatially distinct active and allosteric sites has since been verified in several enzymes using many lines of evidence. For example, x-ray crystallography revealed that the ATCase of *E coli* consists of six catalytic subunits and six regulatory subunits, the latter of which bind the nucleotide

triphosphates that modulate activity. In general, binding of an allosteric regulator influences catalysis by inducing a conformational change that encompasses the active site.

Allosteric Effects May Be on K_m or on V_{max}

To refer to the kinetics of allosteric inhibition as “competitive” or “noncompetitive” with substrate carries misleading mechanistic implications. We refer instead to two classes of allosterically regulated enzymes: K-series and V-series enzymes. For K-series allosteric enzymes, the substrate saturation kinetics is competitive in the sense that K_m is raised without an effect on V_{max} . For V-series allosteric enzymes, the allosteric inhibitor lowers V_{max} without affecting the K_m . Alterations in K_m or V_{max} often are the product of conformational changes at the catalytic site induced by binding of the allosteric effector at its site. For a K-series allosteric enzyme, this conformational change may weaken the bonds between substrate and substrate-binding residues. For a V-series allosteric enzyme, the primary effect may be to alter the orientation or charge of catalytic residues, lowering V_{max} . Intermediate effects on K_m and V_{max} , however, may be observed consequent to these conformational changes.

FEEDBACK REGULATION CAN BE EITHER STIMULATORY OR INHIBITORY

In both mammalian and bacterial cells, some pathway end products “feed back” to control their own synthesis, in many instances by feedback inhibition of an early biosynthetic enzyme. We must, however, distinguish between **feedback regulation**, a phenomenologic term devoid of mechanistic implications, and **feedback inhibition**, a mechanism for regulation of enzyme activity. For example, while dietary cholesterol decreases hepatic synthesis of cholesterol, this feedback **regulation** does not involve feedback **inhibition**. HMG-CoA reductase, the rate-limiting enzyme of cholesterologenesis, is affected, but cholesterol does not inhibit its activity. Rather, regulation in response to dietary cholesterol involves curtailment by cholesterol or a cholesterol metabolite of the expression of the gene that encodes HMG-CoA reductase (enzyme repression) (see [Chapter 26](#)). As mentioned above, ATP, a product of the purine nucleotide pathway, stimulates the synthesis of pyrimidine nucleotides by activating

aspartate transcarbamoylase, a process sometimes referred to as “feed forward” regulation.

MANY HORMONES ACT VIA SECOND MESSENGERS

Nerve impulses and the binding of many hormones to cell surface receptors elicit changes in the rate of enzyme-catalyzed reactions within target cells by inducing the release or synthesis of specialized allosteric effectors called **second messengers**. The primary, or “first,” messenger is the hormone molecule or nerve impulse. Second messengers include 3', 5'-cAMP, synthesized from ATP by the enzyme adenylyl cyclase in response to the hormone epinephrine, and Ca^{2+} , which is stored inside the endoplasmic reticulum of most cells. Membrane depolarization resulting from a nerve impulse opens a membrane channel that releases calcium ions into the cytoplasm, where they bind to and activate enzymes involved in the regulation of muscle contraction and the mobilization of stored glucose from glycogen to supply the increased energy demands of muscle contraction. Other second messengers include 3',5'-cGMP, nitric oxide, and the polyphosphoinositols produced by the hydrolysis of inositol phospholipids by hormone-regulated phospholipases. Specific examples of the participation of second messengers in the regulation of cellular processes can be found in [Chapters 18, 42, and 50](#).

REGULATORY COVALENT MODIFICATIONS CAN BE REVERSIBLE OR IRREVERSIBLE

In mammalian cells, a wide range of regulatory covalent modifications occur. **Partial proteolysis** and **phosphorylation**, for example, are frequently employed to regulate the catalytic activity of enzymes. On the other hand, histones and other DNA-binding proteins in chromatin are subject to extensive modification by **acetylation, methylation, ADP-ribosylation**, as well as phosphorylation. The latter modifications, which modulate the manner in which the proteins within chromatin interact with each other as well as the DNA itself, constitute the basis for the “histone code.” The resulting changes in chromatin structure within the region affected can render genes more accessible to the proteins responsible for their transcription, thereby enhancing gene expression or, on a larger scale, facilitating replication of the entire genome (see [Chapter 38](#)). On the other hand, changes in chromatin structure that restrict the accessibility of genes

to transcription factors, DNA-dependent RNA polymerases, etc, thereby inhibiting transcription, are said to **silence** gene expression.

The Histone Code

The “histone code” represents a classic example of **epigenetics**, the hereditary transmission of information by a means other than the sequence of nucleotides that comprise the genome. In this instance, the pattern of gene expression within a newly formed “daughter” cell will be determined, in part, by the particular set of histone covalent modifications embodied in the chromatin proteins inherited from the “parental” cell.

Reversible Covalent Modification

Acetylation, ADP-ribosylation, methylation, and phosphorylation are all examples of “reversible” covalent modifications. In this context, reversible refers to the fact that the modified protein can be restored to its original, modification-free state, not the mechanism by which restoration takes place. Thermodynamics dictates that if the enzyme-catalyzed reaction by which the modification was introduced is thermodynamically favorable, simply reversing the process will be rendered impractical by the correspondingly unfavorable free-energy change. The phosphorylation of proteins on seryl, threonyl, or tyrosyl residues, catalyzed by protein kinases, is thermodynamically favored as a consequence of utilizing the high-energy gamma phosphoryl group of ATP. Phosphate groups are removed, not by recombining the phosphate with ADP to form ATP, but by a hydrolytic reaction catalyzed by enzymes called protein phosphatases. Similarly, acetyltransferases employ a high-energy donor substrate, NAD^+ , while deacetylases catalyze a direct hydrolysis that generates free acetate.

PROTEASES MAY BE SECRETED AS CATALYTICALLY INACTIVE PROENZYMES

Certain proteins are synthesized as inactive precursor proteins known as **proproteins**. Selective, or “partial,” proteolysis of a proprotein by one or more successive proteolytic “clips” converts it to a form that exhibits the characteristic activity of the mature protein, for example, its catalytic activity. The proprotein forms of enzymes are termed **proenzymes** or **zymogens**. Proteins synthesized as proproteins include the hormone

insulin (proprotein = proinsulin), the digestive enzymes pepsin, trypsin, and chymotrypsin (proproteins = pepsinogen, trypsinogen, and chymotrypsinogen, respectively), several factors of the blood clotting and complement cascades (see [Chapters 52](#) and [55](#)), and the connective tissue protein collagen (proprotein = procollagen).

Proteolytic activation of proproteins constitutes a physiologically irreversible modification because reunification of the two portions of a protein produced by hydrolysis of a peptide bond is entropically disfavored. Once a proprotein is activated, it will continue to carry out its catalytic or other functions until it is removed by degradation or some other means. Zymogen activation thus represents a simple and economical, albeit one way, mechanism for restraining the latent activity of a protein until the appropriate circumstances are encountered. It is therefore not surprising that partial proteolysis is employed frequently to regulate proteins that work in the gastrointestinal tract or bloodstream rather than in the interior of cells.

Proenzymes Facilitate Rapid Mobilization of an Activity in Response to Physiologic Demand

Certain physiologic processes such as digestion, blood clot formation, and tissue remodeling take place on an intermittent, but relatively frequent, basis. Each of these processes makes extensive use of proteases, which are synthesized as catalytically inactive proenzymes to protect tissues from their degradative effects. In pancreatitis, premature activation of digestive proteases such as trypsinogen and chymotrypsinogen leads to autodigestion of healthy tissue rather than ingested proteins. Blood clot formation, clot dissolution, and tissue repair are brought “on line” only in response to pressing physiologic or pathophysiologic need. Zymogens offer a ready, rapidly activated source of clotting proteins when synthesis is insufficiently rapid to respond to a pressing pathophysiologic demand such as the loss of blood (see [Chapter 55](#)). However, in order to prevent clot formation from spreading beyond the site of injury, the processes of blood clot formation and dissolution clearly must be temporally coordinated.

Activation of Prochymotrypsin Requires Selective Proteolysis

Selective proteolysis involves one or more highly specific proteolytic clips

that may or may not be accompanied by separation of the resulting peptides, but generally trigger conformational changes. For example, in α -chymotrypsin, the catalytically essential residues His 57 and Asp 102 reside on the B peptide while Ser 195 resides on the C peptide (Figure 9–6). The hydrolysis of key peptide bonds in chymotrypsinogen triggers conformational changes that align these three residues of the charge-relay network (see Figure 7–7), forming the catalytic site. Note also that contact and catalytic residues can be located on different peptide chains but still be within bond-forming distance of bound substrate.

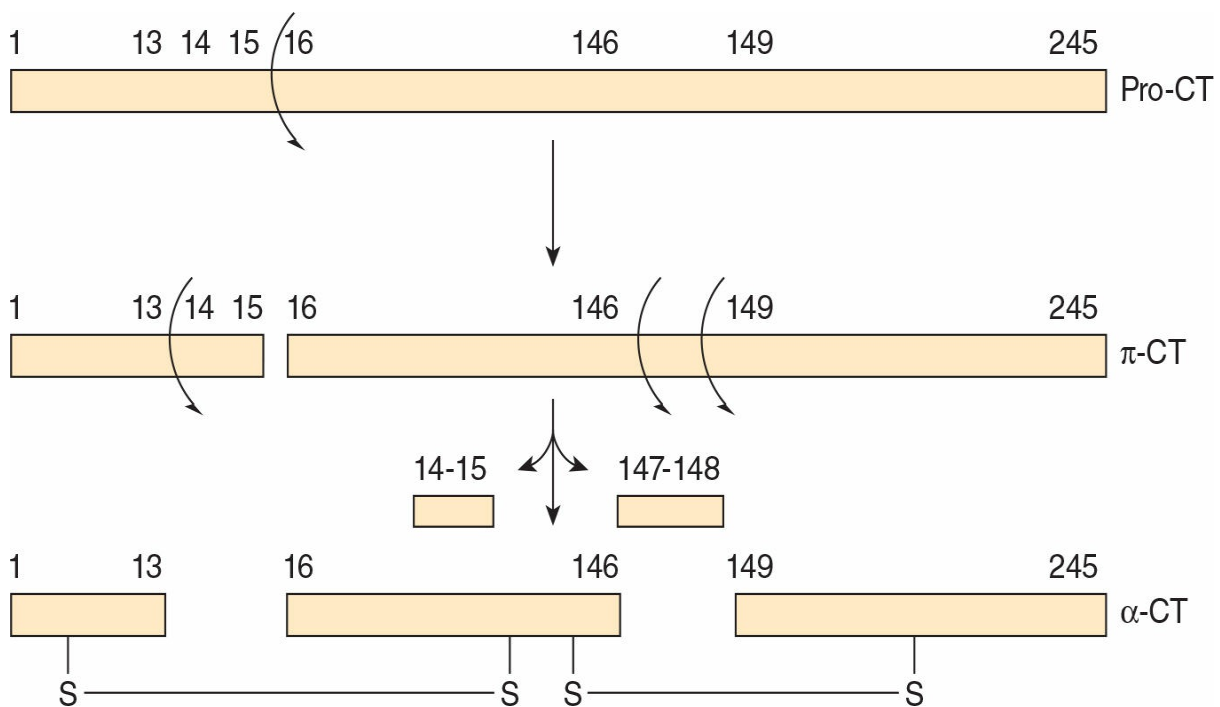

FIGURE 9–6 Two-dimensional representation of the sequence of proteolytic events that ultimately result in formation of the catalytic site of chymotrypsin, which includes the Asp102-His57-Ser195 catalytic triad (see Figure 7–7). Successive proteolysis forms prochymotrypsin (pro-CT), π -chymotrypsin (π -Ct), and ultimately α -chymotrypsin (α -CT), an active protease whose three peptides (A, B, C) remain associated by covalent interchain disulfide bonds.

REVERSIBLE COVALENT MODIFICATION REGULATES KEY MAMMALIAN PROTEINS

Thousands of Mammalian Proteins Are Modified by Covalent Phosphorylation

Mammalian proteins are the targets of a wide range of covalent modification processes. Modifications such as prenylation, glycosylation, hydroxylation, and fatty acid acylation introduce unique structural features into newly synthesized proteins that persist for the lifetime of the protein. Some covalent modifications regulate protein function. The most common ones by far are phosphorylation-dephosphorylation and acetylation-deacetylation. **Protein kinases** phosphorylate proteins by catalyzing transfer of the terminal phosphoryl group of ATP to the hydroxyl groups of seryl, threonyl, or tyrosyl residues, forming *O*-phosphoseryl, *O*-phosphothreonyl, or *O*-phosphotyrosyl residues, respectively (**Figure 9–7**). The unmodified form of the protein can be regenerated by hydrolytic removal of phosphoryl groups, a thermodynamically favorable reaction catalyzed by **protein phosphatases**.

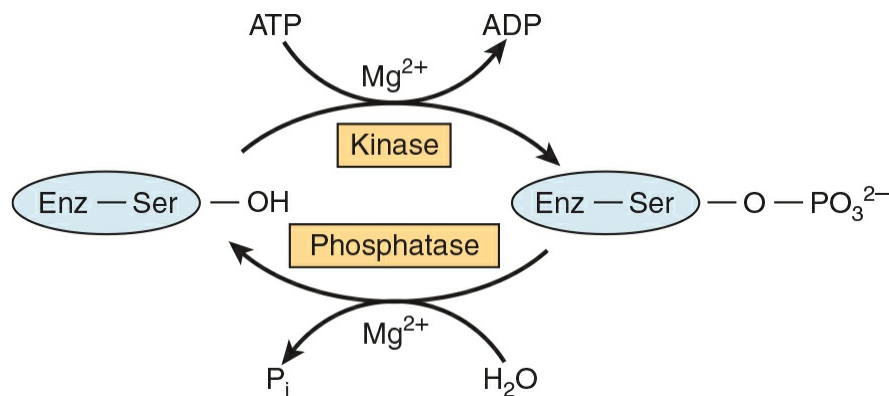

FIGURE 9–7 Covalent modification of a regulated enzyme by phosphorylation-dephosphorylation of a seryl residue.

A typical mammalian cell possesses thousands of phosphorylated proteins and several hundred protein kinases and protein phosphatases that catalyze their interconversion. The ease of interconversion of enzymes between their phospho- and dephospho- forms accounts, in part, for the frequency with which phosphorylation-dephosphorylation is utilized as a mechanism for regulatory control. Unlike structural modifications, covalent phosphorylation persists only as long as the affected functional properties of the modified protein serve a specific need. Once the need has passed, the enzyme can be converted back to its original form, poised to respond to the next stimulatory event. A second factor underlying the widespread use of protein phosphorylation-dephosphorylation lies in the chemical properties of the phosphoryl group itself. In order to alter an enzyme's functional properties, any modification of its chemical structure must influence the protein's three-dimensional configuration. The high

charge density of protein-bound phosphoryl groups, generally -2 at physiologic pH, their propensity to form strong salt bridges with arginyl and lysyl residues, and their high exceptional hydrogen-bonding capacity renders them potent agents for modifying protein structure and function. Phosphorylation generally influences an enzyme's intrinsic catalytic efficiency or other properties by inducing conformational changes. Consequently, the amino acids modified by phosphorylation can be and typically are relatively distant from the catalytic site itself.

Protein Acetylation: A Ubiquitous Modification of Metabolic Enzymes

Covalent acetylation-deacetylation has long been associated with histones and other nuclear proteins. In recent years, however, proteomic studies have revealed that thousands of other mammalian proteins are subject to modification by covalent acetylation, including nearly every enzyme in such core metabolic pathways as glycolysis, glycogen synthesis, gluconeogenesis, the tricarboxylic acid cycle, β -oxidation of fatty acids, and the urea cycle. The potential regulatory impact of acetylation-deacetylation has been established for only a handful of these proteins. However, they include many metabolically important enzymes, such as acetyl-CoA synthetase, long-chain acyl-CoA dehydrogenase, malate dehydrogenase, isocitrate dehydrogenase, glutamate dehydrogenase, carbamoyl phosphate synthetase, and ornithine transcarbamoylase.

Lysine acetyltransferases catalyze the transfer of the acetyl group of acetyl-CoA to the ϵ -amino groups of lysyl residues, forming *N*-acetyl lysine. In addition, some proteins, particularly those in the mitochondria, become acetylated by reacting with acetyl-CoA directly, that is, without the intervention of an enzyme catalyst. Acetylation not only increases the steric bulk of the lysine side chain, it transforms a basic and potentially positively charged primary amine into a neutral, nonionizable amide. Two classes of protein deacetylases have been identified: **histone deacetylases** and **sirtuins**. Histone deacetylases catalyze the removal by hydrolysis of acetyl groups, regenerating the unmodified form of the protein and acetate as products. Sirtuins, on the other hand, use NAD^+ as substrate, which yields *O*-acetyl ADP-ribose and nicotinamide as products in addition to the unmodified protein.

Covalent Modifications Regulate Metabolite Flow

In many respects, the sites of protein phosphorylation, acetylation, and other covalent modifications can be considered another form of allosteric site. However, in this case, the “allosteric ligand” binds covalently to the protein. Phosphorylation-dephosphorylation, acetylation-deacetylation, and feedback inhibition provide short-term, readily reversible regulation of metabolite flow in response to specific physiologic signals. All three act independently of changes in gene expression. As with feedback inhibition, protein phosphorylation-dephosphorylation generally targets an early enzyme in a protracted metabolic pathway. Feedback inhibition, however, involves a single protein that is influenced indirectly, if at all, by hormonal or neural signals. By contrast, regulation of mammalian enzymes by phosphorylation-dephosphorylation involves one or more protein kinases and protein phosphatases, and is generally under direct neural and hormonal control.

Acetylation-deacetylation, on the other hand, targets multiple proteins in a pathway. It has been hypothesized that the degree of acetylation of metabolic enzymes is modulated to a large degree by the energy status of the cell. Under this model, the high levels of acetyl-CoA (the substrate for lysine acetyltransferases and the reactant in nonenzymatic lysine acetylation) present in a well-nourished cell would promote lysine acetylation. When nutrients are lacking, acetyl-CoA levels drop and the ratio of NAD^+/NADH rises, favoring protein deacetylation.

PROTEIN PHOSPHORYLATION IS EXTREMELY VERSATILE

Protein phosphorylation-dephosphorylation is a highly versatile and selective process. Not all proteins are subject to phosphorylation, and of the many hydroxyl groups on a protein’s surface, only one or a small subset are targeted. While the most common protein function affected is an enzyme’s catalytic efficiency, phosphorylation can also alter its location within the cell, susceptibility to proteolytic degradation, or responsiveness to regulation by allosteric ligands. While phosphorylation of some increases their catalytic activity, the phosphorylated form of other enzymes may be catalytically inactive (**Table 9–1**).

TABLE 9–1 Examples of Mammalian Enzymes Whose Catalytic Activity Is Altered by Covalent Phosphorylation-Dephosphorylation

Enzyme	Activity State	
	Low	High
Acetyl-CoA carboxylase	EP	E
Glycogen synthase	EP	E
Pyruvate dehydrogenase	EP	E
HMG-CoA reductase	EP	E
Glycogen phosphorylase	E	EP
Citrate lyase	E	EP
Phosphorylase b kinase	E	EP
HMG-CoA reductase kinase	E	EP

Abbreviations: E, dephosphoenzyme; EP, phosphoenzyme.

Many proteins can be phosphorylated at multiple sites. Others are subject to regulation both by phosphorylation-dephosphorylation and by the binding of allosteric ligands, or by phosphorylation-dephosphorylation and another covalent modification. Phosphorylation-dephosphorylation at any one site can be catalyzed by multiple protein kinases or protein phosphatases. Many protein kinases and most protein phosphatases act on more than one protein and are themselves interconverted between active and inactive forms by the binding of second messengers or by covalent modification by phosphorylation-dephosphorylation.

The interplay between protein kinases and protein phosphatases, between the functional consequences of phosphorylation at different sites, between phosphorylation sites and allosteric sites, or between phosphorylation sites and other sites of covalent modification provides the basis for regulatory networks that integrate multiple inputs to evoke an appropriate coordinated cellular response. In these sophisticated regulatory networks, individual enzymes respond to different internal and environmental signals. For example, if an enzyme can be phosphorylated at a single site by more than one protein kinase, it can be converted from a catalytically efficient to an inefficient (inactive) form, or vice versa, in response to any one of several signals. If the protein kinase is activated in response to a signal different from the signal that activates the protein phosphatase, the phosphoprotein becomes a *decision node*, whose functional output, generally catalytic activity, reflects its

phosphorylation state. This state or degree of phosphorylation is determined by the relative activities of the protein kinase and protein phosphatase, a reflection of the presence and relative strength of the environmental signals that act through each activity.

The ability of many protein kinases and protein phosphatases to target more than one protein provides a means for an environmental signal to coordinately regulate multiple metabolic processes. For example, the enzymes 3-hydroxy-3-methylglutaryl-CoA reductase and acetyl-CoA carboxylase—the rate-controlling enzymes for cholesterol and fatty acid biosynthesis, respectively—are phosphorylated and inactivated by the AMP-activated protein kinase. When this protein kinase is activated either through phosphorylation by yet another protein kinase or in response to the binding of its allosteric activator 5'-AMP, the two major pathways responsible for the synthesis of lipids from acetyl-CoA are both inhibited.

INDIVIDUAL REGULATORY EVENTS COMBINE TO FORM SOPHISTICATED CONTROL NETWORKS

Cells carry out a complex array of metabolic processes that must be regulated in response to a broad spectrum of internal and external factors. Hence, interconvertible enzymes and the enzymes responsible for their interconversion act, not as isolated “on” and “off” switches, but as binary elements within integrated biomolecular information processing networks.

One well-studied example of such a network is the eukaryotic cell cycle that controls cell division. Upon emergence from the G_0 or quiescent state, the extremely complex process of cell division proceeds through a series of specific phases designated G_1 , S, G_2 , and M (**Figure 9–8**). Elaborate monitoring systems, called **checkpoints**, assess key indicators of progress to ensure that no phase of the cycle is initiated until the prior phase is complete. **Figure 9–8** outlines, in simplified form, the checkpoint that controls the initiation of DNA replication, called S phase. A protein kinase called ATM is associated with the genome. ATM binds to and is activated by regions of chromatin-containing double-stranded breaks in the DNA. Upon activation, one subunit of the activated ATM dimer dissociates and initiates a series, or cascade, of protein phosphorylation-dephosphorylation events mediated by the CHK1 and CHK2 protein kinases, the Cdc25 protein phosphatase, and finally a complex between a cyclin and a cyclin-dependent protein kinase, or Cdk. Activation of the Cdk-cyclin complex

blocks the G_1 to S transition, thus preventing the replication of damaged DNA. Failure at this checkpoint can lead to mutations in DNA that may lead to cancer or other diseases. Each step in the cascade provides a conduit for monitoring additional indicators of cell status prior to entering S phase.

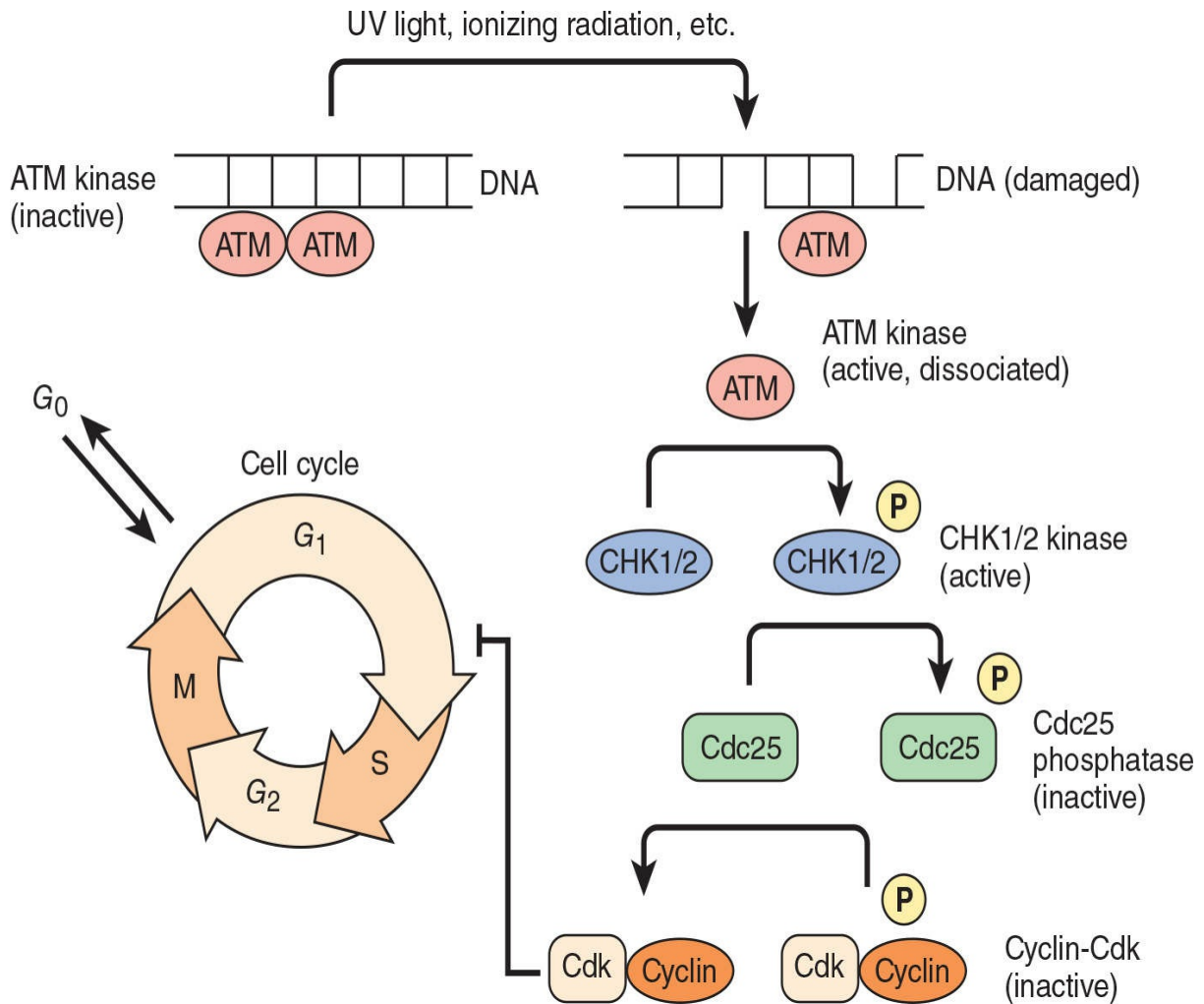

FIGURE 9–8 A simplified representation of the G_1 to S checkpoint of the eukaryotic cell cycle. The circle shows the various stages in the eukaryotic cell cycle. The genome is replicated during S phase, while the two copies of the genome are segregated and cell division occurs during M phase. Each of these phases is separated by a G , or growth, phase characterized by an increase in cell size and the accumulation of the precursors required for the assembly of the large macromolecular complexes formed during S and M phases.

SUMMARY

- Homeostasis involves maintaining a relatively constant intracellular and intraorgan environment despite wide fluctuations in the external environment. This is achieved via appropriate changes in the rates of biochemical reactions in response to physiologic need.
- The substrates for most enzymes are usually present at a concentration close to their K_m . This facilitates passive adjustments to the rates of product formation in response to changes in levels of metabolic intermediates.
- Most metabolic control mechanisms target enzymes that catalyze an early, committed, and rate-limiting reaction. Control can be exerted by varying the concentration of the target protein, its functional efficiency, or some combination of the two.
- Secretion of inactive proenzymes or zymogens facilitates rapid mobilization of activity via partial proteolysis in response to injury or physiologic need while protecting the tissue of origin (eg, autodigestion by proteases).
- Binding of metabolites and second messengers to sites distinct from the catalytic sites of enzymes triggers conformational changes that alter V_{max} or K_m .
- Phosphorylation by protein kinases of specific seryl, threonyl, or tyrosyl residues—and subsequent dephosphorylation by protein phosphatases—regulates the activity of many human enzymes in response to hormonal and neural signals.
- Numerous metabolic enzymes are modified by the acetylation-deacetylation of lysine residues. The degree of acetylation of these proteins is thought to be modulated by the availability of acetyl-CoA, the acetyl donor substrate for lysine acetyltransferases, and NAD^+ , a substrate for the sirtuin deacetylases.
- The capacity of protein kinases, protein phosphatases, lysine acetylases, and lysine deacetylases to target both multiple proteins and multiple sites on proteins is key to the formation of integrated regulatory networks that process complex environmental information to produce an appropriate cellular response.

REFERENCES

- Baeza J, Smallegan MJ, Denu JM: Mechanisms and dynamics of protein acetylation in mitochondria. *Trends Biochem Sci* 2016;41:231.
- Bett JS: Proteostasis regulation by the ubiquitin system. *Essays Biochem*

- 2016;60:143.
- Dokholyan NV: Controlling allosteric networks in proteins. *Chem Rev* 2016;116:6463.
- Elgin SC, Reuter G: In: Allis CD, Jenuwein T, Reinberg D, et al (editors): *Epigenetics*, Cold Spring Harbor Laboratory Press, 2007.
- Johnson LN, Lewis RJ: Structural basis for control by phosphorylation. *Chem Rev* 2001;101:2209.
- Muoio DM, Newgard CB: Obesity-related derangements in metabolic regulation. *Annu Rev Biochem* 2006;75:403.
- Tu BP, Kudlicki A, Rowicka M, et al: Logic of the yeast metabolic cycle: temporal compartmentalization of cellular processes. *Science* 2005;310:1152.

The Biochemical Roles of Transition Metals

Peter J. Kennelly, PhD

OBJECTIVES

After studying this chapter, you should be able to:

- Explain why essential transition metals are often referred to as micronutrients.
- Understand the importance of multivalency to the ability of transition metals to participate in electron transport and oxidation–reduction reactions.
- Understand how Lewis and Bronsted-Lowry acids differ.
- Define the term complexation as it refers to metal ions.
- Provide a rationale for why zinc is a common prosthetic group in enzymes that catalyze hydrolytic reactions.
- List four benefits obtained by incorporating transition metals into organometallic complexes *in vivo*.
- Cite examples of the ability of a given transition metal to function as an electron carrier in one protein, an oxygen carrier in another, and a redox catalyst in yet another.
- Explain how the possession of multiple metal ions enables the

metalloenzymes cytochrome oxidase and nitrogenase to catalyze the reduction of molecular oxygen and nitrogen, respectively.

- Describe two mechanisms by which excess levels of transition metals can be harmful to living organisms.
- Provide an operational definition of the term “heavy metal,” and list three strategies for treating acute heavy metal poisoning.
- Describe the processes by which Fe, Co, Cu, and Mo are absorbed in the human gastrointestinal tract.
- Describe the metabolic role of sulfite oxidase and the pathology of sulfite oxidase deficiency.
- Describe the function of zinc finger motifs and provide an example of their role in metal ion metabolism.

BIOMEDICAL IMPORTANCE

Maintenance of human health and vitality requires the ingestion of trace levels of numerous inorganic elements, among them the transition metals iron (Fe), manganese (Mn), zinc (Zn), cobalt (Co), copper (Cu), nickel (Ni), molybdenum (Mo), vanadium (V), and chromium (Cr). In general, transition metals are sequestered in organometallic complexes within our bodies, enabling their properties to be controlled and directed where needed, and their propensity to promote the generation of harmful reactive oxygen species is minimized. Transition metals are key components of numerous enzymes and electron transport proteins as well as the oxygen transport proteins hemoglobin and hemocyanin. Zinc finger motifs provide the DNA-binding domains for many transcription factors, while Fe-S clusters are found in many of the enzymes that participate in DNA replication and repair. Nutritionally or genetically induced deficiencies of these metals are associated with a variety of pathologic conditions including pernicious anemia (Fe), Menkes disease (Cu), and sulfite oxidase deficiency (Mo). When ingested in large quantities, most heavy metals, including several of the nutritionally essential transition metals, are highly toxic and nearly all are potentially carcinogenic.

TRANSITION METALS ARE ESSENTIAL FOR HEALTH

Humans Require Minute Quantities of Several

Inorganic Elements

The organic elements oxygen, carbon, hydrogen, nitrogen, sulfur, and phosphorous typically account for slightly more than 97% of the mass of the human body. Calcium, the majority of which is contained in bones, teeth, and cartilage, contributes a further $\approx 2\%$. The remaining 0.4 to 0.5% is accounted for by numerous inorganic elements (**Table 10–1**). Many of these are essential for health, albeit in minute quantities, and thus are commonly classified as **micronutrients**. Examples of physiologically essential micronutrients include iodine, which is required for the synthesis of tri- and tetraiodothyronine (see **Chapter 41**); selenium, which is required for the synthesis of the amino acid selenocysteine (see **Chapter 27**); and vitamins (see **Chapter 44**). The focus of the current chapter will be on the physiologic roles of the nutritionally essential transition metals iron (Fe), manganese (Mn), zinc (Zn), cobalt (Co), copper (Cu), nickel (Ni), molybdenum (Mo), vanadium (V), and chromium (Cr).

TABLE 10–1 Quantities of Selected Elements in the Human Body

Element	Mass	Essential	Element	Mass	Essential	Element	Mass	Essential
Oxygen	43 kg	+	Selenium	15 μg	+	Cadmium	50 μg	-
Carbon	16 kg	+	Iron	4.2 g	+	Rubidium	680 μg	-
Hydrogen	7 kg	+	Zinc	2.3 g	+	Strontium	320 μg	-
Nitrogen	1.8 kg	+	Copper	72 μg	+	Titanium	20 μg	-
Phosphorous	780 g	+	Nickel	15 μg	+	Silver	2 μg	-
Calcium	1.0 kg	+	Chromium	14 μg	+	Niobium	1.5 μg	-
Sulfur	140 g	+	Manganese	12 μg	+	Zirconium	1 μg	-
Potassium	140 g	+	Molybdenum	5 μg	+	Tungsten	20 ng	-
Sodium	100 g	+	Cobalt	3 μg	+	Yttrium	0.6 μg	-
Chlorine	95 g	+	Vanadium	0.1 μg	+	Cerium	40 μg	-
Magnesium	19 g	+	Silicon	1.0 mg	Possibly	Bromine	260 μg	-
Iodine	20 μg	+	Fluorine*	2.6 g	-	Lead*	120 μg	-

Data for a 70-kg (150 lb) human are from *Emsley, John, The Elements, 3rd ed. Clarendon Press, Oxford, 1998*. Essentiality of chromium is based on its proposed biologic role.

Transition Metals are Multivalent

One common characteristic of metals is their propensity to undergo **oxidation**, a process in which they donate one or more electrons from their outer or valence shell to an electronegative acceptor species, for example, molecular oxygen. Oxidation of an alkali or alkaline earth metal (**Figure 10–1**) results in a single ionized species, for example, Na^+ , K^+ , Li^+ , Mg^{2+} , or Ca^{2+} . By contrast, the **oxidation of transition metals** can yield **multiple valence states** (**Table 10–2**). This capability enables transition metals to undergo dynamic transitions between valence states through the addition or donation of electrons, and therefore to function as an electron carrier during oxidation–reduction (redox) reactions. That transitional metals can also act as *acids* further expanding their biologic roles.

1A 1																	8A 18
1 H	2A 2											3A 13	4A 14	5A 15	6A 16	7A 17	2 He
3 Li	4 Be											5 B	6 C	7 N	8 O	9 F	10 Ne
11 Na	12 Mg	3B 3	4B 4	5B 5	6B 6	7B 7	8B 8 9 10			1B 11	2B 12	13 Al	14 Si	15 P	16 S	17 Cl	18 Ar
19 K	20 Ca	21 Sc	22 Ti	23 V	24 Cr	25 Mn	26 Fe	27 Co	28 Ni	29 Cu	30 Zn	31 Ga	32 Ge	33 As	34 Se	35 Br	36 Kr
37 Rb	38 Sr	39 Y	40 Zr	41 Nb	42 Mo	43 Tc	44 Ru	45 Rh	46 Pd	47 Ag	48 Cd	49 In	50 Sn	51 Sb	52 Te	53 I	54 Xe
55 Cs	56 Ba	71 Lu	72 Hf	73 Ta	74 W	75 Re	76 Os	77 Ir	78 Pt	79 Au	80 Hg	81 Tl	82 Pb	83 Bi	84 Po	85 At	86 Rn
87 Fr	88 Ra	103 Lr	104 Rf	105 Db	106 Sg	107 Bh	108 Hs	109 Mt					114		116		

Metals	57 La	58 Ce	59 Pr	60 Nd	61 Pm	62 Sm	63 Eu	64 Gd	65 Tb	66 Dy	67 Ho	68 Er	69 Tm	70 Yb
Metalloids	89 Ac	90 Th	91 Pa	92 U	93 Np	94 Pu	95 Am	96 Cm	97 Bk	98 Cf	99 Es	100 Fm	101 Md	102 No
Nonmetals														

FIGURE 10–1 Periodic table of the elements. Transition metals occupy columns 3 to 11, also labeled 1B to 8B.

TABLE 10–2 Valence States of Essential Transition Metals

Transition Metal	Potential Valences
Cobalt	Co ⁻¹ , Co ⁰ , Co⁺, Co²⁺, Co³⁺ , Co ⁴⁺
Chromium	Cr ⁻⁴ , Cr ⁻² , Cr ⁻ , Cr ⁰ , Cr ⁺ , Cr ²⁺ , Cr³⁺ , Cr ⁴⁺ , Cr ⁵⁺ , Cr ⁶⁺
Copper	Cu ⁰ , Cu⁺, Cu²⁺
Iron	Fe ⁰ , Fe ⁺ , Fe²⁺, Fe³⁺, Fe⁴⁺ , Fe ⁵⁺ , Fe ⁶⁺
Manganese	Mn ³⁻ , Mn ²⁻ , Mn ⁻ , Mn ⁰ , Mn ⁺ , Mn²⁺, Mn³⁺ , Mn ⁴⁺ , Mn ⁵⁺ , Mn ⁶⁺ , Mn ⁷⁺
Molybdenum	Mo ⁴⁻ , Mo ²⁻ , Mo ⁻ , Mo ⁰ , Mo ⁺ , Mo ²⁺ , Mo ³⁺ , Mo⁴⁺, Mo⁵⁺, Mo⁶⁺
Nickel	Ni ²⁻ , Ni ⁻ , Ni ⁰ , Ni ⁺ , Ni²⁺ , Ni ⁴⁺
Vanadium	V ⁻ , V ⁰ , V ⁺ , V ²⁺ , V³⁺, V⁴⁺, V⁵⁺
Zinc	Zn ²⁻ , Zn ⁰ , Zn ⁺ , Zn²⁺

Shown are the possible valence states for each of the nutritionally essential transition states. Biochemically and physiologically relevant valence states are highlighted in red.

Transition Metal Ions Are Potent Lewis Acids

In addition to serving as electron carriers, the functional capabilities of the nutritionally essential transition metals are enhanced by their ability to act as Lewis acids. Protic (Bronsted-Lowry) acids can donate a proton (H⁺) to an acceptor with a lone pair of electrons, for example, a primary amine or a molecule of water. **Lewis acids**, by contrast, are *aprotic*. Like H⁺ ions, Lewis acids possess empty valence orbitals capable of noncovalently associating with or “accepting” a lone pair of electrons from a second, “donor” molecule. The ferrous (Fe²⁺) iron of myoglobin and hemoglobin act as Lewis bases when they bind oxygen or other diatomic gases such as carbon monoxide (see [Chapter 8](#)). Divalent Zn²⁺ or Mn²⁺ can serve as Lewis acids during catalysis by hydrolytic enzymes, specifically by enhancing the nucleophilicity of active-site water molecules.

TOXICITY OF HEAVY METALS

Most heavy metals, a loosely defined term for metallic elements with

densities greater than 5 g/cm^3 or atomic numbers > 20 , are toxic. Some well-known examples include arsenic, antimony, lead, mercury, and cadmium, whose toxicity can arise via a number of mechanisms.

Displacement of an Essential Cation

The ability of a heavy metal to displace a functionally essential metal can readily lead to loss or impairment of function. Classic examples include the displacement of iron by **gallium** in the enzymes ribonucleotide reductase and Fe, Cu superoxide dismutase. Ga^{3+} , while of similar size and identical charge to Fe^{3+} , lacks the multivalence capability of iron. Replacement of Fe^{3+} by Ga^{3+} therefore renders affected enzymes catalytically inert.

Enzyme Inactivation

Heavy metals readily form adducts with free sulfhydryl groups. If present in proteins, formation of these adducts undermines a protein's structural integrity, with concomitant impairment of function. Examples include the inhibition of δ -aminolevulinate synthase by Pb (see [Chapter 31](#)) and the inactivation of the pyruvate dehydrogenase complex by arsenic or mercury. In pyruvate dehydrogenase, the heavy metals react with the sulfhydryl on the essential prosthetic group, lipoic acid (see [Chapter 18](#)), rather than with a peptidyl cysteine.

Formation of Reactive Oxygen Species

Heavy metals can induce the formation of reactive oxygen species (ROS), which can then damage DNA, membrane lipids, and other biomolecules (see [Chapter 58](#)). Oxidative damage to DNA can cause genetic mutations that may lead to cancer or other pathophysiologic conditions. ROS-mediated peroxidation of lipid molecules (see [Figure 21–23](#)) can lead to the loss of membrane integrity. The resulting dissipation of action potentials and disruption of various cross-membrane transport processes can be particularly deleterious to neurologic and neuromuscular functions. It has also been reported that rats fed with excessive levels of heavy metals are prone to develop cancerous tumors.

TOXICITY OF TRANSITION METALS

While nutritionally essential, several transition metals are nonetheless harmful if present in the body in excess (**Table 10–3**). Consequently, higher organisms exert strict control over both the uptake and excretion of transition metal ions. Examples include the **hepcidin** system for regulation of iron (see **Figure 52–8**) to avoid its accumulation to damaging levels. These mechanisms can be circumvented to some degree when transition metals enter via inhalation or absorption through the skin or mucous membranes, and can be overwhelmed by ingestion of massive, supraphysiologic levels. Typical symptoms of acute metal poisoning by heavy metals or by transitional metals include abdominal pain, vomiting, muscle cramps, confusion, and numbness. Treatments include administration of metal chelating agents, diuretics, or—should kidney function be compromised—hemodialysis.

TABLE 10–3 Relative Toxicity of Metals

Toxicity		
Nontoxic	Low	Medium to High
Aluminum Manganese	Barium Tin	Antimony Niobium
Bismuth Molybdenum	Cerium Ytterbium	Beryllium Palladium
Calcium Potassium	Germanium Yttrium	Cadmium Platinum
Cesium Rubidium	Gold	Chromium Selenium
Iron Sodium	Rhodium	Cobalt Thorium
Lithium Strontium	Scandium	Copper Titanium
Magnesium	Terbium	Indium Tungsten
		Lead Uranium
		Mercury Vanadium
		Polonium Zirconium
		Nickel Zinc

Nutritionally essential transition metals are in red type. US Geological Circular 1133 (1995).

LIVING ORGANISMS PACKAGE TRANSITION METALS WITHIN ORGANOMETALLIC COMPLEXES

Complexation Enhances Solubility and Controls

Reactivity of Transition Metal Ions

The levels of free transition metals in the body are, under normal circumstances, extremely low. The vast majority are found either associated directly with proteins via the oxygen, nitrogen, and sulfur atoms found on the side chains of amino acids such as aspartate, glutamate, histidine, or cysteine (**Figure 10–2**); or with other organic moieties such as porphyrin (see **Figure 6–1**), corrin (see **Figure 44–10**), or pterins (**Figure 10–3**). The sequestration of transition metals into organometallic complexes confers multiple advantages that include protection against oxidation, suppression of ROS production, enhancement of solubility, control of reactivity, and assembly of multimetal units (**Figure 10–4**).

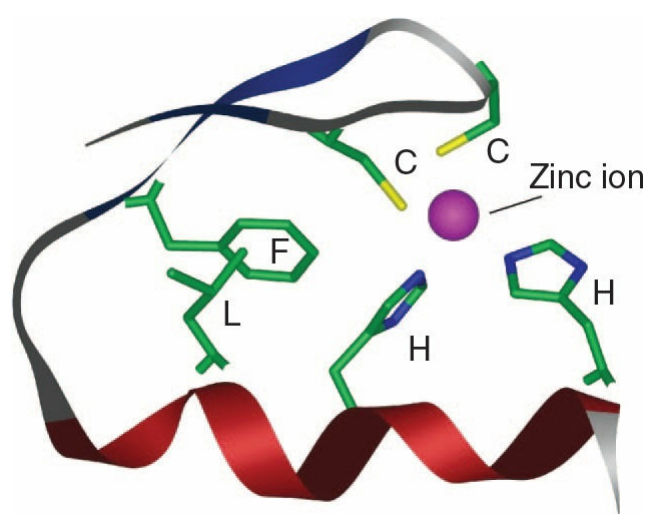

FIGURE 10–2 Ribbon diagram of a consensus C2H2 zinc finger domain. Shown are the bound Zn^{2+} (purple) and the R groups of the conserved phenylalanyl (F), leucyl (L) cysteinyl (C), and histidinyl (H) residues with their carbon atoms in green. The polypeptide backbone is shown as a ribbon, with alpha helical portions highlighted in red. The sulfur and nitrogen atoms of the R groups of the cysteinyl and histidyl residues are shown in yellow and blue, respectively.

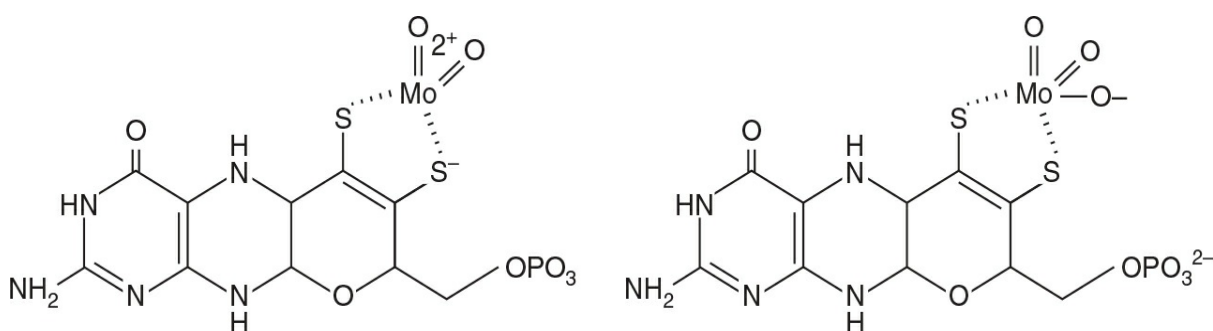

FIGURE 10–3 Molybdopterin. Shown are the oxidized (**left**) and reduced (**right**) forms of molybdopterin.

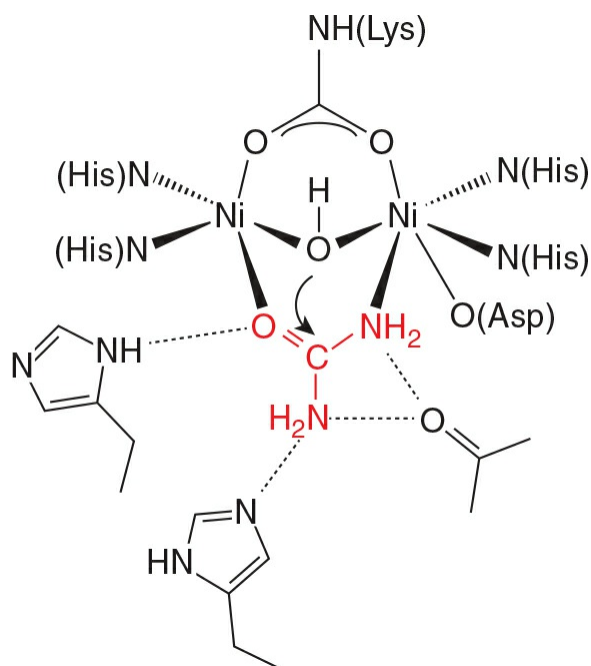

FIGURE 10–4 Hydrolysis of urea requires the cooperative influence of two active site Ni atoms. The figure depicts the formation of the transition state intermediate for the hydrolysis of the first C-N bond in urea (red) by the enzyme urease. Note how the Ni atoms chelate a water molecule to form a nucleophilic hydroxide and weaken the C-N bond through Lewis acid interactions with lone pairs of electrons on the O and one of the N atoms of urea.

Significance of Multivalent Capability

Physiologic function of transition metal–containing cofactors and prosthetic groups is dependent on maintaining a multivalent ion’s appropriate oxidation state. For example, the porphyrin ring and proximal and distal histidyl residues of the globin polypeptide chain that complex the Fe^{2+} atoms in hemoglobin protects them from oxidation to Fe^{3+} -containing methemoglobin, which is incapable of binding to and transporting oxygen (see [Chapter 6](#)). Free transition metal ions are vulnerable to oxidation by O_2 and agents inside the cell. Not only are free transition metal ions vulnerable to nonspecific oxidation, their interaction with oxidizing agents such as O_2 , NO , and H_2O_2 generally results in the generation of even more reactive ROS (see [Figure 58–2](#)). Incorporation into organometallic complexes thus protects both the functionally relevant

oxidation state of the transition metal and the potential for generating harmful ROS.

Adjacent Ligands Can Modify Redox Potential

In organometallic complexes, the position and identity of the surrounding ligands can modify or tune the redox potential and Lewis acid potency of transition metal ions, thereby optimizing them for specific tasks (**Table 10–4**). For example, both cytochrome c and myoglobin are small, 12 to 17 kDa, monomeric proteins that contain a single heme iron. While the iron in myoglobin is optimized by its surroundings, both to bind oxygen and to maintain a constant, Fe^{2+} , valence state, the iron atom in cytochrome c is optimized to cycle between the +2 and +3 valence states so the protein can carry electrons between complexes III and IV of the electron transport chain. The superoxide dismutases (SODs) illustrate how complexation can adapt different transition metals as catalysts for a common chemical reaction, the disproportionation of H_2O_2 into H_2O and O_2 . Each of the four distinct, nonhomologous SODs contain different transition metals whose atomic symbols are used to designate each family: Fe-SODs, Mn-SODs, Ni-SODs, and Cu, Zn-SODs.

TABLE 10–4 Some Biologically Important Metalloproteins

Protein	Function or Reaction Catalyzed	Metal(s)
Aconitase	Isomerization	Fe-S center
Alcohol dehydrogenase	Oxidation	Zn
Alkaline phosphatase	Hydrolysis	Zn
Arginase	Hydrolysis	Mn
Aromatase	Hydroxylation	Heme Fe
Azurin (bacteria)	e ⁻ transport	Cu
Carbonic anhydrase	Hydration	Zn
Carboxypeptidase A	Hydrolysis	Zn
Cytochrome c	e ⁻ transport	Heme Fe
Cytochrome oxidase	Reduction of O ₂ to H ₂ O	Heme Fe
Cytochrome P450	Oxidation & hydroxylation	Heme Fe (2) & Cu (2)
Dopamine β-hydroxylase	Hydroxylation	Cu
Ferredoxin	e ⁻ transport	Fe-S center
Galactosyl transferase	Glycoprotein synthesis	Mn
Hemoglobin	O ₂ transport	Heme Fe (4)
Isocitrate dehydrogenase	Oxidation	Mn
β-Lactamase II (bacteria)	Hydrolysis	Zn
Lysyl oxidase	Oxidation	Cu
Matrix metalloprotease	Hydrolysis	Zn
Myoglobin	O ₂ storage	Heme Fe
Nitric oxide synthase	Reduction	Heme Fe
Nitrogenase (bacteria)	Reduction	Fe, Mo cofactor, P-cluster (Fe), Fe-S center
Phospholipase C	Hydrolysis	Zn
Ribonucleotide reductase	Reduction	Fe (2)
Sulfite oxidase	Oxidation	Molybdopterin & Fe-S center
Superoxide dismutase (cytoplasmic)	Disproportionation	Cu, Zn
Urease (plant)	Hydrolysis	Ni
Xanthine oxidase	Oxidation	Molybdopterin & Fe-S center

Complexation Can Organize Multiple Metal Ions in a Single Functional Unit

The formation of organometallic complexes also allows multiple metal ions to be assembled together in a single functional unit with capabilities that lie beyond those obtainable with a single transition metal ion. In the plant enzyme urease, which catalyzes the hydrolysis of urea in plants, the presence of two Ni atoms within the active site enables the enzyme to simultaneously polarize electrons in the C-N bond targeted for hydrolysis and to activate the attacking water molecule (Figure 10–4). The presence of two Fe and two Cu atoms in cytochrome oxidase enables the complex IV of the electron transport chain to accumulate the four electrons needed to carry out the reduction of oxygen to water. Similarly, the bacterial enzyme nitrogenase employs an 8Fe-7S prosthetic group called the P-cluster and a unique Fe, Mo-cofactor to carry out the eight-electron reduction of atmospheric nitrogen to ammonia.

PHYSIOLOGIC ROLES OF THE ESSENTIAL TRANSITION METALS

Iron

Iron is one of the most functionally versatile of the physiologically essential transition metals. Both in hemoglobin and myoglobin the heme-bound Fe^{2+} iron is used to bind a diatomic gas, O_2 , for transport and storage, respectively (see Chapter 6). Similarly, in marine invertebrates, the iron present in the **diiron center** of hemerythrin (Figure 10–5) can bind and transport oxygen. By contrast, the iron atoms contained in the heme groups of the b- and c-type cytochromes and the Fe-S clusters (see Figure 13–4) and Rieske iron centers (Figure 10–6) of other electron transport chain components transport electrons by cycling between their ferrous (+2) and ferric state (+3).

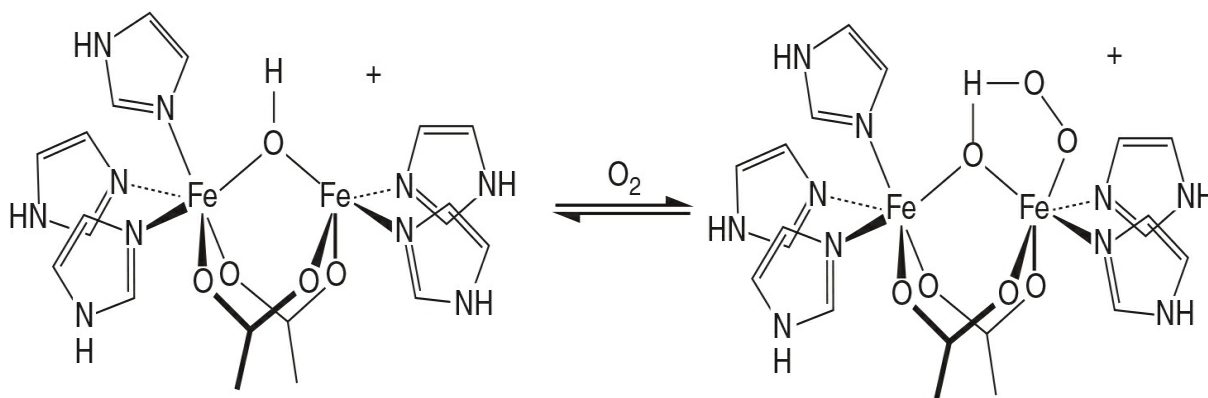

FIGURE 10–5 Diiron center of the deoxy (left) and oxy (right) forms of hemerythrin. Shown are the side chains of the histidine, glutamate, and aspartate residues responsible for binding the metal ions to the polypeptide.

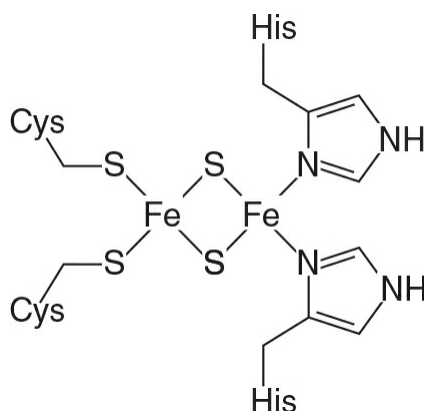

FIGURE 10–6 Structure of a Rieske iron center. Rieske iron centers are a type of 2Fe-2S cluster in which histidine residues replace two of the cysteine residues that normally bind the prosthetic group to the polypeptide chain.

Roles of Iron in Redox Reactions

The iron atoms of metalloproteins participate in catalysis of oxidation–reduction, or redox, reactions. Stearoyl-acyl carrier protein Δ^9 -desaturase and type 1 ribonucleotide reductase employ hemerythrin-like diiron centers to catalyze the reduction of carbon–carbon double bonds and an alcohol, respectively, to methylene groups. Methane monooxygenase uses a similar diiron center for the oxidation of methane to methanol. The members of the cytochrome P450 family generate $\text{Fe} = \text{O}^{3+}$. This is a powerful oxidant that participates in the reduction and neutralization of a broad range of xenobiotics via the two-electron reduction of O_2 , a complex

process during which the heme iron cycles between +2, +3, +4, and +5 oxidation states.

Participation of Iron in Non-Redox Reactions

Purple acid phosphatases, bimetallic enzymes containing one atom of iron matched with a second metal, such as Zn, Mn, Mg, or a second Fe, catalyze the hydrolysis of phosphomonoesters. Myeloperoxidase employs heme iron to catalyze the condensation of H_2O_2 with Cl^- ions to generate hypochlorous acid, HOCl, a potent bactericide used by macrophages to kill entrapped microorganisms. It recently has been shown that many enzymes involved in DNA replication and repair, including DNA helicase, DNA primase, several DNA polymerases, some glycosylases and endonucleases, and several transcription factors contain Fe-S clusters. While their elimination generally results in a loss of protein function, the role(s) performed by these Fe-S centers remains cryptic. However, since most are located in the DNA binding, rather than the catalytic domains of these proteins, it has been proposed that these Fe-S centers may function as electrochemical detectors for the identification of damaged DNA. Others speculate that these clusters serve as redox-sensitive modulators of catalytic activity or DNA binding, or simply as stabilizers of the three-dimensional structure of these proteins.

Manganese

Humans contain a handful of Mn-containing enzymes, the majority of which are located within the mitochondria. These include isocitrate dehydrogenase from the tricarboxylic acid (TCA) cycle, two key players in nitrogen metabolism: glutamate synthetase and arginase, and the gluconeogenic enzymes pyruvate carboxylase and phosphoenolpyruvate carboxykinase, isopropyl malate synthase, and the mitochondrial isozyme of superoxide dismutase. In most of these enzymes, Mn is present in the +2 oxidation state and is presumed to act as a Lewis acid. By contrast, some bacterial organisms employ Mn in several enzymes responsible for catalyzing redox reactions, where it cycles between the +2 and +3 oxidation states in, for example, Mn-superoxide dismutase (Mn-SOD), Mn-ribonucleotide reductase, and Mn-catalase.

Zinc

Unlike the divalent (+2) ions of other first-row transition metals ([Figure](#)

10–1), the valence shell of Zn^{2+} possesses a full set of electrons. As a consequence, Zn^{2+} ions do not adopt alternate oxidation states under physiologic conditions, rendering it unsuitable to participate in electron transport processes or as a catalyst for redox reactions. On the other hand, redox inert Zn^{2+} ions also pose a minimal risk of generating harmful ROS species. Its unique status among the physiologically essential transition metals renders Zn^{2+} an ideal candidate as a ligand for stabilizing the protein conformation.

It has been estimated that the human body contains 3000 zinc-containing metalloproteins. The vast majority of these are transcription factors and other DNA- and RNA-binding proteins that contain anywhere from one to thirty copies of a Zn^{2+} -containing polynucleotide-binding domain known as a zinc finger. Zinc fingers consist of a polypeptide loop whose conformation is stabilized by the interactions between Zn^{2+} and lone pairs of electrons donated by the sulfur and nitrogen atoms contained in two conserved cysteine and two conserved histidine residues (see [Figure 38–16](#)). Zinc fingers bind polynucleotides with a high degree of site specificity that is conferred, at least in part, by variations in the sequence of amino acids that make up the remainder of the loop. Scientists are working to exploit this combination of small size and binding specificity to construct sequence-specific nucleases for use in genetic engineering and, eventually, gene therapy.

Zn^{2+} is also an essential component of several metalloenzymes, including carboxypeptidase A, carbonic anhydrase II, adenosine deaminase, alkaline phosphatase, phospholipase C, leucine aminopeptidase, the cytosolic form of superoxide dismutase, and alcohol dehydrogenase. Zn^{2+} is also a component of the type II β -lactamases used by bacteria to neutralize penicillin and other lactam antibiotics. These metalloenzymes exploit the Lewis acid properties of Zn^{2+} to stabilize the development of negatively charged intermediates, polarize the distribution of electrons in carbonyl groups, and enhance the nucleophilicity of water ([Figure 10–7](#)).

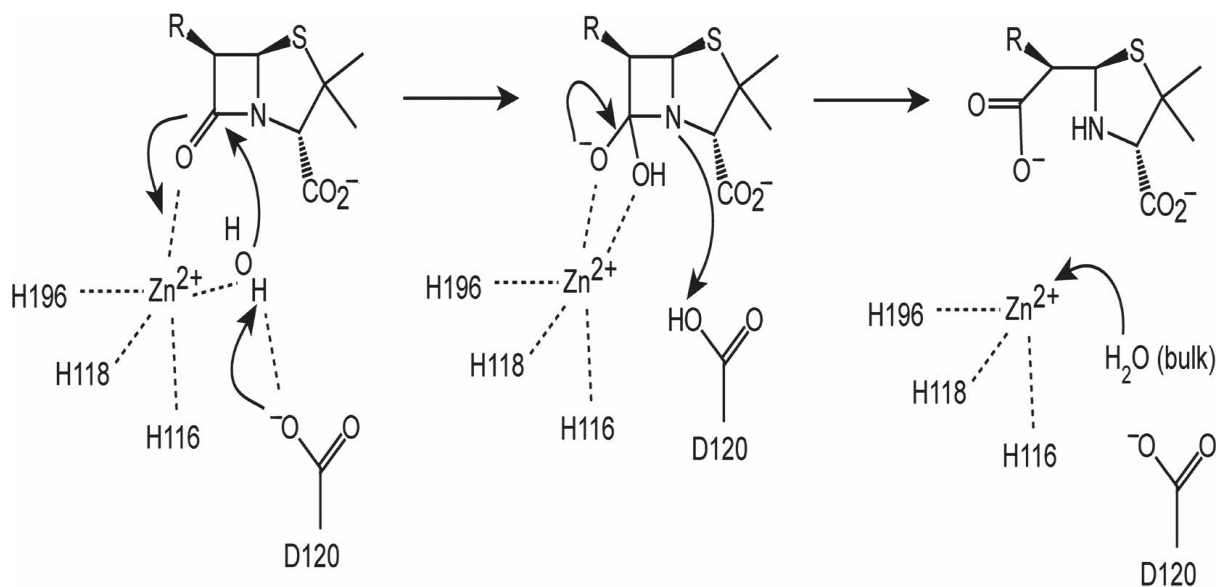

FIGURE 10–7 Role of Zn^{2+} in catalytic mechanisms of β -lactamase
II. Zn^{2+} is bound to the enzyme via the nitrogen atoms present in the side chains of multiple histidine (H) residues. **Left:** Zn^{2+} activates a water molecule, one of whose protons is accommodated by aspartic acid (D) residue 120, which (**middle**) executes a nucleophilic attack on carbonyl C of the lactam ring of the antibiotic. **Right:** D120 then donates the bound proton to the lactam nitrogen, facilitating the cleavage of the C-N bond in the tetrahedral intermediate.

Cobalt

The predominant and, thus far, only known biochemical function of dietary cobalt is as the core component of 5'-deoxyadenosylcobalamin, otherwise known as vitamin B_{12} (see [Figure 44–10](#)). The Co^{3+} in this cofactor resides at the center of a tetrapyrrole corrin ring where it acts as a Lewis base that binds to and facilitates the transfer of one-carbon, methyl or methylene groups. In humans, this includes the enzyme catalyzed transfer of a $-\text{CH}_3$ group from tetrahydrofolate to homocysteine, the final step in the synthesis of the amino acid methionine (see [Figure 44–13](#)), and the rearrangement of methylmalonyl-CoA to form succinyl-CoA during the catabolism of the propionate generated from the metabolism of isoleucine and lipids containing odd numbers of amino acids (see [Figure 19–2](#)). During the latter reaction, the Co^{3+} is transiently reduced to the 2+ oxidation state by abstracting an electron to generate a reactive methylene radical, $\text{R}-\text{CH}_2$. More information of Co and vitamin B_{12} can be found in

Copper

Copper is a functionally essential component of approximately 30 different metalloenzymes in humans, including cytochrome oxidase, dopamine β -hydroxylase, tyrosinase, the cytosolic form of superoxide dismutase (Cu, Zn-SOD), and lysyl oxidase. Dopamine β -hydroxylase and tyrosinase are both catecholamine oxidases, enzymes that oxidize the ortho-position in the phenol rings of L-dopamine (see [Figure 41–10](#)) and tyrosine, respectively. The former is the final step in the pathway by which epinephrine is synthesized in the adrenal gland, while the latter is the first and rate-limiting step in the synthesis of melanin. Both dopamine β -hydroxylase and tyrosinase are members of the type-3 family of copper proteins, which share a common **dicopper** center. As shown in [Figure 10–8](#), the copper atoms in catecholamine oxidases chelate a molecule of molecular oxygen, activating it for attack on a phenol ring. During this process the copper atoms cycle between the +2 and +1 oxidation states. Another type-3 copper protein is hemocyanin. Unlike the catecholamine oxidases, the dicopper center of hemocyanin serves to transport oxygen in invertebrate animals such as mollusks that lack hemoglobin.

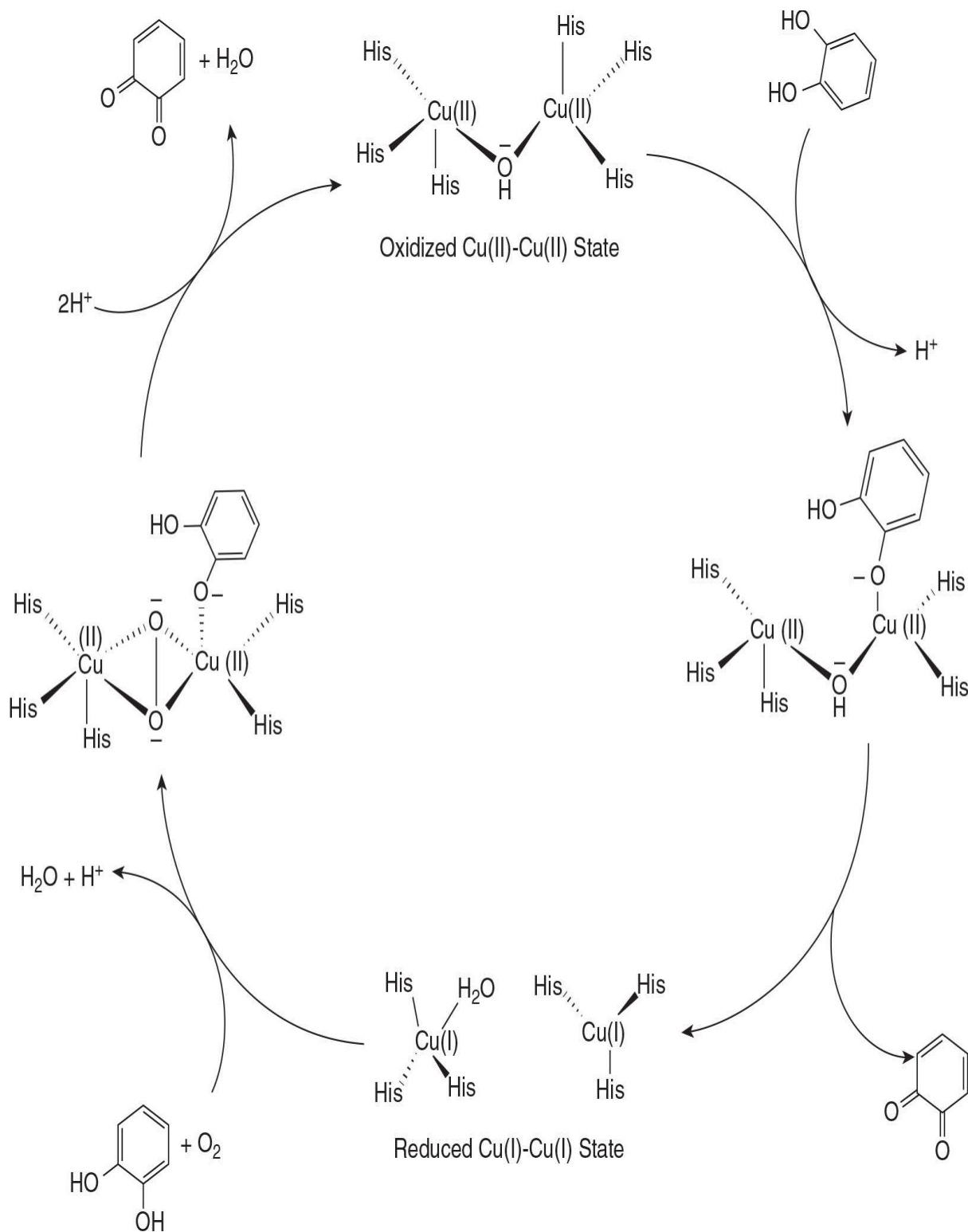

FIGURE 10–8 Reaction mechanism of the catecholamine oxidases.

In Cu, Zn-SOD, the Cu²⁺ atom in the bimetallic center abstracts an electron from superoxide, O₂⁻, an extremely reactive and cytotoxic reactive oxygen species, forming O₂ and Cu¹⁺. The Cu atom in the

enzyme is then restored to its original, +2, valence state by donating an electron to a second molecule of superoxide, generating H_2O_2 . While hydrogen peroxide also is a ROS, it is considerably less reactive than O_2^- , a radical anion. Moreover, it can be subsequently converted to water and O_2 through the action of a second detoxifying enzyme, catalase (see [Chapter 12](#)).

Lysyl oxidase employs a single atom of Cu^2 to convert the epsilon amino groups on lysine side chains in collagen or elastin to aldehydes using molecular oxygen. The aldehyde groups on the side chain of the resulting amino acid, allysine (2-amino-6-oxo-hexanoic acid), then chemically react with the side chains of other allysine or lysine residues on adjacent polypeptides to generate the chemical crosslinks essential to the exceptional tensile strength of mature collagen and elastin fibers. Another essential feature of the enzyme is the presence of a modified amino acid, 2,4,5-trihydroxyphenylalanine quinone, in the active site. This modification is generated by the autocatalytic oxidation of the side chain of conserved tyrosine residue by lysyl oxidase itself.

Nickel

Several nickel-containing enzymes are present in bacterial organisms, where they catalyze redox reactions, for example, Ni, Fe hydrogenase and methyl-coenzyme M reductase, transferase reactions, for example, acetyl-CoA synthase, and disproportionation reactions, for example, superoxide dismutase. Ni is a key component of urease, an enzyme found in bacteria, fungi, and plants ([Figure 10–4](#)). However, the molecular basis of the dietary requirement for nickel in humans and other mammals has yet to be discovered.

Molybdenum

Catalytic Roles of Molybdopterin

Molybdenum is a key component of the phylogenetically universal cofactor molybdopterin ([Figure 10–3](#)). In animals, molybdopterin serves as a catalytically essential prosthetic group for many enzymes, including xanthine oxidase, aldehyde oxidase, and sulfite oxidase. Xanthine oxidase, which also contains flavin, catalyzes the final two oxidative steps in the pathway by which uric acid is synthesized from purine nucleotides: the oxidation of hypoxanthine to xanthine and the oxidation of xanthine to uric

acid (see [Chapter 33](#)). Catalysis of this two-stage process is facilitated by the ability of the bound Mo atom to cycle among the +4, +5, and +6 valence states. In addition to molybdopterin and flavin, aldehyde oxidase also contains an Fe-S cluster. Its complex suite of prosthetic groups enables the enzyme to oxidize a broad range of substrates, including many heterocyclic organic compounds. It has therefore been suggested that aldehyde oxidase participates, like the cytochrome P450 system, in the detoxification of xenobiotics (see [Chapter 47](#)).

Iron & Molybdenum Metalloenzymes

The Fe- and Mo-containing metalloenzyme sulfite oxidase is located in the mitochondria, where it catalyzes the oxidation of the sulfite (SO_3^{2-}) generated by the catabolism of sulfur-containing biomolecules to sulfate, SO_4^{2-} . As for xanthine oxidase, the ability of the molybdenum ion to transition between the +6, +5, and +4 oxidation states is critical to providing a catalytic route by which the two electrons removed from the sulfite molecule can be sequentially transferred to two molecules of cytochrome c, each of which can carry only a single electron ([Figure 10–9](#)). Mutations in any one of three genes—*MOCS1*, *MOCS2*, or *GPNH*—whose protein products catalyze key steps in the synthesis of molybdopterin can lead to **sulfite oxidase deficiency**. Individuals who suffer from this autosomal inherited inborn error of metabolism are incapable of breaking down the sulfur-containing amino acids cysteine and methionine. The resulting accumulation of these amino acids and their derivatives in neonatal blood and tissues produce severe physical deformities and brain damage that leads to intractable seizures, severe mental retardation, and—in most cases—death during early childhood.

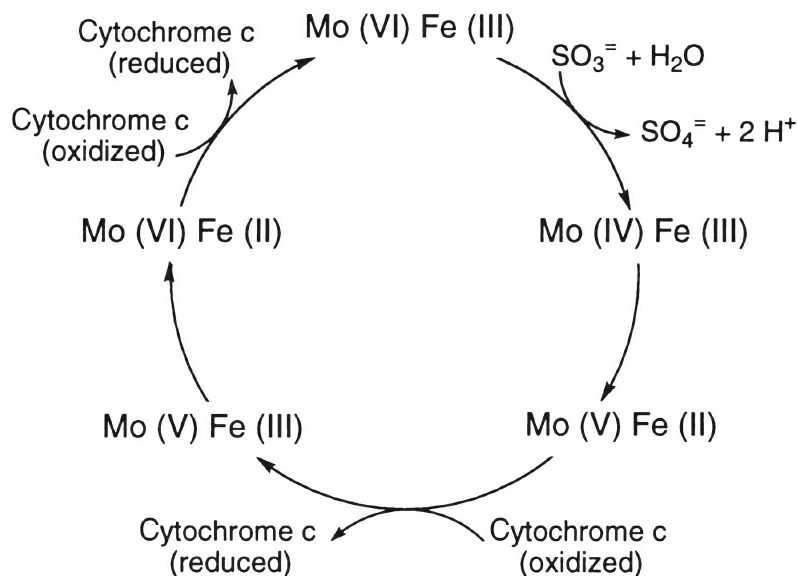

FIGURE 10–9 Reaction mechanism of sulfite oxidase showing oxidation states of enzyme-bound iron and molybdenum atoms.

Vanadium

Although nutritionally essential, the role of vanadium in living organisms remains cryptic. No vanadium-containing cofactor has been identified to date. Vanadium is found throughout the body in both its +4, for example, HVO_4^{2-} , H_2VO_4^- , etc, and +5 oxidation states, for example, VO^{2+} , HVO^{3+} , etc. Various plasma proteins are known to bind oxides of vanadium, including albumin, immunoglobulin G, and transferrin. Although vanadate, a phosphate analog, is known to inhibit protein-tyrosine phosphatases and alkaline phosphatase *in vitro*, it is unclear whether these interactions are of physiologic significance.

Chromium

The role of Cr in humans remains unknown. In the 1950s, a Cr^{3+} -containing “glucose tolerance factor” was isolated from brewer’s yeast whose laboratory effects implicated this transition metal as a cofactor in the regulation of glucose metabolism. However, decades of research have failed to uncover either a Cr-containing biomolecule or a Cr-related genetic disease in animals. Nevertheless, many persons continue to ingest Cr-containing dietary supplements, such as Cr^{3+} -picolinate, for its alleged weight-loss properties.

ABSORPTION & TRANSPORT OF TRANSITION METALS

Transition Metals Are Absorbed by Diverse Mechanisms

In general, intestinal uptake of most transition metals is relatively inefficient. Only a small portion of the transition metals ingested each day is absorbed into our bodies. In addition, some transition metals, such as Ni, can be readily absorbed through the lungs when present in contaminated air or as a component of cigarette smoke. The perceived “inefficiency” of intestinal absorption may reflect the combination of the human body’s modest requirements for these elements and the need to buffer against the accumulation of excessive amounts of these potentially toxic heavy metals. While we understand the pathways by which some transition metals, such as Fe (see [Chapter 52](#)), are taken up in great detail, in other instances, little hard evidence has been uncovered.

Fe^{2+} is absorbed directly via a transmembrane protein, the divalent metal ion transport protein (DMT-1), in the proximal duodenum. DMT-1 is also postulated to constitute the primary vehicle for the uptake of Mn^{2+} , Ni^{2+} , and—to a lesser extent— Cu^{2+} . As most of the iron in the stomach is in the ferric state, Fe^{3+} , it must be reduced to the ferrous, Fe^{2+} , state in order to be absorbed. This reaction is catalyzed by a ferric reductase also present on the cell surface, **duodenal cytochrome b (Dcytb)**. Dcytb also is responsible for reducing Cu^{2+} to Cu^{1+} prior to transport by the high affinity Cu transport protein Ctr1. Molybdenum and vanadium are absorbed in the gut as the oxyanions vanadate, HVO_4^{2-} , and molybdate, HMoO_4^{2-} , by the same nonspecific anion transporter responsible for the absorption of their structural analogs phosphate, HPO_4^{2-} , and sulfate, SO_4^{2-} . Similarly, excess levels of Zn can trigger potentially lethal anemia by inhibiting absorption of a second essential nutrient transition metal, Cu.

Cobalt is absorbed as the organometallic complex cobalamin, that is, vitamin B₁₂, via a dedicated pathway involving two secreted cobalamin-binding proteins, haptocorrin and intrinsic factor, and a cell surface receptor, cubilin. In the stomach, cobalamin released from ingested foods binds to haptocorrin, which protects the coenzyme from the extreme pH of its surroundings. As the cobalamin-haptocorrin complex moves into the

duodenum, the pH increases, inducing dissociation of the complex. The released cobalamin is then bound by a haptocorrin homolog known as intrinsic factor. The resulting cobalamin-intrinsic factor complex is then recognized and internalized by cubilin receptors present on the surface of intestinal epithelial cells.

SUMMARY

- Maintenance of human health and vitality requires the dietary uptake of trace quantities of several inorganic elements, including several transition metals.
- Many heavy metals, including excess levels of some of the nutritionally essential transition metals, are toxic and potentially carcinogenic.
- Most heavy metals, including essential transition metals, can generate reactive oxygen species in the presence of water and oxygen.
- Acute heavy metal poisoning is treated by ingestion of chelating agents, the administration of diuretics along with the ingestion of water, or hemodialysis.
- The capacity of transition metals to serve as carriers for electrons and diatomic gases, as well as to facilitate catalysis of a wide range of enzymatic reactions, derives from two factors: their ability to transition between multiple valence states and their Lewis acid properties.
- In the body, transition metal ions are rarely encountered in free form. In most instances, they exist in organometallic complexes bound to proteins either directly by amino acid side chains or as part of organometallic prosthetic groups such as hemes, Fe-S clusters, or molybdopterin.
- Incorporation into organometallic complexes serves as a means of optimizing the properties of associated transition metals, prevents the collateral generation of reactive oxygen species, and assembles multiple transition metals into a single functional unit.
- In the electron transport chain, many key electron transfer events rely on the ability of Fe atoms present in hemes, Fe-S clusters, and Rieske iron centers to transition between their +2 and +3 oxidation states.
- The presence of two Fe and two Cu atoms enables cytochrome oxidase to accumulate the four electrons needed to reduce molecular oxygen to water in the last step of the electron transport chain.

- Fe is commonly employed as a prosthetic group in many of the metalloenzymes that catalyze oxidation–reduction reactions.
- The majority of the nearly 3000 predicted zinc-metalloproteins encoded by the human genome contains a conserved polynucleotide-binding motif, the zinc finger.
- Fe-S clusters are present in many of the proteins involved in DNA replication and repair. It has been postulated that these prosthetic groups serve as electrochemical sensors for DNA damage.
- The Lewis acid capacity of Zn^{2+} is commonly utilized to increase the nucleophilicity of water by enzymes that catalyze hydrolytic reactions.
- The Mo atoms in xanthine oxidase and sulfite oxidase cycle between three different valence states during catalysis.
- The buildup of the S-containing amino acids methionine and cysteine in persons suffering from a deficiency in the Fe, Mo-metalloenzyme sulfite oxidase causes serious developmental defects and death in infancy.
- In humans, the only known function of Co is as a component of 5'-deoxyadenosylcobalamin, vitamin B₁₂, a cofactor involved in the transfer of one-carbon groups. Co is absorbed into the body as its vitamin B₁₂ complex.

REFERENCES

- Ba LA, Doering M, Burkholz T, Jacob C: Metal trafficking: from maintaining the metal homeostasis to future drug design. *Metallomics* 2009;1:292.
- Fuss JO, Tsai CL, Ishida JP, Tainer JA: Emerging critical roles of Fe-S clusters in DNA replication and repair. *Biochim Biophys Acta* 2015;1853:1253.
- Liu J, Chakraborty S, Hosseinzadeh P, et al: Metalloproteins containing cytochrome, iron-sulfur, or copper redox centers. *Chem Revf* 2014;114:4366.
- Lyons TJ, Elde DJ: Transport and storage of metal ions in biology. In *Biological Inorganic Chemistry*. Bertini I, Gray HB, Stiefel EI, Valentine JS (editors). University Science Books, 2007:57-77.
- Maret M: Zinc biochemistry: from a single zinc enzyme to a key element of life. *Adv Nutr* 2013;4:82.
- Maret M, Wedd A (editors): *Binding, Transport and Storage of Metal Ions in Biological Cells*. Royal Society of Chemistry, 2014:(Entire volume).

Zhang C: Essential functions of iron-requiring proteins in DNA replication, repair and cell cycle control. *Protein Cell* 2014;5:750.

Exam Questions

Section II – Enzymes: Kinetics, Mechanism, Regulation, & Role of Transition Metals

1. Rapid shallow breathing can lead to hyperventilation, a condition wherein carbon dioxide is exhaled from the lungs more rapidly than it is produced by the tissues. Explain how hyperventilation can lead to an increase in the pH of the blood.
2. A protein engineer desires to alter the active site of chymotrypsin so that it will cleave peptide bonds to the C-terminal side of aspartyl and glutamyl residues. The protein engineer will be most likely to succeed if he replaces the hydrophobic amino acid at the bottom of the active site pocket with:
 - A. Phenylalanine
 - B. Threonine
 - C. Glutamine
 - D. Lysine
 - E. Proline
3. Select the one of the following statements that is NOT CORRECT.
 - A. Many mitochondrial proteins are covalently modified by the acetylation of the epsilon amino groups of lysine residues.
 - B. Protein acetylation is an example of a covalent modification that can be “reversed” under physiologic conditions.
 - C. Increased levels of acetyl-CoA tend to favor protein acetylation.
 - D. Acetylation increases the steric bulk of the amino acid side chains that are subject to this modification.
 - E. The side chain of an acetylated lysyl residue is a stronger base than

that of an unmodified lysyl residue.

4. Select the one of the following statements that is NOT CORRECT.
 - A. Acid–base catalysis is a prominent feature of the catalytic mechanism of the HIV protease.
 - B. Fischer’s lock-and-key model explains the role of transition state stabilization in enzymic catalysis.
 - C. Hydrolysis of peptide bonds by serine proteases involves the transient formation of a modified enzyme.
 - D. Many enzymes employ metal ions as prosthetic groups or cofactors.
 - E. In general, enzymes bind transition state analogs more tightly than substrate analogs.

5. Select the one of the following statements that is NOT CORRECT.
 - A. To calculate K_{eq} , the equilibrium constant for a reaction, divide the initial rate of the forward reaction (rate 1) by the initial velocity of the reverse reaction (rate 1).
 - B. The presence of an enzyme has no effect on K_{eq} .
 - C. For a reaction conducted at constant temperature, the fraction of the potential reactant molecules possessing sufficient kinetic energy to exceed the activation energy of the reaction is a constant.
 - D. Enzymes and other catalysts lower the activation energy of reactions.
 - E. The algebraic sign of ΔG , the Gibbs free energy change for a reaction, indicates the direction in which a reaction will proceed.

6. Select the one of the following statements that is NOT CORRECT.
 - A. As used in biochemistry, the standard state concentration for products and reactants other than protons is 1 molar.
 - B. ΔG is a function of the logarithm of K_{eq} .
 - C. As used in reaction kinetics, the term “spontaneity” refers to whether the reaction as written is favored to proceed from left to right.
 - D. ΔG° denotes the change in free energy that accompanies transition from the standard state to equilibrium.

- E. Upon reaching equilibrium, the rates of the forward and reverse reaction both drop to zero.
7. Select the one of the following statements that is NOT CORRECT.
- A. Enzymes lower the activation energy for a reaction.
 - B. Enzymes often lower the activation energy by destabilizing transition state intermediates.
 - C. Active site histidyl residues frequently aid catalysis by acting as proton donors or acceptors.
 - D. Covalent catalysis is employed by some enzymes to provide an alternative reaction pathway.
 - E. The presence of an enzyme has no effect on ΔG° .
8. Select the one of the following statements that is NOT CORRECT.
- A. For most enzymes, the initial reaction velocity, v_i , exhibits a hyperbolic dependence on $[S]$.
 - B. When $[S]$ is much lower than K_m , the term $K_m + [S]$ in the Michaelis-Menten equation closely approaches K_m . Under these conditions, the rate of catalysis is a linear function of $[S]$.
 - C. The molar concentrations of substrates and products are equal when the rate of an enzyme-catalyzed reaction reaches half of its potential maximum value ($V_{max}/2$).
 - D. An enzyme is said to have become saturated with substrate when successively raising $[S]$ fails to produce a significant increase in v_i .
 - E. When making steady-state rate measurements, the concentration of substrates should greatly exceed that of the enzyme catalyst.
9. Select the one of the following statements that is NOT CORRECT.
- A. Certain monomeric enzymes exhibit sigmoidal initial rate kinetics.
 - B. The Hill equation is used to perform quantitative analysis of the cooperative behavior of enzymes or carrier proteins such as hemoglobin or calmodulin.
 - C. For an enzyme that exhibits cooperative binding of substrate, a value of n (the Hill coefficient) greater than unity is said to exhibit positive cooperativity.
 - D. An enzyme that catalyzes a reaction between two or more

- substrates is said to operate by a sequential mechanism if the substrates must bind in a fixed order.
- E. Prosthetic groups enable enzymes to add chemical groups beyond those present on amino acid side chains.
10. Select the one of the following statements that is NOT CORRECT.
- A. IC_{50} is a simple operational term for expressing the potency of an inhibitor.
 - B. Lineweaver-Burk and Dixon plots employ rearranged versions of the Michaelis-Menten equation to generate linear representations of kinetic behavior and inhibition.
 - C. A plot of $1/v_i$ versus $1/[S]$ can be used to evaluate the type and affinity for an inhibitor.
 - D. Simple noncompetitive inhibitors lower the apparent K_m for a substrate.
 - E. Noncompetitive inhibitors typically bear little or no structural resemblance to the substrate(s) of an enzyme-catalyzed reaction.
11. Select the one of the following statements that is NOT CORRECT.
- A. For a given enzyme, the intracellular concentrations of its substrates tend to be close to their K_m values.
 - B. The sequestration of certain pathways within intracellular organelles facilitates the task of metabolic regulation.
 - C. The earliest step in a biochemical pathway where regulatory control can be efficiently exerted is the first committed step.
 - D. Feedback regulation refers to the allosteric control of an early step in a biochemical pathway by the end product(s) of that pathway.
 - E. Metabolic control is most effective when one of the more rapid steps in a pathway is targeted for regulation.
12. Select the one of the following statements that is NOT CORRECT.
- A. The Bohr effect refers to the release of protons that occurs when oxygen binds to deoxyhemoglobin.
 - B. Shortly after birth of a human infant, synthesis of the α -chain undergoes rapid induction until it comprises 50% of the hemoglobin tetramer.
 - C. The β -chain of fetal hemoglobin is present throughout gestation.

- D. The term thalassemia refers to any genetic defect that results in partial or total absence of the α - or β -chains of hemoglobin.
- E. The taut conformation of hemoglobin is stabilized by several salt bridges that form between the subunits.
13. Select the one of the following statements that is NOT CORRECT.
- A. Steric hindrance by histidine E7 plays a critical role in weakening the affinity of hemoglobin for carbon monoxide (CO).
- B. Carbonic anhydrase plays a critical role in respiration by virtue of its capacity to break down 2,3-bisphosphoglycerate in the lungs.
- C. Hemoglobin S is distinguished by a genetic mutation that substitutes Glu6 on the β subunit with Val, creating a sticky patch on its surface.
- D. Oxidation of the heme iron from the +2 to the +3 state abolishes the ability of hemoglobin to bind oxygen.
- E. The functional differences between hemoglobin and myoglobin reflect, to a large degree, differences in their quaternary structure.
14. Select the one of the following statements that is NOT CORRECT.
- A. The charge-relay network of trypsin makes the active site serine a stronger nucleophile.
- B. The Michaelis constant is the substrate concentration at which the rate of the reaction is half-maximal.
- C. During transamination reactions, both substrates are bound to the enzyme before either product is released.
- D. Histidine residues act both as acids and as bases during catalysis by an aspartate protease.
- E. Many coenzymes and cofactors are derived from vitamins.
15. Select the one of the following statements that is NOT CORRECT.
- A. Interconvertible enzymes fulfill key roles in integrated regulatory networks.
- B. Phosphorylation of an enzyme often alters its catalytic efficiency.
- C. "Second messengers" act as intracellular extensions or surrogates for hormones and nerve impulses impinging on cell surface receptors.
- D. The ability of protein kinases to catalyze the reverse reaction that removes the phosphoryl group is key to the versatility of this

- molecular regulatory mechanism.
- E. Zymogen activation by partial proteolysis is irreversible under physiologic conditions.
16. Which of the following is NOT a benefit obtained by incorporating physiologically essential transition metal ions into organometallic complexes?
- A. Optimization of Lewis acid potency of the bound metal.
 - B. Ability to construct complexes containing multiple transition metal ions.
 - C. Attenuation of the production of reactive oxygen species.
 - D. Protection against unwanted oxidation.
 - E. To render the bound transition metal multivalent.
17. Which of the following is NOT a potential function of the physiologically essential transition metals?
- A. Binding diatomic gas molecules
 - B. Proton carrier
 - C. Stabilizing protein conformation
 - D. Enhancing the nucleophilicity of water
 - E. Electron carrier
18. Acute heavy metal poisoning can be treated by:
- A. Administration of diuretics
 - B. Ingestion of chelating agents
 - C. Hemodialysis
 - D. All of the above
 - E. None of the above
19. Which of the following is the name of a common organometallic DNA-binding motif?
- A. Zinc finger
 - B. Molybdopterin
 - C. Fe-S center
 - D. All of the above
 - E. None of the above

SECTION

III

Bioenergetics

CHAPTER

11

Bioenergetics: The Role of ATP

Kathleen M. Botham, PhD, DSc & Peter A. Mayes, PhD, DSc

OBJECTIVES

After studying this chapter, you should be able to:

- State the first and second laws of thermodynamics and understand how they apply to biologic systems.
- Explain what is meant by the terms free energy, entropy, enthalpy, exergonic, and endergonic.
- Appreciate how reactions that are endergonic may be driven by coupling to those that are exergonic in biologic systems.
- Explain the role of group transfer potential, adenosine triphosphate (ATP), and other nucleotide triphosphates in the transfer of free energy from exergonic to endergonic processes, enabling them to

act as the “energy currency” of cells.

BIOMEDICAL IMPORTANCE

Bioenergetics, or biochemical thermodynamics, is the study of the energy changes accompanying biochemical reactions. Biologic systems are essentially **isothermic** and use chemical energy to power living processes. The way in which an animal obtains suitable fuel from its food to provide this energy is basic to the understanding of normal nutrition and metabolism. Death from **starvation** occurs when available energy reserves are depleted, and certain forms of malnutrition are associated with energy imbalance (**marasmus**). Thyroid hormones control the **metabolic rate** (rate of energy release), and disease results if they malfunction. Excess storage of surplus energy causes **obesity**, an increasingly common disease of Western society which predisposes to many diseases, including cardiovascular disease and diabetes mellitus type 2, and lowers life expectancy.

FREE ENERGY IS THE USEFUL ENERGY IN A SYSTEM

Gibbs change in **free energy** (ΔG) is that portion of the total energy change in a system that is available for doing work—that is, the useful energy, also known as the chemical potential.

Biologic Systems Conform to the General Laws of Thermodynamics

The first law of thermodynamics states that **the total energy of a system, including its surroundings, remains constant**. It implies that within the total system, energy is neither lost nor gained during any change.

However, energy may be transferred from one part of the system to another, or may be transformed into another form of energy. In living systems, chemical energy may be transformed into heat or into electrical, radiant, or mechanical energy.

The second law of thermodynamics states that **the total entropy of a system must increase if a process is to occur spontaneously**. Entropy is the extent of disorder or randomness of the system and becomes maximum as equilibrium is approached. Under conditions of constant temperature

and pressure, the relationship between the free-energy change (ΔG) of a reacting system and the change in entropy (ΔS) is expressed by the following equation, which combines the two laws of thermodynamics:

$$\Delta G = \Delta H - T\Delta S$$

where ΔH is the change in **enthalpy** (heat) and T is the absolute temperature.

In biochemical reactions, since ΔH is approximately equal to the **total change in internal energy of the reaction or ΔE** , the above relationship may be expressed in the following way:

$$\Delta G = \Delta E - T\Delta S$$

If ΔG is negative, the reaction proceeds spontaneously with loss of free energy, that is, it is **exergonic**. If, in addition, ΔG is of great magnitude, the reaction goes virtually to completion and is essentially irreversible. On the other hand, if ΔG is positive, the reaction proceeds only if free energy can be gained, that is, it is **endergonic**. If, in addition, the magnitude of ΔG is great, the system is stable, with little or no tendency for a reaction to occur. If ΔG is zero, the system is at equilibrium and no net change takes place.

When the reactants are present in concentrations of 1.0 mol/L, ΔG^0 is the standard free-energy change. For biochemical reactions, a standard state is defined as having a pH of 7.0. The standard free-energy change at this standard state is denoted by $\Delta G^{0'}$.

The standard free-energy change can be calculated from the equilibrium constant K_{eq} .

$$\Delta G^{0'} = -RT \ln K'_{\text{eq}}$$

where R is the gas constant and T is the absolute temperature (see [Chapter 8](#)). It is important to note that the actual ΔG may be larger or smaller than $\Delta G^{0'}$ depending on the concentrations of the various reactants, including the solvent, various ions, and proteins.

In a biochemical system, an enzyme only speeds up the attainment of equilibrium; it never alters the final concentrations of the reactants at equilibrium.

ENDERGONIC PROCESSES PROCEED BY

COUPLING TO EXERGONIC PROCESSES

The vital processes—for example, synthetic reactions, muscular contraction, nerve impulse conduction, and active transport—obtain energy by chemical linkage, or **coupling**, to oxidative reactions. In its simplest form, this type of coupling may be represented as shown in **Figure 11–1**. The conversion of metabolite A to metabolite B occurs with release of free energy and is coupled to another reaction in which free energy is required to convert metabolite C to metabolite D. The terms **exergonic** and **endergonic**, rather than the normal chemical terms “exothermic” and “endothermic,” are used to indicate that a process is accompanied by loss or gain, respectively, of free energy in any form, not necessarily as heat. In practice, an endergonic process cannot exist independently, but must be a component of a coupled exergonic–endergonic system where the overall net change is exergonic. The exergonic reactions are termed **catabolism** (generally, the breakdown or oxidation of fuel molecules), whereas the synthetic reactions that build up substances are termed **anabolism**. The combined catabolic and anabolic processes constitute **metabolism**.

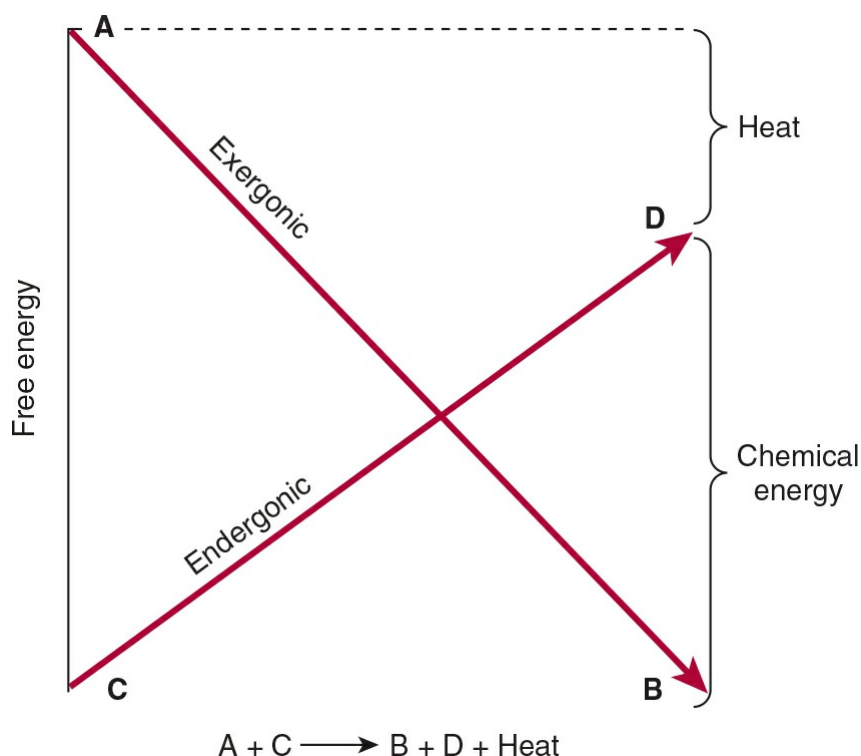
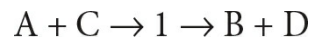

FIGURE 11–1 Coupling of an exergonic to an endergonic reaction.

If the reaction shown in **Figure 11–1** is to go from left to right, then the overall process must be accompanied by loss of free energy as heat. One

possible mechanism of coupling could be envisaged if a common obligatory intermediate (I) took part in both reactions, that is,



Some exergonic and endergonic reactions in biologic systems are coupled in this way. This type of system has a built-in mechanism for biologic control of the rate of oxidative processes since the common obligatory intermediate allows the rate of utilization of the product of the synthetic path (D) to determine by mass action the rate at which A is oxidized. Indeed, these relationships supply a basis for the concept of **respiratory control**, the process that prevents an organism from burning out of control. An extension of the coupling concept is provided by dehydrogenation reactions, which are coupled to hydrogenations by an intermediate carrier (**Figure 11-2**).

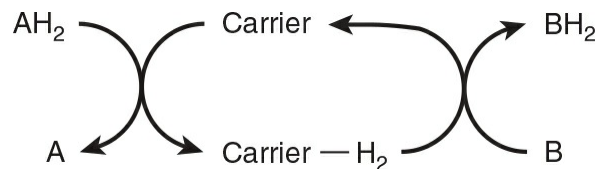

FIGURE 11-2 Coupling of dehydrogenation and hydrogenation reactions by an intermediate carrier.

An alternative method of coupling an exergonic to an endergonic process is to synthesize a compound of high-energy potential in the exergonic reaction and to incorporate this new compound into the endergonic reaction, thus effecting a transference of free energy from the exergonic to the endergonic pathway. The biologic advantage of this mechanism is that the compound of high potential energy, $\sim \text{E}$, unlike I in the previous system, need not be structurally related to A, B, C, or D, allowing E to serve as a transducer of energy from a wide range of exergonic reactions to an equally wide range of endergonic reactions or processes, such as biosyntheses, muscular contraction, nervous excitation, and active transport. In the living cell, the principal high-energy intermediate or carrier compound is **ATP** (**Figure 11-3**).

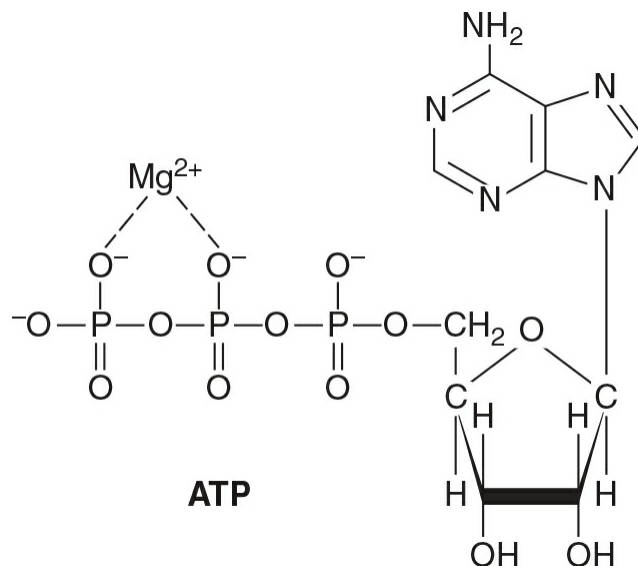

FIGURE 11–3 Adenosine triphosphate (ATP) is shown as the magnesium complex.

HIGH-ENERGY PHOSPHATES PLAY A CENTRAL ROLE IN ENERGY CAPTURE AND TRANSFER

In order to maintain living processes, all organisms must obtain supplies of free energy from their environment. **Autotrophic** organisms utilize simple exergonic processes; for example, the energy of sunlight (green plants), the reaction $\text{Fe}^{2+} \rightarrow \text{Fe}^{3+}$ (some bacteria). On the other hand, **heterotrophic** organisms obtain free energy by coupling their metabolism to the breakdown of complex organic molecules in their environment. In all these organisms, ATP plays a central role in the transference of free energy from the exergonic to the endergonic processes. ATP is a nucleotide consisting of the nucleoside adenosine (adenine linked to ribose) and three phosphate groups (see [Chapter 32](#)). In its reactions in the cell, it functions as the Mg^{2+} complex ([Figure 11–3](#)).

The importance of phosphates in intermediary metabolism became evident with the discovery of the role of ATP, adenosine diphosphate (ADP), and inorganic phosphate (P_i) in glycolysis (see [Chapter 17](#)).

The Intermediate Value for the Free Energy of Hydrolysis of ATP Has Important Bioenergetic Significance

The standard free energy of hydrolysis of a number of biochemically important phosphates is shown in **Table 11–1**. An estimate of the comparative tendency of each of the phosphate groups to transfer to a suitable acceptor may be obtained from the $\Delta G^{0'}$ of hydrolysis at 37°C. This is termed the **group transfer potential**. The value for the hydrolysis of the terminal phosphate of ATP divides the list into two groups. **Low-energy phosphates**, having a low group transfer potential, exemplified by the ester phosphates found in the intermediates of glycolysis, have $G^{0'}$ values smaller than that of ATP, while in **high-energy phosphates**, with a more negative $G^{0'}$, the value is higher than that of ATP. The components of this latter group, including ATP, are usually anhydrides (eg, the 1-phosphate of 1,3-bisphosphoglycerate), enol phosphates (eg, phosphoenolpyruvate), and phosphoguanidines (eg, creatine phosphate, arginine phosphate).

TABLE 11–1 Standard Free Energy of Hydrolysis of Some Organophosphates of Biochemical Importance

Compound	$\Delta G^{0'}$	
	kJ/mol	kcal/mol
Phosphoenolpyruvate	-61.9	-14.8
Carbamoyl phosphate	-51.4	-12.3
1,3-Bisphosphoglycerate (to 3-phosphoglycerate)	-49.3	-11.8
Creatine phosphate	-43.1	-10.3
ATP \rightarrow AMP + PP _i	-32.2	-7.7
ATP \rightarrow ADP + P _i	-30.5	-7.3
Glucose-1-phosphate	-20.9	-5.0
PP _i	-19.2	-4.6
Fructose-6-phosphate	-15.9	-3.8
Glucose-6-phosphate	-13.8	-3.3
Glycerol-3-phosphate	-9.2	-2.2

Abbreviations: PP_i, pyrophosphate; P_i, inorganic orthophosphate.

Note: All values are taken from Jencks WP: Free energies of hydrolysis and decarboxylation. In: *Handbook of Biochemistry and Molecular Biology*, vol 1. *Physical and Chemical Data*. Fasman GD (editor). CRC Press, 1976:296-304, except that for PP_i which is from Frey PA, Arabshahi A: Standard free-energy change for the hydrolysis of the alpha, beta-phosphoanhydride bridge in ATP. *Biochemistry* 1995;34:11307. Values differ between investigators, depending on the precise conditions under which the measurements were made.

The symbol ~Ⓟ indicates that the group attached to the bond, on transfer to an appropriate acceptor, results in transfer of the larger quantity of free energy. Thus, ATP has a high group transfer potential, whereas the phosphate in adenosine monophosphate (AMP) is of the low-energy type since it is a normal ester link (**Figure 11-4**). In energy transfer reactions, ATP may be converted to ADP and P_i or, in reactions requiring a greater energy input, to AMP + PP_i (**Table 11-1**).

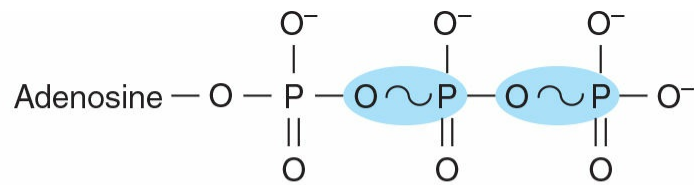

Adenosine triphosphate (ATP)

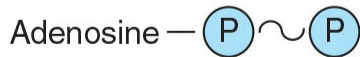

Adenosine diphosphate (ADP)



Adenosine monophosphate (AMP)

FIGURE 11–4 Structure of ATP, ADP, and AMP showing the position and the number of high-energy phosphates (~P).

The intermediate position of ATP allows it to play an important role in energy transfer. The high free-energy change on hydrolysis of ATP is due to relief of charge repulsion of adjacent negatively charged oxygen atoms and to stabilization of the reaction products, especially phosphate, as resonance hybrids (Figure 11–5). Other “high-energy compounds” are thiol esters involving coenzyme A (eg, acetyl-CoA), acyl carrier protein, amino acid esters involved in protein synthesis, S-adenosylmethionine (active methionine), uridine diphosphate glucose (UDPGlc), and 5-phosphoribosyl-1-pyrophosphate (PRPP).

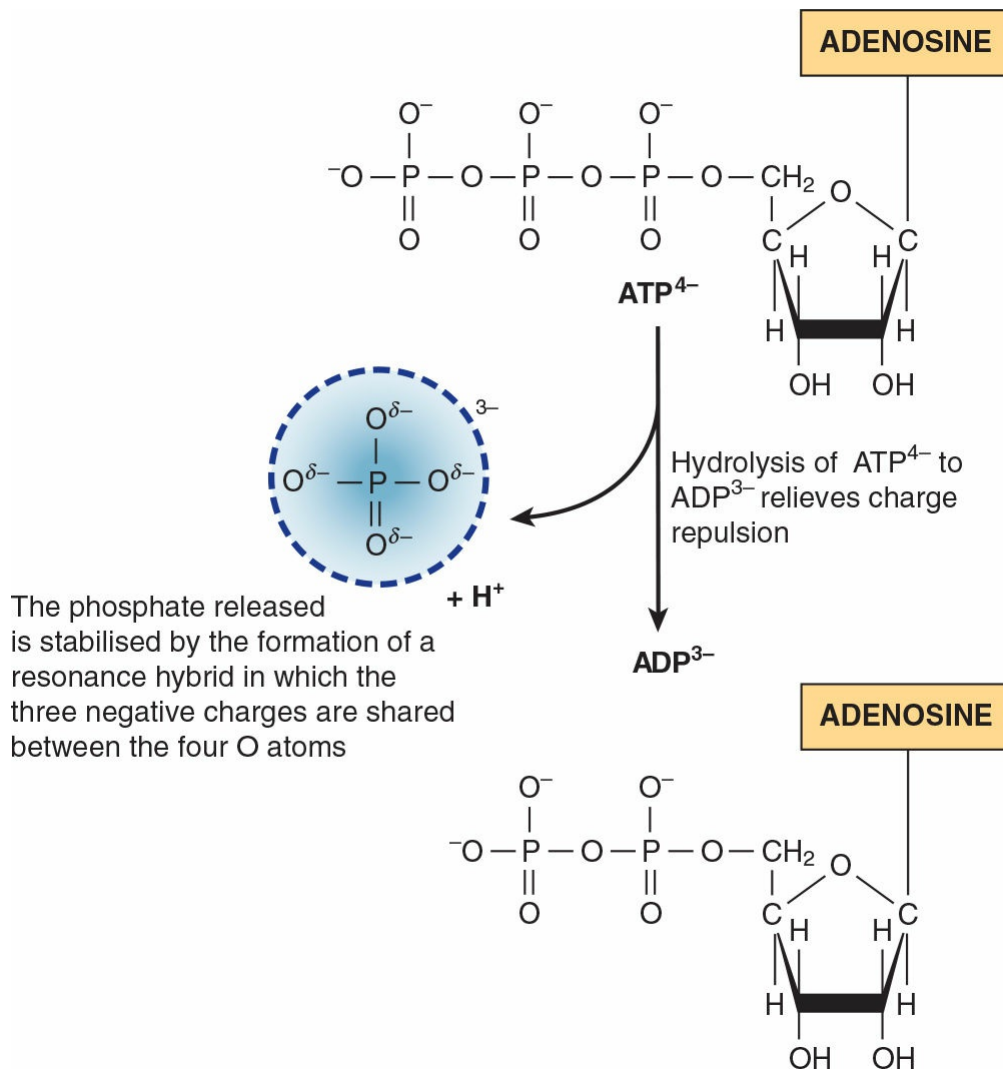

FIGURE 11–5 The free-energy change on hydrolysis of ATP to ADP.

ATP ACTS AS THE “ENERGY CURRENCY” OF THE CELL

The high group transfer potential of ATP enables it to act as a donor of high-energy phosphate to form those compounds below it in [Table 11–1](#). Likewise, with the necessary enzymes, ADP can accept phosphate groups to form ATP from those compounds above ATP in the table. In effect, an **ATP/ADP cycle** connects those processes that generate ~P to those processes that utilize ~P ([Figure 11–6](#)), continuously consuming and regenerating ATP. This occurs at a very rapid rate since the total ATP/ADP pool is extremely small and sufficient to maintain an active tissue for only a few seconds.

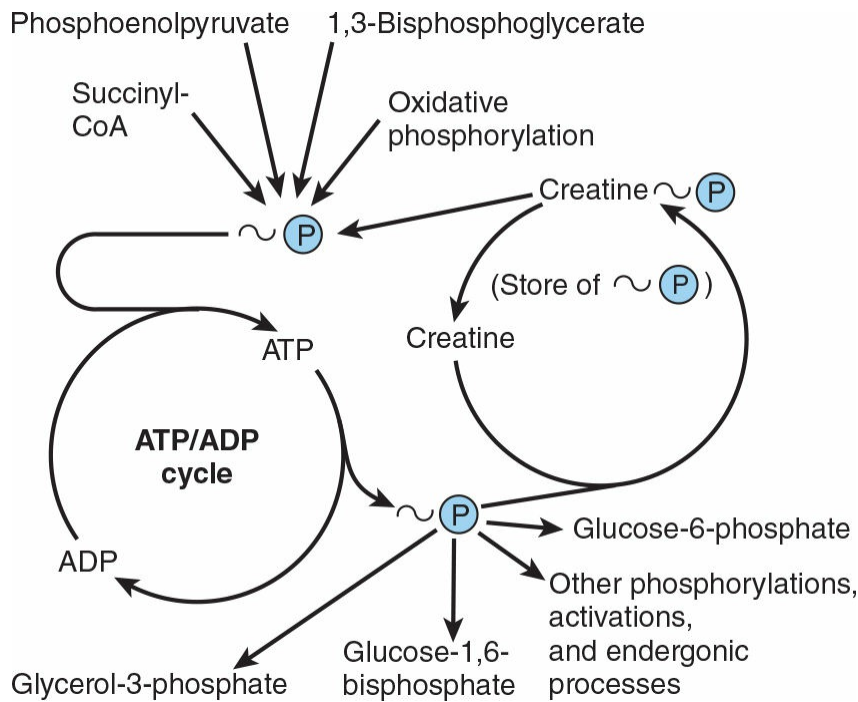

FIGURE 11–6 Role of ATP/ADP cycle in transfer of high-energy phosphate.

There are three major sources of $\sim\text{P}$ taking part in **energy conservation** or **energy capture**:

1. **Oxidative phosphorylation** is the greatest quantitative source of $\sim\text{P}$ in aerobic organisms. ATP is generated in the mitochondrial matrix as O_2 is reduced to H_2O by electrons passing down the respiratory chain (see [Chapter 13](#)).
2. **Glycolysis**. A net formation of two $\sim\text{P}$ results from the formation of lactate from one molecule of glucose, generated in two reactions catalyzed by phosphoglycerate kinase and pyruvate kinase, respectively (see [Figure 17–2](#)).
3. **The citric acid cycle**. One $\sim\text{P}$ is generated directly in the cycle at the succinate thiokinase step (see [Figure 16–3](#)).

Phosphagens act as storage forms of group transfer potential and include **creatine phosphate**, which occurs in vertebrate skeletal muscle, heart, spermatozoa, and brain, and **arginine phosphate**, which occurs in invertebrate muscle. When ATP is rapidly being utilized as a source of energy for muscular contraction, phosphagens permit its concentrations to be maintained, but when the ATP/ADP ratio is high, their concentration can increase to act as an energy store ([Figure 11–7](#)).

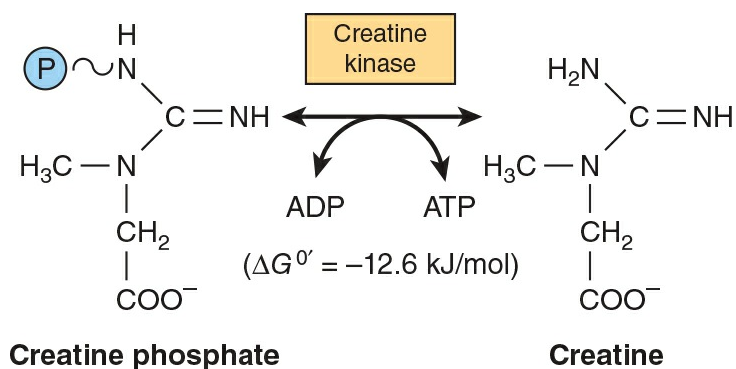
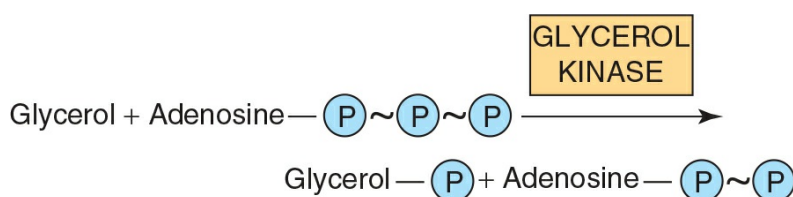

FIGURE 11–7 Transfer of high-energy phosphate between ATP and creatine.

When ATP acts as a phosphate donor to form compounds of lower free energy of hydrolysis (Table 11–1), the phosphate group is invariably converted to one of low energy. For example, the phosphorylation of glycerol to form glycerol-3-phosphate:



ATP Allows the Coupling of Thermodynamically Unfavorable Reactions to Favorable Ones

Endergonic reactions cannot proceed without an input of free energy. For example, the phosphorylation of glucose to glucose-6-phosphate, the first reaction of glycolysis (see Figure 17–2):

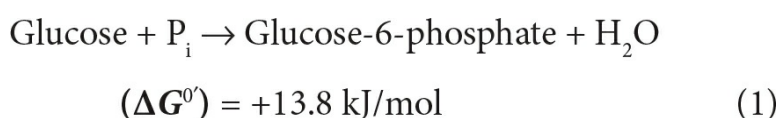

is highly endergonic and cannot proceed under physiologic conditions. Thus, in order to take place, the reaction must be coupled with another—more exergonic—reaction such as the hydrolysis of the terminal phosphate of ATP.

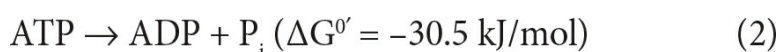

When (1) and (2) are coupled in a reaction catalyzed by hexokinase, phosphorylation of glucose readily proceeds in a highly exergonic reaction that under physiologic conditions is irreversible. Many “activation”

reactions follow this pattern.

Adenylyl Kinase (Myokinase) Interconverts Adenine Nucleotides

This enzyme is present in most cells. It catalyzes the following reaction:



Adenylyl kinase is important for the maintenance of energy homeostasis in cells because it allows:

1. The group transfer potential in ADP to be used in the synthesis of ATP.
2. The AMP formed as a consequence of activating reactions involving ATP to rephosphorylated to ADP.
3. AMP to increase in concentration when ATP becomes depleted so that it is able to act as a metabolic (allosteric) signal to increase the rate of catabolic reactions, which in turn lead to the generation of more ATP (see [Chapter 14](#)).

When ATP Forms AMP, Inorganic Pyrophosphate (PP_i) Is Produced

ATP can also be hydrolyzed directly to AMP, with the release of PP_i ([Table 11–1](#)). This occurs, for example, in the activation of long-chain fatty acids (see [Chapter 22](#)).

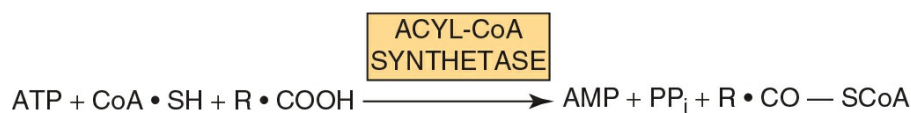

This reaction is accompanied by loss of free energy as heat, which ensures that the activation reaction will go to the right, and is further aided by the hydrolytic splitting of PP_i, catalyzed by **inorganic pyrophosphatase**, a reaction that itself has a large $\Delta G^{0'}$ of -19.2 kJ/mol. Note that activations via the pyrophosphate pathway result in the loss of two $\sim\text{P}$ rather than one, as occurs when ADP and P_i are formed.

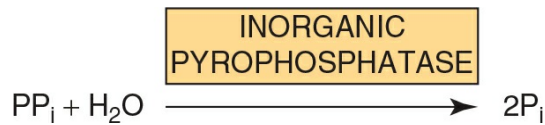

A combination of the above reactions makes it possible for phosphate to be recycled and the adenine nucleotides to interchange (**Figure 11–8**).

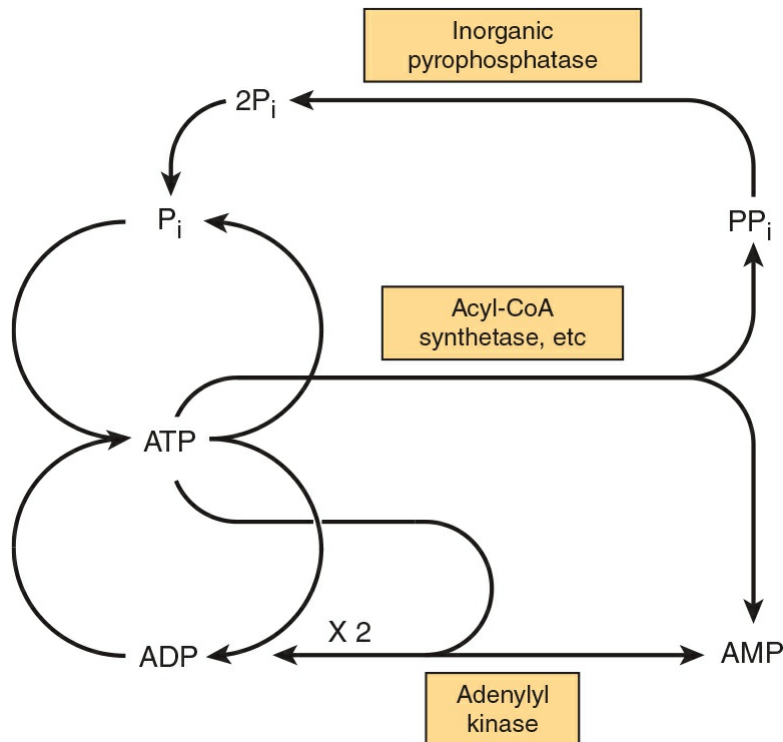
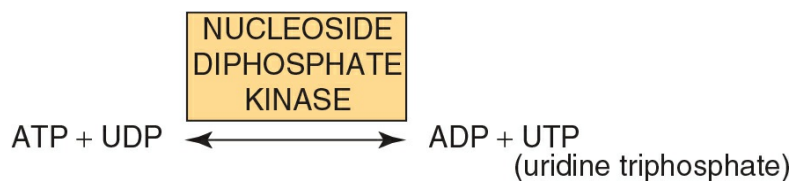

FIGURE 11–8 Phosphate cycles and interchange of adenine nucleotides.

Other Nucleoside Triphosphates Participate in Group Transfer Potential

By means of the **nucleoside diphosphate (NDP) kinases**, UTP, GTP, and CTP can be synthesized from their diphosphates, for example, UDP reacts with ATP to form UTP.



All of these triphosphates take part in phosphorylations in the cell. Similarly, specific **nucleoside monophosphate (NMP) kinases** catalyze

the formation of NDP from the corresponding monophosphates.

Thus, Adenylyl kinase is a specialized NMP kinase.

SUMMARY

- Biologic systems use chemical energy to power living processes.
- Exergonic reactions take place spontaneously with loss of free energy (ΔG is negative). Endergonic reactions require the gain of free energy (ΔG is positive) and occur only when coupled to exergonic reactions.
- ATP acts as the “energy currency” of the cell, transferring free energy derived from substances of higher energy potential to those of lower energy potential.

REFERENCES

Haynie D: *Biological Thermodynamics*. Cambridge University Press, 2008.

Nicholls DG, Ferguson S: *Bioenergetics*, 4th ed. Academic Press, 2013.

Biologic Oxidation

Kathleen M. Botham, PhD, DSc & Peter A. Mayes, PhD, DSc

OBJECTIVES

After studying this chapter, you should be able to:

- Explain the meaning of redox potential and how it can be used to predict the direction of flow of electrons in biologic systems.
- Identify the four classes of enzymes (oxidoreductases) involved in oxidation and reduction reactions.
- Describe the action of oxidases and provide examples of where they play an important role in metabolism.
- Indicate the two main functions of dehydrogenases and explain the importance of nicotinamide adenine dinucleotide (NAD)- and riboflavin-linked dehydrogenases in metabolic pathways such as glycolysis, the citric acid cycle, and the respiratory chain.
- Identify the two types of enzymes classified as hydroperoxidases; indicate the reactions they catalyze and explain why they are important.
- Give the two steps of reactions catalyzed by oxygenases and identify the two subgroups of this class of enzymes.
- Appreciate the role of cytochrome P450 in drug detoxification and steroid synthesis.

- Describe the reaction catalyzed by superoxide dismutase and explain how it protects tissues from oxygen toxicity.

BIOMEDICAL IMPORTANCE

Chemically, **oxidation** is defined as the removal of electrons and **reduction** as the gain of electrons. Thus, oxidation of a molecule (the electron donor) is always accompanied by reduction of a second molecule (the electron acceptor). This principle of oxidation–reduction applies equally to biochemical systems and is an important concept underlying understanding of the nature of biologic oxidation. Note that many biologic oxidations can take place without the participation of molecular oxygen, for example, dehydrogenations. The life of higher animals is absolutely dependent on a supply of oxygen for **respiration**, the process by which cells derive energy in the form of ATP from the controlled reaction of hydrogen with oxygen to form water. In addition, molecular oxygen is incorporated into a variety of substrates by enzymes designated as **oxygenases**; many drugs, pollutants, and chemical carcinogens (xenobiotics) are metabolized by enzymes of this class, known as the **cytochrome P450 system**. Administration of oxygen can be lifesaving in the treatment of patients with respiratory or circulatory failure.

FREE ENERGY CHANGES CAN BE EXPRESSED IN TERMS OF REDOX POTENTIAL

In reactions involving oxidation and reduction, the free energy change is proportionate to the tendency of reactants to donate or accept electrons. Thus, in addition to expressing free energy change in terms of $\Delta G^{0'}$ (see [Chapter 11](#)), it is possible, in an analogous manner, to express it numerically as an **oxidation–reduction** or **redox potential** (E'_0).

Chemically, the redox potential of a system (E_0) is usually compared with the potential of the hydrogen electrode (0.0 V at pH 0.0). However, for biologic systems, the redox potential (E'_0) is normally expressed at pH 7.0, at which pH the electrode potential of the hydrogen electrode is -0.42 V. The redox potentials of some redox systems of special interest in mammalian biochemistry are shown in [Table 12–1](#). The relative positions of redox systems in the table allow prediction of the direction of flow of electrons from one redox couple to another.

TABLE 12–1 Some Redox Potentials of Special Interest in Mammalian Oxidation Systems

System	E'_0 Volts
H ⁺ /H ₂	-0.42
NAD ⁺ /NADH	-0.32
Lipoate; ox/red	-0.29
Acetoacetate/3-hydroxybutyrate	-0.27
Pyruvate/lactate	-0.19
Oxaloacetate/malate	-0.17
Fumarate/succinate	+0.03
Cytochrome <i>b</i> ; Fe ³⁺ /Fe ²⁺	+0.08
Ubiquinone; ox/red	+0.10
Cytochrome <i>c</i> ₁ ; Fe ³⁺ /Fe ²⁺	+0.22
Cytochrome <i>a</i> ; Fe ³⁺ /Fe ²⁺	+0.29
Oxygen/water	+0.82

Enzymes involved in oxidation and reduction are called **oxidoreductases** and are classified into four groups: **oxidases**, **dehydrogenases**, **hydroperoxidases**, and **oxygenases**.

OXIDASES USE OXYGEN AS A HYDROGEN ACCEPTOR

Oxidases catalyze the removal of hydrogen from a substrate using oxygen as a hydrogen acceptor.* They form water or hydrogen peroxide as a reaction product (**Figure 12–1**).

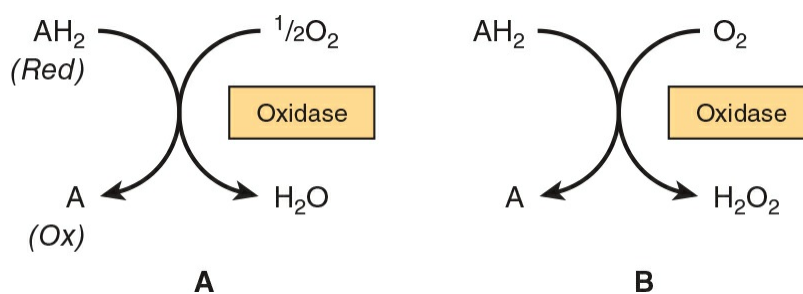

FIGURE 12–1 Oxidation of a metabolite catalyzed by an oxidase (A) forming H₂O and (B) forming H₂O₂.

Cytochrome Oxidase Is a Hemoprotein

Cytochrome oxidase is a hemoprotein widely distributed in many tissues, having the typical heme prosthetic group present in myoglobin, hemoglobin, and other cytochromes (see [Chapter 6](#)). It is the terminal component of the chain of respiratory carriers found in mitochondria (see [Chapter 13](#)) and transfers electrons resulting from the oxidation of substrate molecules by dehydrogenases to their final acceptor, oxygen. The action of the enzyme is blocked by **carbon monoxide, cyanide, and hydrogen sulfide**, and this causes poisoning by preventing cellular respiration. The cytochrome oxidase enzyme complex comprises heme *a*₃ combined with another heme, heme *a*, in a single protein and so is also termed **cytochrome aa₃**. It contains two molecules of heme, each having one Fe atom that oscillates between Fe³⁺ and Fe²⁺ during oxidation and reduction. Furthermore, two atoms of copper are present, one associated with each heme unit.

Other Oxidases Are Flavoproteins

Flavoprotein enzymes contain **flavin mononucleotide (FMN)** or **flavin adenine dinucleotide (FAD)** as prosthetic groups. FMN and FAD are formed in the body from the vitamin **riboflavin** (see [Chapter 44](#)). FMN and FAD are usually tightly—but not covalently—bound to their respective apoenzyme proteins. Metalloflavoproteins contain one or more metals as essential cofactors. Examples of flavoprotein oxidases include **L-amino acid oxidase**, an enzyme found in kidney with general specificity for the oxidative deamination of the naturally occurring L-amino acids; **xanthine oxidase**, which contains molybdenum and plays an important role in the conversion of purine bases to uric acid (see [Chapter 33](#)), and is of particular significance in uricotelic animals (see [Chapter 28](#)); and **aldehyde dehydrogenase**, an FAD-linked enzyme present in mammalian livers, which contains molybdenum and nonheme iron and acts on aldehydes and *N*-heterocyclic substrates. The mechanisms of oxidation and reduction of these enzymes are complex. Evidence suggests a two-step reaction as shown in [Figure 12–2](#).

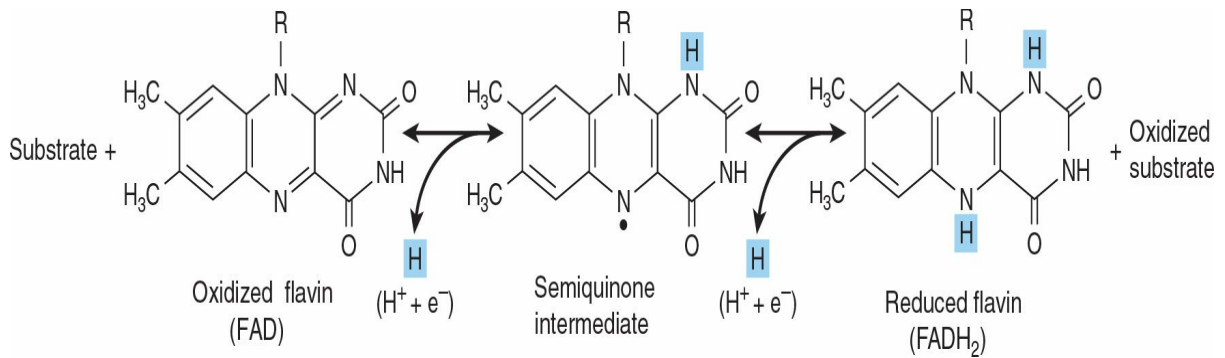

FIGURE 12–2 Oxidoreduction of isoalloxazine ring in flavin nucleotides via a semiquinone intermediate. In oxidation reactions, the flavin (eg, FAD) accepts two electrons and two H⁺ in two steps, forming the semiquinone intermediate followed by the reduced flavin (eg, FADH₂) and the substrate is oxidized. In the reverse (reduction) reaction, the reduced flavin gives up two electrons and two H⁺ so that it becomes oxidized (eg, to FAD) and the substrate is reduced.

DEHYDROGENASES PERFORM TWO MAIN FUNCTIONS

There are a large number of enzymes in the dehydrogenase class. Their two main functions are as follows:

1. Transfer of hydrogen from one substrate to another in a coupled oxidation–reduction reaction (**Figure 12–3**). These dehydrogenases often utilize common coenzymes or hydrogen carriers, for example, nicotinamide adenine dinucleotide (NAD⁺). This type of reaction in which one substrate is oxidized/reduced at the expense of another is freely reversible, enabling reducing equivalents to be transferred within the cell and oxidative processes to occur in the absence of oxygen, such as during the anaerobic phase of glycolysis (see **Figure 17–2**).

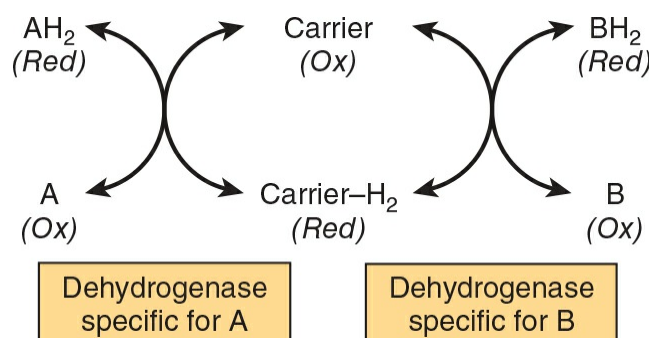

FIGURE 12–3 Oxidation of a metabolite catalyzed by coupled dehydrogenases.

2. Transfer of electrons in the **respiratory chain** of electron transport from substrate to oxygen (see [Figure 13–3](#)).

Many Dehydrogenases Depend on Nicotinamide Coenzymes

These dehydrogenases use NAD^+ or **nicotinamide adenine dinucleotide phosphate (NADP⁺)**—or both—which are formed in the body from the vitamin **niacin** (see [Chapter 44](#)). The structure of NAD^+ is shown in [Figure 12–4](#). NADP^+ has a phosphate group esterified to the 2' hydroxyl of its adenosine moiety, but otherwise is identical to NAD^+ . The oxidized forms of both nucleotides have a positive charge on the nitrogen atom of the nicotinamide moiety as indicated in [Figure 12–4](#). The coenzymes are reduced by the specific substrate of the dehydrogenase and reoxidized by a suitable electron acceptor. They are able to freely and reversibly dissociate from their respective apoenzymes.

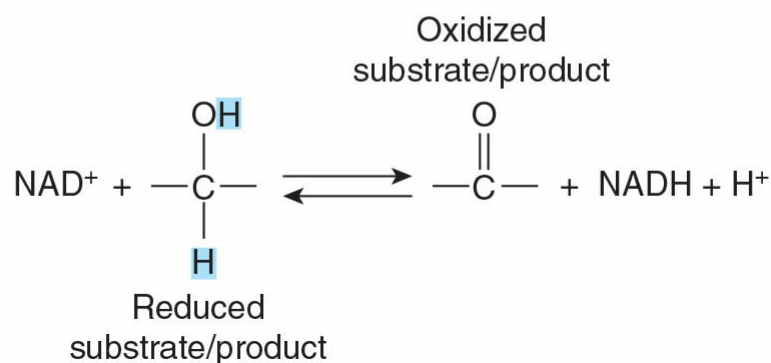
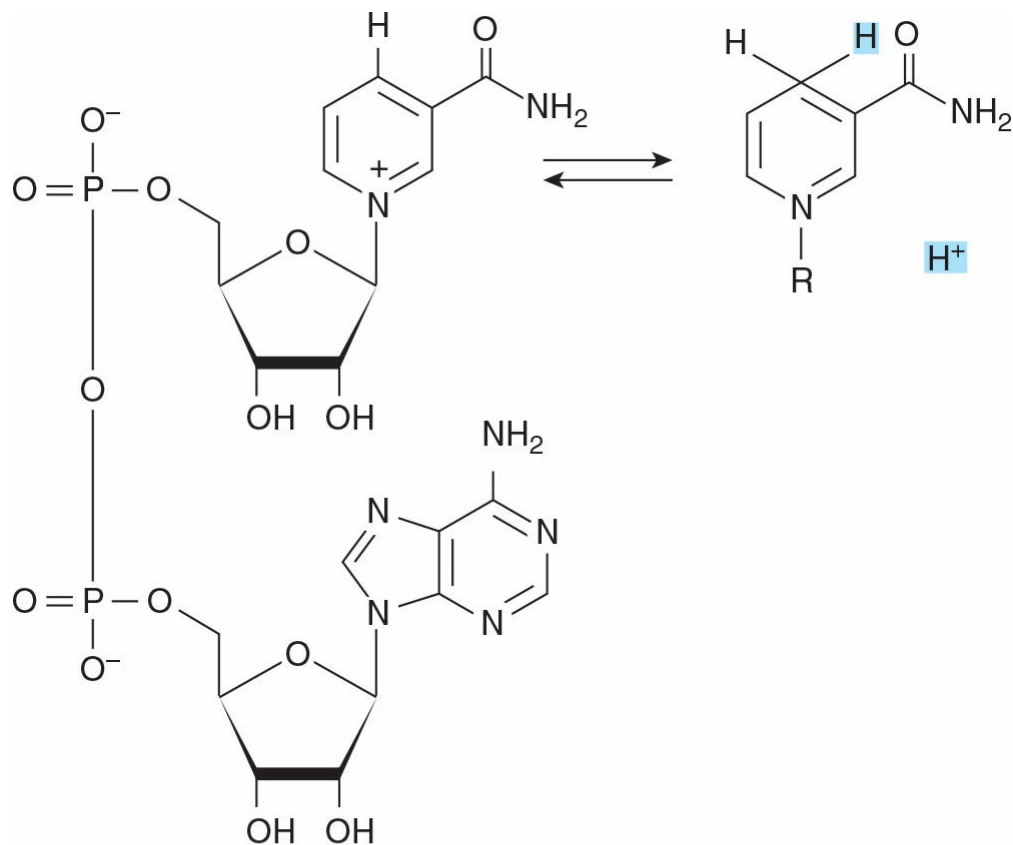
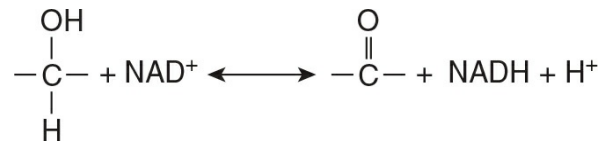

FIGURE 12–4 Oxidation and reduction of nicotinamide coenzymes. Nicotinamide coenzymes consist of a nicotinamide ring linked to an adenosine via a ribose and a phosphate group, forming a dinucleotide. NAD^+/NADH are shown, but $\text{NADP}^+/\text{NADPH}$ are identical except that they have a phosphate group esterified to the 2' OH of the adenosine. An oxidation reaction involves the transfer of two electrons and one H^+ from the substrate to the nicotinamide ring of NAD^+ forming NADH and the oxidized product. The remaining hydrogen of the hydrogen pair removed from the substrate remains free as a hydrogen ion. NADH is oxidized to NAD^+ by the reverse reaction.

Generally, **NAD-linked dehydrogenases** catalyze oxidoreduction reactions of the type:



When a substrate is oxidized, it loses two hydrogen atoms and two electrons. One H^+ and both electrons are accepted by NAD^+ to form NADH and the other H^+ is released (Figure 12–4). Many such reactions occur in the oxidative pathways of metabolism, particularly in glycolysis (see Chapter 17) and the citric acid cycle (see Chapter 16). NADH is generated in these pathways via the oxidation of fuel molecules, and NAD^+ is regenerated by the oxidation of NADH as it transfers the electrons to O_2 via the respiratory chain in mitochondria, a process which leads to the formation of ATP (see Chapter 13). **NADP-linked dehydrogenases** are found characteristically in biosynthetic pathways where reductive reactions are required, as in the extramitochondrial pathway of fatty acid synthesis (see Chapter 23) and steroid synthesis (see Chapter 26)—and also in the pentose phosphate pathway (see Chapter 20).

Other Dehydrogenases Depend on Riboflavin

The **flavin groups such as FMN and FAD** are associated with dehydrogenases as well as with oxidases as described above. FAD is the electron acceptor in reactions of the type:

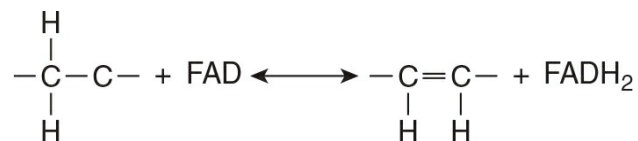

FAD accepts two electrons and two H^+ in the reaction (Figure 12–2), forming FADH_2 . Flavin groups are generally more tightly bound to their apoenzymes than are the nicotinamide coenzymes. Most of the **riboflavin-linked dehydrogenases** are concerned with electron transport in (or to) the respiratory chain (see Chapter 13). **NADH dehydrogenase** acts as a carrier of electrons between NADH and the components of higher redox potential (see Figure 13–3). Other dehydrogenases such as **succinate dehydrogenase**, **acyl-CoA dehydrogenase**, and **mitochondrial glycerol-3-phosphate dehydrogenase** transfer reducing equivalents directly from

the substrate to the respiratory chain (see [Figure 13–5](#)). Another role of the flavin-dependent dehydrogenases is in the dehydrogenation (by **dihydrolipoyl dehydrogenase**) of reduced lipoate, an intermediate in the oxidative decarboxylation of pyruvate and α -ketoglutarate (see [Figures 13–5](#) and [17–5](#)). The **electron-transferring flavoprotein (ETF)** is an intermediary carrier of electrons between acyl-CoA dehydrogenase and the respiratory chain (see [Figure 13–5](#)).

Cytochromes May Also Be Regarded as Dehydrogenases

The **cytochromes** are iron-containing hemoproteins in which the iron atom oscillates between Fe^{3+} and Fe^{2+} during oxidation and reduction. Except for cytochrome oxidase (previously described), they are classified as dehydrogenases. In the respiratory chain, they are involved as carriers of electrons from flavoproteins on the one hand to cytochrome oxidase on the other (see [Figure 13–5](#)). Several identifiable cytochromes occur in the respiratory chain, that is, cytochromes *b*, *c*₁, *c*, and cytochrome oxidase (*aa*₃). Cytochromes are also found in other locations, for example, the endoplasmic reticulum (cytochromes P450 and *b*₅), and in plant cells, bacteria, and yeasts.

HYDROPEROXIDASES USE HYDROGEN PEROXIDE OR AN ORGANIC PEROXIDE AS SUBSTRATE

Two types of enzymes found both in animals and plants fall into the **hydroperoxidase** category: **peroxidases** and **catalase**.

Hydroperoxidases play an important role in protecting the body against the harmful effects of **reactive oxygen species (ROS)**. ROS are highly reactive oxygen-containing molecules such as peroxides, which are formed during normal metabolism, but can be damaging if they accumulate. They are believed to contribute to the causation of diseases such as cancer and atherosclerosis, as well as the aging process in general (see [Chapters 21](#), [44](#), [54](#)).

Peroxidases Reduce Peroxides Using Various Electron Acceptors

Peroxidases are found in milk and in leukocytes, platelets, and other tissues involved in eicosanoid metabolism (see [Chapter 23](#)). Their prosthetic group is **protoheme**. In the reaction catalyzed by peroxidase, hydrogen peroxide is reduced at the expense of several substances that act as electron acceptors, such as ascorbate (vitamin C), quinones, and cytochrome *c*. The reaction catalyzed by peroxidase is complex, but the overall reaction is as follows:

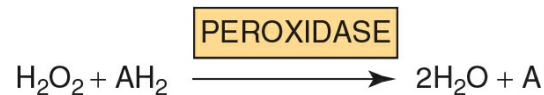

In erythrocytes and other tissues, the enzyme **glutathione peroxidase**, containing **selenium** as a prosthetic group, catalyzes the destruction of H_2O_2 and lipid hydroperoxides through the conversion of reduced glutathione to its oxidized form, protecting membrane lipids and hemoglobin against oxidation by peroxides (see [Chapter 21](#)).

Catalase Uses Hydrogen Peroxide as Electron Donor & Electron Acceptor

Catalase is a hemoprotein containing four heme groups. It can act as a peroxidase, catalyzing reactions of the type shown above, but it is also able to catalyze the breakdown of H_2O_2 formed by the action of oxygenases to water and oxygen:



This reaction uses one molecule of H_2O_2 as a substrate electron donor and another molecule of H_2O_2 as an oxidant or electron acceptor. It is one of the fastest enzyme reactions known, destroying millions of potentially damaging H_2O_2 molecules per second. Under most conditions in vivo, the peroxidase activity of catalase seems to be favored. Catalase is found in blood, bone marrow, mucous membranes, kidney, and liver. **Peroxisomes** are found in many tissues, including liver. They are rich in oxidases and in catalase. Thus, the enzymes that produce H_2O_2 are grouped with the enzyme that breaks it down. However, mitochondrial and microsomal electron transport systems as well as xanthine oxidase must be considered as additional sources of H_2O_2 .

OXYGENASES CATALYZE THE DIRECT TRANSFER & INCORPORATION OF OXYGEN INTO A SUBSTRATE MOLECULE

Oxygenases are concerned with the synthesis or degradation of many different types of metabolites. They catalyze the incorporation of oxygen into a substrate molecule in two steps: (1) oxygen is bound to the enzyme at the active site and (2) the bound oxygen is reduced or transferred to the substrate. Oxygenases may be divided into two subgroups, dioxygenases and monooxygenases.

Dioxygenases Incorporate Both Atoms of Molecular Oxygen into the Substrate

The basic reaction catalyzed by dioxygenases is shown below:

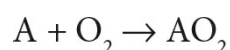

Examples include the liver enzymes, **homogentisate dioxygenase** (oxidase) and **3-hydroxyanthranilate dioxygenase** (oxidase), which contain iron; and **L-tryptophan dioxygenase** (tryptophan pyrrolase) (see [Chapter 29](#)), which utilizes heme.

Monooxygenases (Mixed-Function Oxidases, Hydroxylases) Incorporate Only One Atom of Molecular Oxygen Into the Substrate

The other oxygen atom is reduced to water, an additional electron donor or cosubstrate (Z) being necessary for this purpose:

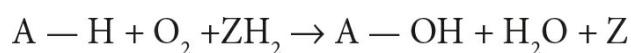

Cytochromes P450 Are Monooxygenases Important in Steroid Metabolism & for the Detoxification of Many Drugs

Cytochromes P450 are an important superfamily of heme-containing monooxygenases, and more than 50 such enzymes have been found in the human genome. They are located mainly in the endoplasmic reticulum in the liver and intestine, but are also found in the mitochondria in some

tissues. The cytochromes participate in an electron transport chain in which both NADH and NADPH may donate reducing equivalents. Electrons are passed to cytochrome P450 in two types of reaction involving FAD or FMN. Class I systems consist of an FAD-containing reductase enzyme, an iron sulfur (Fe_2S_2) protein, and the P450 heme protein, while class II systems contain cytochrome P450 reductase, which passes electrons from FADH_2 to FMN (**Figure 12–5**). Class I and II systems are well characterized, but in recent years, other cytochromes P450, which do not fit into either category, have been identified. In the final step, oxygen accepts the electrons from cytochrome P450 and is reduced, with one atom being incorporated into H_2O and the other into the substrate, usually resulting in its hydroxylation. This series of enzymatic reactions, known as the **hydroxylase cycle**, is illustrated in **Figure 12–6**. In the endoplasmic reticulum of the liver, cytochromes P450 are found together with another heme-containing protein, **cytochrome b_5** (**Figure 12–5**) and together they have a major role in drug metabolism and detoxification. Cytochrome b_5 also has an important role as a fatty acid desaturase. Together, cytochromes P450 and b_5 are responsible for about 75% of the modification and degradation of drugs, which occurs in the body. The rate of detoxification of many medicinal drugs by cytochromes P450 determines the duration of their action. Benzpyrene, aminopyrine, aniline, morphine, and benzphetamine are hydroxylated, increasing their solubility and aiding their excretion. Many drugs such as phenobarbital have the ability to induce the synthesis of cytochromes P450.

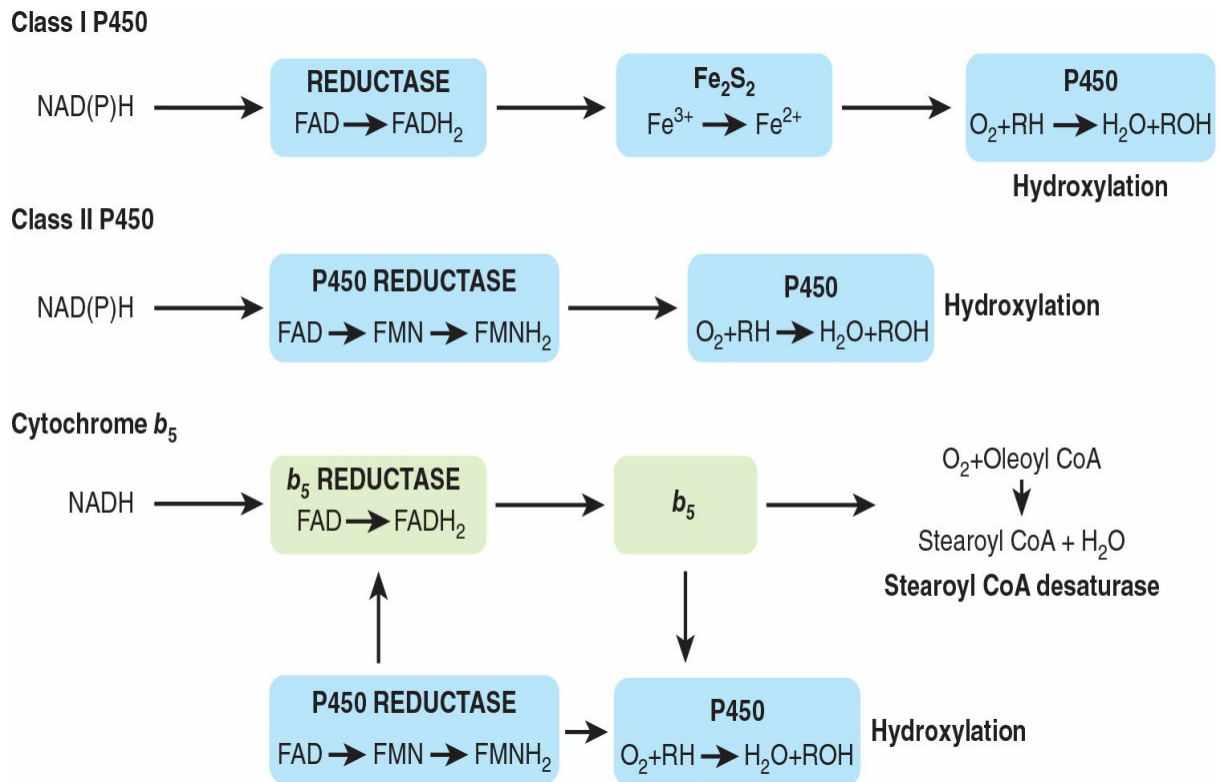

FIGURE 12–5 Cytochromes P450 and b₅ in the endoplasmic reticulum. Most cytochromes P450 are class I or class II. In addition to cytochrome P450, class I systems contain a small FAD-containing reductase and an iron sulfur protein, and class II contains cytochrome P450 reductase, which incorporates FAD and FMN. Cytochromes P450 catalyze many steroid hydroxylation reactions and drug detoxification steps. Cytochrome b₅ acts in conjunction with the FAD-containing cytochrome b₅ reductase in the fatty acyl-CoA desaturase (eg, stearoyl-CoA desaturase) reaction and also works together with cytochromes P450 in drug detoxification. It is able to accept electrons from cytochrome P450 reductase via cytochrome b₅ reductase and donate them to cytochrome P450.

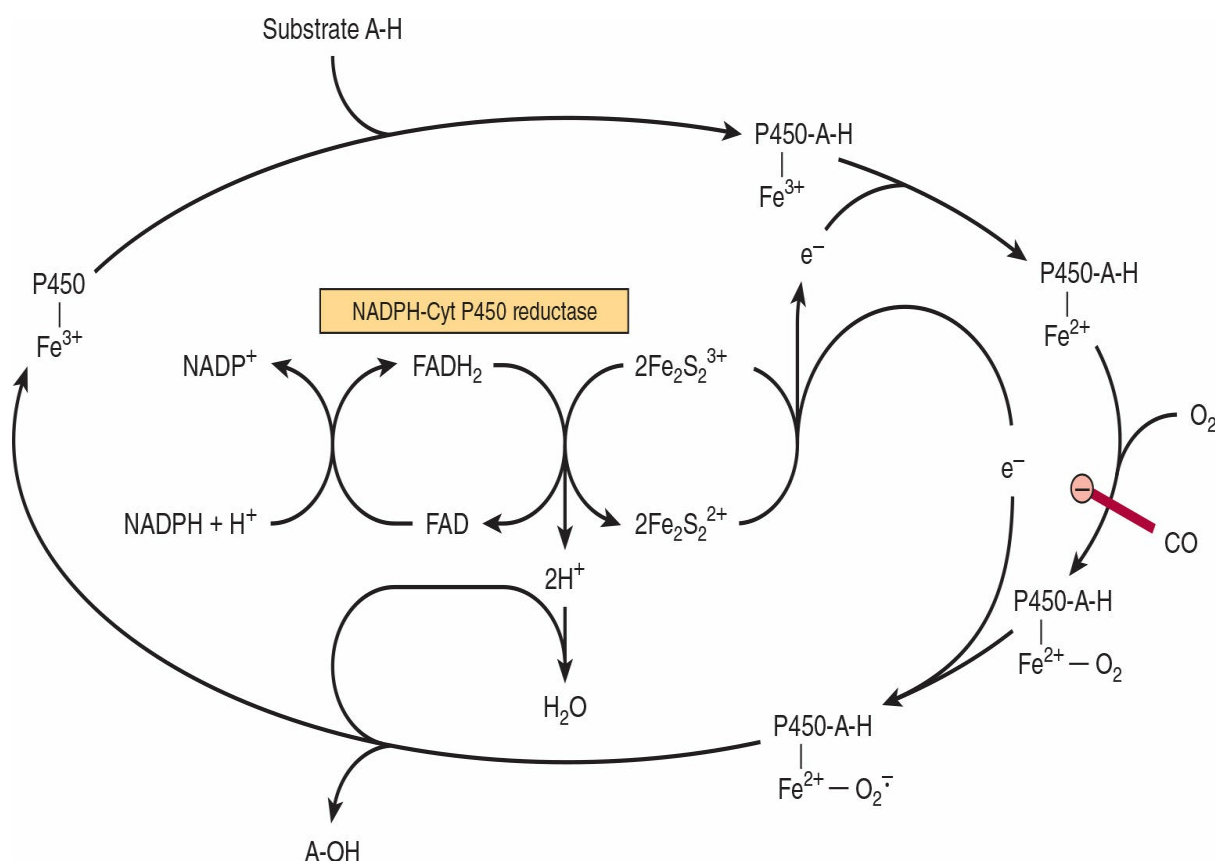

FIGURE 12–6 Cytochrome P450 hydroxylase cycle. The system shown is typical of steroid hydroxylases of the adrenal cortex. Liver microsomal cytochrome P450 hydroxylase does not require the iron-sulfur protein Fe_2S_2 . Carbon monoxide (CO) inhibits the indicated step.

Mitochondrial cytochrome P450 systems are found in steroidogenic tissues such as adrenal cortex, testis, ovary, and placenta and are concerned with the biosynthesis of steroid hormones from cholesterol (hydroxylation at C_{22} and C_{20} in side-chain cleavage and at the 11β and 18 positions). In addition, renal systems catalyzing 1α - and 24-hydroxylations of 25-hydroxycholecalciferol in vitamin D metabolism—and cholesterol 7α -hydroxylase and sterol 27-hydroxylase involved in bile acid biosynthesis from cholesterol in the liver (see [Chapters 26, 41](#))—are P450 enzymes.

SUPEROXIDE DISMUTASE PROTECTS AEROBIC ORGANISMS AGAINST OXYGEN TOXICITY

Transfer of a single electron to O_2 generates the potentially damaging

superoxide anion-free radical (O_2^-), which gives rise to free-radical chain reactions (see [Chapter 21](#)), amplifying its destructive effects. The ease with which superoxide can be formed from oxygen in tissues and the occurrence of **superoxide dismutase (SOD)**, the enzyme responsible for its removal in all aerobic organisms (although not in obligate anaerobes), indicate that the potential toxicity of oxygen is due to its conversion to superoxide.

Superoxide is formed when reduced flavins—present, for example, in xanthine oxidase—are reoxidized univalently by molecular oxygen:



Superoxide can reduce oxidized cytochrome *c*

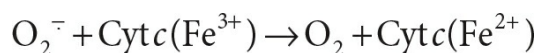

or be removed by superoxide dismutase, which catalyzes the conversion of to oxygen and hydrogen peroxide.

In this reaction, superoxide acts as both oxidant and reductant. Thus, superoxide dismutase protects aerobic organisms against the potential deleterious effects of superoxide. The enzyme occurs in all major aerobic tissues in the mitochondria and the cytosol. Although exposure of animals to an atmosphere of 100% oxygen causes an adaptive increase in SOD, particularly in the lungs, prolonged exposure leads to lung damage and death. Antioxidants, for example, α -tocopherol (vitamin E), act as scavengers of free radicals and reduce the toxicity of oxygen (see [Chapter 44](#)).

SUMMARY

- In biologic systems, as in chemical systems, oxidation (loss of electrons) is always accompanied by reduction of an electron acceptor.
- Oxidoreductases have a variety of functions in metabolism; oxidases and dehydrogenases play major roles in respiration; hydroperoxidases protect the body against damage by free radicals; and oxygenases mediate the hydroxylation of drugs and steroids.
- Tissues are protected from oxygen toxicity caused by the superoxide free radical by the specific enzyme superoxide dismutase.

REFERENCES

Nelson DL, Cox MM: *Lehninger Principles of Biochemistry*, 6th ed. Macmillan Higher Education, 2013.

Nicholls DG, Ferguson SJ: *Bioenergetics*, 4th ed. Academic Press, 2013.

*The term “oxidase” is sometimes used collectively to denote all enzymes that catalyze reactions involving molecular oxygen.

The Respiratory Chain & Oxidative Phosphorylation

Kathleen M. Botham, PhD, DSc & Peter A. Mayes, PhD, DSc

OBJECTIVES

After studying this chapter, you should be able to:

- Describe the double membrane structure of mitochondria and indicate the location of various enzymes.
- Appreciate that energy from the oxidation of fuel substrates (fats, carbohydrates, amino acids) is almost all generated in mitochondria via a process termed electron transport in which electrons pass through a series of complexes (the respiratory chain) until they are finally reacted with oxygen to form water.
- Describe the four protein complexes involved in the transfer of electrons through the respiratory chain and explain the roles of flavoproteins, iron-sulfur proteins, and coenzyme Q.
- Explain how coenzyme Q accepts electrons from NADH via Complex I and from FADH₂ via Complex II.
- Indicate how electrons are passed from reduced coenzyme Q to cytochrome *c* via Complex III in the Q cycle.
- Explain the process by which reduced cytochrome *c* is oxidized

and oxygen is reduced to water via Complex IV.

- Describe how electron transport generates a proton gradient across the inner mitochondrial membrane, leading to the buildup of a proton motive force that generates ATP by the process of oxidative phosphorylation.
- Describe the structure of the ATP synthase enzyme and explain how it works as a rotary motor to produce ATP from ADP and Pi.
- Explain that oxidation of reducing equivalents via the respiratory chain and oxidative phosphorylation are tightly coupled in most circumstances, so that one cannot proceed unless the other is functioning.
- Indicate examples of common poisons that block respiration or oxidative phosphorylation and identify their site of action.
- Explain, with examples, how uncouplers may act as poisons by dissociating oxidation via the respiratory chain from oxidative phosphorylation, but may also have a physiologic role in generating body heat.
- Explain the role of exchange transporters present in the inner mitochondrial membrane in allowing ions and metabolites to pass through while preserving electrochemical and osmotic equilibrium.

BIOMEDICAL IMPORTANCE

Aerobic organisms are able to capture a far greater proportion of the available free energy of respiratory substrates than anaerobic organisms. Most of this takes place inside **mitochondria**, which have been termed the “powerhouses” of the cell. Respiration is coupled to the generation of the high-energy intermediate, ATP (see [Chapter 11](#)), by **oxidative phosphorylation**. A number of drugs (eg, **amobarbital**) and poisons (eg, **cyanide, carbon monoxide**) inhibit oxidative phosphorylation, usually with fatal consequences. Several inherited defects of mitochondria involving components of the respiratory chain and oxidative phosphorylation have been reported. Patients present with **myopathy** and **encephalopathy** and often have **lactic acidosis**.

SPECIFIC ENZYMES ARE ASSOCIATED WITH COMPARTMENTS SEPARATED BY THE

MITOCHONDRIAL MEMBRANES

The mitochondrial **matrix** (the internal compartment) is enclosed by a **double membrane**. The **outer membrane** is permeable to most metabolites and the **inner membrane** is selectively permeable (**Figure 13–1**). The outer membrane is characterized by the presence of various enzymes, including **acyl-CoA synthetase** (see **Chapter 22**) and **glycerol phosphate acyltransferase** (see **Chapter 24**). Other enzymes, including **adenylyl kinase** (see **Chapter 11**) and **creatine kinase** (see **Chapter 51**) are found in **the intermembrane space**. The phospholipid **cardiolipin** is concentrated in the inner membrane together with the enzymes of **the respiratory chain**, **ATP synthase**, and various **membrane transporters**.

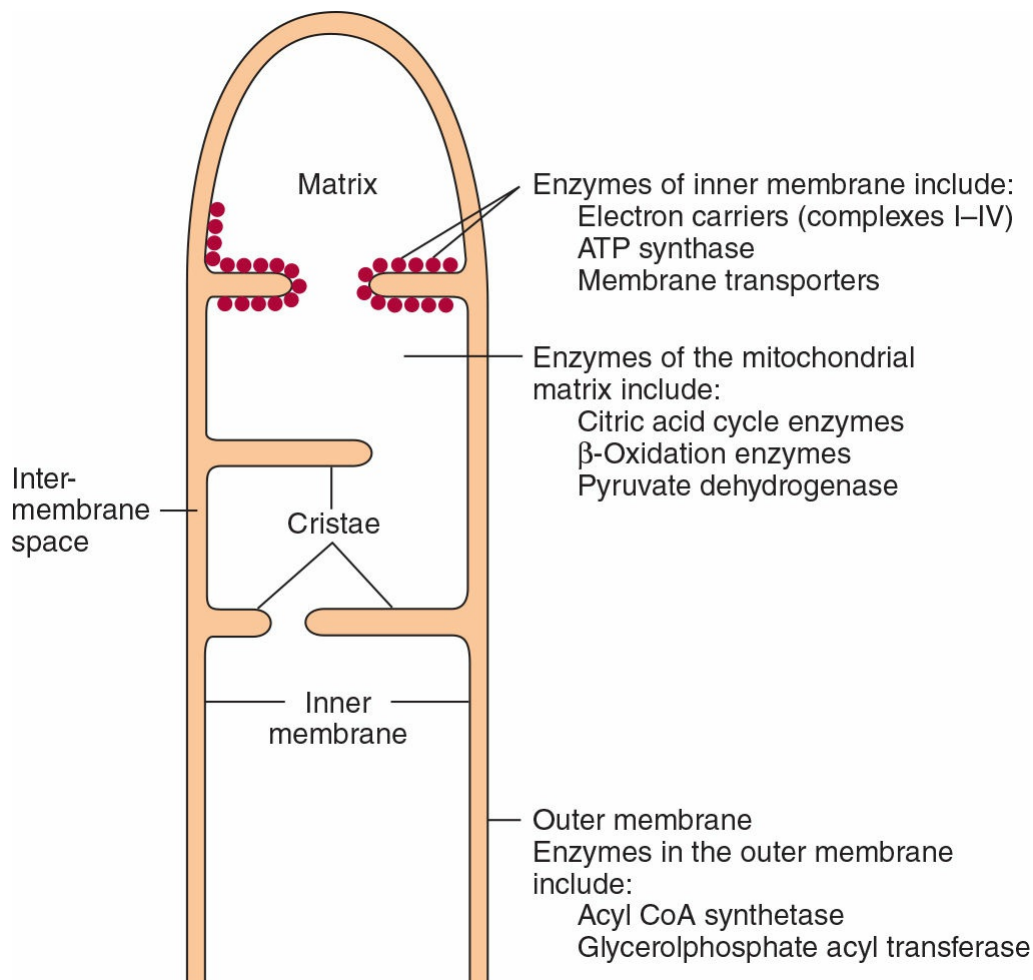

FIGURE 13–1 Structure of the mitochondrial membranes. Note that the inner membrane contains many folds or cristae.

THE RESPIRATORY CHAIN OXIDIZES REDUCING EQUIVALENTS & ACTS AS A

PROTON PUMP

Most of the energy liberated during the oxidation of carbohydrate, fatty acids, and amino acids is made available within mitochondria as reducing equivalents (—H or electrons) (**Figure 13–2**). The enzymes of the citric acid cycle and β -oxidation (see **Chapters 22** and **16**), **the respiratory chain complexes**, and the machinery for **oxidative phosphorylation** are all found in mitochondria. The respiratory chain collects and transports reducing equivalents, directing them to their final reaction with oxygen to form water, and oxidative phosphorylation is the process by which the liberated free energy is trapped as **high-energy phosphate**.

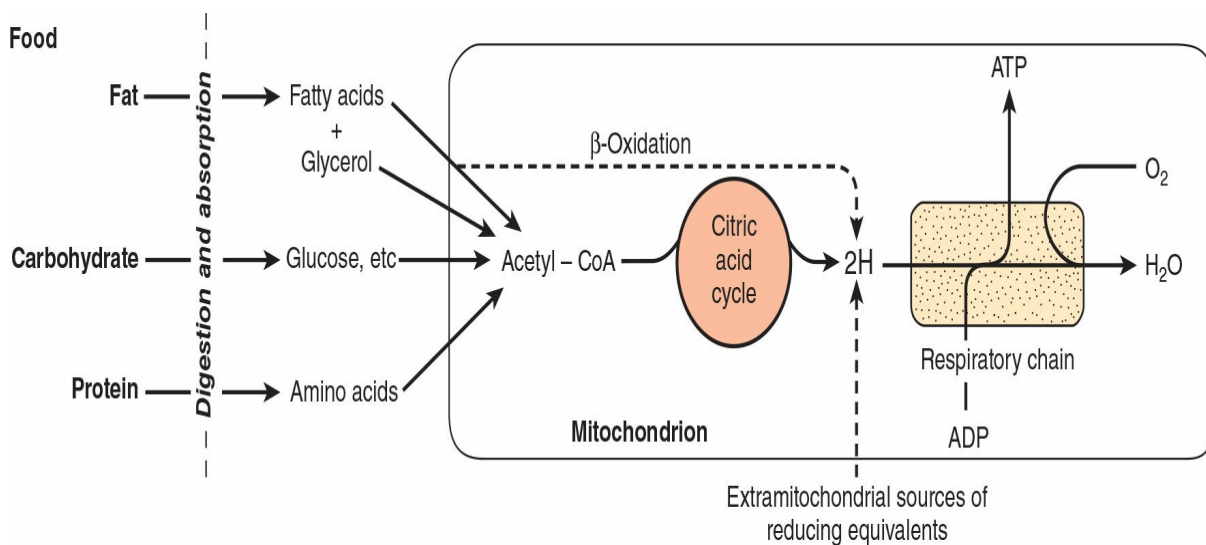

FIGURE 13–2 Role of the respiratory chain of mitochondria in the conversion of food energy to ATP. Oxidation of the major foodstuffs leads to the generation of reducing equivalents (2H) that are collected by the respiratory chain for oxidation and coupled generation of ATP.

Components of the Respiratory Chain Are Contained in Four Large Protein Complexes Embedded in the Inner Mitochondrial Membrane

Electrons flow through the respiratory chain through a redox span of 1.1 V from NAD^+/NADH to $\text{O}_2/2\text{H}_2\text{O}$ (see **Table 12–1**), passing through three large protein complexes: **NADH-Q oxidoreductase (Complex I)**, where electrons are transferred from NADH to **coenzyme Q (Q)** (also called **ubiquinone**); **Q-cytochrome c oxidoreductase (Complex III)**, which passes the electrons on to **cytochrome c**; and **cytochrome c oxidase**

(Complex IV), which completes the chain, passing the electrons to O_2 and causing it to be reduced to H_2O (**Figure 13–3**). Some substrates with more positive redox potentials than $NAD^+/NADH$ (eg, succinate) pass electrons to Q via a fourth complex, **succinate-Q reductase (Complex II)**, rather than Complex I. The four complexes are embedded in the inner mitochondrial membrane, but Q and cytochrome *c* are mobile. Q diffuses rapidly within the membrane, while cytochrome *c* is a soluble protein.

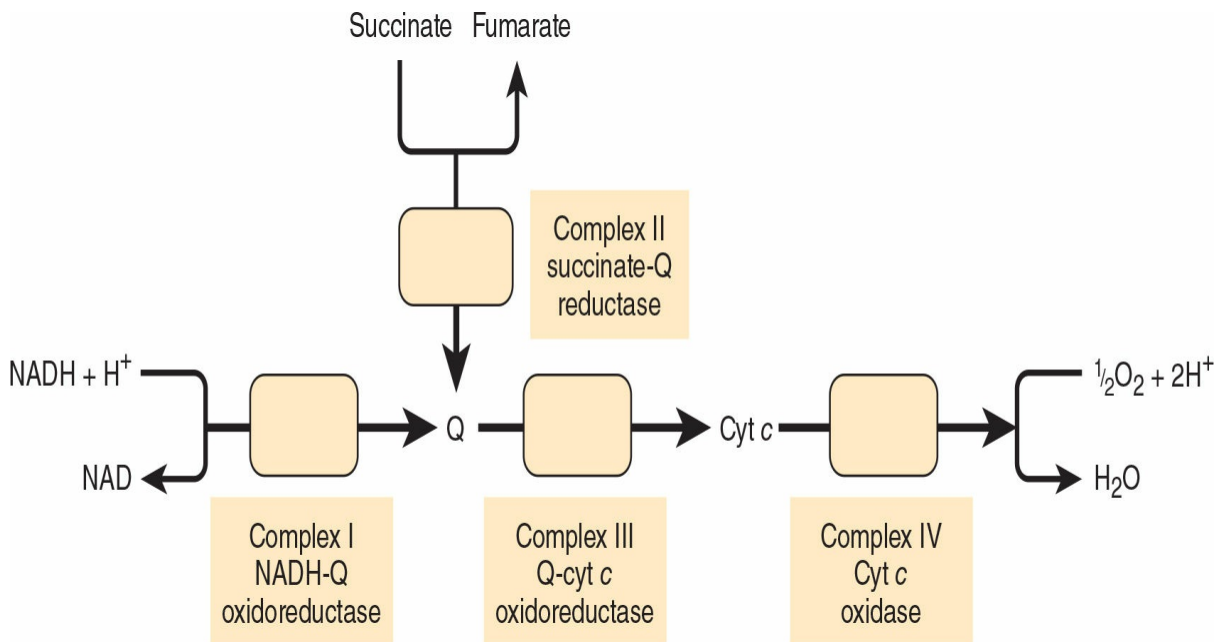

FIGURE 13–3 Overview of electron flow through the respiratory chain. (cyt, cytochrome; Q, coenzyme Q or ubiquinone.)

Flavoproteins & Iron-Sulfur Proteins (Fe-S) Are Components of the Respiratory Chain Complexes

Flavoproteins (see [Chapter 12](#)) are important components of Complexes I and II. The oxidized flavin nucleotide (flavin mononucleotide [FMN] or flavin adenine dinucleotide [FAD]) can be reduced in reactions involving the transfer of two electrons (to form $FMNH_2$ or $FADH_2$), but they can also accept one electron to form the semiquinone (see [Figure 12–2](#)). **Iron-sulfur proteins (nonheme iron proteins, Fe-S)** are found in Complexes I, II, and III. These may contain one, two, or four Fe atoms linked to inorganic sulfur atoms and/or via cysteine-SH groups to the protein ([Figure 13–4](#)). The Fe-S take part in single electron transfer reactions in which one Fe atom undergoes oxidoreduction between Fe^{2+} and Fe^{3+} .

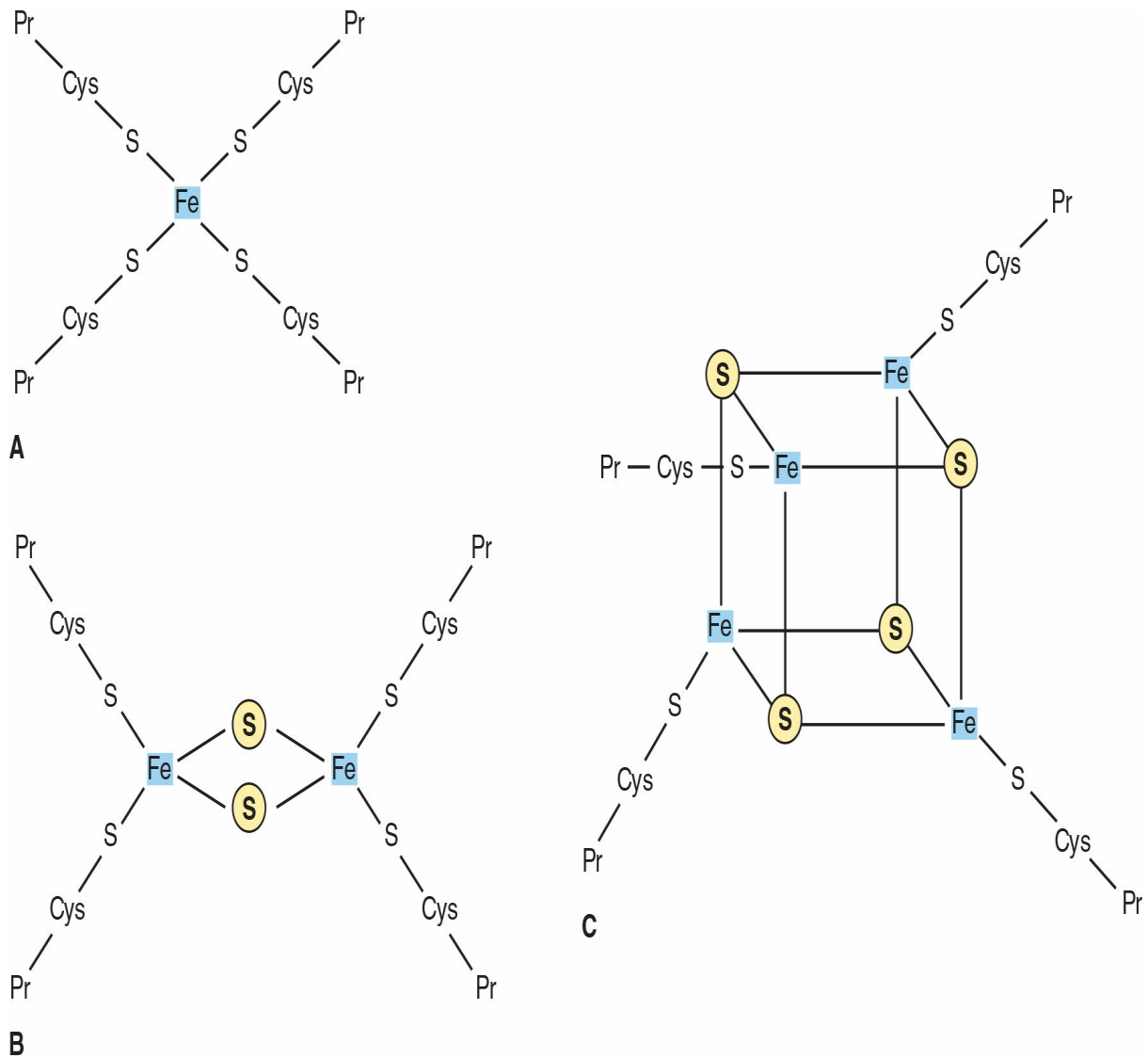
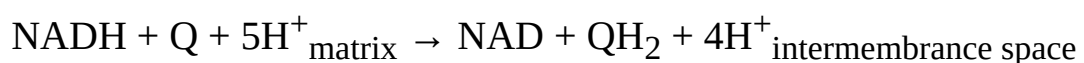

FIGURE 13–4 Iron-sulfur proteins (Fe-S). (A) The simplest Fe-S with one Fe bound by four cysteines. (B) 2Fe-2S center. (C) 4Fe-4S center. (Cys, cysteine; Pr, apoprotein; S, inorganic sulfur.)

Q Accepts Electrons via Complexes I & II

NADH-Q oxidoreductase or Complex I is a large L-shaped multisubunit protein that catalyzes electron transfer from NADH to Q, and during the process four H^+ are transferred across the membrane into the intermembrane space:



Electrons are transferred from NADH to FMN initially, then to a series of Fe-S centers, and finally to Q (**Figure 13–5**). In Complex II (succinate-Q

reductase), FADH_2 is formed during the conversion of succinate to fumarate in the citric acid cycle (see [Figure 16–3](#)) and electrons are then passed via several Fe-S centers to Q ([Figure 13–5](#)). Glycerol-3-phosphate (generated in the breakdown of triacylglycerols or from glycolysis, see [Figure 17–2](#)) and acyl-CoA also pass electrons to Q via different pathways involving flavoproteins ([Figure 13–5](#)).

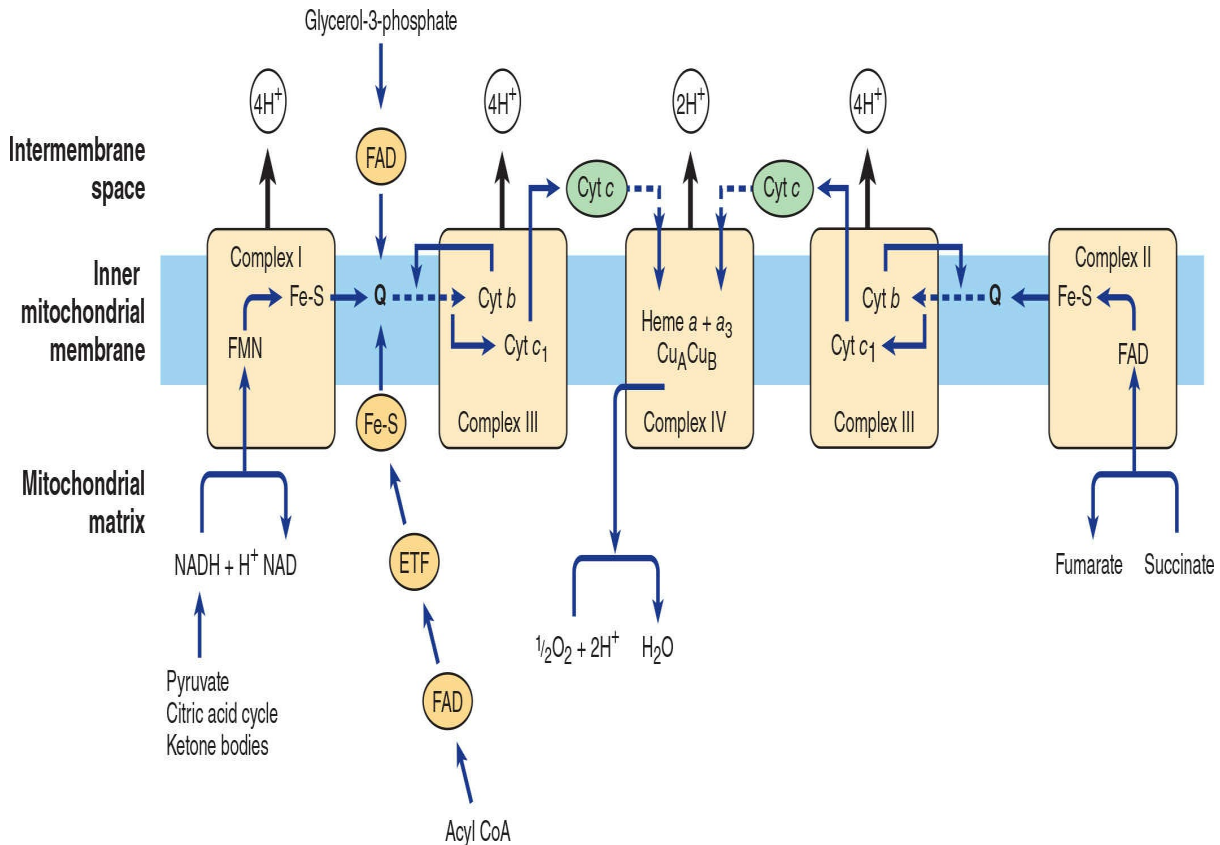
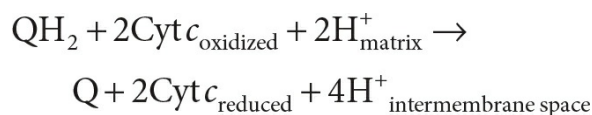

FIGURE 13–5 Flow of electrons through the respiratory chain complexes, showing the entry points for reducing equivalents from important substrates. Q and cyt c are mobile components of the system as indicated by the dotted arrows. The flow through Complex III (the Q cycle) is shown in more detail in [Figure 13–6](#). (cyt, cytochrome; ETF, electron transferring flavoprotein; Fe-S, iron-sulfur protein; Q, coenzyme Q or ubiquinone.)

The Q Cycle Couples Electron Transfer to Proton Transport in Complex III

Electrons are passed from QH_2 to cytochrome c via Complex III (Q-cytochrome c oxidoreductase):



The process is believed to involve **cytochromes** c_1 , b_L , and b_H and a **Rieske Fe-S** (an unusual Fe-S in which one of the Fe atoms is linked to two histidine residues rather than two cysteine residues) ([Figure 13–5](#)) and is known as the **Q cycle** ([Figure 13–6](#)). Q may exist in three forms: the oxidized quinone, the reduced quinol, or the semiquinone ([Figure 13–6](#)). The semiquinone is formed transiently during the cycle, one turn of which results in the oxidation of 2QH_2 to Q, releasing 4H^+ into the intermembrane space, and the reduction of one Q to QH_2 , causing 2H^+ to be taken up from the matrix ([Figure 13–6](#)). Note that while Q carries two electrons, the cytochromes carry only one, thus the oxidation of one QH_2 is coupled to the reduction of two molecules of cytochrome *c* via the Q cycle.

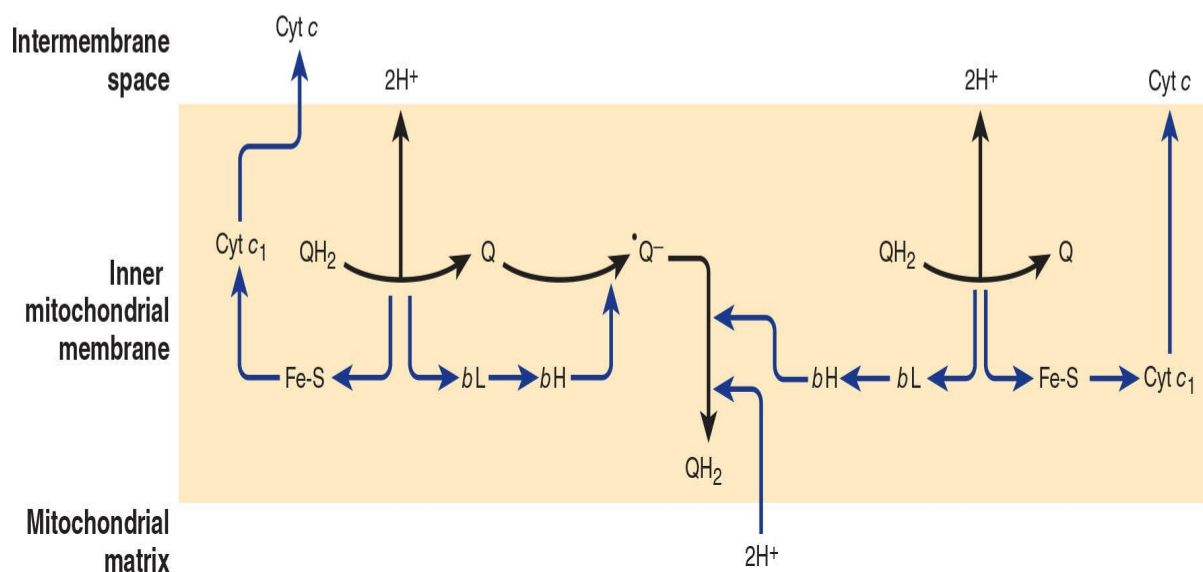
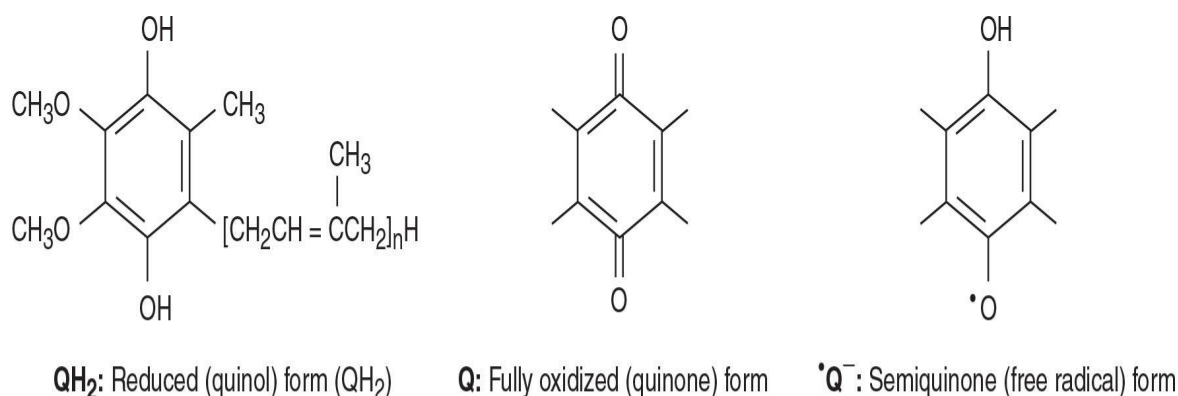
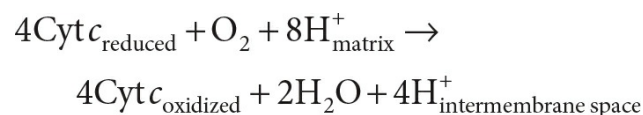

FIGURE 13–6 The Q cycle. During the oxidation of QH₂ to Q, one electron is donated to cyt *c* via a Rieske Fe-S and cyt *c*₁ and the second to a Q to form the semiquinone via cyt *b*_L and cyt *b*_H, with 2H⁺ being released into the intermembrane space. A similar process then occurs with a second QH₂, but in this case the second electron is donated to the semiquinone, reducing it to QH₂, and 2H⁺ are taken up from the matrix. (cyt, cytochrome; Fe-S, iron-sulfur protein; Q, coenzyme Q or ubiquinone.)

Molecular Oxygen Is Reduced to Water via Complex IV

Reduced cytochrome *c* is oxidized by Complex IV (cytochrome *c* oxidase), with the concomitant reduction of O₂ to two molecules of water:



Four electrons are transferred from cytochrome *c* to O₂ via **two heme groups, *a* and *a*₃, and Cu** (Figure 13–5). Electrons are passed initially to a Cu center (Cu_A), which contains 2Cu atoms linked to two protein cysteine-SH groups (resembling an Fe-S), then in sequence to heme *a*, heme *a*₃, a second Cu center, Cu_B, which is linked to heme *a*₃, and finally to O₂.

Eight H⁺ are removed from the matrix, of which four are used to form two water molecules and four are pumped into the intermembrane space. Thus, for every pair of electrons passing down the chain from NADH or FADH₂, 2H⁺ are pumped across the membrane by Complex IV. The O₂ remains tightly bound to Complex IV until it is fully reduced, and this minimizes the release of potentially damaging intermediates such as superoxide anions or peroxide which are formed when O₂ accepts one or two electrons, respectively (see Chapter 12).

ELECTRON TRANSPORT VIA THE RESPIRATORY CHAIN CREATES A PROTON GRADIENT WHICH DRIVES THE SYNTHESIS

OF ATP

The flow of electrons through the respiratory chain generates ATP by the process of **oxidative phosphorylation**. The **chemiosmotic theory**, proposed by Peter Mitchell in 1961, postulates that the two processes are coupled by a proton gradient across the inner mitochondrial membrane so that **the proton motive force** caused by the electrochemical potential difference (negative on the matrix side) drives the mechanism of ATP synthesis. As we have seen, Complexes I, III, and IV act as **proton pumps**, moving H^+ from the mitochondrial matrix to the intermembrane space. Since the inner mitochondrial membrane is impermeable to ions in general and particularly to protons, these accumulate in the intermembrane space, creating the proton motive force predicted by the chemiosmotic theory.

A Membrane-Located ATP Synthase Functions as a Rotary Motor to Form ATP

The proton motive force drives a membrane-located **ATP synthase** that forms ATP in the presence of $P_i + ADP$. ATP synthase is embedded in the inner membrane, together with the respiratory chain complexes (**Figure 13–7**). Several subunits of the protein form a ball-like shape arranged around an axis known as F_1 , which projects into the matrix and contains the phosphorylation mechanism (**Figure 13–8**). F_1 is attached to a membrane protein complex known as F_0 , which also consists of several protein subunits. F_0 spans the membrane and forms a proton channel. As protons flow through F_0 driven by the proton gradient across the membrane it rotates, driving the production of ATP in the F_1 complex (**Figures 13–7 and 13–8**). This is thought to occur by a **binding change mechanism** in which the conformation of the β subunits in F_1 is changed as the axis rotates from one that binds ATP tightly to one that releases ATP and binds ADP and P_i so that the next ATP can be formed. As indicated above, for each NADH oxidized, Complexes I and III translocate four protons each and Complex IV translocates two.

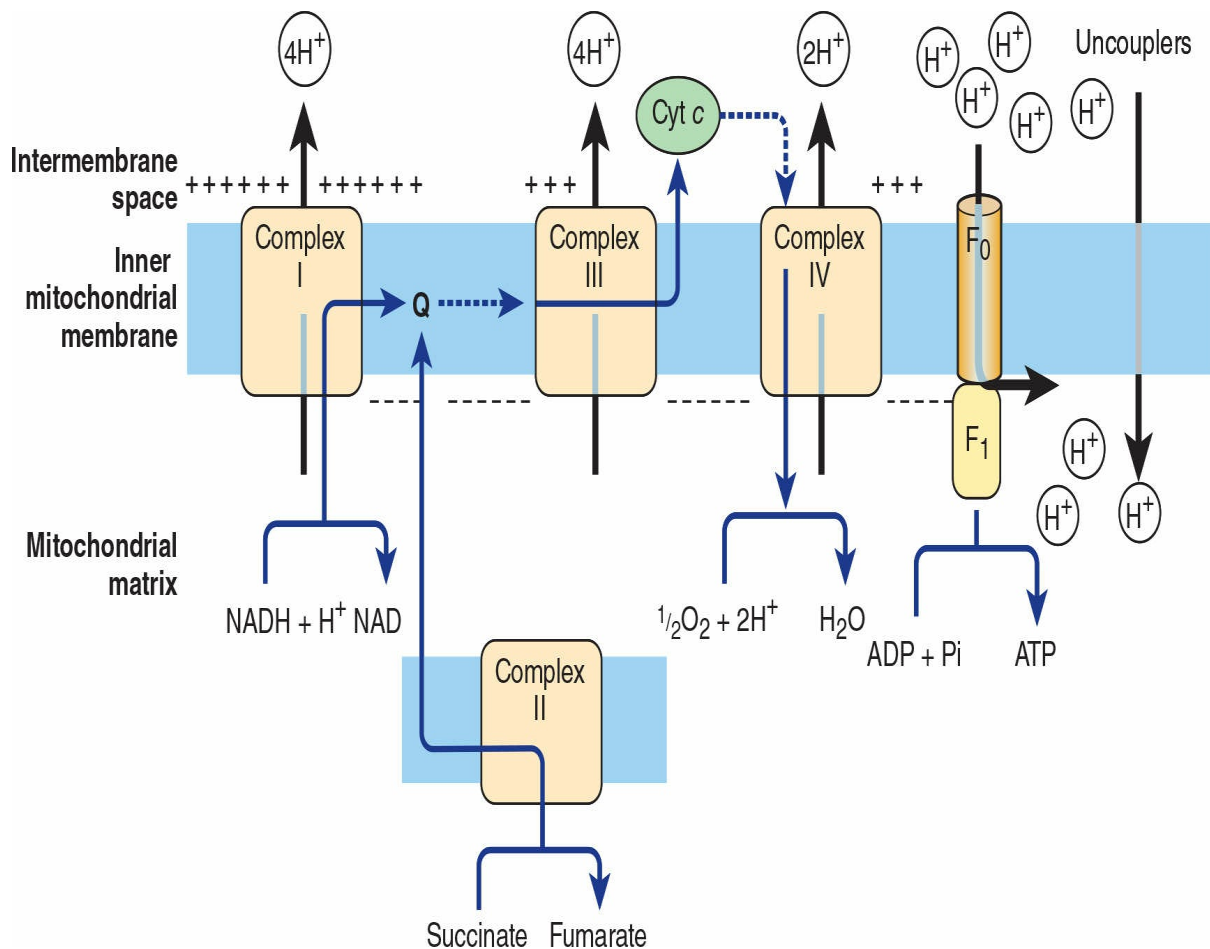

FIGURE 13–7 The chemiosmotic theory of oxidative phosphorylation. Complexes I, III, and IV act as proton pumps creating a proton gradient across the membrane, which is negative on the matrix side. The proton motive force generated drives the synthesis of ATP as the protons flow back into the matrix through the ATP synthase enzyme (Figure 13–8). Uncouplers increase the permeability of the membrane to ions, collapsing the proton gradient by allowing the H⁺ to pass across without going through the ATP synthase, and thus uncouple electron flow through the respiratory complexes from ATP synthesis. (cyt, cytochrome; Q, coenzyme Q or ubiquinone.)

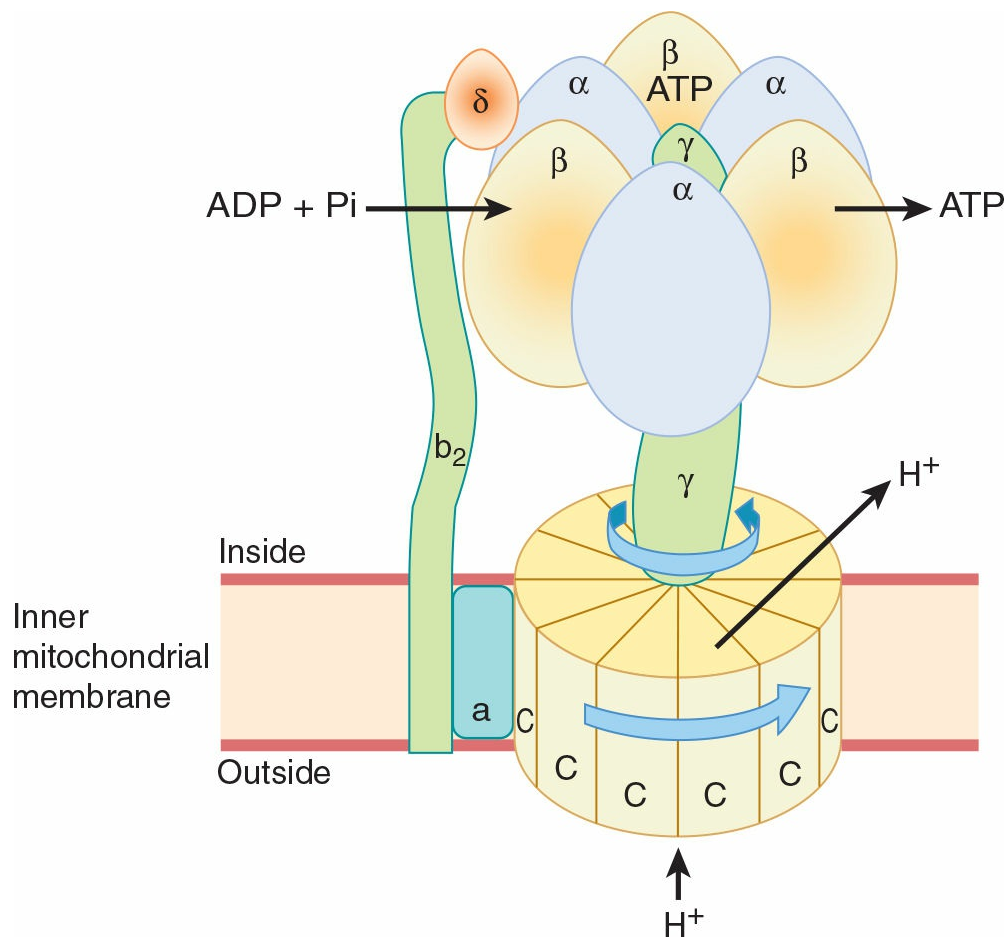

FIGURE 13–8 Mechanism of ATP production by ATP synthase. The enzyme complex consists of an F₀ subcomplex which is a disk of “C” protein subunits. Attached is a γ subunit in the form of a “bent axle.” Protons passing through the disk of “C” units cause it and the attached γ subunit to rotate. The γ subunit fits inside the F₁ subcomplex of three α and three β subunits, which are fixed to the membrane and do not rotate. ADP and P_i are taken up sequentially by the β subunits to form ATP, which is expelled as the rotating γ subunit squeezes each β subunit in turn and changes its conformation. Thus, three ATP molecules are generated per revolution. For clarity, not all the subunits that have been identified are shown—eg, the “axle” also contains an ε subunit.

THE RESPIRATORY CHAIN PROVIDES MOST OF THE ENERGY CAPTURED DURING CATABOLISM

ADP captures, in the form of high-energy phosphate, a significant proportion of the free energy released by catabolic processes. The resulting

ATP has been called the **energy “currency”** of the cell because it passes on this free energy to drive those processes requiring energy (see [Figure 11–5](#)).

There is a net direct capture of two high-energy phosphate groups in the glycolytic reactions (see [Table 17–1](#)). Two more high-energy phosphates per mole of glucose are captured in the citric acid cycle during the conversion of succinyl-CoA to succinate (see [Chapter 16](#)). All of these phosphorylations occur at the **substrate level**. For each mol of substrate oxidized via Complexes I, III, and IV in the respiratory chain (ie, via NADH), 2.5 mol of ATP are formed per 0.5 mol of O₂ consumed, that is, the P:O ratio = 2.5 ([Figure 13–7](#)). On the other hand, when 1 mol of substrate (eg, succinate or 3-phosphoglycerate) is oxidized via Complexes II, III, and IV, only 1.5 mol of ATP are formed, that is, P:O = 1.5. These reactions are known as **oxidative phosphorylation at the respiratory chain level**. Taking these values into account, it can be estimated that nearly 90% of the high-energy phosphates produced from the complete oxidation of 1 mol glucose is obtained via oxidative phosphorylation coupled to the respiratory chain (see [Table 17–1](#)).

Respiratory Control Ensures a Constant Supply of ATP

The rate of respiration of mitochondria can be controlled by the availability of ADP. This is because oxidation and phosphorylation are **tightly coupled**; that is, oxidation cannot proceed via the respiratory chain without concomitant phosphorylation of ADP. [Table 13–1](#) shows the five conditions controlling the rate of respiration in mitochondria. Most cells in the resting state are in **state 4**, and respiration is controlled by the availability of ADP. When work is performed, ATP is converted to ADP, allowing more respiration to occur, which in turn replenishes the store of ATP. Under certain conditions, the concentration of inorganic phosphate can also affect the rate of functioning of the respiratory chain. As respiration increases (as in exercise), the cell approaches **state 3 or 5** when either the capacity of the respiratory chain becomes saturated or the PO₂ decreases below the K_m for heme a_3 . There is also the possibility that the ADP/ATP transporter, which facilitates entry of cytosolic ADP into and ATP out of the mitochondrion, becomes rate limiting.

TABLE 13–1 States of Respiratory Control

Conditions Limiting the Rate of Respiration	
State 1	Availability of ADP and substrate
State 2	Availability of substrate only
State 3	The capacity of the respiratory chain itself, when all substrates and components are present in saturating amounts
State 4	Availability of ADP only
State 5	Availability of oxygen only

Thus, the manner in which biologic oxidative processes allow the free energy resulting from the oxidation of foodstuffs to become available and to be captured is stepwise, efficient, and controlled—rather than explosive, inefficient, and uncontrolled, as in many nonbiologic processes. The remaining free energy that is not captured as high-energy phosphate is liberated as **heat**. This need not be considered “wasted” since it ensures that the respiratory system as a whole is sufficiently exergonic to be removed from equilibrium, allowing continuous unidirectional flow and constant provision of ATP. It also contributes to maintenance of body temperature.

MANY POISONS INHIBIT THE RESPIRATORY CHAIN

Much information about the respiratory chain has been obtained by the use of inhibitors, and, conversely, this has provided knowledge about the mechanism of action of several poisons (**Figure 13–9**). They may be classified as inhibitors of the respiratory chain, inhibitors of oxidative phosphorylation, or uncouplers of oxidative phosphorylation.

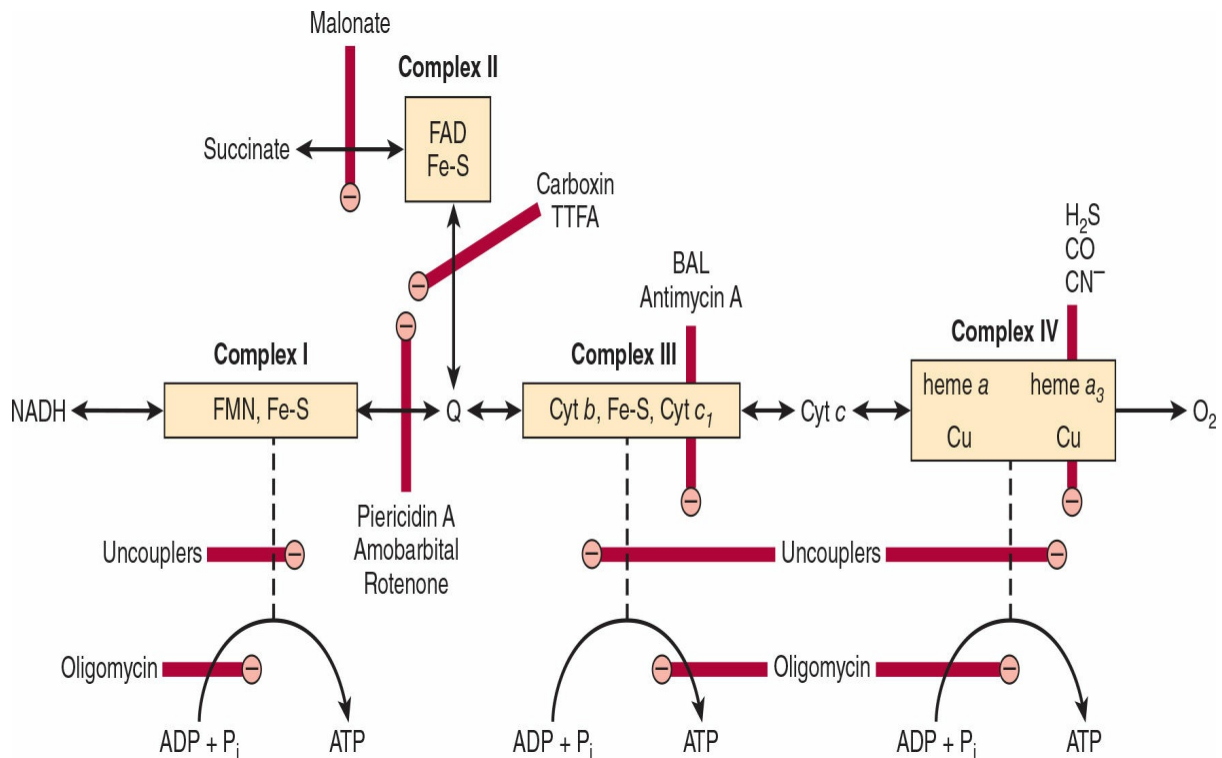

FIGURE 13–9 Sites of inhibition (⊖) of the respiratory chain by specific drugs, chemicals, and antibiotics. (BAL, dimercaprol; TTFA, an Fe-chelating agent. Other abbreviations as in Figure 13–5.)

Barbiturates such as amobarbital inhibit electron transport via Complex I by blocking the transfer from Fe-S to Q. At sufficient dosage, they are fatal. **Antimycin A** and **dimercaprol** inhibit the respiratory chain at Complex III. The classic poisons **H₂S**, **carbon monoxide**, and **cyanide** inhibit Complex IV and can therefore totally arrest respiration. **Malonate** is a competitive inhibitor of Complex II.

Attractyloside inhibits oxidative phosphorylation by inhibiting the transporter of ADP into and ATP out of the mitochondrion (Figure 13–10). The antibiotic **oligomycin** completely blocks oxidation and phosphorylation by blocking the flow of protons through ATP synthase (Figure 13–9).

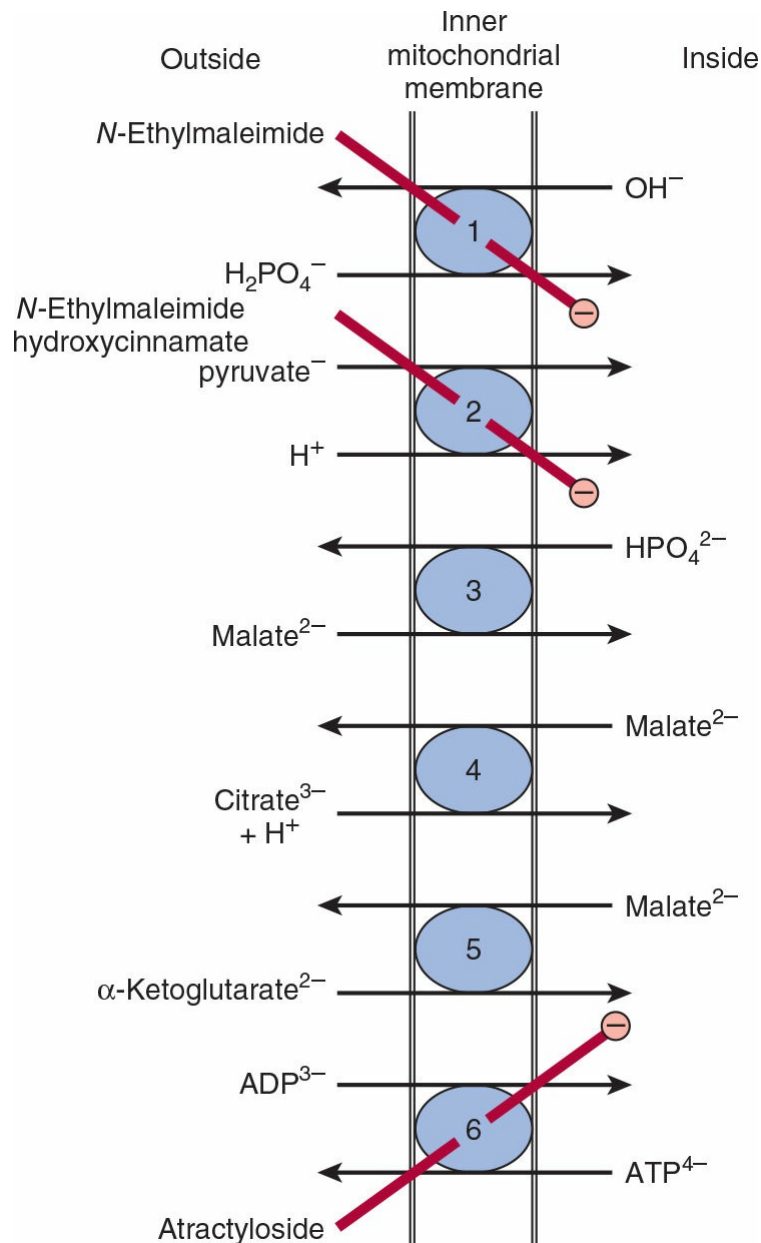

FIGURE 13–10 Transporter systems in the inner mitochondrial membrane. ① Phosphate transporter, ② pyruvate symport, ③ dicarboxylate transporter, ④ tricarboxylate transporter, ⑤ α -ketoglutarate transporter, ⑥ adenine nucleotide transporter. *N*-Ethylmaleimide, hydroxycinnamate, and atractyloside inhibit (⊖) the indicated systems. Also present (but not shown) are transporter systems for glutamate/aspartate (Figure 13–13), glutamine, ornithine, neutral amino acids, and carnitine (see Figure 22–1).

Uncouplers dissociate oxidation in the respiratory chain from phosphorylation (Figure 13–7). These compounds are toxic, causing respiration to become uncontrolled, since the rate is no longer limited by

the concentration of ADP or P_i . The uncoupler that has been used most frequently is **2,4-dinitrophenol**, but other compounds act in a similar manner. **Thermogenin (or the uncoupling protein)** is a physiologic uncoupler found in brown adipose tissue that functions to generate body heat, particularly for the newborn and during hibernation in animals (see [Chapter 25](#)).

THE CHEMIOSMOTIC THEORY CAN ACCOUNT FOR RESPIRATORY CONTROL AND THE ACTION OF UNCOUPLERS

The electrochemical potential difference across the membrane, once established as a result of proton translocation, inhibits further transport of reducing equivalents through the respiratory chain unless discharged by back-translocation of protons across the membrane through the ATP synthase. This in turn depends on availability of ADP and P_i .

Uncouplers (eg, dinitrophenol) are amphipathic (see [Chapter 21](#)) and increase the permeability of the lipid inner mitochondrial membrane to protons, thus reducing the electrochemical potential and short-circuiting the ATP synthase ([Figure 13–7](#)). In this way, oxidation can proceed without phosphorylation.

THE SELECTIVE PERMEABILITY OF THE INNER MITOCHONDRIAL MEMBRANE NECESSITATES EXCHANGE TRANSPORTERS

Exchange diffusion systems involving transporter proteins that span the membrane are present in the membrane for exchange of anions against OH^- ions and cations against H^+ ions. Such systems are necessary for uptake and output of ionized metabolites while preserving electrical and osmotic equilibrium. The inner mitochondrial membrane is freely permeable to **uncharged small molecules**, such as oxygen, water, CO_2 , NH_3 , and to **monocarboxylic acids**, such as 3-hydroxybutyric, acetoacetic, and acetic, especially in their undissociated, more lipid soluble form. **Long-chain fatty acids** are transported into mitochondria via the carnitine system (see [Figure 22–1](#)), and there is also a special carrier for **pyruvate** involving a symport that utilizes the H^+ gradient from outside to inside the mitochondrion ([Figure 13–10](#)). However, **dicarboxylate and**

tricarboxylate anions (eg, malate, citrate) and amino acids require specific transporter or carrier systems to facilitate their passage across the membrane.

The transport of di- and tricarboxylate anions is closely linked to that of inorganic phosphate, which penetrates readily as the H_2PO_4^- ion in exchange for OH^- . The net uptake of malate by the dicarboxylate transporter requires inorganic phosphate for exchange in the opposite direction. The net uptake of citrate, isocitrate, or *cis*-aconitate by the tricarboxylate transporter requires malate in exchange. α -Ketoglutarate transport also requires an exchange with malate. The adenine nucleotide transporter allows the exchange of ATP and ADP, but not AMP. It is vital for ATP exit from mitochondria to the sites of extramitochondrial utilization and for the return of ADP for ATP production within the mitochondrion (**Figure 13–11**). Since in this translocation four negative charges are removed from the matrix for every three taken in, the electrochemical gradient across the membrane (the proton motive force) favors the export of ATP. Na^+ can be exchanged for H^+ , driven by the proton gradient. It is believed that active uptake of Ca^{2+} by mitochondria occurs with a net charge transfer of 1 (Ca^+ uniport), possibly through a $\text{Ca}^{2+}/\text{H}^+$ antiport. Calcium release from mitochondria is facilitated by exchange with Na^+ .

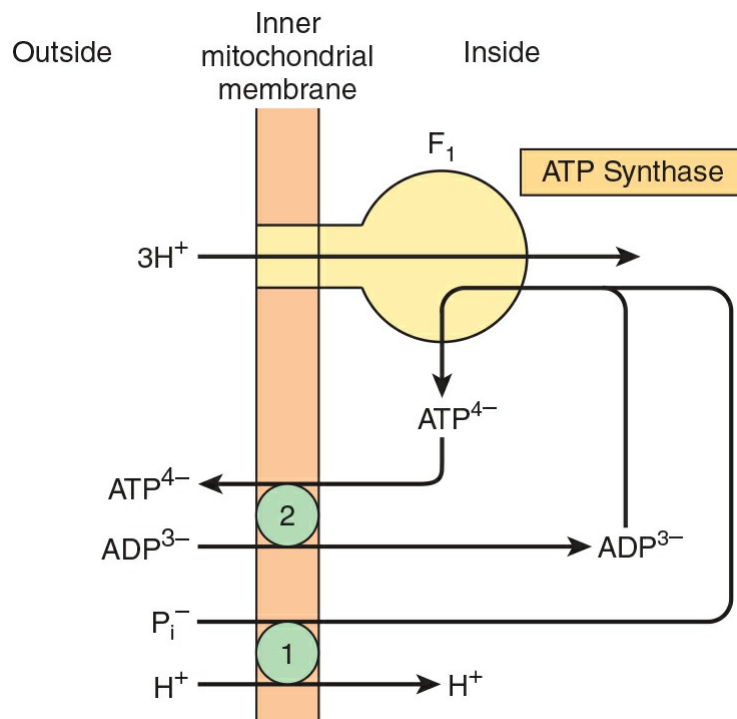

FIGURE 13–11 Combination of phosphate transporter ① with the adenine nucleotide transporter ② in ATP synthesis. The H^+/P_i symport shown is equivalent to the P_i/OH^- antiport shown in Figure 13–10.

Ionophores Permit Specific Cations to Penetrate Membranes

Ionophores are lipophilic molecules that complex specific cations and facilitate their transport through biologic membranes, for example, **valinomycin** (K^+). The classic uncouplers such as dinitrophenol are, in fact, proton ionophores.

A Proton-Translocating Transhydrogenase Is a Source of Intramitochondrial NADPH

Energy-linked transhydrogenase, a protein in the inner mitochondrial membrane, couples the passage of protons down the electrochemical gradient from outside to inside the mitochondrion with the transfer of H from intramitochondrial NADH to NADPH for intramitochondrial enzymes such as glutamate dehydrogenase and hydroxylases involved in steroid synthesis.

Oxidation of Extramitochondrial NADH Is Mediated by Substrate Shuttles

NADH cannot penetrate the mitochondrial membrane, but it is produced continuously in the cytosol by 3-phosphoglyceraldehyde dehydrogenase, an enzyme in the glycolysis sequence (see Figure 17–2). However, under aerobic conditions, extramitochondrial NADH does not accumulate and is presumed to be oxidized by the respiratory chain in mitochondria. The transfer of reducing equivalents through the mitochondrial membrane requires **substrate pairs**, linked by suitable dehydrogenases on each side of the mitochondrial membrane. The mechanism of transfer using the **glycerophosphate shuttle** is shown in Figure 13–12. Since the mitochondrial enzyme is linked to the respiratory chain via a flavoprotein rather than NAD, only 1.5 mol rather than 2.5 mol of ATP are formed per atom of oxygen consumed. Although this shuttle is present in some tissues (eg, brain, white muscle), in others (eg, heart muscle) it is deficient. It is therefore believed that the **malate shuttle** system (Figure 13–13) is of

more universal utility. The complexity of this system is due to the impermeability of the mitochondrial membrane to oxaloacetate, which must react with glutamate to form aspartate and α -ketoglutarate by transamination before transport through the mitochondrial membrane and reconstitution to oxaloacetate in the cytosol.

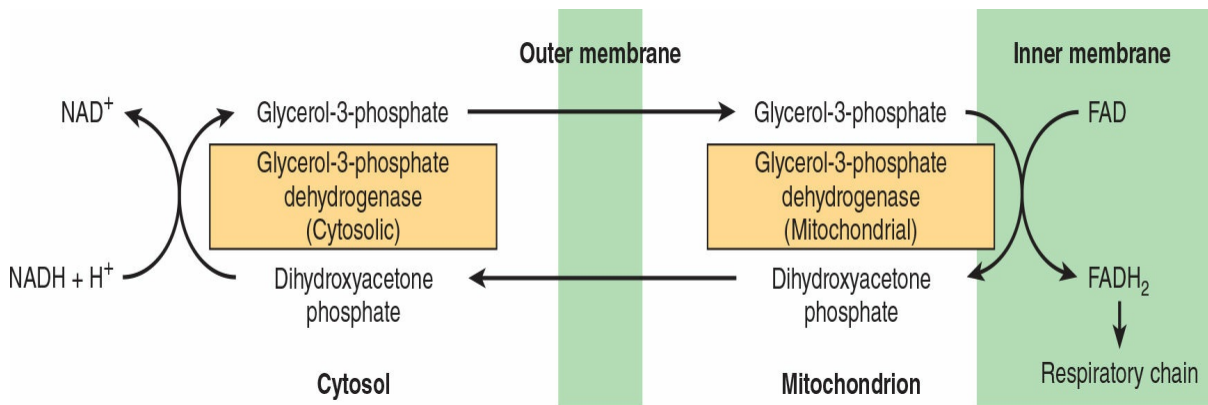

FIGURE 13–12 Glycerophosphate shuttle for transfer of reducing equivalents from the cytosol into the mitochondrion.

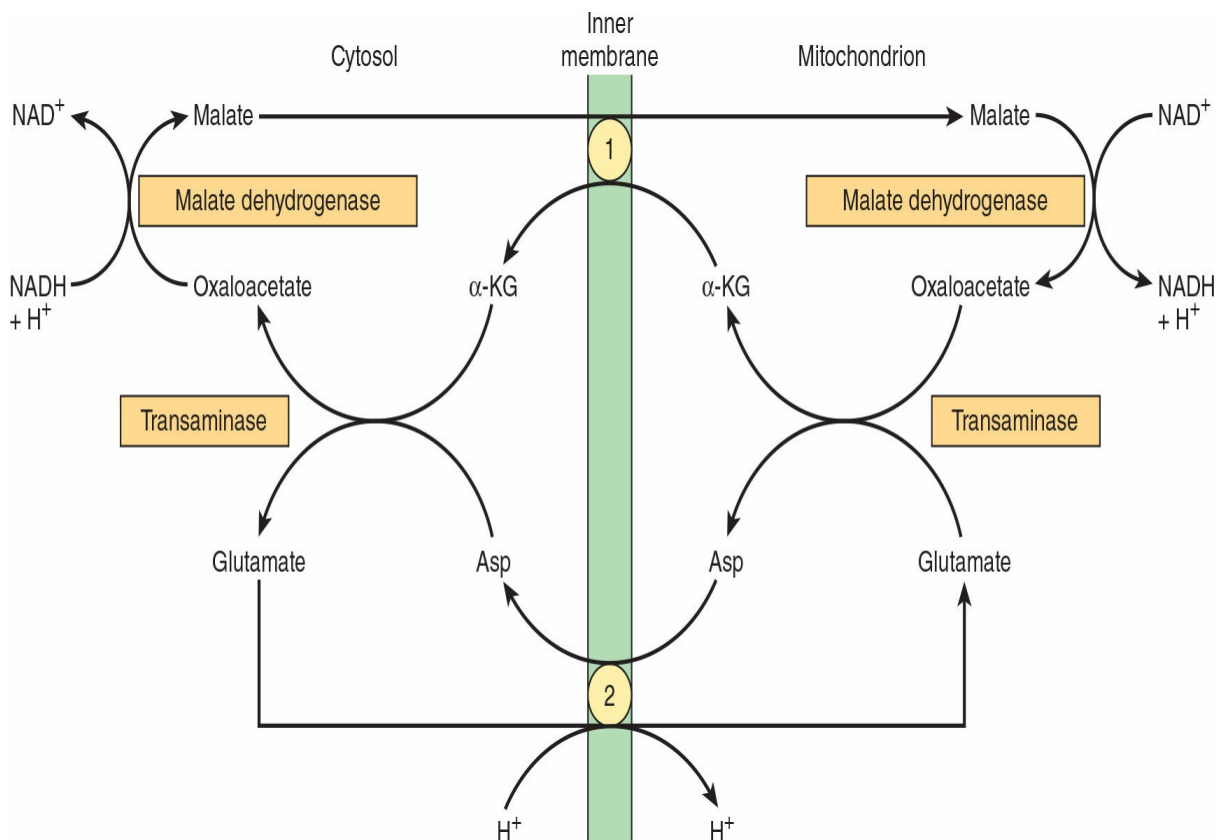

FIGURE 13–13 Malate shuttle for transfer of reducing equivalents from the cytosol into the mitochondrion. ① α -Ketoglutarate transporter and ② glutamate/aspartate transporter (note the proton symport with

glutamate).

Ion Transport in Mitochondria Is Energy Linked

Mitochondria maintain or accumulate cations such as K^+ , Na^+ , Ca^{2+} , Mg^{2+} , and P_i . It is assumed that a primary proton pump drives cation exchange.

The Creatine Phosphate Shuttle Facilitates Transport of High-Energy Phosphate From Mitochondria

The **creatine phosphate shuttle** ([Figure 13–14](#)) augments the functions of **creatine phosphate** as an energy buffer by acting as a dynamic system for transfer of high-energy phosphate from mitochondria in active tissues such as heart and skeletal muscle. An isoenzyme of **creatine kinase** (CK_m) is found in the mitochondrial intermembrane space, catalyzing the transfer of high-energy phosphate to creatine from ATP emerging from the adenine nucleotide transporter. In turn, the creatine phosphate is transported into the cytosol via protein pores in the outer mitochondrial membrane, becoming available for generation of extramitochondrial ATP.

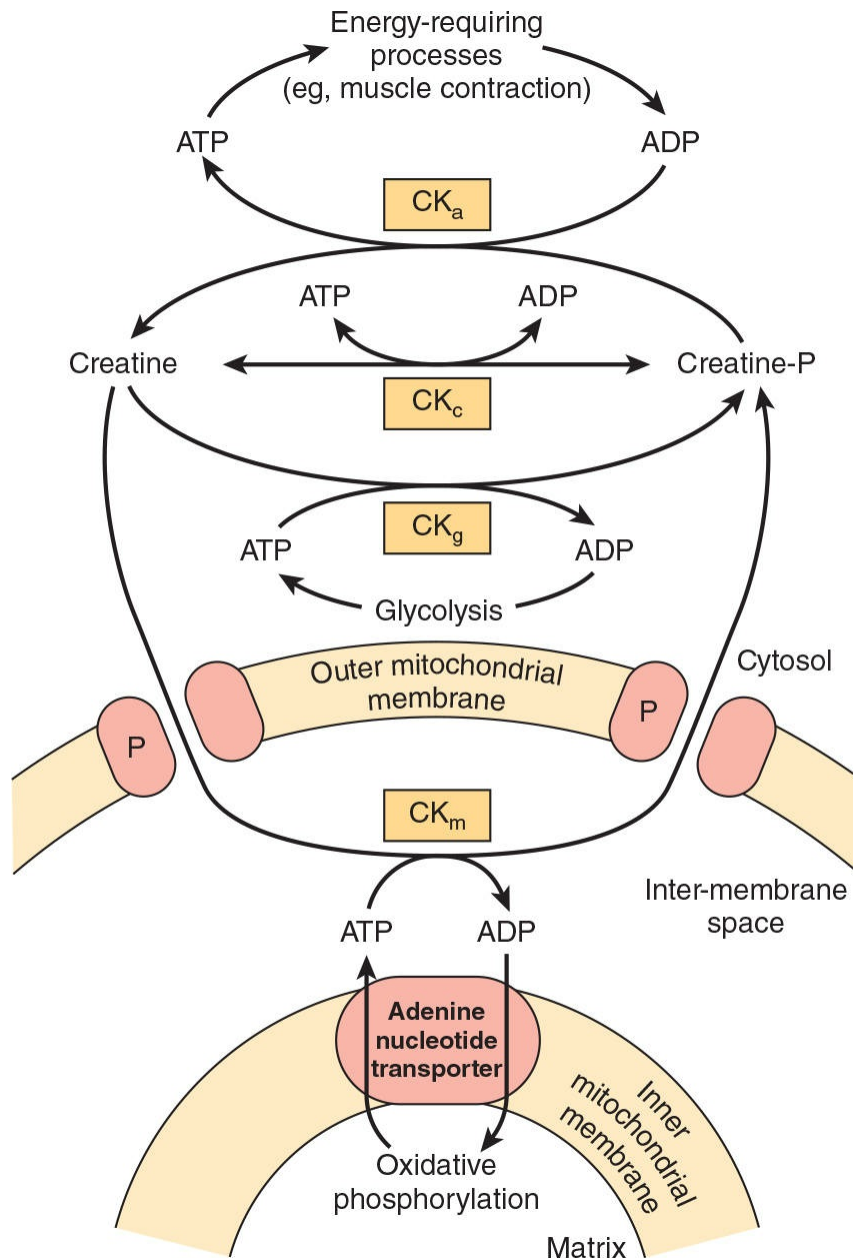

FIGURE 13–14 The creatine phosphate shuttle of heart and skeletal muscle. The shuttle allows rapid transport of high-energy phosphate from the mitochondrial matrix into the cytosol. (CK_a , creatine kinase concerned with large requirements for ATP, eg, muscular contraction; CK_c , creatine kinase for maintaining equilibrium between creatine and creatine phosphate and ATP/ADP; CK_g , creatine kinase coupling glycolysis to creatine phosphate synthesis; CK_m , mitochondrial creatine kinase mediating creatine phosphate production from ATP formed in oxidative phosphorylation; P, pore protein in outer mitochondrial membrane.)

CLINICAL ASPECTS

The condition known as **fatal infantile mitochondrial myopathy and renal dysfunction** involves severe diminution or absence of most oxidoreductases of the respiratory chain. **MELAS** (mitochondrial encephalopathy, lactic acidosis, and stroke) is an inherited condition due to NADH-Q oxidoreductase (Complex I) or cytochrome oxidase (Complex IV) deficiency. It is caused by a mutation in mitochondrial DNA and may be involved in **Alzheimer disease** and **diabetes mellitus**. A number of drugs and poisons act by inhibition of oxidative phosphorylation (see above).

SUMMARY

- Virtually all energy released from the oxidation of carbohydrate, fat, and protein is made available in mitochondria as reducing equivalents (—H or e^-). These are funneled into the respiratory chain, where they are passed down a redox gradient of carriers to their final reaction with oxygen to form water.
- The redox carriers are grouped into four respiratory chain complexes in the inner mitochondrial membrane. Three of the four complexes are able to use the energy released in the redox gradient to pump protons to the outside of the membrane, creating an electrochemical potential between the matrix and the inner membrane space.
- ATP synthase spans the membrane and acts like a rotary motor using the potential energy of the proton gradient or proton motive force to synthesize ATP from ADP and P_i . In this way, oxidation is closely coupled to phosphorylation to meet the energy needs of the cell.
- Since the inner mitochondrial membrane is impermeable to protons and other ions, special exchange transporters span the membrane to allow ions such as OH^- , ATP^{4-} , ADP^{3-} , and metabolites to pass through without discharging the electrochemical gradient across the membrane.
- Many well-known poisons such as cyanide arrest respiration by inhibition of the respiratory chain.

REFERENCES

- Kocherginsky N: Acidic lipids, H^+ -ATPases, and mechanism of oxidative phosphorylation. Physico-chemical ideas 30 years after P. Mitchell's Nobel Prize award. Prog Biophys Mol Biol 2009;99:20.
- Mitchell P: Keilin's respiratory chain concept and its chemiosmotic

consequences. *Science* 1979;206:1148.
Nakamoto RK, Baylis Scanlon JA, Al-Shawi MK: The rotary mechanism of the ATP synthase. *Arch Biochem Biophys* 2008;476:43.

Exam Questions

Section III – Bioenergetics

1. Which one of the following statements about the free energy change (ΔG) in a biochemical reaction is CORRECT?
 - A. If ΔG is negative, the reaction proceeds spontaneously with a loss of free energy.
 - B. In an exergonic reaction, ΔG is positive.
 - C. The standard free energy change when reactants are present in concentrations of 1.0 mol/L and the pH is 7.0 is represented as ΔG^0 .
 - D. In an endergonic reaction there is a loss of free energy.
 - E. If a reaction is essentially irreversible, it has a high positive ΔG .
2. If the ΔG of a reaction is zero:
 - A. The reaction goes virtually to completion and is essentially irreversible.
 - B. The reaction is endergonic.
 - C. The reaction is exergonic.
 - D. The reaction proceeds only if free energy can be gained.
 - E. The system is at equilibrium and no net change occurs.
3. $\Delta G^{0'}$ is defined as the standard free energy charge when:
 - A. The reactants are present in concentrations of 1.0 mol/L.
 - B. The reactants are present in concentrations of 1.0 mol/L at pH 7.0.
 - C. The reactants are present in concentrations of 1.0 mmol/L at pH 7.0.

- D. The reactants are present in concentrations of 1.0 $\mu\text{mol/L}$.
- E. The reactants are present in concentrations of 1.0 mol/L at pH 7.4.
4. Which of the following statements about ATP is CORRECT?
- A. It contains three high-energy phosphate bonds.
- B. It is needed in the body to drive exergonic reactions.
- C. It is used as an energy store in the body.
- D. It functions in the body as a complex with Mg^{2+} .
- E. It is synthesized by ATP synthase in the presence of uncouplers such as UCP-1 (thermogenin).
5. Which one of the following enzymes uses molecular oxygen as a hydrogen acceptor?
- A. Cytochrome *c* oxidase
- B. Isocitrate dehydrogenase
- C. Homogentisate dioxygenase
- D. Catalase
- E. Superoxide dismutase
6. Which one of the following statement about cytochromes is INCORRECT?
- A. They are hemoproteins that take part in oxidation–reduction reactions.
- B. They contain iron which oscillates between Fe^{3+} and Fe^{2+} during the reactions they participate in.
- C. They act as electron carriers in the respiratory chain in mitochondria.
- D. They have an important role in the hydroxylation of steroids in the endoplasmic reticulum.
- E. They are all dehydrogenase enzymes.
7. Which one of the following statement about cytochromes P450 is INCORRECT?
- A. They are able to accept electrons from either NADH or NADPH.
- B. They are found only in the endoplasmic reticulum.
- C. They are monooxygenase enzymes.
- D. They play a major role in drug detoxification in the liver.

- E. In some reactions they work in conjunction with cytochrome *b5*.
8. As one molecule of NADH is oxidized via the respiratory chain:
- A. 1.5 molecules of ATP are produced in total.
 - B. 1 molecule of ATP is produced as electrons pass through complex IV.
 - C. 1 molecule of ATP is produced as electrons pass through complex II.
 - D. 1 molecule of ATP is produced as electrons pass through complex III.
 - E. 0.5 of a molecule of ATP is produced as electrons pass through complex I.
9. The number of ATP molecules produced for each molecule of FADH₂ oxidized via the respiratory chain is:
- A. 1
 - B. 2.5
 - C. 1.5
 - D. 2
 - E. 0.5
10. A number of compounds inhibit oxidative phosphorylation—the synthesis of ATP from ADP and inorganic phosphate linked to oxidation of substrates in mitochondria. Which of the following describes the action of oligomycin?
- A. It discharges the proton gradient across the mitochondrial inner membrane.
 - B. It discharges the proton gradient across the mitochondrial outer membrane.
 - C. It inhibits the electron transport chain directly by binding to one of the electron carriers in the mitochondrial inner membrane.
 - D. It inhibits the transport of ADP into, and ATP out of, the mitochondrial matrix.
 - E. It inhibits the transport of protons back into the mitochondrial matrix through ATP synthase.
11. A number of compounds inhibit oxidative phosphorylation—the synthesis of ATP from ADP and inorganic phosphate linked to

oxidation of substrates in mitochondria. Which of the following describes the action of an uncoupler?

- A. It discharges the proton gradient across the mitochondrial inner membrane.
 - B. It discharges the proton gradient across the mitochondrial outer membrane.
 - C. It inhibits the electron transport chain directly by binding to one of the electron carriers in the mitochondrial inner membrane.
 - D. It inhibits the transport of ADP into, and ATP out of, the mitochondrial matrix.
 - E. It inhibits the transport of protons back into the mitochondrial matrix through the stalk of the primary particle.
12. A student takes some tablets she is offered at a disco, and without asking what they are she swallows them. A short time later she starts to hyperventilate, and becomes very hot. What is the most likely action of the tablets she has taken?
- A. An inhibitor of mitochondrial ATP synthesis
 - B. An inhibitor of mitochondrial electron transport
 - C. An inhibitor of the transport of ADP into mitochondria to be phosphorylated
 - D. An inhibitor of the transport of ATP out of mitochondria into the cytosol
 - E. An uncoupler of mitochondrial electron transport and oxidative phosphorylation
13. The flow of electrons through the respiratory chain and the production of ATP are normally tightly coupled. The processes are uncoupled by which of the following?
- A. Cyanide
 - B. Oligomycin
 - C. Thermogenin
 - D. Carbon monoxide
 - E. Hydrogen sulphide
14. Which of the following statements about ATP synthase is INCORRECT?
- A. It is located in the inner mitochondrial membrane.

- B. It requires a proton motive force to form ATP in the presence of ADP and Pi.
 - C. ATP is produced when part of the molecule rotates.
 - D. One ATP molecule is formed for each full revolution of the molecule.
 - E. The F_1 subcomplex is fixed to the membrane and does not rotate.
15. The chemiosmotic theory of Peter Mitchell proposes a mechanism for the tight coupling of electron transport via the respiratory chain to the process of oxidative phosphorylation. Which of the following options is NOT predicted by the theory?
- A. A proton gradient across the inner mitochondrial membrane generated by electron transport drives ATP synthesis.
 - B. The electrochemical potential difference across the inner mitochondrial membrane caused by electron transport is positive on the matrix side.
 - C. Protons are pumped across the inner mitochondrial membrane as electrons pass down the respiratory chain.
 - D. An increase in the permeability of the inner mitochondrial membrane to protons uncouples the processes of electron transport and oxidative phosphorylation.
 - E. ATP synthesis occurs when the electrochemical potential difference across the membrane is discharged by translocation of protons back across the inner mitochondrial membrane through an ATP synthase enzyme.

SECTION

IV

Metabolism of Carbohydrates

CHAPTER

14

Overview of Metabolism & the Provision of Metabolic Fuels

David A. Bender, PhD & Peter A. Mayes, PhD, DSc

OBJECTIVES

After studying this chapter, you should be able to:

- Explain what is meant by anabolic, catabolic, and amphibolic metabolic pathways.
- Describe in outline the metabolism of carbohydrates, lipids, and amino acids at the level of tissues and organs, and at the subcellular level, and the interconversion of metabolic fuels.
- Describe the ways in which flux of metabolites through metabolic pathways is regulated.

- Describe how a supply of metabolic fuels is provided in the fed and fasting states; the formation of metabolic fuels reserves in the fed state and their mobilization in fasting.

BIOMEDICAL IMPORTANCE

Metabolism is the term used to describe the interconversion of chemical compounds in the body, the pathways taken by individual molecules, their interrelationships, and the mechanisms that regulate the flow of metabolites through the pathways. Metabolic pathways fall into three categories. (1) **Anabolic pathways** are involved in the synthesis of larger and more complex compounds from smaller precursors—for example, the synthesis of protein from amino acids and the synthesis of reserves of triacylglycerol and glycogen. Anabolic pathways are endothermic. (2) **Catabolic pathways** are involved in the breakdown of larger molecules, commonly involving oxidative reactions; they are exothermic, producing reducing equivalents, and, mainly via the respiratory chain (see [Chapter 13](#)), ATP. (3) **Amphibolic pathways** occur at the “crossroads” of metabolism, acting as links between anabolic and catabolic pathways, for example, the citric acid cycle (see [Chapter 16](#)).

Knowledge of normal metabolism is essential for an understanding of abnormalities that underlie disease. Normal metabolism includes adaptation to periods of fasting, starvation, and exercise, as well as pregnancy and lactation. Abnormal metabolism may result from nutritional deficiency, enzyme deficiency, abnormal secretion of hormones, or the actions of drugs and toxins.

A 70-kg adult human being requires about 8 to 12 MJ (1920-2900 kcal) from metabolic fuels each day, depending on physical activity. Larger animals require less per kilogram body weight, and smaller animals more. Growing children and animals have a proportionally higher requirement to allow for the energy cost of growth. For human beings, this energy requirement is met from carbohydrates (40-60%), lipids (mainly triacylglycerol, 30-40%), and protein (10-15%), as well as alcohol. The mix of carbohydrate, lipid, and protein being oxidized varies, depending on whether the subject is in the fed or fasting state, and on the duration and intensity of physical work.

There is a constant requirement for metabolic fuels throughout the day; average physical activity increases metabolic rate by about 40 to 50% over the basal or resting metabolic rate. However, most people consume their

daily intake of metabolic fuels in two or three meals, so there is a need to form reserves of carbohydrate (glycogen in liver and muscle), lipid (triacylglycerol in adipose tissue), and labile protein stores during the period following a meal, for use during the intervening time when there is no intake of food.

If the intake of metabolic fuels is consistently greater than energy expenditure, the surplus is stored, largely as triacylglycerol in adipose tissue, leading to the development of **obesity** and its associated health hazards. By contrast, if the intake of metabolic fuels is consistently lower than energy expenditure, there are negligible reserves of fat and carbohydrate, and amino acids arising from protein turnover are used for energy-yielding metabolism rather than replacement protein synthesis, leading to **emaciation**, wasting, and, eventually, death (see [Chapter 43](#)).

In the fed state, after a meal, there is an ample supply of carbohydrate, and the metabolic fuel for most tissues is glucose. In the fasting state, glucose must be spared for use by the central nervous system (which is largely dependent on glucose) and the red blood cells (which are wholly reliant on glucose). Therefore, tissues that can use fuels other than glucose do so; muscle and liver oxidize fatty acids and the liver synthesizes ketone bodies from fatty acids to export to muscle and other tissues. As glycogen reserves become depleted, amino acids arising from protein turnover are used for **gluconeogenesis** (see [Chapter 19](#)).

The formation and utilization of reserves of triacylglycerol and glycogen, and the extent to which tissues take up and oxidize glucose, are largely controlled by the hormones **insulin** and **glucagon**. In **diabetes mellitus**, there is either impaired synthesis and secretion of insulin (type I diabetes, sometimes called juvenile onset, or insulin-dependent diabetes) or impaired sensitivity of tissues to insulin action (type II diabetes, sometimes called adult-onset or noninsulin-dependent diabetes), leading to severe metabolic derangement. In cattle, the demands of heavy lactation can lead to ketosis, as can the demands of twin pregnancy in sheep.

PATHWAYS THAT PROCESS THE MAJOR PRODUCTS OF DIGESTION

The nature of the diet sets the basic pattern of metabolism. There is a need to process the products of digestion of dietary carbohydrate, lipid, and protein. These are mainly glucose, fatty acids and glycerol, and amino acids, respectively. In ruminants (and, to a lesser extent, other herbivores), dietary cellulose is fermented by symbiotic microorganisms to short-chain

fatty acids (acetic, propionic, butyric), and metabolism in these animals is adapted to use these fatty acids as major substrates. All the products of digestion are metabolized to a **common product, acetyl-CoA**, which is then oxidized by the **citric acid cycle** (see [Chapter 16](#)) (**Figure 14–1**).

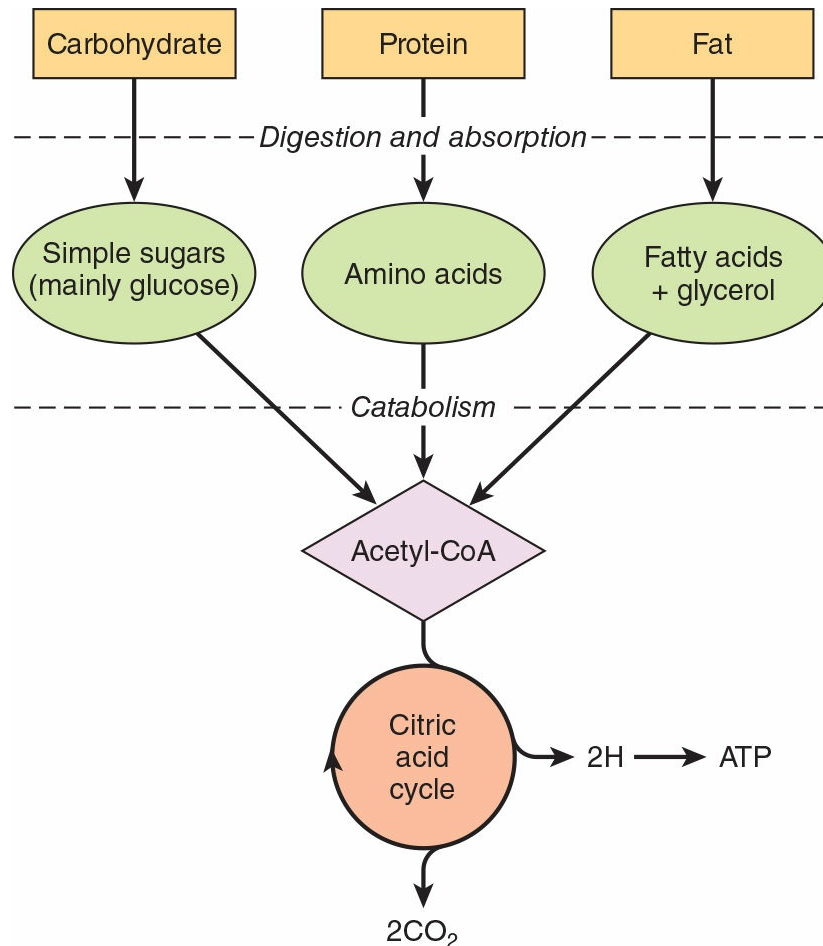

FIGURE 14–1 Outline of the pathways for the catabolism of carbohydrate, protein, and fat. All these pathways lead to the production of acetyl-CoA, which is oxidized in the citric acid cycle, ultimately yielding ATP by the process of oxidative phosphorylation.

Carbohydrate Metabolism Is Centered on the Provision & Fate of Glucose

Glucose is the major fuel of most tissues ([Figure 14–2](#)). It is metabolized to pyruvate by the pathway of **glycolysis** (see [Chapter 17](#)). Aerobic tissues metabolize pyruvate to **acetyl-CoA**, which can enter the citric acid cycle for complete oxidation to CO₂ and H₂O, linked to the formation of ATP in the process of **oxidative phosphorylation** (see [Figure 13–2](#)). Glycolysis can also occur anaerobically (in the absence of oxygen) when the end

product is lactate.

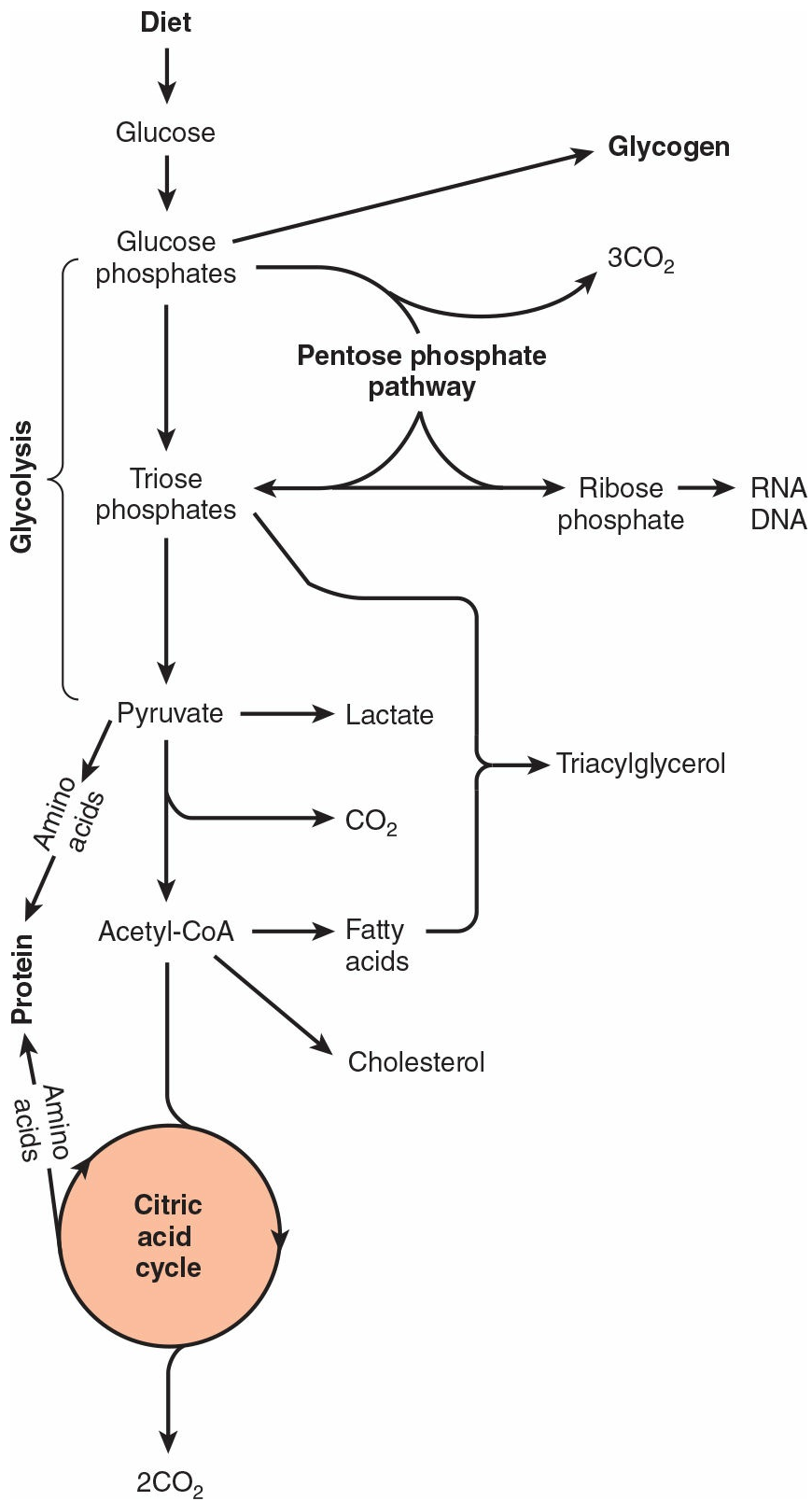

FIGURE 14–2 Overview of carbohydrate metabolism showing the major pathways and end products. Gluconeogenesis is not shown.

Glucose and its metabolites also take part in other processes, for example, the synthesis of the storage polymer **glycogen** in skeletal muscle and liver (see [Chapter 18](#)) and the **pentose phosphate pathway**, an alternative to part of the pathway of glycolysis (see [Chapter 20](#)). It is a source of reducing equivalents (NADPH) for fatty acid synthesis (see [Chapter 23](#)) and the source of **ribose** for nucleotide and nucleic acid synthesis (see [Chapter 33](#)). Triose phosphate intermediates in glycolysis give rise to the **glycerol moiety** of triacylglycerols. Pyruvate and intermediates of the citric acid cycle provide the carbon skeletons for the synthesis of nonessential or dispensable **amino acids** (see [Chapter 27](#)), and acetyl-CoA is the precursor of **fatty acids** (see [Chapter 23](#)) and **cholesterol** (see [Chapter 26](#)) and hence of all the steroid hormones synthesized in the body. **Gluconeogenesis** (see [Chapter 19](#)) is the process of synthesizing glucose from noncarbohydrate precursors such as lactate, amino acids, and glycerol.

Lipid Metabolism Is Concerned Mainly With Fatty Acids & Cholesterol

The source of long-chain fatty acids is either dietary lipid or de novo synthesis from acetyl-CoA derived from carbohydrate or amino acids. Fatty acids may be oxidized to **acetyl-CoA (β -oxidation)** or esterified with glycerol, forming **triacylglycerol** as the body's main fuel reserve.

Acetyl-CoA formed by β -oxidation of fatty acids may undergo three fates ([Figure 14-3](#)):

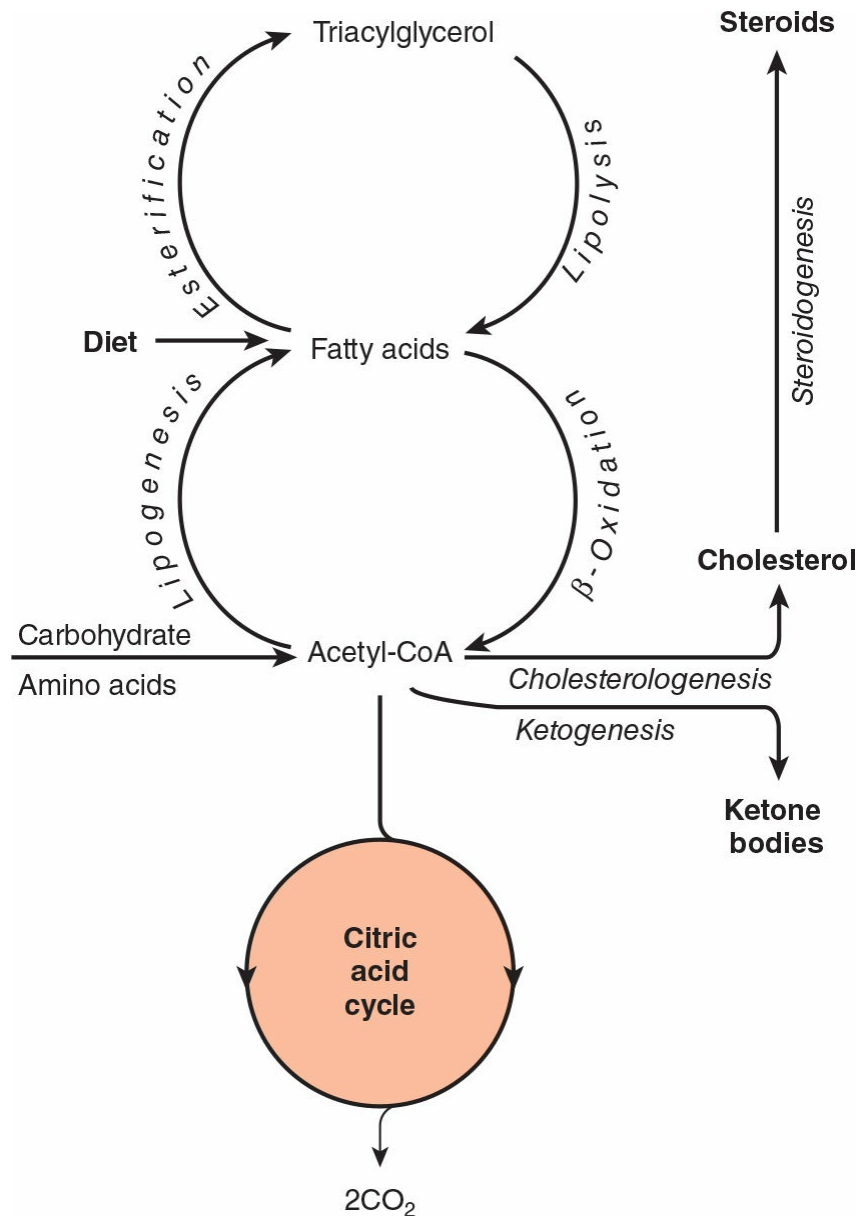

FIGURE 14–3 Overview of fatty acid metabolism showing the major pathways and end products. The ketone bodies are acetoacetate, 3-hydroxybutyrate, and acetone (which is formed nonenzymically by decarboxylation of acetoacetate).

1. As with acetyl-CoA arising from glycolysis, it is **oxidized** to $\text{CO}_2 + \text{H}_2\text{O}$ via the citric acid cycle.
2. It is the precursor for synthesis of **cholesterol** and other **steroids**.
3. In the liver, it is used to form the **ketone bodies**, acetoacetate, and 3-hydroxybutyrate (see [Chapter 22](#)), which are important fuels in prolonged fasting and starvation.

Much of Amino Acid Metabolism Involves Transamination

The amino acids are required for protein synthesis (**Figure 14–4**). Some must be supplied in the diet (the **essential or indispensable amino acids**), since they cannot be synthesized in the body. The remainder are **nonessential or dispensable amino acids**, which are supplied in the diet, but can also be formed from metabolic intermediates by **transamination** using the amino group from other amino acids (see **Chapter 27**). After **deamination**, amino nitrogen is excreted as **urea**, and the carbon skeletons that remain after transamination may (1) be oxidized to CO_2 via the citric acid cycle, (2) be used to synthesize glucose (gluconeogenesis, see **Chapter 19**), or (3) form ketone bodies or acetyl-CoA, which may be oxidized or used for synthesis of fatty acids (see **Chapter 28**).

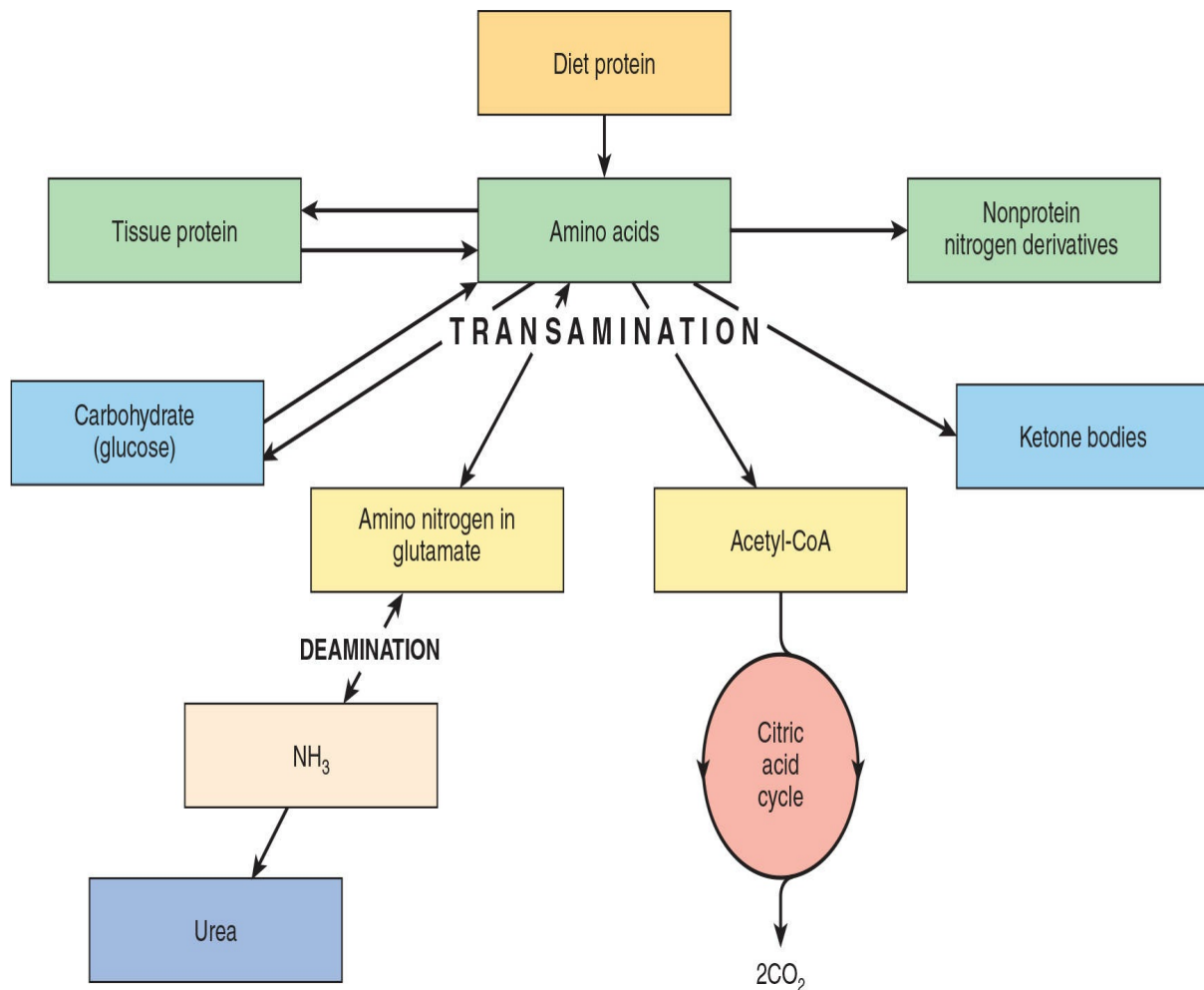

FIGURE 14–4 Overview of amino acid metabolism showing the major pathways and end products.

Several amino acids are also the precursors of other compounds, for example, purines, pyrimidines, hormones such as epinephrine and thyroxine, and neurotransmitters.

METABOLIC PATHWAYS MAY BE STUDIED AT DIFFERENT LEVELS OF ORGANIZATION

In addition to studies in the whole organism, the location and integration of metabolic pathways is revealed by studies at two levels of organization. At the **tissue and organ level**, the nature of the substrates entering and metabolites leaving tissues and organs can be measured. At the **subcellular level**, each cell organelle (eg, the mitochondrion) or compartment (eg, the cytosol) has specific roles that form part of a subcellular pattern of metabolic pathways.

At the Tissue & Organ Level, the Blood Circulation Integrates Metabolism

Amino acids resulting from the digestion of dietary protein and **glucose** resulting from the digestion of carbohydrates are absorbed via the hepatic portal vein. The liver has the role of regulating the blood concentration of these water-soluble metabolites (**Figure 14–5**). In the case of glucose, this is achieved by taking up glucose in excess of immediate requirements and using it to synthesize glycogen (**glycogenesis**, **Chapter 18**) or fatty acids (**lipogenesis**, **Chapter 23**). Between meals, the liver acts to maintain the blood glucose concentration by breaking down glycogen (**glycogenolysis**, **Chapter 18**) and, together with the kidney, by converting noncarbohydrate metabolites such as lactate, glycerol, and amino acids to glucose (**gluconeogenesis**, **Chapter 19**). The maintenance of an adequate blood concentration of glucose is essential for those tissues for which it is either the major fuel (the brain) or the only fuel (erythrocytes). The liver also **synthesizes the major plasma proteins** (eg, albumin) and **deaminates amino acids** that are in excess of requirements, synthesizing urea, which is transported to the kidney and excreted (see **Chapter 28**).

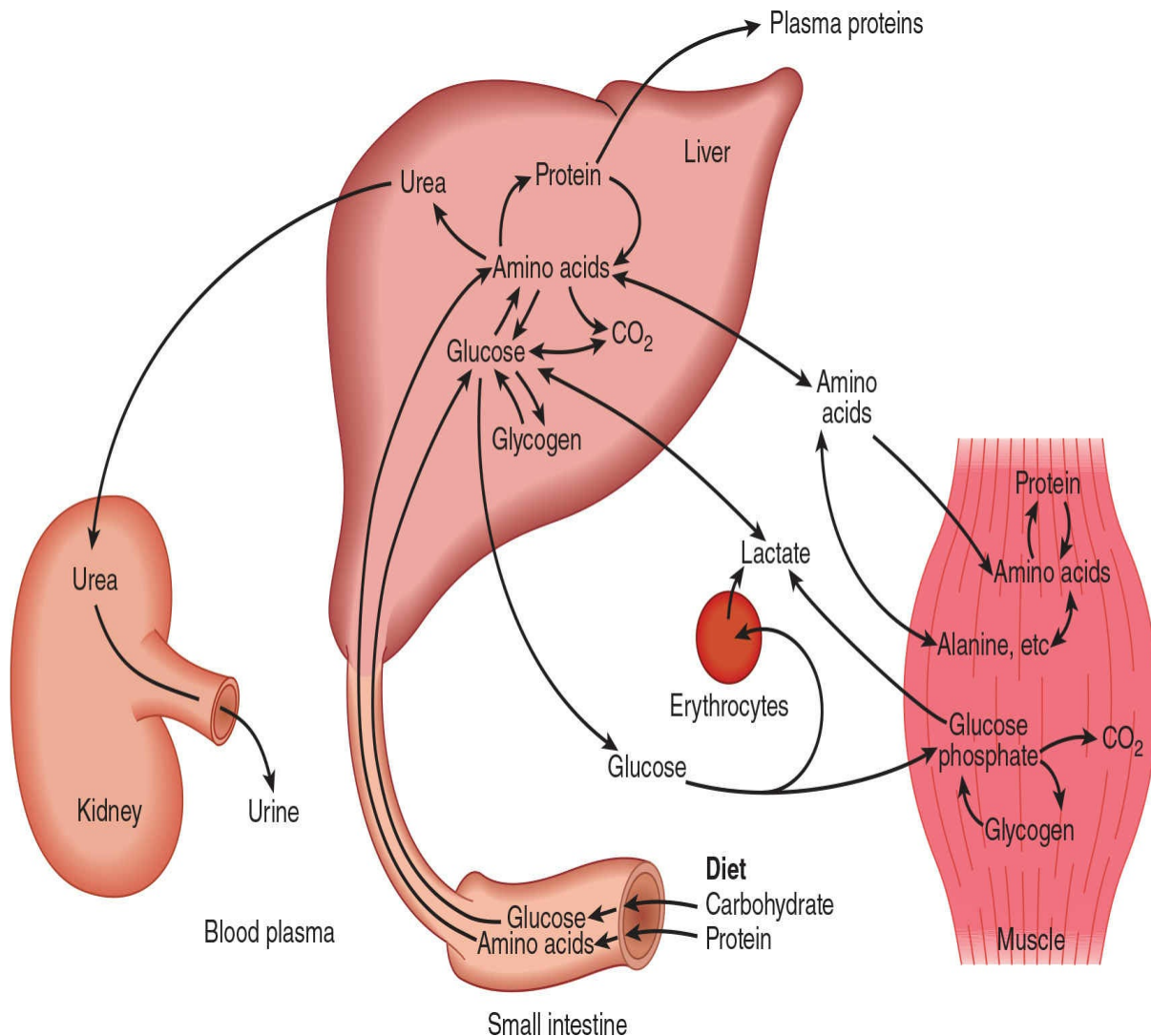

FIGURE 14–5 Transport and fate of major carbohydrate and amino acid substrates and metabolites. Note that there is little free glucose in muscle, since it is rapidly phosphorylated following uptake.

Skeletal muscle utilizes glucose as a fuel, both aerobically, forming CO_2 , and anaerobically, forming lactate. It stores glycogen as a fuel for use in muscle contraction and synthesizes muscle protein from plasma amino acids. Muscle accounts for approximately 50% of body mass and consequently represents a considerable store of protein that can be drawn upon to supply amino acids for gluconeogenesis in starvation (see [Chapter 19](#)).

The main dietary **lipids** ([Figure 14–6](#)) are triacylglycerols that are hydrolyzed to monoacylglycerols and fatty acids in the gut, then reesterified in the intestinal mucosa. Here they are packaged with protein and secreted into the lymphatic system and thence into the bloodstream as **chylomicrons**, the largest of the plasma **lipoproteins** (see [Chapter 25](#)).

Chylomicrons also contain other lipid-soluble nutrients, including vitamins A, D, E, and K (see [Chapter 44](#)). Unlike glucose and amino acids absorbed from the small intestine, chylomicron triacylglycerol is not taken up directly by the liver. It is first metabolized by tissues that have **lipoprotein lipase**, which hydrolyzes the triacylglycerol, releasing fatty acids that are incorporated into tissue lipids or oxidized as fuel. The chylomicron remnants are cleared by the liver. The other major source of long-chain fatty acids is synthesis (**lipogenesis**) from carbohydrate, in adipose tissue and the liver (see [Chapter 23](#)).

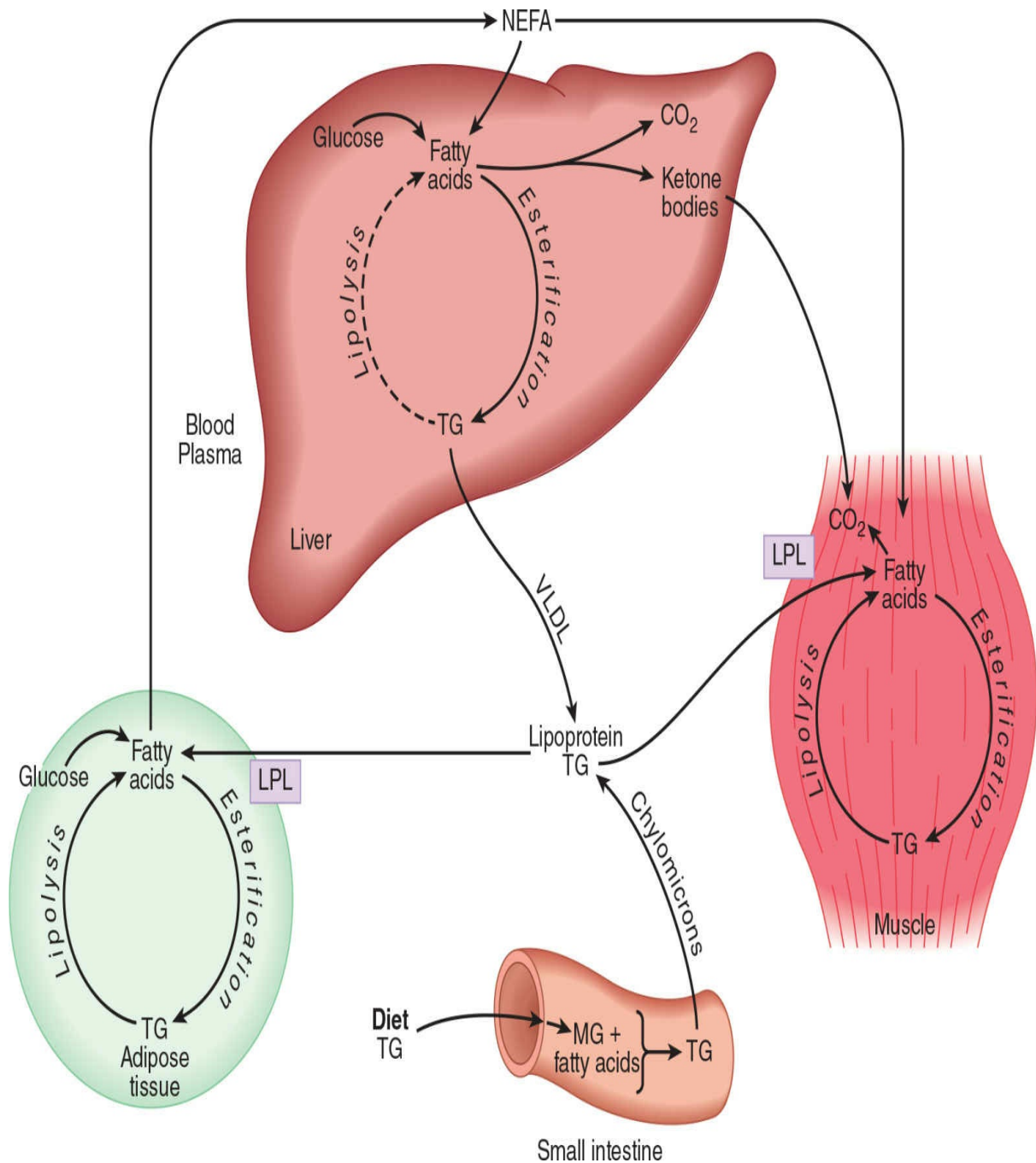

FIGURE 14–6 Transport and fate of major lipid substrates and metabolites. (LPL, lipoprotein lipase; MG, monoacylglycerol; NEFA, nonesterified fatty acids; TG, triacylglycerol; VLDL, very low-density lipoprotein.)

Adipose tissue triacylglycerol is the main fuel reserve of the body. It is hydrolyzed (**lipolysis**) and glycerol and nonesterified (free) fatty acids are released into the circulation. Glycerol is a substrate for gluconeogenesis (see [Chapter 19](#)). The fatty acids are transported bound to serum albumin; they are taken up by most tissues (but not brain or erythrocytes) and either esterified to triacylglycerols for storage or oxidized as a fuel. In the liver, newly synthesized triacylglycerol and triacylglycerol from chylomicron remnants (see [Figure 25–3](#)) is secreted into the circulation in **very low-density lipoprotein (VLDL)**. This triacylglycerol undergoes a fate similar to that of chylomicrons. Partial oxidation of fatty acids in the liver leads to **ketone body** production (**ketogenesis**, [Chapter 22](#)). Ketone bodies are exported to extrahepatic tissues, where they provide a fuel in prolonged fasting and starvation.

At the Subcellular Level, Glycolysis Occurs in the Cytosol & the Citric Acid Cycle in the Mitochondria

Compartmentation of pathways in separate subcellular compartments or organelles permits integration and regulation of metabolism. Not all pathways are of equal importance in all cells. [Figure 14–7](#) depicts the subcellular compartmentation of metabolic pathways in a liver parenchymal cell.

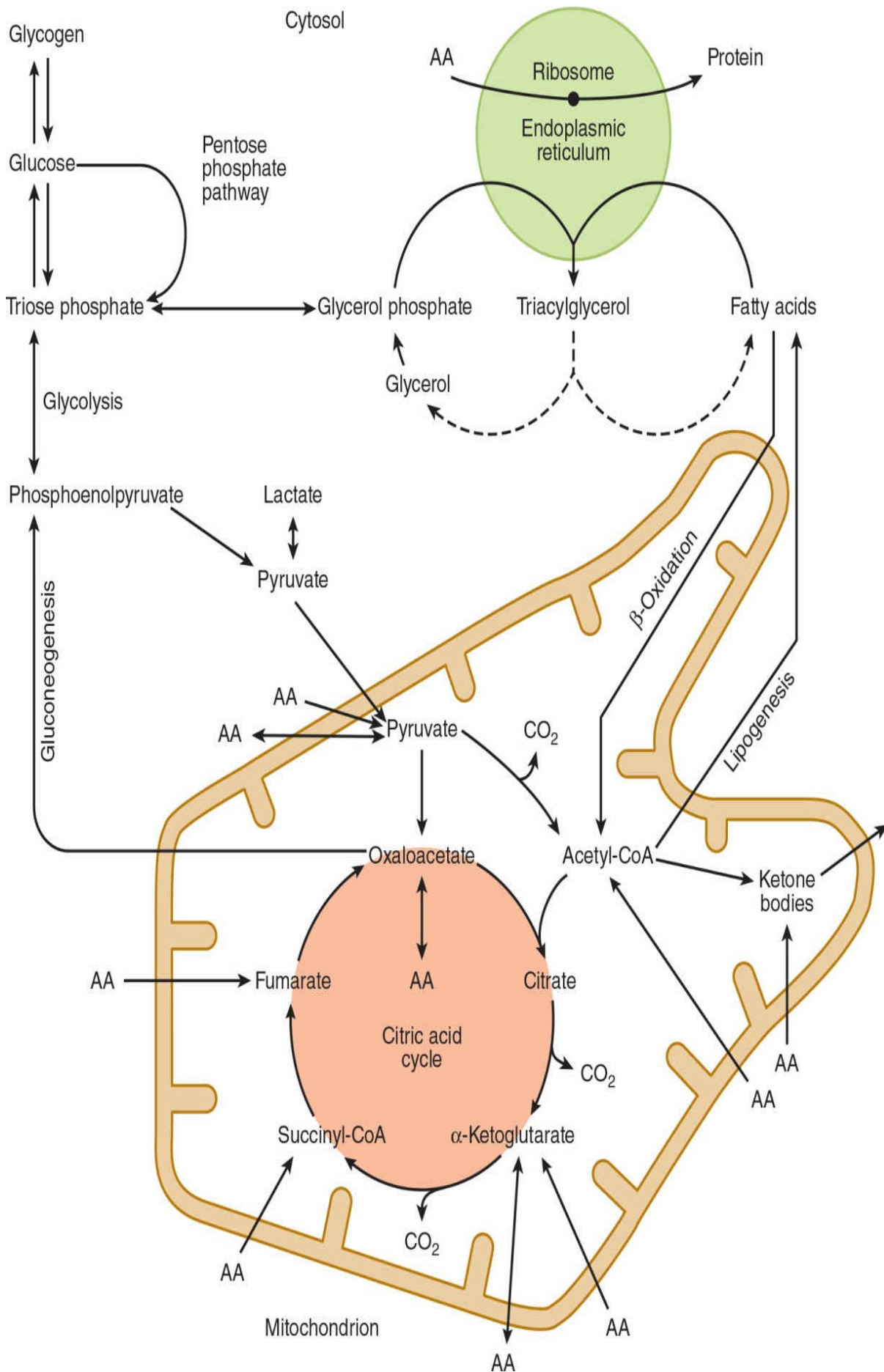

FIGURE 14–7 Intracellular location and overview of major metabolic pathways in a liver parenchymal cell. (AA →, metabolism of one or more essential amino acids; AA ↔, metabolism of one or more nonessential amino acids.)

The central role of the **mitochondrion** is immediately apparent, since it acts as the focus of carbohydrate, lipid, and amino acid metabolism. It contains the enzymes of the citric acid cycle (see [Chapter 16](#)), β -oxidation of fatty acids and ketogenesis (see [Chapter 22](#)), as well as the respiratory chain and ATP synthase (see [Chapter 13](#)).

Glycolysis (see [Chapter 17](#)), the pentose phosphate pathway (see [Chapter 20](#)), and fatty acid synthesis (see [Chapter 23](#)) all occur in the cytosol. In gluconeogenesis (see [Chapter 19](#)), substrates such as lactate and pyruvate, which are formed in the cytosol, enter the mitochondrion to yield **oxaloacetate** as a precursor for the synthesis of glucose in the cytosol.

The membranes of the **endoplasmic reticulum** contain the enzyme system for **triacylglycerol synthesis** (see [Chapter 24](#)), and the **ribosomes** are responsible for **protein synthesis** (see [Chapter 37](#)).

THE FLUX OF METABOLITES THROUGH METABOLIC PATHWAYS MUST BE REGULATED IN A CONCERTED MANNER

Regulation of the overall flux through a pathway is important to ensure an appropriate supply of the products of that pathway. It is achieved by control of one or more key reactions in the pathway, catalyzed by **regulatory enzymes**. The physicochemical factors that control the rate of an enzyme-catalyzed reaction, such as substrate concentration, are of primary importance in the control of the overall rate of a metabolic pathway (see [Chapter 9](#)).

Nonequilibrium Reactions Are Potential Control Points

In a reaction at equilibrium, the forward and reverse reactions occur at equal rates, and there is therefore no net flux in either direction.



In vivo, under “steady-state” conditions, there is a net flux from left to right because there is a continuous supply of substrate A and continuous removal of product D. In practice, there are normally one or more **nonequilibrium** reactions in a metabolic pathway, where the reactants are present in concentrations that are far from equilibrium. In attempting to reach equilibrium, large losses of free energy occur, making this type of reaction essentially irreversible. Such a pathway has both flow and direction. The enzymes catalyzing nonequilibrium reactions are usually present in low concentration and are subject to a variety of regulatory mechanisms. However, most reactions in metabolic pathways cannot be classified as equilibrium or nonequilibrium, but fall somewhere between the two extremes.

The Flux-Generating Reaction Is the First Reaction in a Pathway That Is Saturated With the Substrate

The flux-generating reaction can be identified as a nonequilibrium reaction in which the K_m of the enzyme is considerably lower than the normal concentration of substrate. The first reaction in glycolysis, catalyzed by hexokinase (see [Figure 17–2](#)), is such a flux-generating step because its K_m for glucose of 0.05 mmol/L is well below the normal blood glucose concentration of 3 to 5 mmol/L. Later reactions then control the rate of flux through the pathway.

ALLOSTERIC & HORMONAL MECHANISMS ARE IMPORTANT IN THE METABOLIC CONTROL OF ENZYME-CATALYZED REACTIONS

In the metabolic pathway shown in [Figure 14–8](#),

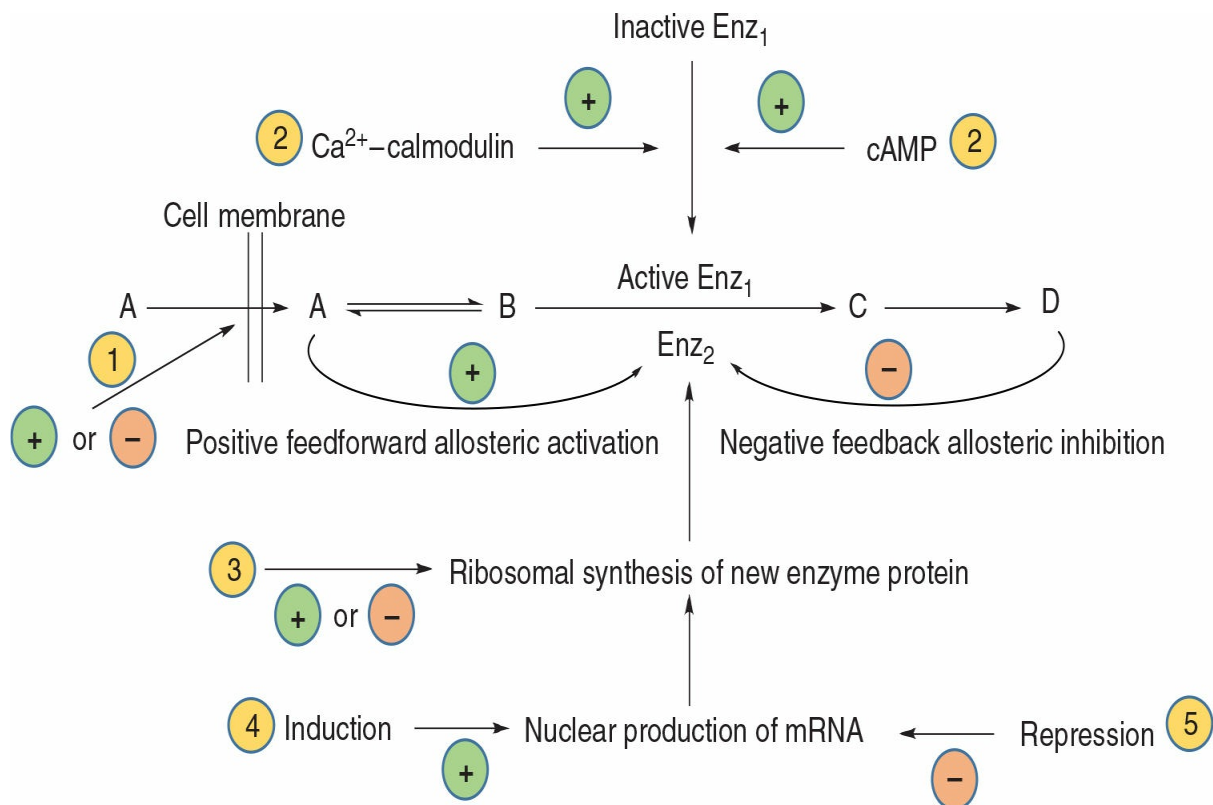
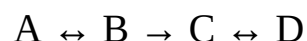

FIGURE 14–8 Mechanisms of control of an enzyme-catalyzed reaction. Circled numbers indicate possible sites of action of hormones: ① alteration of membrane permeability; ② conversion of an inactive to an active enzyme, usually involving phosphorylation/dephosphorylation reactions; ③ alteration of the rate translation of mRNA at the ribosomal level; ④ induction of new mRNA formation; and ⑤ repression of mRNA formation. ① and ② are rapid mechanisms of regulation, whereas ③, ④, and ⑤ are slower.



reactions $A \leftrightarrow B$ and $C \leftrightarrow D$ are equilibrium reactions and $B \rightarrow C$ is a nonequilibrium reaction. The flux through this pathway can be regulated by the availability of substrate A. This depends on its supply from the blood, which in turn depends on either food intake or key reactions that release substrates from tissue reserves into the bloodstream, for example, glycogen phosphorylase in liver (see Figure 18–1) and hormone-sensitive lipase in adipose tissue (see Figure 25–8). It also depends on the transport of substrate A into the cell. Muscle and adipose tissue only take up glucose from the bloodstream in response to the hormone insulin.

Flux is also determined by removal of the end product D and the availability of cosubstrates or cofactors represented by X and Y. Enzymes

catalyzing nonequilibrium reactions are often allosteric proteins subject to the rapid actions of “feed-back” or “feed-forward” control by **allosteric modifiers**, in immediate response to the needs of the cell (see [Chapter 9](#)). Frequently, the end product of a biosynthetic pathway inhibits the enzyme catalyzing the first reaction in the pathway. Other control mechanisms depend on the action of **hormones** responding to the needs of the body as a whole; they may act rapidly by altering the activity of existing enzyme molecules, or slowly by altering the rate of enzyme synthesis (see [Chapter 42](#)).

MANY METABOLIC FUELS ARE INTERCONVERTIBLE

Carbohydrate in excess of requirements for immediate energy-yielding metabolism and formation of glycogen reserves in muscle and liver can readily be used for synthesis of fatty acids, and hence triacylglycerol in both adipose tissue and liver (whence it is exported in very low-density lipoprotein). The importance of lipogenesis in human beings is unclear; in Western countries dietary fat provides 35 to 45% of energy intake, while in less-developed countries, where carbohydrate may provide 60 to 75% of energy intake, the total intake of food is so low that there is little surplus for lipogenesis anyway. A high intake of fat inhibits lipogenesis in adipose tissue and liver.

Fatty acids (and ketone bodies formed from them) cannot be used for the synthesis of glucose. The reaction of pyruvate dehydrogenase, forming acetyl-CoA, is irreversible, and for every two-carbon unit from acetyl-CoA that enters the citric acid cycle, there is a loss of two carbon atoms as carbon dioxide before oxaloacetate is reformed. This means that acetyl-CoA (and hence any substrates that yield acetyl-CoA) can never be used for gluconeogenesis. The (relatively rare) fatty acids with an odd number of carbon atoms yield propionyl-CoA as the product of the final cycle of β -oxidation, and this can be a substrate for gluconeogenesis, as can the glycerol released by lipolysis of adipose tissue triacylglycerol reserves.

Most of the amino acids in excess of requirements for protein synthesis (arising from the diet or from tissue protein turnover) yield pyruvate, or four- and five-carbon intermediates of the citric acid cycle (see [Chapter 29](#)). Pyruvate can be carboxylated to oxaloacetate, which is the primary substrate for gluconeogenesis, and the other intermediates of the cycle also result in a net increase in the formation of oxaloacetate, which is then available for gluconeogenesis. These amino acids are classified as

glucogenic. Two amino acids (lysine and leucine) yield only acetyl-CoA on oxidation, and hence cannot be used for gluconeogenesis, and four others (phenylalanine, tyrosine, tryptophan, and isoleucine) give rise to both acetyl-CoA and intermediates that can be used for gluconeogenesis. Those amino acids that give rise to acetyl-CoA are referred to as **ketogenic**, because in prolonged fasting and starvation, much of the acetyl-CoA is used for synthesis of ketone bodies in the liver.

A SUPPLY OF METABOLIC FUELS IS PROVIDED IN BOTH THE FED & FASTING STATES

Glucose Is Always Required by the Central Nervous System and Erythrocytes

Erythrocytes lack mitochondria and hence are wholly reliant on (anaerobic) glycolysis and the pentose phosphate pathway at all times. The brain can metabolize ketone bodies to meet about 20% of its energy requirements; the remainder must be supplied by glucose. The metabolic changes that occur in the fasting state and starvation serve to preserve glucose and the body's limited glycogen reserves for use by the brain and red blood cells, and to provide alternative metabolic fuels for other tissues. In pregnancy, the fetus requires a significant amount of glucose, as does the synthesis of lactose in lactation (**Figure 14-9**).

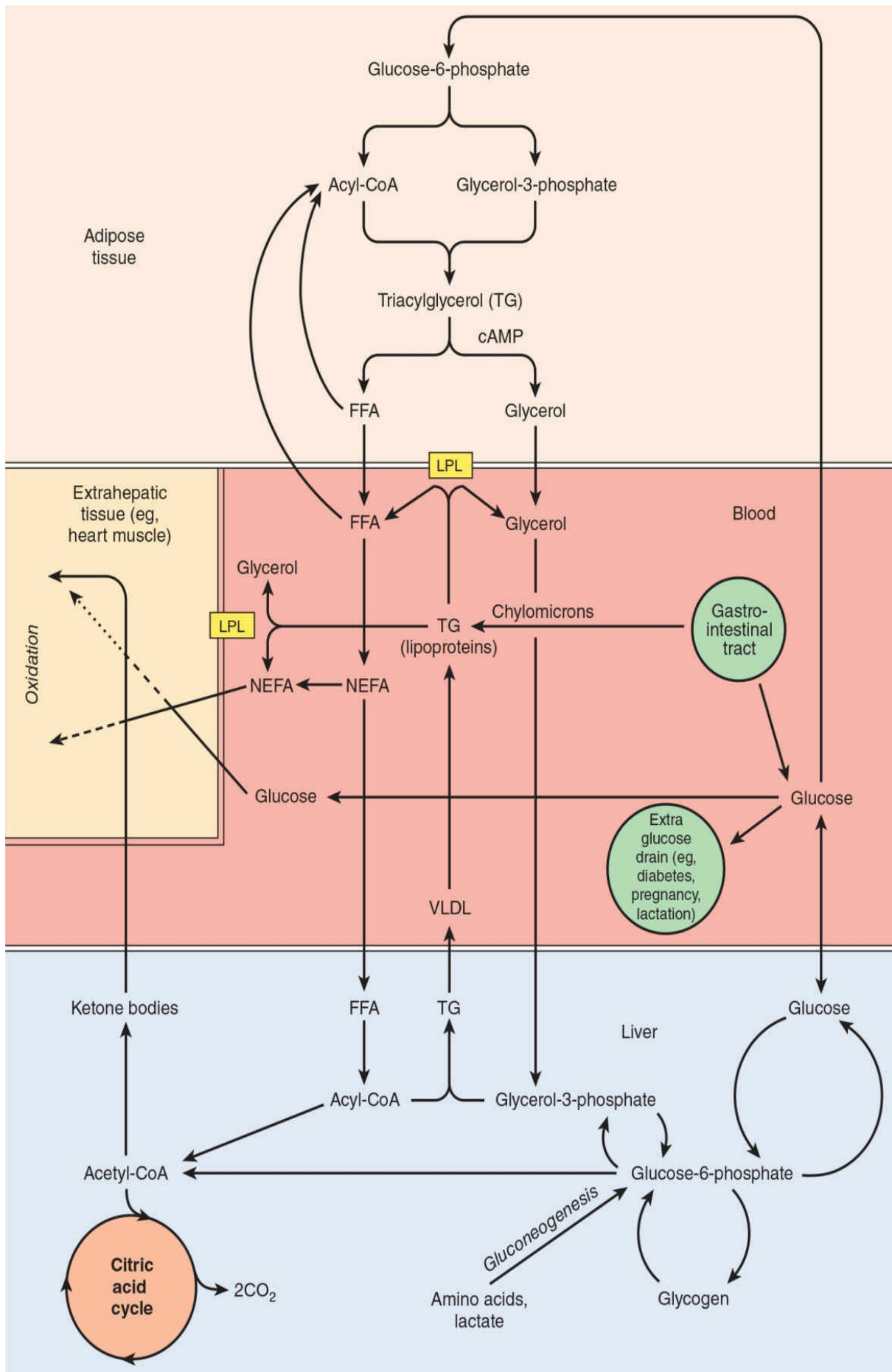

FIGURE 14–9 Metabolic interrelationships among adipose tissue, the liver, and extrahepatic tissues. In tissues such as heart, metabolic fuels are oxidized in the following order of preference: ketone bodies > fatty acids > glucose. (LPL, lipoprotein lipase; NEFA, nonesterified fatty acids; VLDL, very low-density lipoproteins.)

In the Fed State, Metabolic Fuel Reserves Are Laid Down

For several hours after a meal, while the products of digestion are being absorbed, there is an abundant supply of metabolic fuels. Under these conditions, glucose is the major fuel for oxidation in most tissues; this is observed as an increase in the respiratory quotient (the ratio of carbon dioxide produced/oxygen consumed) from about 0.8 in the fasting state to near 1 (**Table 14–1**).

TABLE 14–1 Energy Yields, Oxygen Consumption, and Carbon Dioxide Production in the Oxidation of Metabolic Fuels

	Energy Yield (kJ/g)	O ₂ Consumed (L/g)	CO ₂ Produced (L/g)	RQ (CO ₂ Produced/ O ₂ Consumed)	Energy (kJ)/L O ₂
Carbohydrate	16	0.829	0.829	1.00	~20
Protein	17	0.966	0.782	0.81	~20
Fat	37	2.016	1.427	0.71	~20
Alcohol	29	1.429	0.966	0.66	~20

Glucose uptake into muscle and adipose tissue is controlled by **insulin**, which is secreted by the β -islet cells of the pancreas in response to an increased concentration of glucose in the portal blood. In the fasting state, the glucose transporter of muscle and adipose tissue (GLUT-4) is in intracellular vesicles. An early response to insulin is the migration of these vesicles to the cell surface, where they fuse with the plasma membrane, exposing active glucose transporters. These insulin-sensitive tissues only take up glucose from the bloodstream to any significant extent in the presence of the hormone. As insulin secretion falls in the fasting state, so the transporters are internalized again, reducing glucose uptake. However, in skeletal muscle, the increase in cytoplasmic calcium ion concentration in response to nerve stimulation stimulates the migration of the vesicles to

the cell surface and exposure of active glucose transporters whether there is significant insulin stimulation or not.

The uptake of glucose into the liver is independent of insulin, but liver has an isoenzyme of hexokinase (glucokinase) with a high K_m , so that as the concentration of glucose entering the liver increases, so does the rate of synthesis of glucose-6-phosphate. This is in excess of the liver's requirement for energy-yielding metabolism, and is used mainly for synthesis of **glycogen**. In both liver and skeletal muscle, insulin acts to stimulate glycogen synthetase and inhibit glycogen phosphorylase. Some of the additional glucose entering the liver may also be used for lipogenesis and hence triacylglycerol synthesis. In adipose tissue, insulin stimulates glucose uptake, its conversion to fatty acids, and their esterification to triacylglycerol. It inhibits intracellular lipolysis and the release of nonesterified fatty acids.

The products of lipid digestion enter the circulation as **chylomicrons**, the largest of the plasma lipoproteins, which are especially rich in triacylglycerol (see [Chapter 25](#)). In adipose tissue and skeletal muscle, extracellular lipoprotein lipase is synthesized and activated in response to insulin; the resultant nonesterified fatty acids are largely taken up by the tissue and used for synthesis of triacylglycerol, while the glycerol remains in the bloodstream and is taken up by the liver and used for either gluconeogenesis and glycogen synthesis or lipogenesis. Fatty acids remaining in the bloodstream are taken up by the liver and reesterified. The lipid-depleted chylomicron remnants are cleared by the liver, and the remaining triacylglycerol is exported, together with that synthesized in the liver, in **very low-density lipoprotein**.

Under normal conditions, the rate of tissue protein catabolism is more or less constant throughout the day; it is only in **cachexia** associated with advanced cancer and other diseases that there is an increased rate of protein catabolism. There is net protein catabolism in the fasting state, when the rate of protein synthesis falls, and net protein synthesis in the fed state, when the rate of synthesis increases by 20 to 25%. The increased rate of protein synthesis in response to increased availability of amino acids and metabolic fuel is again a response to insulin. Protein synthesis is an energy expensive process; it may account for up to 20% of resting energy expenditure after a meal, but only 9% in the fasting state.

Metabolic Fuel Reserves Are Mobilized in the Fasting State

There is a small fall in plasma glucose in the fasting state, and then little change as fasting is prolonged into starvation. Plasma nonesterified fatty acids increase in fasting, but then rise little more in starvation; as fasting is prolonged, the plasma concentration of ketone bodies (acetoacetate and 3-hydroxybutyrate) increases markedly (**Table 14–2**, **Figure 14–10**).

TABLE 14–2 Plasma Concentrations of Metabolic Fuels (mmol/L) in the Fed and Fasting States

	Fed	40-h Fasting	7 Days Starvation
Glucose	5.5	3.6	3.5
Nonesterified fatty acids	0.30	1.15	1.19
Ketone bodies	Negligible	2.9	4.5

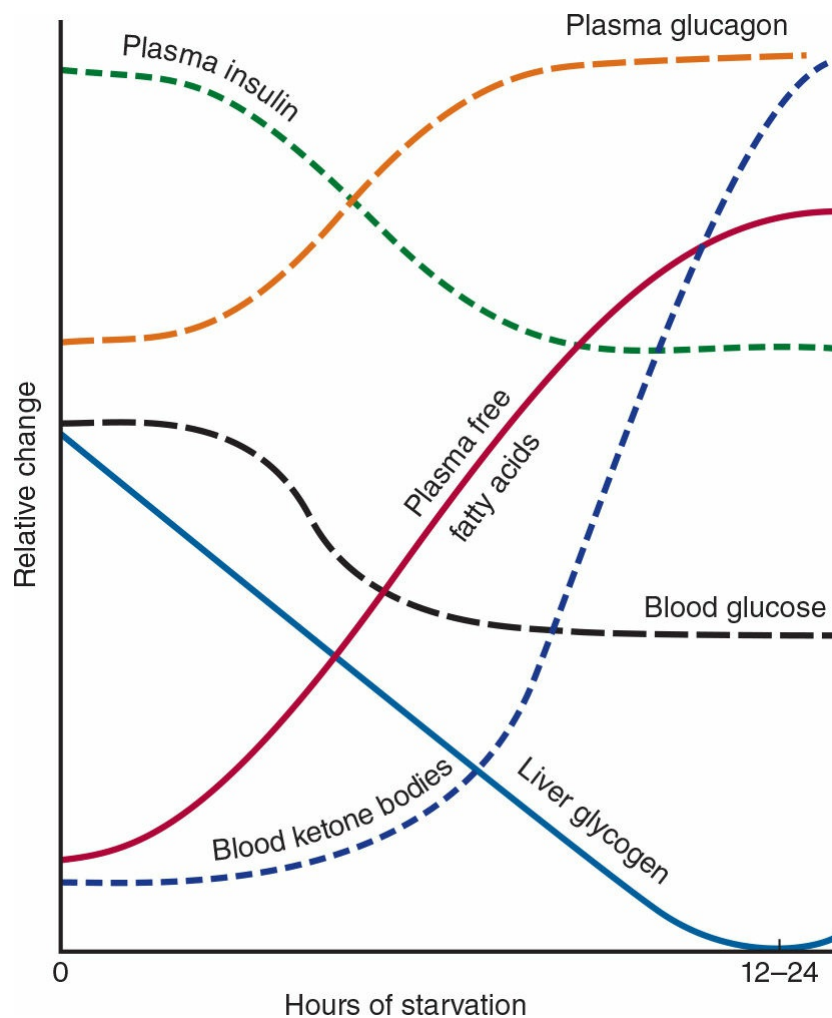

FIGURE 14–10 Relative changes in plasma hormones and metabolic fuels during the onset of starvation.

In the fasting state, as the concentration of glucose in the portal blood coming from the small intestine falls, insulin secretion decreases, and skeletal muscle and adipose tissue take up less glucose. The increase in secretion of **glucagon** by α -cells of the pancreas inhibits glycogen synthetase, and activates glycogen phosphorylase in the liver. The resulting glucose-6-phosphate is hydrolyzed by glucose-6-phosphatase, and glucose is released into the bloodstream for use by the brain and erythrocytes.

Muscle glycogen cannot contribute directly to plasma glucose, since muscle lacks glucose-6-phosphatase, and the primary use of muscle glycogen is to provide a source of glucose-6-phosphate for energy-yielding metabolism in the muscle itself. However, acetyl-CoA formed by oxidation of fatty acids in muscle inhibits pyruvate dehydrogenase, leading to an accumulation of pyruvate. Most of this is transaminated to alanine, at the expense of amino acids arising from breakdown of muscle protein. The alanine, and much of the keto acids resulting from this transamination are exported from muscle, and taken up by the liver, where the alanine is transaminated to yield pyruvate. The resultant amino acids are largely exported back to muscle, to provide amino groups for formation of more alanine, while the pyruvate provides a substrate for gluconeogenesis in the liver.

In adipose tissue, the decrease in insulin and increase in glucagon results in inhibition of lipogenesis, inactivation and internalization of lipoprotein lipase, and activation of intracellular hormone-sensitive lipase (see [Chapter 25](#)). This leads to release from adipose tissue of increased amounts of glycerol (which is a substrate for gluconeogenesis in the liver) and nonesterified fatty acids, which are used by liver, heart, and skeletal muscle as their preferred metabolic fuel, so sparing glucose.

Although muscle preferentially takes up and metabolizes nonesterified fatty acids in the fasting state, it cannot meet all of its energy requirements by β -oxidation. By contrast, the liver has a greater capacity for β -oxidation than is required to meet its own energy needs, and as fasting becomes more prolonged, it forms more acetyl-CoA than can be oxidized. This acetyl-CoA is used to synthesize the **ketone bodies** (see [Chapter 22](#)), which are major metabolic fuels for skeletal and heart muscle and can meet up to 20% of the brain's energy needs. In prolonged starvation, glucose may represent less than 10% of whole body energy-yielding metabolism.

Were there no other source of glucose, liver and muscle glycogen would be exhausted after about 18 hours fasting. As fasting becomes more

prolonged, so an increasing amount of the amino acids released as a result of protein catabolism is utilized in the liver and kidneys for gluconeogenesis (**Table 14–3**).

TABLE 14–3 Summary of the Major Metabolic Features of the Principal Organs

Organ	Major Pathways	Main Substrates	Major Products Exported	Specialist Enzymes
Liver	Glycolysis, gluconeogenesis, lipogenesis, β -oxidation, citric acid cycle, ketogenesis, lipoprotein metabolism, drug metabolism, synthesis of bile salts, urea, uric acid, cholesterol, plasma proteins	Nonesterified fatty acids, glucose (in fed state), lactate, glycerol, fructose, amino acids, alcohol	Glucose, triacylglycerol in VLDL, ^a ketone bodies, urea, uric acid, bile salts, cholesterol, plasma proteins	Glucokinase, glucose-6-phosphatase, glycerol kinase, phosphoenolpyruvate carboxykinase, fructokinase, arginase, HMG-CoA synthase, HMG-CoA lyase, alcohol dehydrogenase
Brain	Glycolysis, citric acid cycle, amino acid metabolism, neurotransmitter synthesis	Glucose, amino acids, ketone bodies in prolonged starvation	Lactate, end products of neurotransmitter metabolism	Those for synthesis and catabolism of neurotransmitters
Heart	β -Oxidation and citric acid cycle	Ketone bodies, nonesterified fatty acids, lactate, chylomicron and VLDL triacylglycerol, some glucose	—	Lipoprotein lipase, very active electron transport chain
Adipose tissue	Lipogenesis, esterification of fatty acids, lipolysis (in fasting)	Glucose, chylomicron, and VLDL triacylglycerol	Nonesterified fatty acids, glycerol	Lipoprotein lipase, hormone-sensitive lipase, enzymes of the pentose phosphate pathway
Fast twitch muscle	Glycolysis	Glucose, glycogen	Lactate, (alanine and ketoacids in fasting)	—
Slow twitch muscle	β -Oxidation and citric acid cycle	Ketone bodies, chylomicron, and VLDL triacylglycerol	—	Lipoprotein lipase, very active electron transport chain
Kidney	Gluconeogenesis	Nonesterified fatty acids, lactate, glycerol, glucose	Glucose	Glycerol kinase, phosphoenolpyruvate carboxykinase
Erythrocytes	Anaerobic glycolysis, pentose phosphate pathway	Glucose	Lactate	Hemoglobin, enzymes of pentose phosphate pathway

^aVLDL, very low-density lipoprotein.

CLINICAL ASPECTS

In prolonged starvation, as adipose tissue reserves are depleted, there is a very considerable increase in the net rate of protein catabolism to provide amino acids, not only as substrates for gluconeogenesis, but also as the main metabolic fuel of all tissues. Death results when essential tissue proteins are catabolized and not replaced. In patients with **cachexia** as a result of release of **cytokines** in response to tumors and disease, there is an increase in the rate of tissue protein catabolism, as well as a considerably increased metabolic rate, so they are in a state of advanced starvation. Again, death results when essential tissue proteins are catabolized and not replaced.

The high demand for glucose by the fetus, and for lactose synthesis in lactation, can lead to ketosis. This may be seen as mild ketosis with hypoglycemia in human beings; in lactating cattle and in ewes carrying a twin pregnancy, there may be very pronounced ketoacidosis and profound hypoglycemia.

In poorly controlled type 1 **diabetes mellitus**, patients may become hyperglycemic, both as a result of lack of insulin to stimulate uptake and utilization of glucose, and because in the absence of insulin to antagonize the actions of glucagon, there is increased gluconeogenesis from amino acids in the liver. At the same time, the lack of insulin to antagonize the actions of glucagon results in increased lipolysis in adipose tissue, and the resultant nonesterified fatty acids are substrates for ketogenesis in the liver.

Utilization of the ketone bodies in muscle (and other tissues) may be impaired because of the lack of oxaloacetate (all tissues have a requirement for some glucose metabolism to maintain an adequate amount of oxaloacetate for citric acid cycle activity). In uncontrolled diabetes, the ketosis may be severe enough to result in pronounced acidosis (**ketoacidosis**); acetoacetate and 3-hydroxybutyrate are relatively strong acids. Coma results from both the acidosis and also the considerably increased osmolality of extracellular fluid (mainly as a result of the hyperglycemia, and diuresis resulting from the excretion of glucose and ketone bodies in the urine).

SUMMARY

- The products of digestion provide the tissues with the building blocks for the biosynthesis of complex molecules and also with the fuel for

metabolic processes.

- Nearly all products of digestion of carbohydrate, fat, and protein are metabolized to a common metabolite, acetyl-CoA, before oxidation to CO₂ in the citric acid cycle.
- Acetyl-CoA is also the precursor for synthesis of long-chain fatty acids and steroids (including cholesterol) and ketone bodies.
- Glucose provides carbon skeletons for the glycerol of triacylglycerols and nonessential amino acids.
- Water-soluble products of digestion are transported directly to the liver via the hepatic portal vein. The liver regulates the concentrations of glucose and amino acids available to other tissues. Lipids and lipid-soluble products of digestion enter the bloodstream from the lymphatic system, and the liver clears the remnants after extrahepatic tissues have taken up fatty acids.
- Pathways are compartmentalized within the cell. Glycolysis, glycogenesis, glycogenolysis, the pentose phosphate pathway, and lipogenesis occur in the cytosol. The mitochondria contain the enzymes of the citric acid cycle and for β-oxidation of fatty acids, as well as the respiratory chain and ATP synthase. The membranes of the endoplasmic reticulum contain the enzymes for a number of other processes, including triacylglycerol synthesis and drug metabolism.
- Metabolic pathways are regulated by rapid mechanisms affecting the activity of existing enzymes, that is, allosteric and covalent modification (often in response to hormone action) and slow mechanisms that affect the synthesis of enzymes.
- Dietary carbohydrate and amino acids in excess of requirements can be used for fatty acid and hence triacylglycerol synthesis.
- In fasting and starvation, glucose must be provided for the brain and red blood cells; in the early fasting state, this is supplied from glycogen reserves. In order to spare glucose, muscle and other tissues do not take up glucose when insulin secretion is low; they utilize fatty acids (and later ketone bodies) as their preferred fuel.
- Adipose tissue releases nonesterified fatty acids in the fasting state. In prolonged fasting and starvation, these are used by the liver for synthesis of ketone bodies, which are exported to provide the major fuel for muscle.
- Most amino acids, arising from the diet or from tissue protein turnover, can be used for gluconeogenesis, as can the glycerol from triacylglycerol.

- Neither fatty acids, arising from the diet or from lipolysis of adipose tissue triacylglycerol, nor ketone bodies, formed from fatty acids in the fasting state, can provide substrates for gluconeogenesis.

Carbohydrates of Physiological Significance

David A. Bender, PhD & Peter A. Mayes, PhD, DSc

OBJECTIVES

After studying this chapter, you should be able to:

- Explain what is meant by the glycome, glycobiology, and the science of glycomics.
- Explain what is meant by the terms monosaccharide, disaccharide, oligosaccharide, and polysaccharide.
- Explain the different ways in which the structures of glucose and other monosaccharides can be represented, and describe the various types of isomerism of sugars and the pyranose and furanose ring structures.
- Describe the formation of glycosides and the structures of the important disaccharides and polysaccharides.
- Explain what is meant by the glycemic index of a carbohydrate.
- Describe the roles of carbohydrates in cell membranes and lipoproteins.

BIOMEDICAL IMPORTANCE

Carbohydrates are widely distributed in plants and animals; they have important structural and metabolic roles. In plants, glucose is synthesized from carbon dioxide and water by photosynthesis and stored as starch or used to synthesize the cellulose of the plant cell walls. Animals can synthesize carbohydrates from amino acids, but most are derived ultimately from plants. **Glucose** is the most important carbohydrate; most dietary carbohydrate is absorbed into the bloodstream as glucose formed by hydrolysis of dietary starch and disaccharides, and other sugars are converted to glucose in the liver. Glucose is the major metabolic fuel of mammals (except ruminants) and a universal fuel of the fetus. It is the precursor for synthesis of all the other carbohydrates in the body, including **glycogen** for storage, **ribose** and **deoxyribose** in nucleic acids, **galactose** for synthesis of lactose in milk, in glycolipids, and in combination with protein in glycoproteins (see [Chapter 46](#)) and proteoglycans. Diseases associated with carbohydrate metabolism include **diabetes mellitus**, **galactosemia**, **glycogen storage diseases**, and **lactose intolerance**.

Glycobiology is the study of the roles of sugars in health and disease. The **glycome** is the entire complement of sugars of an organism, whether free or in more complex molecules. **Glycomics**, an analogous term to genomics and proteomics, is the comprehensive study of glycomes, including genetic, physiological, pathological, and other aspects.

A very large number of glycoside links can be formed between sugars. For example, three different hexoses may be linked to each other to form over 1000 different trisaccharides. The conformations of the sugars in oligosaccharide chains vary depending on their linkages and proximity to other molecules with which the oligosaccharides may interact. Oligosaccharide chains encode **biological information** that depends on their constituent sugars, sequences, and linkages.

CARBOHYDRATES ARE ALDEHYDE OR KETONE DERIVATIVES OF POLYHYDRIC ALCOHOLS

Carbohydrates are classified as follows:

1. **Monosaccharides** are those sugars that cannot be hydrolyzed into simpler carbohydrates. They may be classified as **trioses**, **tetroses**, **pentoses**, **hexoses**, or **heptoses**, depending on the number of carbon

atoms (3-7), and as **aldoses** or **ketoses**, depending on whether they have an aldehyde or ketone group. Examples are listed in **Table 15–1**. In addition to aldehydes and ketones, the polyhydric alcohols (sugar alcohols or **polyols**), in which the aldehyde or ketone group has been reduced to an alcohol group, also occur naturally in foods. They are synthesized by reduction of monosaccharides for use in the manufacture of foods for weight reduction and for diabetics. They are poorly absorbed, and have about half the energy yield of sugars.

TABLE 15–1 Classification of Important Sugars

	Aldoses	Ketoses
Trioses (C ₃ H ₆ O ₃)	Glycerose (glyceraldehyde)	Dihydroxyacetone
Tetroses (C ₄ H ₈ O ₄)	Erythrose	Erythrulose
Pentoses (C ₅ H ₁₀ O ₅)	Ribose	Ribulose
Hexoses (C ₆ H ₁₂ O ₆)	Glucose, galactose, mannose	Fructose
Heptoses (C ₇ H ₁₄ O ₇)	—	Sedoheptulose

- 2. Disaccharides** are condensation products of two monosaccharide units, for example, lactose, maltose, isomaltose, sucrose, and trehalose.
- 3. Oligosaccharides** are condensation products of 3 to 10 monosaccharides. Most are not digested by human enzymes.
- 4. Polysaccharides** are condensation products of more than 10 monosaccharide units; examples are the starches and dextrans, which may be linear or branched polymers. Polysaccharides are sometimes classified as hexosans or pentosans, depending on the constituent monosaccharides (hexoses or pentoses, respectively). In addition to starches and dextrans (which are hexosans), foods contain a wide variety of other polysaccharides that are collectively known as nonstarch polysaccharides; they are not digested by human enzymes, and are the major component of dietary fiber. Examples are cellulose from plant cell walls (a glucose polymer; see **Figure 15–13**) and inulin, the storage carbohydrate in some plants (a fructose polymer; see **Figure 15–13**).

BIOMEDICALLY, GLUCOSE IS THE MOST IMPORTANT MONOSACCHARIDE

The Structure of Glucose Can Be Represented in Three Ways

The straight-chain structural formula (aldohexose; **Figure 15–1A**) can account for some of the properties of glucose, but a cyclic structure (a **hemiacetal** formed by reaction between the aldehyde group and a hydroxyl group) is thermodynamically favored and accounts for other properties. The cyclic structure is normally drawn as shown in **Figure 15–1B**, the Haworth projection, in which the molecule is viewed from the side and above the plane of the ring; the bonds nearest to the viewer are bold and thickened, and the hydroxyl groups are above or below the plane of the ring. The hydrogen atoms attached to each carbon are not shown in this figure. The ring is actually in the form of a chair (**Figure 15–1C**).

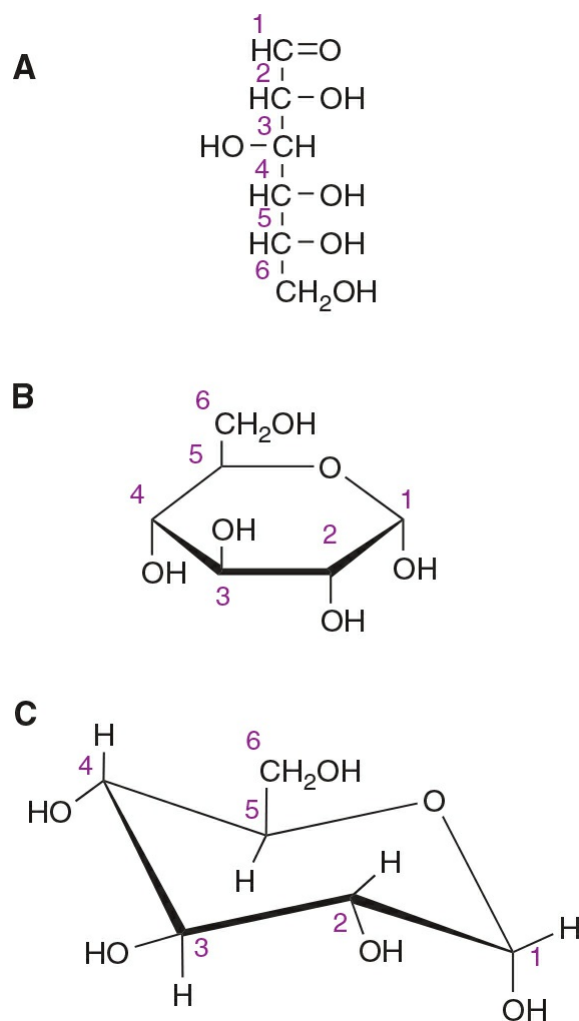

FIGURE 15–1 D-Glucose. (A) Straight-chain form. (B) α -D-glucose;

Haworth projection. (C) α -D-glucose; chair form.

Sugars Exhibit Various Forms of Isomerism

Glucose, with four asymmetric carbon atoms, can form 16 isomers. The more important types of isomerism found with glucose are as follows.

- D- and L-isomerism:** The designation of a sugar isomer as the D form or its mirror image as the L form is determined by its spatial relationship to the parent compound of the carbohydrates, the three-carbon sugar glycerose (glyceraldehyde). The L and D forms of this sugar, and of glucose, are shown in **Figure 15–2**. The orientation of the —H and —OH groups around the carbon atom adjacent to the terminal alcohol carbon (carbon 5 in glucose) determines whether the sugar belongs to the D or L series. When the —OH group on this carbon is on the right (as seen in **Figure 15–2**), the sugar is the D-isomer; when it is on the left, it is the L-isomer. Most of the naturally occurring monosaccharides are D sugars, and the enzymes responsible for their metabolism are specific for this configuration.

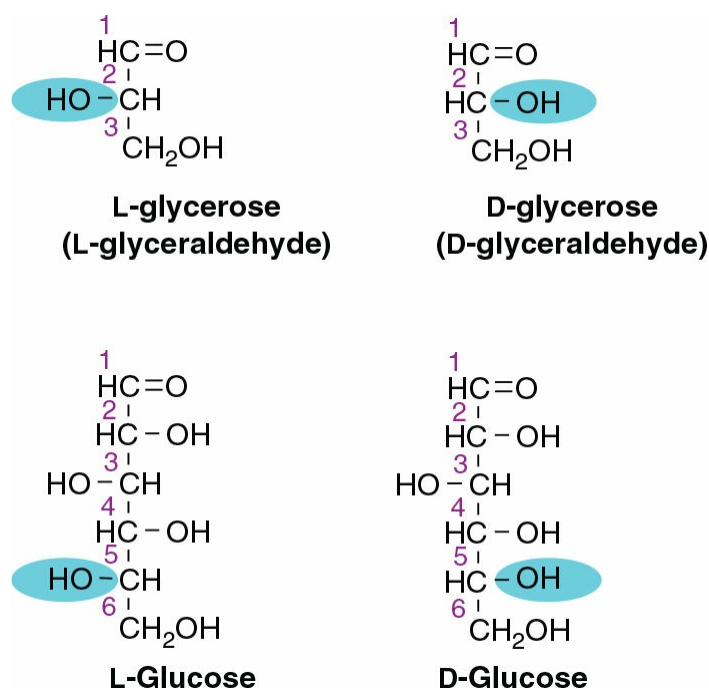

FIGURE 15–2 D- and L-isomerism of glycerose and glucose.

- The presence of asymmetric carbon atoms also confers **optical activity** on the compound. When a beam of plane-polarized light is passed through a solution of an **optical isomer**, it rotates either to the right, dextrorotatory (+), or to the left, levorotatory (–). The direction of

rotation of polarized light is independent of the stereochemistry of the sugar, so it may be designated D(-), D(+), L(-), or L(+). For example, the naturally occurring form of fructose is the D(-) isomer.

Confusingly, dextrorotatory (+) was at one time called d-, and levorotatory (-) l-. This nomenclature is obsolete, but may sometimes be found; it is unrelated to D- and L-isomerism. In solution, glucose is dextrorotatory, and glucose solutions are sometimes known as **dextrose**.

3. **Pyranose and furanose ring structures:** The ring structures of monosaccharides are similar to the ring structures of either pyran (a six-membered ring) or furan (a five-membered ring) (**Figures 15-3** and **15-4**). For glucose in solution, more than 99% is in the pyranose form.

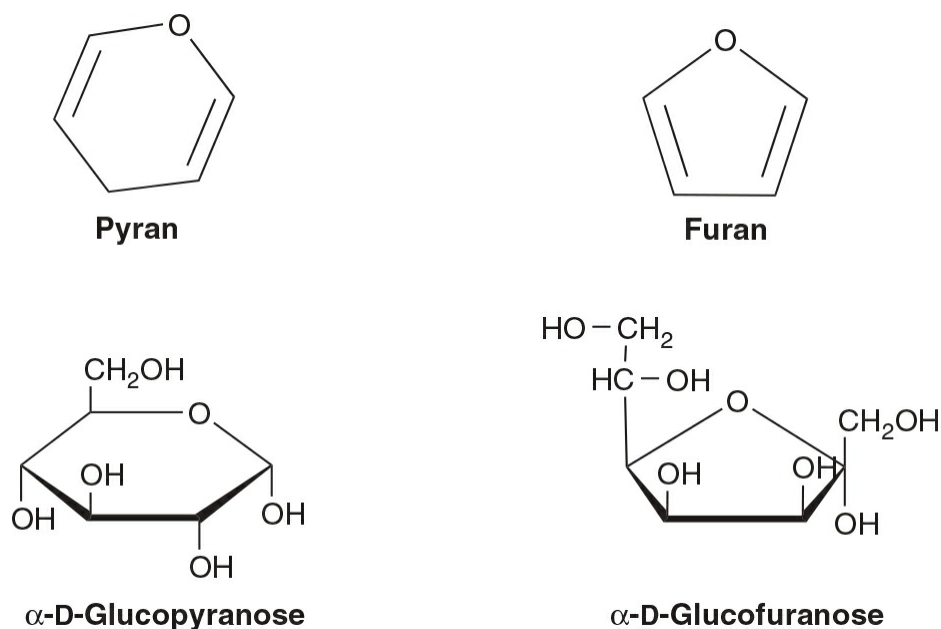

FIGURE 15-3 Pyranose and furanose forms of glucose.

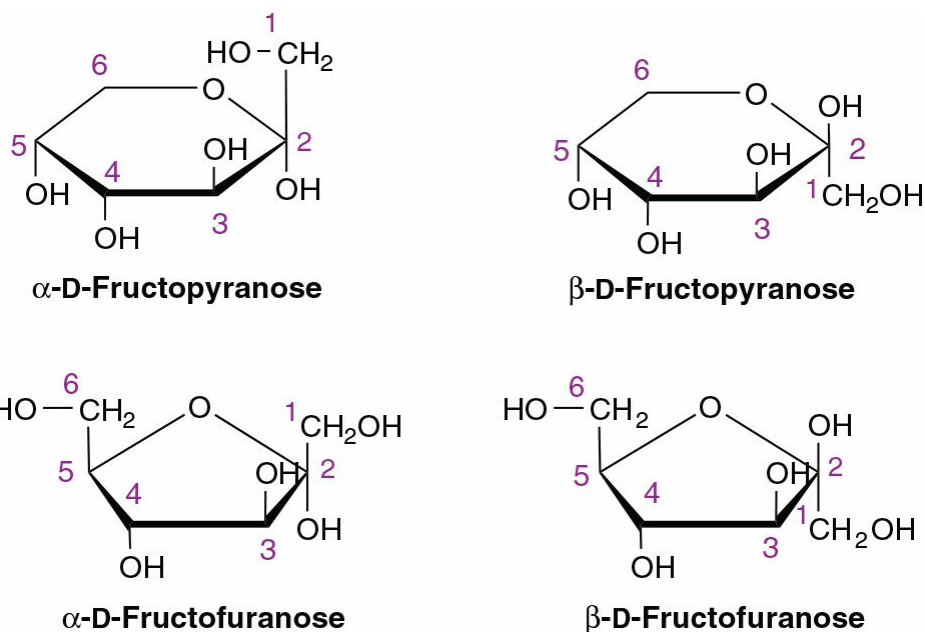

FIGURE 15–4 Pyranose and furanose forms of fructose.

- Alpha- and beta-anomers:** The ring structure of an aldose is a hemiacetal, since it is formed by reaction between an aldehyde and an alcohol group. Similarly, the ring structure of a ketose is a hemiketal. Crystalline glucose is α -D-glucopyranose. The cyclic structure is retained in the solution, but isomerism occurs about position 1, the carbonyl or **anomeric carbon atom**, to give a mixture of α -glucopyranose (38%) and β -glucopyranose (62%). Less than 0.3% is represented by α - and β -anomers of glucofuranose.
- Epimers:** Isomers differing as a result of variations in configuration of the —OH and —H on carbon atoms 2, 3, and 4 of glucose are known as epimers. Biologically, the most important epimers of glucose are mannose (epimerized at carbon 2) and galactose (epimerized at carbon 4) (**Figure 15–5**).

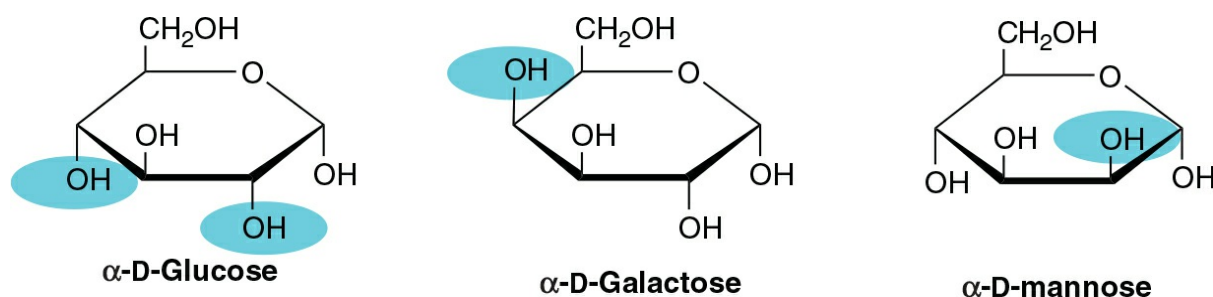

FIGURE 15–5 Epimers of glucose.

- Aldose-ketose isomerism:** Fructose has the same molecular formula

as glucose but differs in that there is a potential keto group in position 2, the anomeric carbon of fructose, whereas in glucose there is a potential aldehyde group in position 1, the anomeric carbon. Examples of aldose and ketose sugars are shown in **Figures 15–6 and 15–7**, respectively. Chemically, aldoses are reducing compounds, and are sometimes known as reducing sugars. This provides the basis for a simple chemical test for glucose in urine in poorly controlled diabetes mellitus, by reduction of an alkaline copper solution (see **Chapter 48**).

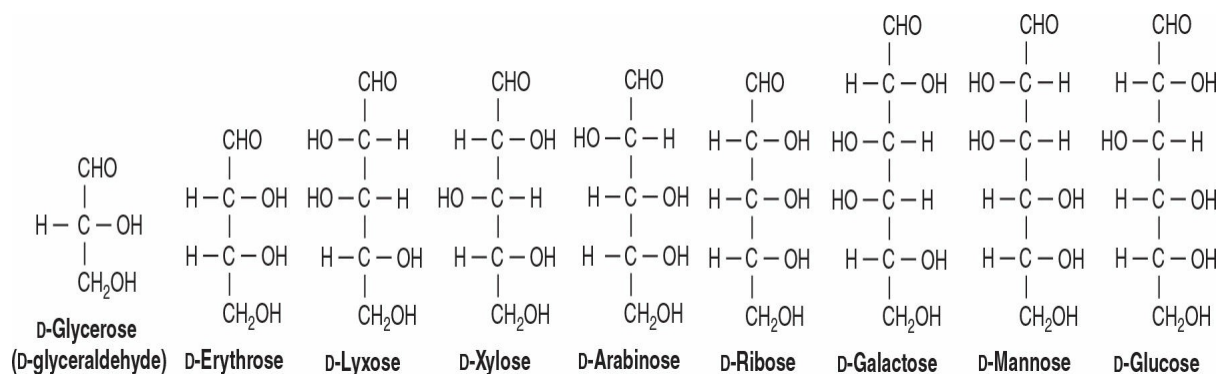

FIGURE 15–6 Examples of aldoses of physiological significance.

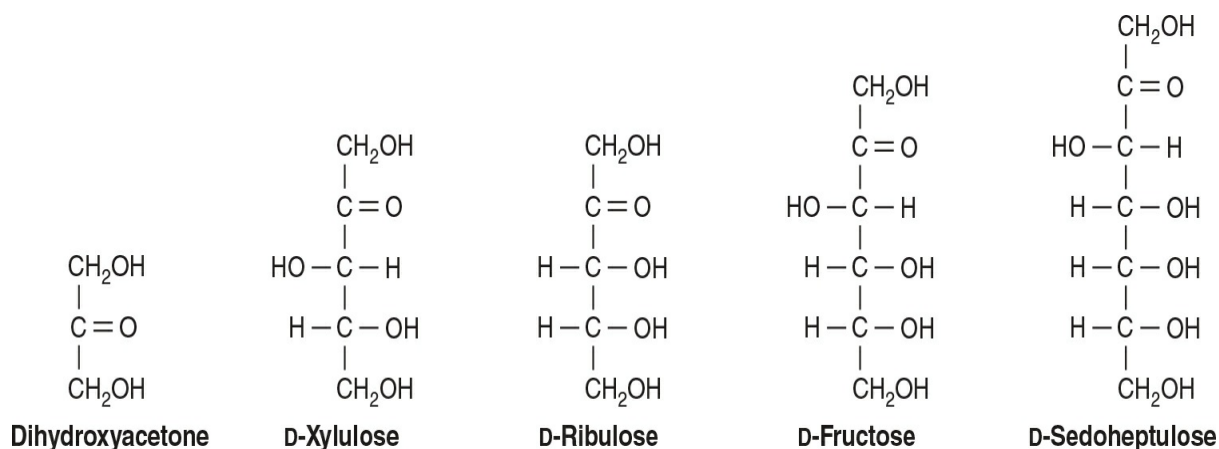

FIGURE 15–7 Examples of ketoses of physiological significance.

Many Monosaccharides Are Physiologically Important

Derivatives of trioses, tetroses, and pentoses and of the seven-carbon sugar sedoheptulose are formed as metabolic intermediates in glycolysis (see **Chapter 17**) and the pentose phosphate pathway (see **Chapter 20**). Pentoses are important in nucleotides, nucleic acids, and several coenzymes (**Table 15–2**). Glucose, galactose, fructose, and mannose are physiologically the

most important hexoses (**Table 15–3**). The biochemically important aldoses are shown in **Figure 15–6**, and ketoses in **Figure 15–7**.

TABLE 15–2 Pentoses of Physiological Importance

Sugar	Source	Biochemical and Clinical Importance
D-Ribose	Nucleic acids and metabolic intermediate	Structural component of nucleic acids and coenzymes, including ATP, NAD(P), and flavin coenzymes
D-Ribulose	Metabolic intermediate	Intermediate in the pentose phosphate pathway
D-Arabinose	Plant gums	Constituent of glycoproteins
D-Xylose	Plant gums, proteoglycans, glycosaminoglycans	Constituent of glycoproteins
L-Xylulose	Metabolic intermediate	Excreted in the urine in essential pentosuria

TABLE 15–3 Hexoses of Physiological Importance

Sugar	Source	Biochemical Importance	Clinical Significance
D-Glucose	Fruit juices, hydrolysis of starch, cane or beet sugar, maltose and lactose	The main metabolic fuel for tissues; “blood sugar”	Excreted in the urine (glucosuria) in poorly controlled diabetes mellitus as a result of hyperglycemia
D-Fructose	Fruit juices, honey, hydrolysis of cane or beet sugar and inulin, enzymic isomerization of glucose syrups for food manufacture	Readily metabolized either via glucose or directly	Hereditary fructose intolerance leads to fructose accumulation and hypoglycemia
D-Galactose	Hydrolysis of lactose	Readily metabolized to glucose; synthesized in the mammary gland for synthesis of lactose in milk. A constituent of glycolipids and glycoproteins	Hereditary galactosemia as a result of failure to metabolize galactose leads to cataracts
D-Mannose	Hydrolysis of plant mannan gums	Constituent of glycoproteins	

In addition, carboxylic acid derivatives of glucose are important, including D-glucuronate (for glucuronide formation and in glycosaminoglycans), its metabolic derivative, L-iduronate (in glycosaminoglycans, **Figure 15–8**) and L-gulonate (an intermediate in the uronic acid pathway; see **Figure 20–4**).

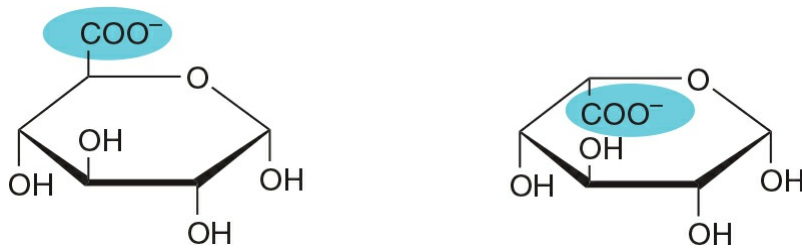

FIGURE 15–8 α -D-Glucuronate (left) and β -L-iduronate (right).

Sugars Form Glycosides With Other Compounds & With Each Other

Glycosides are formed by condensation between the hydroxyl group of the anomeric carbon of a monosaccharide, and a second compound that may be another monosaccharide or, in the case of an **aglycone**, not a sugar. If the second group is also a hydroxyl, the *O*-glycosidic bond is an **acetal** link because it results from a reaction between a hemiacetal group (formed from an aldehyde and an —OH group) and another —OH group. If the hemiacetal portion is glucose, the resulting compound is a **glucoside**; if galactose, a **galactoside**; and so on. If the second group is an amine, an *N*-glycosidic bond is formed, for example, between adenine and ribose in nucleotides such as ATP (see [Figure 11–4](#)).

Glycosides are widely distributed in nature; the aglycone may be methanol, glycerol, a sterol, a phenol, or a base such as adenine. The glycosides that are important in medicine because of their action on the heart (**cardiac glycosides**), all contain steroids as the aglycone. These include derivatives of digitalis and strophanthus such as **ouabain**, an inhibitor of the $\text{Na}^+ - \text{K}^+$ -ATPase of cell membranes. Other glycosides include antibiotics such as **streptomycin**.

Deoxy Sugars Lack an Oxygen Atom

Deoxy sugars are those in which one hydroxyl group has been replaced by hydrogen. An example is **deoxyribose** ([Figure 15–9](#)) in DNA. The deoxy sugar L-fucose (see [Figure 15–15](#)) occurs in glycoproteins; 2-deoxyglucose is used experimentally as an inhibitor of glucose metabolism.

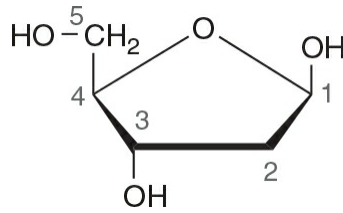

FIGURE 15–9 2-Deoxy-D-ribofuranose (β -form).

Amino Sugars (Hexosamines) Are Components of Glycoproteins, Gangliosides, & Glycosaminoglycans

The amino sugars include D-glucosamine, a constituent of hyaluronic acid (**Figure 15–10**), D-galactosamine (also known as chondrosamine), a constituent of chondroitin, and D-mannosamine. Several **antibiotics** (eg, **erythromycin**) contain amino sugars, which are important for their antibiotic activity.

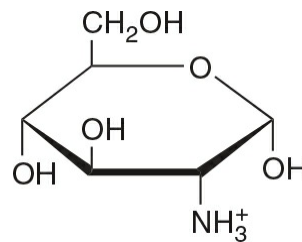

FIGURE 15–10 Glucosamine (2-amino-D-glucopyranose) (α -form).

Galactosamine is 2-amino-D-galactopyranose. Both glucosamine and galactosamine occur as N-acetyl derivatives in complex carbohydrates, for example, glycoproteins.

Maltose, Sucrose, & Lactose Are Important Disaccharides

The disaccharides are sugars composed of two monosaccharide residues linked by a glycoside bond (**Figure 15–11**). The physiologically important disaccharides are maltose, sucrose, and lactose (**Table 15–4**). Hydrolysis of sucrose yields a mixture of glucose and fructose called “invert sugar” because fructose is strongly levorotatory and changes (inverts) the weaker dextrorotatory action of sucrose.

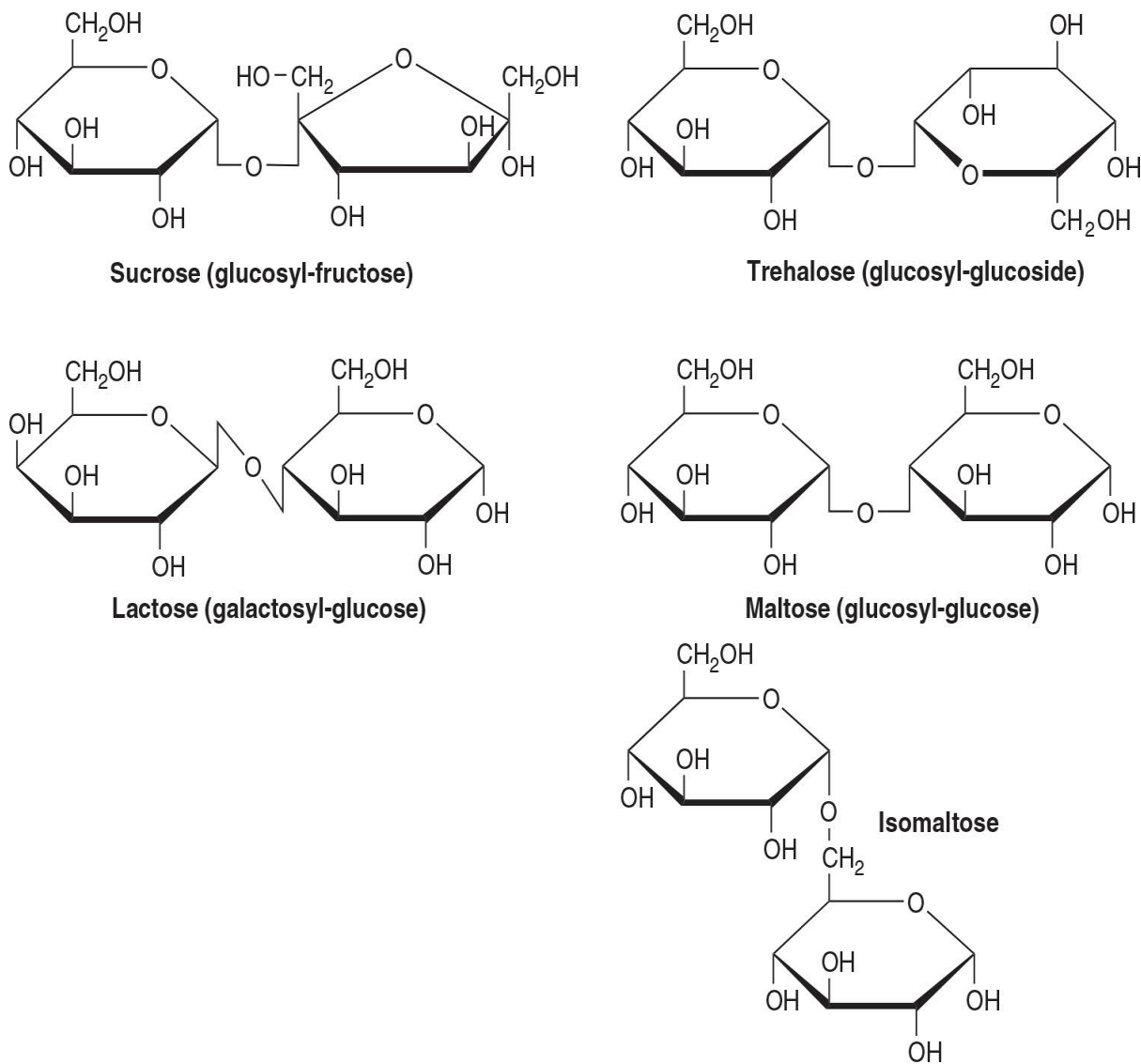

FIGURE 15–11 Structures of nutritionally important disaccharides.

TABLE 15–4 Disaccharides of Physiological Importance

Sugar	Composition	Source	Clinical Significance
Sucrose	O- α -D-glucopyranosyl-(1 \rightarrow 2)- β -D-fructofuranoside	Cane and beet sugar, sorghum and some fruits and vegetables	Rare genetic lack of sucrase leads to sucrose intolerance—diarrhea and flatulence
Lactose	O- β -D-galactopyranosyl-(1 \rightarrow 4)- β -D-glucopyranose	Milk (and many pharmaceutical preparations as a filler)	Lack of lactase (alactasia) leads to lactose intolerance—diarrhea and flatulence; may be excreted in the urine in pregnancy
Maltose	O- α -D-glucopyranosyl-(1 \rightarrow 4)- α -D-glucopyranose	Enzymic hydrolysis of starch (amylase); germinating cereals and malt	
Isomaltose	O- α -D-glucopyranosyl-(1 \rightarrow 6)- α -D-glucopyranose	Enzymic hydrolysis of starch (the branch points in amylopectin)	
Lactulose	O- α -D-galactopyranosyl-(1 \rightarrow 4)- β -D-fructofuranose	Heated milk (small amounts), mainly synthetic	Not hydrolyzed by intestinal enzymes, but fermented by intestinal bacteria; used as a mild osmotic laxative
Trehalose	O- α -D-glucopyranosyl-(1 \rightarrow 1)- α -D-glucopyranoside	Yeasts and fungi; the main sugar of insect hemolymph	

POLYSACCHARIDES SERVE STORAGE & STRUCTURAL FUNCTIONS

Polysaccharides include a number of physiologically important carbohydrates.

Starch is a homopolymer of glucose forming an α -glucosidic chain, called a **glucosan** or **glucan**. It is the most important dietary carbohydrate in cereals, potatoes, legumes, and other vegetables. The two main constituents are **amylose** (13-20%), which has a nonbranching helical structure, and **amylopectin** (80-87%), which consists of branched chains, consists of 24 to 30 glucose residues with α 1 \rightarrow 4 linkages in the chains and by α 1 \rightarrow 6 linkages at the branch points (**Figure 15–12**).

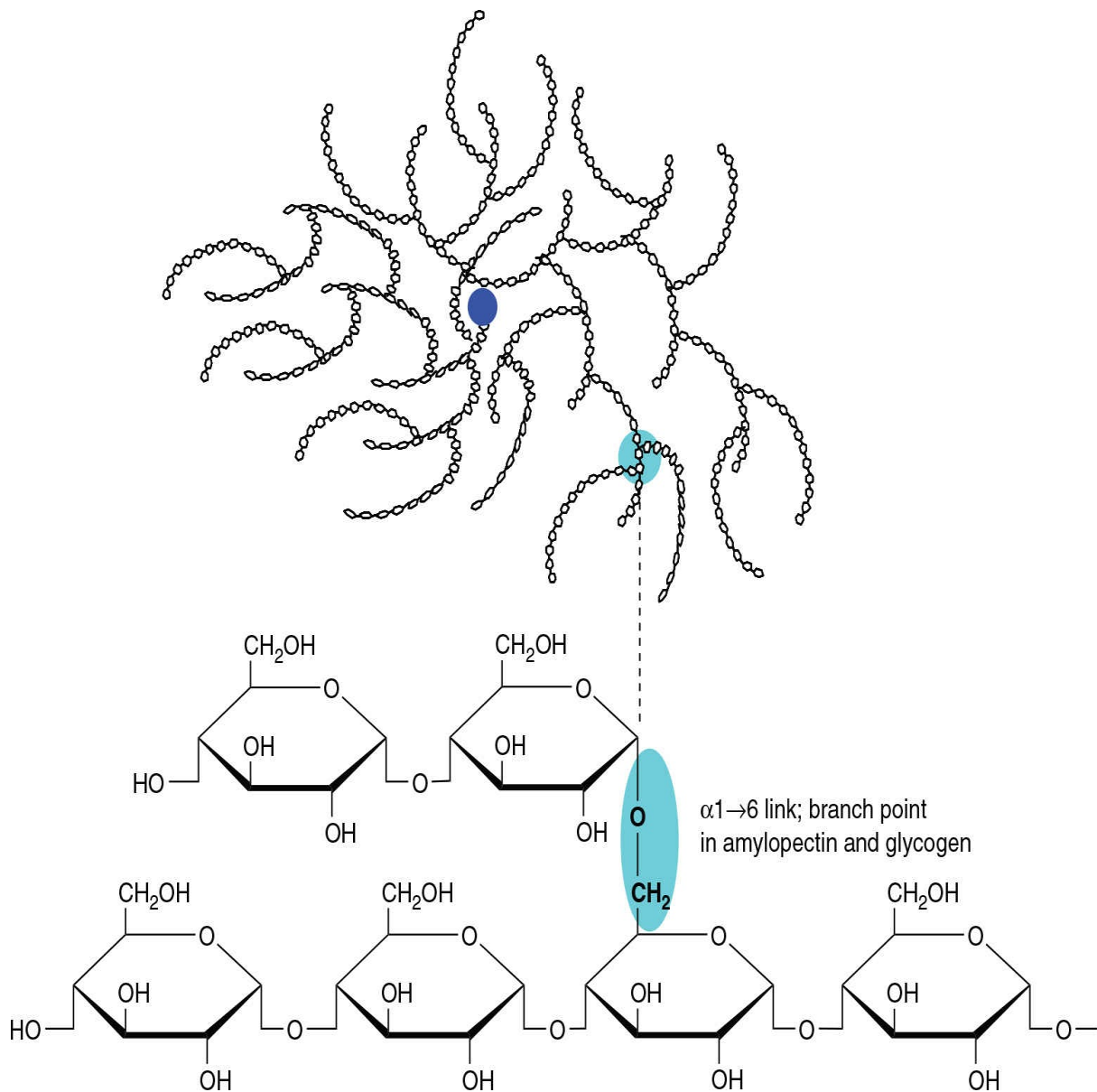

FIGURE 15–12 The structure of starch and glycogen. Amylose is a linear polymer of glucose residues linked α 1 \rightarrow 4, which coils into a helix. Amylopectin and glycogen consist of short chains of glucose residues linked α 1 \rightarrow 4 with branch points formed by α 1 \rightarrow 6 glycoside bonds. The glycogen molecule is a sphere \sim 21 nm in diameter that can be seen in electron micrographs. It has a molecular mass of \sim 10^7 Da and consists of polysaccharide chains, each containing about 13 glucose residues. The chains are either branched or unbranched and are arranged in 12 concentric layers. The branched chains (each has two branches) are found in the inner layers and the unbranched chains in the outermost layer. The blue dot at the center of the glycogen molecule is glycogenin, the primer molecule for glycogen synthesis.

The extent to which starch in foods is hydrolyzed by amylase is determined by its structure, the degree of crystallization or hydration (the result of cooking), and whether it is enclosed in intact (and indigestible) plant cell walls. The **glycemic index** of a starchy food is a measure of its digestibility, based on the extent to which it raises the blood concentration of glucose compared with an equivalent amount of glucose or a reference food such as white bread or boiled rice. Glycemic index ranges from 1 (or 100%) for starches that are readily hydrolyzed in the small intestine to 0 for those that are not hydrolysed at all.

Glycogen is the storage polysaccharide in animals and is sometimes called animal starch. It is a more highly branched structure than amylopectin, with chains of 12 to 15 α -D-glucopyranose residues (in $\alpha 1 \rightarrow 4$ glucosidic linkage) with branching by means of $\alpha 1 \rightarrow 6$ glucosidic bonds. Muscle glycogen granules (β -particles) are spherical and contain up to 60,000 glucose residues; in liver there are similar granules and also rosettes of glycogen granules that appear to be aggregated β -particles.

Inulin is a polysaccharide of fructose (a fructosan) found in tubers and roots of dahlias, artichokes, and dandelions. It is readily soluble in water and is used to determine the glomerular filtration rate, but it is not hydrolyzed by intestinal enzymes, so has no nutritional value. **Dextrins** are intermediates in the hydrolysis of starch. **Cellulose** is the chief constituent of plant cell walls. It is insoluble and consists of β -D-glucopyranose units linked by $\beta 1 \rightarrow 4$ bonds to form long, straight chains strengthened by cross-linking hydrogen bonds. Mammals lack any enzyme that hydrolyzes the $\beta 1 \rightarrow 4$ bonds, and so cannot digest cellulose. It is the major component of dietary fiber. Microorganisms in the gut of ruminants and other herbivores can hydrolyze the linkage and ferment the products to short-chain fatty acids as a major energy source. There is some bacterial metabolism of cellulose in the human colon. **Chitin** is a structural polysaccharide in the exoskeleton of crustaceans and insects, and also in mushrooms. It consists of *N*-acetyl-D-glucosamine units joined by $\beta 1 \rightarrow 4$ glycosidic bonds. **Pectin** occurs in fruits; it is a polymer of galacturonic acid linked $\alpha 1 \rightarrow 4$, with some galactose an/or arabinose branches, and is partially methylated (**Figure 15–13**).

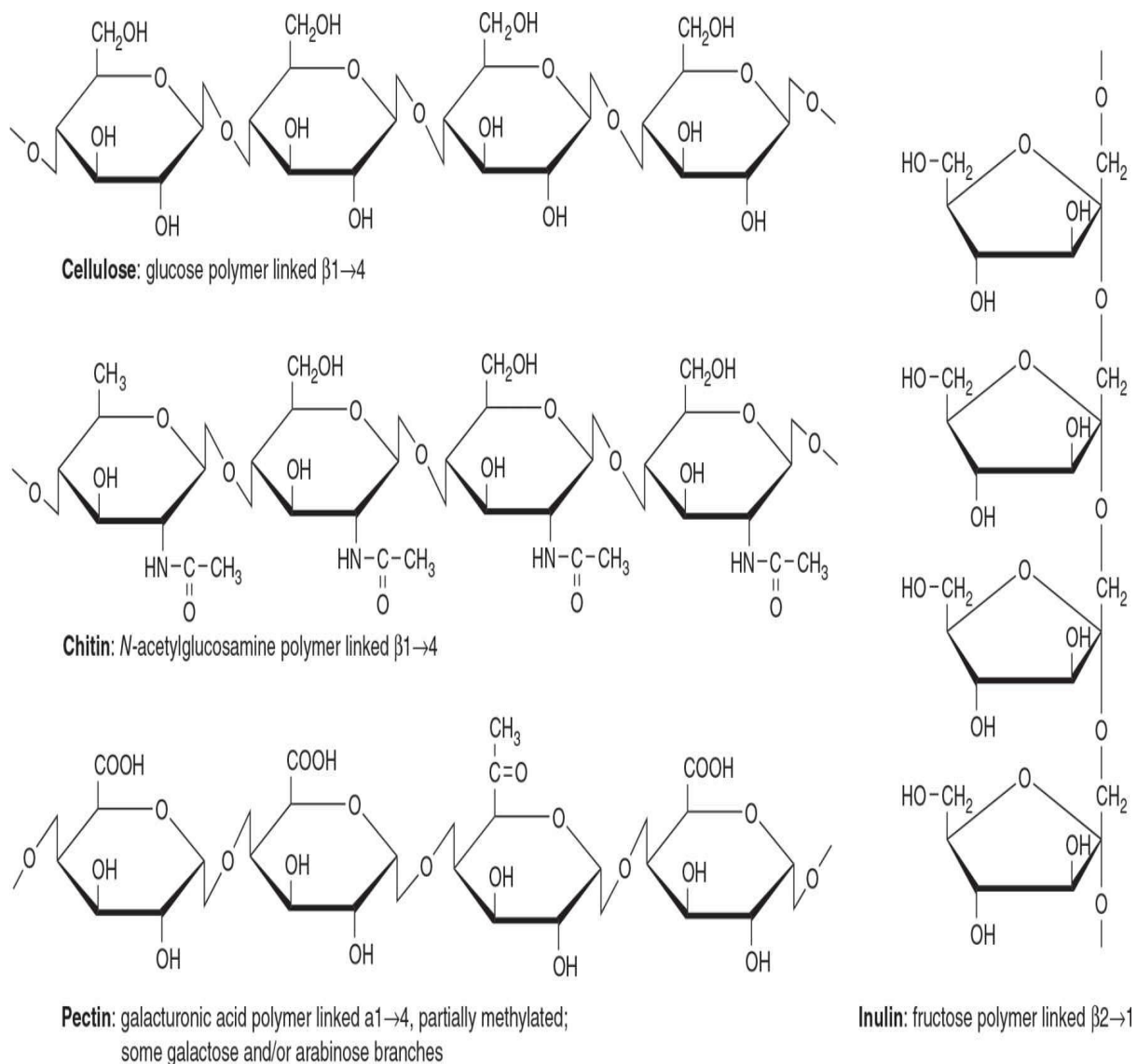

FIGURE 15–13 The structures of some important nonstarch polysaccharides.

Glycosaminoglycans (mucopolysaccharides) are complex carbohydrates containing **amino sugars** and **uronic acids**. They may be attached to a protein molecule to form a **proteoglycan**. Proteoglycans provide the ground or packing substance of connective tissue (see [Chapter 50](#)). They hold large quantities of water and occupy space, thus cushioning or lubricating other structures, because of the large number of —OH groups and negative charges on the molecule, which, by repulsion, keep the carbohydrate chains apart. Examples are **hyaluronic acid**, **chondroitin sulfate**, and **heparin** ([Figure 15–14](#)).

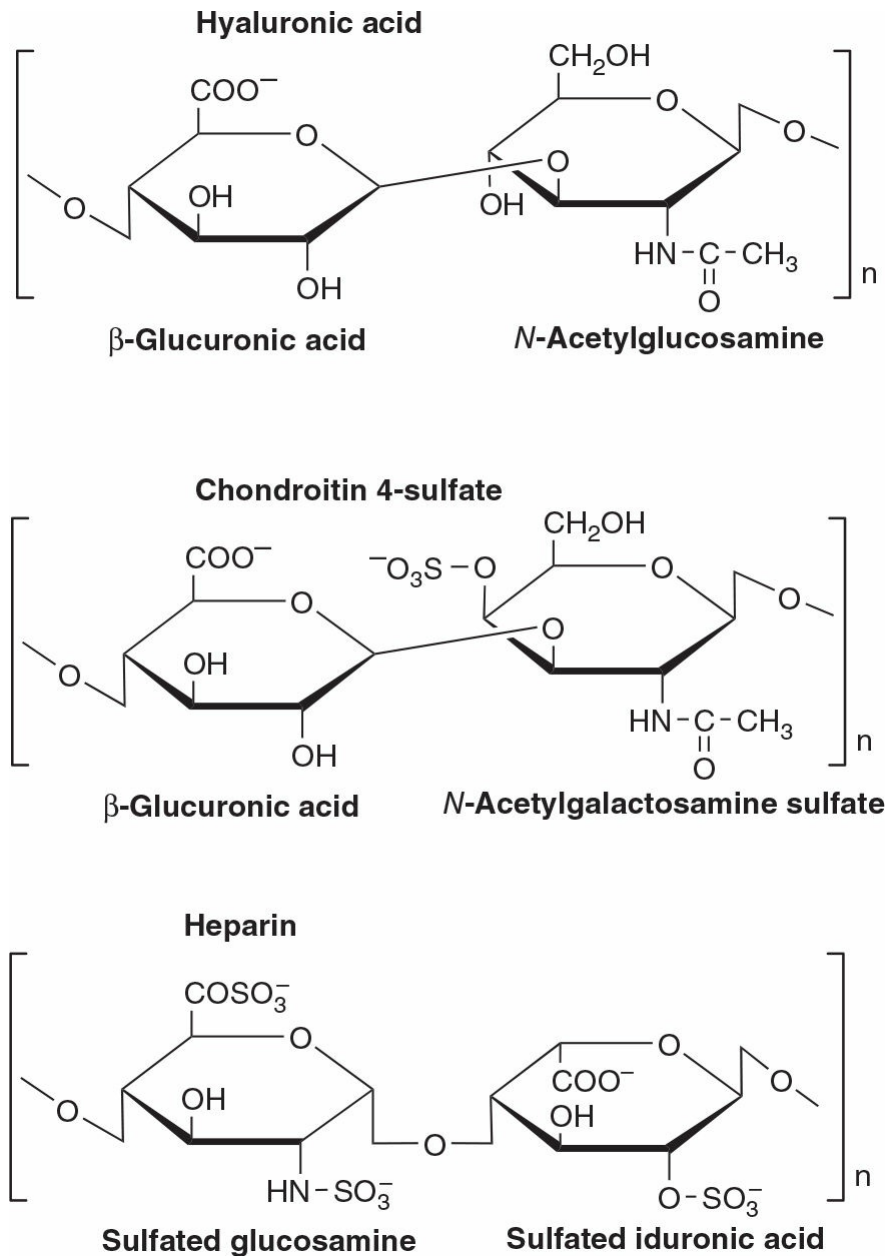
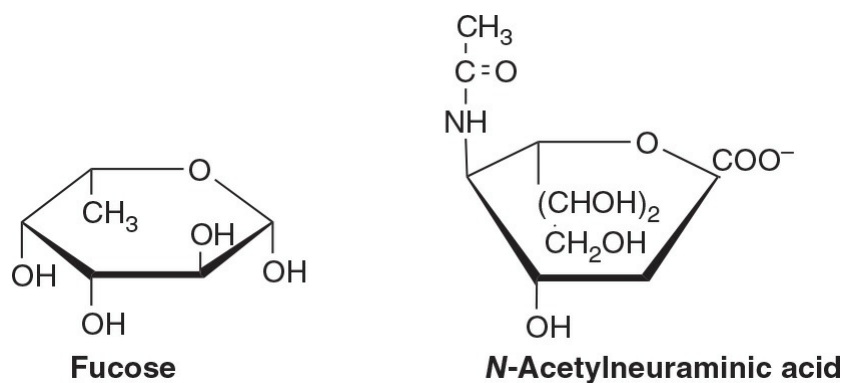

FIGURE 15–14 Structure of some complex polysaccharides and glycosaminoglycans.

Glycoproteins (also known as mucoproteins) are proteins containing branched or unbranched oligosaccharide chains (**Table 15–5**), including **fucose** (**Figure 15–15**). They occur in cell membranes (see **Chapters 40** and **46**) and many proteins are glycosylated. The **sialic acids** are *N*- or *O*-acyl derivatives of neuraminic acid (**Figure 15–15**). **Neuraminic acid** is a nine-carbon sugar derived from mannosamine (an epimer of glucosamine) and pyruvate. Sialic acids are constituents of both **glycoproteins** and **gangliosides**.

TABLE 15–5 Carbohydrates Found in Glycoproteins

Hexoses	Mannose (Man), Galactose (Gal)
Acetyl hexosamines	<i>N</i> -Acetylglucosamine (GlcNAc), <i>N</i> -acetylgalactosamine (GalNAc)
Pentoses	Arabinose (Ara), Xylose (Xyl)
Methyl pentose	L-Fucose (Fuc, see Figure 15–15)
Sialic acids	<i>N</i> -Acyl derivatives of neuraminic acid; the predominant sialic acid is <i>N</i> -acetylneuraminic acid (NeuAc, see Figure 15–15)

**FIGURE 15–15** β -L-Fucose (6-deoxy- β -L-galactose) and *N*-acetylneuraminic acid, a sialic acid.

CARBOHYDRATES OCCUR IN CELL MEMBRANES & IN LIPOPROTEINS

Approximately 5% of the weight of cell membranes is the carbohydrate part of glycoproteins (see [Chapter 46](#)) and glycolipids. Their presence on the outer surface of the plasma membrane (the **glycocalyx**) has been shown with the use of plant **lectins**, proteins that bind specific glycosyl residues. For example, **concanavalin A** binds α -glucosyl and α -mannosyl residues. **Glycophorin** is a major integral membrane glycoprotein of human erythrocytes. It has 130 amino acid residues and spans the lipid membrane, with polypeptide regions outside both the external and internal (cytoplasmic) surfaces. Carbohydrate chains are attached to the amino terminal portion outside the external surface. Carbohydrates are also present in apoprotein B of plasma lipoproteins.

SUMMARY

- The glycome is the entire complement of sugars of an organism, whether free or present in more complex molecules. Glycomics is the study of glycomes, including genetic, physiological, pathological, and other aspects.
- Carbohydrates are major constituents of animal food and animal tissues. They are characterized by the type and number of monosaccharide residues in their molecules.
- Glucose is the most important carbohydrate in mammalian biochemistry because nearly all carbohydrate in food is converted to glucose for metabolism.
- Sugars have large numbers of stereoisomers because they contain several asymmetric carbon atoms.
- The physiologically important monosaccharides include glucose, the “blood sugar,” and ribose, an important constituent of nucleotides and nucleic acids.
- The important disaccharides include maltose (glucosyl-glucose), an intermediate in the digestion of starch; sucrose (glucosyl-fructose), important as a dietary constituent containing fructose; and lactose (galactosyl-glucose), in milk.
- Starch and glycogen are storage polymers of glucose in plants and animals, respectively. Starch is the major metabolic fuel in the diet.
- Complex carbohydrates contain other sugar derivatives such as amino sugars, uronic acids, and sialic acids. They include proteoglycans and glycosaminoglycans, which are associated with structural elements of the tissues, and glycoproteins, which are proteins containing oligosaccharide chains; they are found in many situations including the cell membrane.
- Oligosaccharide chains encode biological information, depending on their constituent sugars and their sequence and linkages.

The Citric Acid Cycle: The Central Pathway of Carbohydrate, Lipid, & Amino Acid Metabolism

David A. Bender, PhD & Peter A. Mayes, PhD, DSc

OBJECTIVES

After studying this chapter, you should be able to:

- Describe the reactions of the citric acid cycle and the reactions that lead to the production of reducing equivalents that are oxidized in the mitochondrial electron transport chain to yield ATP.
- Explain the importance of vitamins in the citric acid cycle.
- Explain how the citric acid cycle provides both a route for catabolism of amino acids and also a route for their synthesis.
- Describe the main anaplerotic pathways that permit replenishment of citric acid cycle intermediates, and how the withdrawal of oxaloacetate for gluconeogenesis is controlled.
- Describe the role of the citric acid cycle in fatty acid synthesis.
- Explain how the activity of the citric acid cycle is controlled by the availability of oxidized cofactors.
- Explain how hyperammonemia can lead to loss of consciousness.

BIOMEDICAL IMPORTANCE

The citric acid cycle (the Krebs or tricarboxylic acid cycle) is a sequence of reactions in mitochondria that oxidizes the acetyl moiety of acetyl-CoA to CO₂ and reduces coenzymes that are reoxidized through the electron transport chain (see [Chapter 13](#)), linked to the formation of ATP.

The citric acid cycle is the final common pathway for the oxidation of carbohydrate, lipid, and protein because glucose, fatty acids, and most amino acids are metabolized to acetyl-CoA or intermediates of the cycle. It also has a central role in gluconeogenesis, lipogenesis, and interconversion of amino acids. Many of these processes occur in most tissues, but liver is the only tissue in which all occur to a significant extent. The repercussions are therefore profound when, for example, large numbers of hepatic cells are damaged as in acute **hepatitis** or replaced by connective tissue (as in **cirrhosis**). The few genetic defects of citric acid cycle enzymes that have been reported are associated with severe neurological damage as a result of very considerably impaired ATP formation in the central nervous system.

Hyperammonemia, as occurs in advanced liver disease, leads to loss of consciousness, coma, and convulsions as a result of impaired activity of the citric acid cycle, leading to reduced formation of ATP. Ammonia both depletes citric acid cycle intermediates (by withdrawing α -ketoglutarate for the formation of glutamate and glutamine) and also inhibits the oxidative decarboxylation of α -ketoglutarate.

THE CITRIC ACID CYCLE PROVIDES SUBSTRATES FOR THE RESPIRATORY CHAIN

The cycle starts with reaction between the acetyl moiety of acetyl-CoA and the four-carbon dicarboxylic acid oxaloacetate, forming a six-carbon tricarboxylic acid, citrate. In the subsequent reactions, two molecules of CO₂ are released and oxaloacetate is regenerated ([Figure 16–1](#)). Only a small quantity of oxaloacetate is needed for the oxidation of a large quantity of acetyl-CoA; it can be considered as playing a **catalytic role**, since it is regenerated at the end of the cycle.

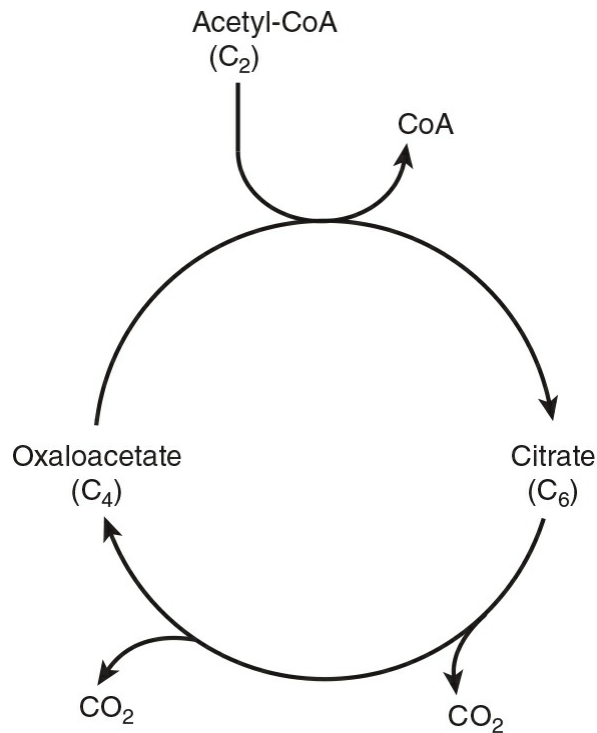

FIGURE 16–1 The citric acid cycle, illustrating the catalytic role of oxaloacetate.

The citric acid cycle provides the main pathway for ATP formation linked to the oxidation of metabolic fuels. During the oxidation of acetyl-CoA, coenzymes are reduced, then reoxidized in the respiratory chain, linked to the formation of ATP (oxidative phosphorylation, [Figure 16–2](#); see also [Chapter 13](#)). This process is **aerobic**, requiring oxygen as the final oxidant of the reduced coenzymes. The enzymes of the citric acid cycle are located in the **mitochondrial matrix**, either free or attached to the inner mitochondrial membrane and the crista membrane, where the enzymes and coenzymes of the respiratory chain are also found (see [Chapter 13](#)).

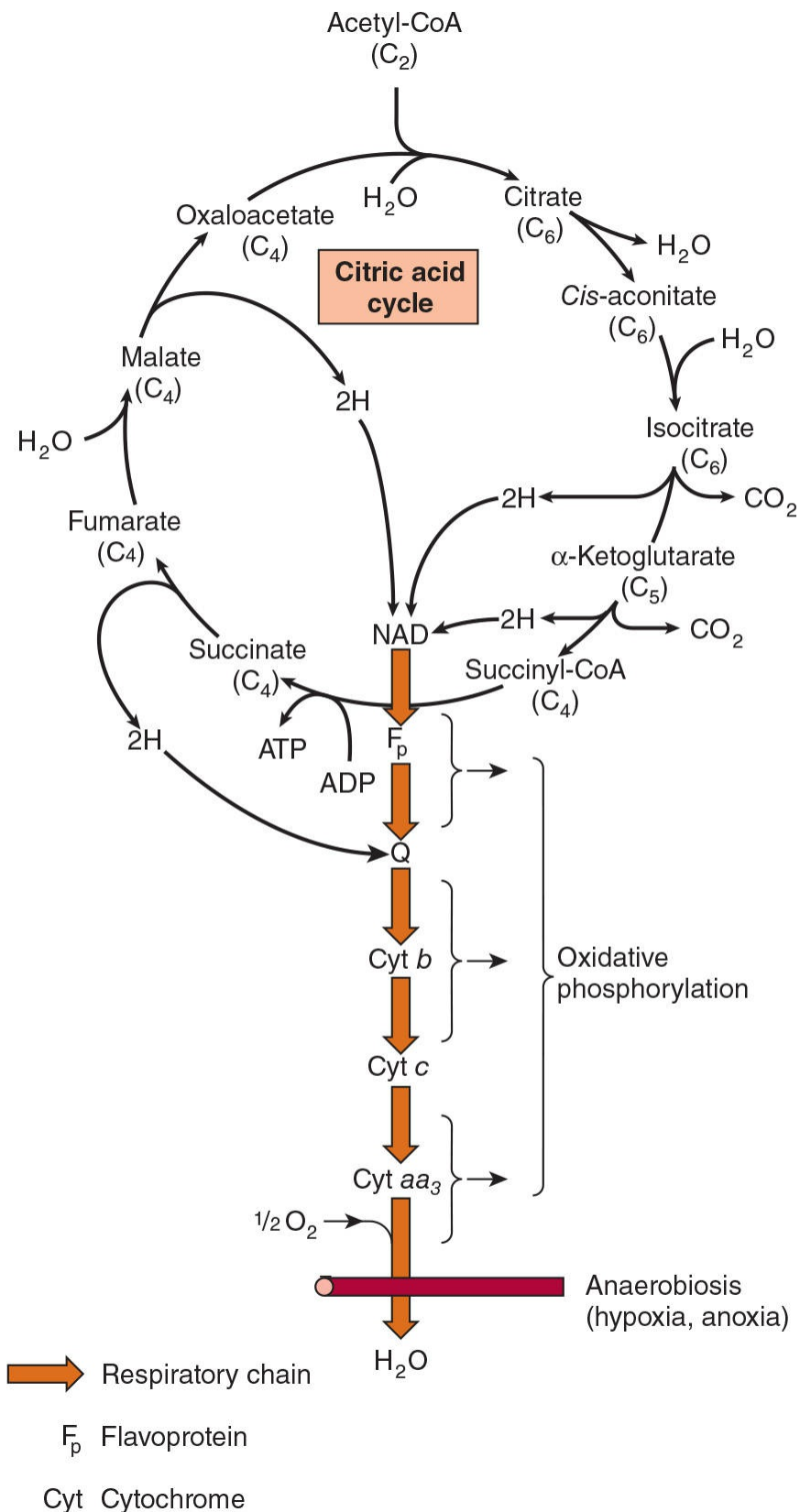

FIGURE 16-2 The citric acid cycle: the major catabolic pathway for acetyl-CoA. Acetyl-CoA, the product of carbohydrate, protein, and lipid catabolism, enters the cycle by forming citrate, and is oxidized to CO₂

with the reduction of coenzymes. Reoxidation of the coenzymes in the respiratory chain leads to phosphorylation of ADP to ATP. For one turn of the cycle, nine ATP are generated via oxidative phosphorylation and one ATP (or GTP) arises at substrate level from the conversion of succinyl-CoA to succinate.

REACTIONS OF THE CITRIC ACID CYCLE PRODUCE REDUCING EQUIVALENTS & CO₂

The initial reaction between acetyl-CoA and oxaloacetate to form citrate is catalyzed by **citrate synthase**, which forms a carbon–carbon bond between the methyl carbon of acetyl-CoA and the carbonyl carbon of oxaloacetate (**Figure 16–3**). The thioester bond of the resultant citryl-CoA is hydrolyzed, releasing citrate and CoASH—an exothermic reaction.

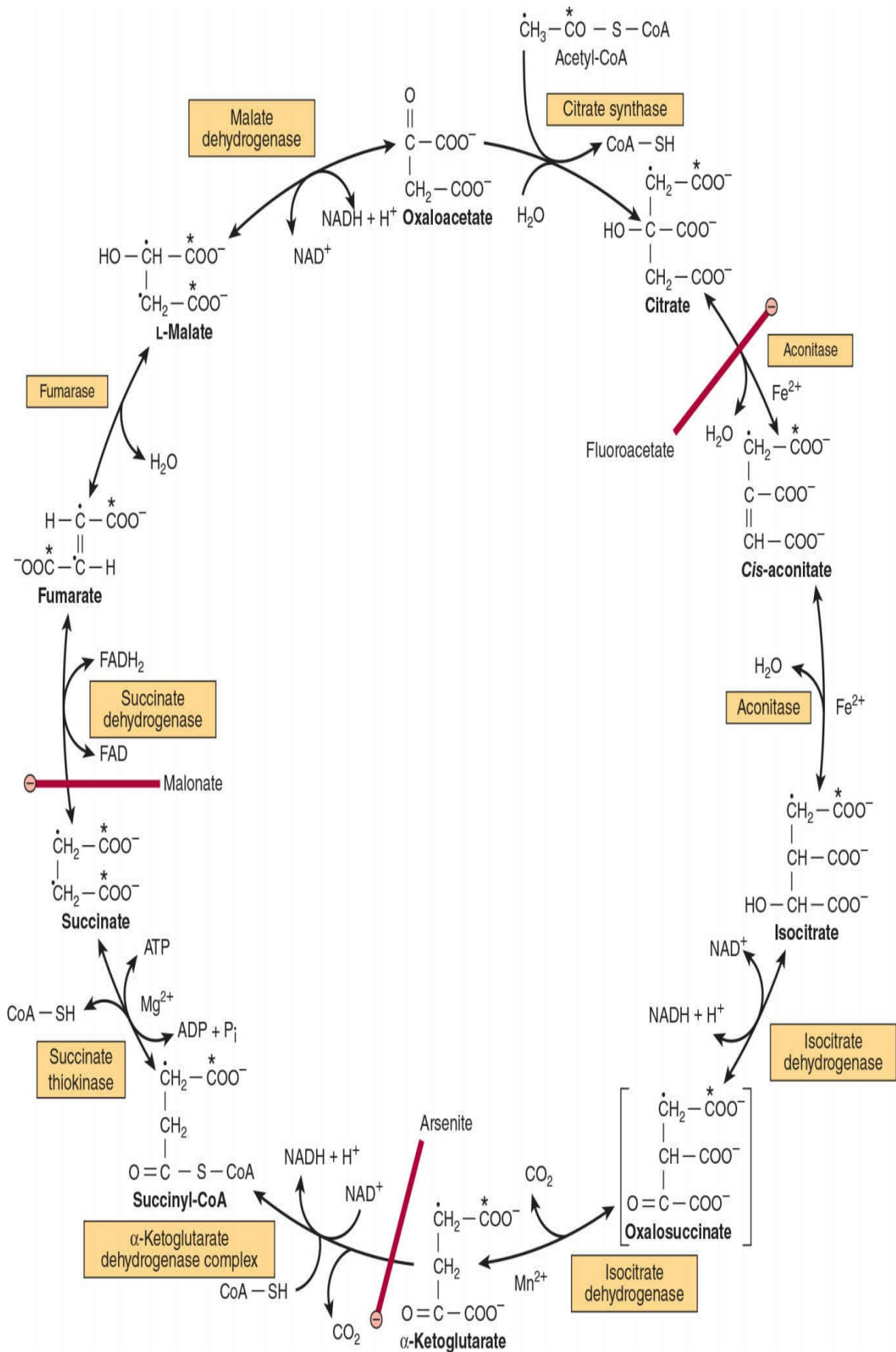

FIGURE 16–3 The citric acid (Krebs) cycle. Oxidation of NADH and FADH₂ in the respiratory chain leads to the formation of ATP via oxidative phosphorylation. In order to follow the passage of acetyl-CoA through the cycle, the two carbon atoms of the acetyl moiety are shown labeled on the carboxyl carbon (*) and on the methyl carbon (•). Although two carbon atoms are lost as CO₂ in one turn of the cycle, these atoms are not derived from the acetyl-CoA that has immediately entered the cycle, but from that portion of the citrate molecule that was derived from oxaloacetate. However, on completion of a single turn of the cycle, the oxaloacetate that is regenerated is now labeled, which leads to labeled CO₂ being evolved during the second turn of the cycle. Because succinate is a symmetrical compound, “randomization” of label occurs at this step so that all four carbon atoms of oxaloacetate appear to be labeled after one turn of the cycle. During gluconeogenesis, some of the label in oxaloacetate is incorporated into glucose and glycogen (see [Figure 20–1](#)). The sites of inhibition (⊖) by fluoroacetate, malonate, and arsenite are indicated.

Citrate is isomerized to isocitrate by the enzyme **aconitase** (aconitate hydratase); the reaction occurs in two steps: dehydration to *cis*-aconitate and rehydration to isocitrate. Although citrate is a symmetrical molecule, aconitase reacts with citrate asymmetrically, so that the two carbon atoms that are lost in subsequent reactions of the cycle are not those that were added from acetyl-CoA. This asymmetric behavior is the result of **channeling**—transfer of the product of citrate synthase directly onto the active site of aconitase, without entering free solution. This provides integration of citric acid cycle activity with the provision of citrate in the cytosol as a source of acetyl-CoA for fatty acid synthesis. Citrate is only available in free solution to be transported from the mitochondria to the cytosol for fatty acid synthesis when aconitase is inhibited by accumulation of its product, isocitrate.

The poison **fluoroacetate** is found in some of the plants, and their consumption can be fatal to grazing animals. Some fluorinated compounds used as anticancer agents and industrial chemicals (including pesticides) are metabolized to fluoroacetate. It is toxic because fluoroacetyl-CoA condenses with oxaloacetate to form fluorocitrate, which inhibits aconitase, causing citrate to accumulate.

Isocitrate undergoes dehydrogenation catalyzed by **isocitrate dehydrogenase** to form, initially, oxalosuccinate, which remains enzyme

bound and undergoes decarboxylation to α -ketoglutarate. The decarboxylation requires Mg^{2+} or Mn^{2+} ions. There are three isoenzymes of isocitrate dehydrogenase. One, which uses nicotinamide adenine dinucleotide (NAD^+), is found only in mitochondria. The other two use $NADP^+$ and are found in mitochondria and the cytosol. Respiratory chain-linked oxidation of isocitrate occurs through the NAD^+ -dependent enzyme.

α -Ketoglutarate undergoes **oxidative decarboxylation** in a reaction catalyzed by a multienzyme complex similar to that involved in the oxidative decarboxylation of pyruvate (see [Figure 17-5](#)). The **α -ketoglutarate dehydrogenase complex** requires the same cofactors as the pyruvate dehydrogenase complex—thiamin diphosphate, lipoate, NAD^+ , flavin adenine dinucleotide (FAD), and CoA—and results in the formation of succinyl-CoA. The equilibrium of this reaction is so much in favor of succinyl-CoA formation that it must be considered to be physiologically unidirectional. As in the case of pyruvate oxidation (see [Chapter 17](#)), arsenite inhibits the reaction, causing the substrate, **α -ketoglutarate**, to accumulate. High concentrations of ammonia inhibit α -ketoglutarate dehydrogenase.

Succinyl-CoA is converted to succinate by the enzyme **succinate thiokinase (succinyl-CoA synthetase)**. This is the only example of substrate-level phosphorylation in the citric acid cycle. Tissues in which gluconeogenesis occurs (the liver and kidney) contain two isoenzymes of succinate thiokinase, one specific for GDP and the other for ADP. The GTP formed is used for the decarboxylation of oxaloacetate to phosphoenolpyruvate in gluconeogenesis, and provides a regulatory link between citric acid cycle activity and the withdrawal of oxaloacetate for gluconeogenesis. Nongluconeogenic tissues have only the isoenzyme that phosphorylates ADP.

When ketone bodies are being metabolized in extrahepatic tissues, there is an alternative reaction catalyzed by **succinyl-CoA-acetoacetate-CoA transferase (thiophorase)**, involving transfer of CoA from succinyl-CoA to acetoacetate, forming acetoacetyl-CoA and succinate (see [Chapter 22](#)).

The onward metabolism of succinate, leading to the regeneration of oxaloacetate, is the same sequence of chemical reactions as occurs in the β -oxidation of fatty acids: dehydrogenation to form a carbon-carbon double bond, addition of water to form a hydroxyl group, and a further dehydrogenation to yield the oxo-group of oxaloacetate.

The first dehydrogenation reaction, forming fumarate, is catalyzed by

succinate dehydrogenase, which is bound to the inner surface of the inner mitochondrial membrane. The enzyme contains FAD and iron-sulfur (Fe-S) protein, and directly reduces ubiquinone in the electron transport chain. **Fumarase (fumarate hydratase)** catalyzes the addition of water across the double bond of fumarate, yielding malate. Malate is oxidized to oxaloacetate by **malate dehydrogenase**, linked to the reduction of NAD^+ . Although the equilibrium of this reaction strongly favors malate, the net flux is to oxaloacetate because of the continual removal of oxaloacetate (to form citrate, as a substrate for gluconeogenesis, or to undergo transamination to aspartate) and also the continual reoxidation of NADH.

TEN ATP ARE FORMED PER TURN OF THE CITRIC ACID CYCLE

As a result of oxidations catalyzed by the dehydrogenases of the citric acid cycle, three molecules of NADH and one of FADH_2 are produced for each molecule of acetyl-CoA catabolized in one turn of the cycle. These reducing equivalents are transferred to the respiratory chain (see [Figure 13-3](#)), where reoxidation of each NADH results in formation of ~ 2.5 ATP, and of FADH_2 , ~ 1.5 ATP. In addition, 1 ATP (or GTP) is formed by substrate-level phosphorylation catalyzed by succinate thiokinase.

VITAMINS PLAY KEY ROLES IN THE CITRIC ACID CYCLE

Four of the B vitamins (see [Chapter 44](#)) are essential in the citric acid cycle and hence energy-yielding metabolism: **riboflavin**, as FAD, is the cofactor for succinate dehydrogenase; **niacin**, as NAD^+ , is the electron acceptor for isocitrate dehydrogenase, α -ketoglutarate dehydrogenase, and malate dehydrogenase; thiamin (**vitamin B1**), as thiamin diphosphate, is the coenzyme for decarboxylation in the α -ketoglutarate dehydrogenase reaction; and **pantothenic acid**, as part of coenzyme A, is esterified to carboxylic acids to form acetyl-CoA and succinyl-CoA.

THE CITRIC ACID CYCLE PLAYS A PIVOTAL ROLE IN METABOLISM

The citric acid cycle is not only a pathway for oxidation of two carbon units, but is also a major pathway for interconversion of metabolites

arising from **transamination** and **deamination** of amino acids (see [Chapters 28](#) and [29](#)), and providing the substrates for **amino acid synthesis** by transamination (see [Chapter 27](#)), as well as for **gluconeogenesis** (see [Chapter 19](#)) and **fatty acid synthesis** (see [Chapter 23](#)). Because it functions in both oxidative and synthetic processes, it is **amphibolic** ([Figure 16–4](#)).

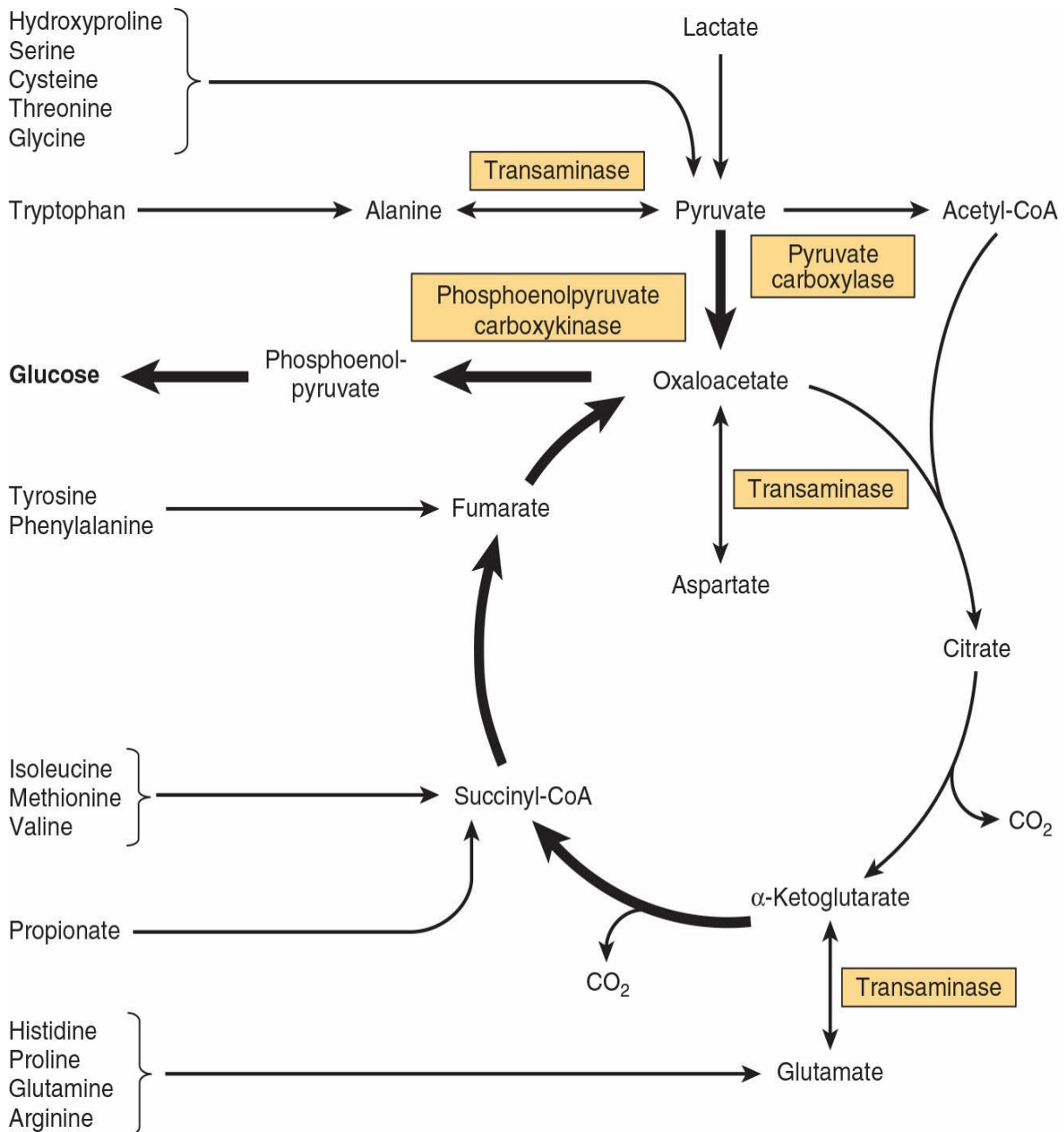

FIGURE 16–4 Involvement of the citric acid cycle in transamination and gluconeogenesis. The bold arrows indicate the main pathway of gluconeogenesis.

The Citric Acid Cycle Takes Part in Gluconeogenesis, Transamination, & Deamination

All the intermediates of the cycle are potentially **glucogenic**, since they can give rise to oxaloacetate, and hence production of glucose (in the liver and kidney, which carry out gluconeogenesis; see [Chapter 19](#)). The key enzyme that catalyzes transfer out of the cycle into gluconeogenesis is **phosphoenolpyruvate carboxykinase**, which catalyzes the decarboxylation of oxaloacetate to phosphoenolpyruvate, with GTP acting as the phosphate donor (see [Figure 19–1](#)). The GTP required for this reaction is provided by the GDP-dependent isoenzyme of succinate thiokinase. This ensures that oxaloacetate will not be withdrawn from the cycle for gluconeogenesis if this would lead to depletion of citric acid cycle intermediates, and hence reduced generation of ATP.

Net transfer into the cycle occurs as a result of several reactions. Among the most important of such **anaplerotic** reactions is the formation of oxaloacetate by the carboxylation of pyruvate, catalyzed by **pyruvate carboxylase** ([Figure 16–4](#)). This reaction is important in maintaining an adequate concentration of oxaloacetate for the condensation reaction with acetyl-CoA. If acetyl-CoA accumulates, it acts as both an allosteric activator of pyruvate carboxylase and an inhibitor of pyruvate dehydrogenase, thereby ensuring a supply of oxaloacetate. Lactate, an important substrate for gluconeogenesis, enters the cycle via oxidation to pyruvate and then carboxylation to oxaloacetate. **Glutamate** and **glutamine** are important anaplerotic substrates because they yield α -ketoglutarate as a result of the reactions catalyzed by glutaminase and glutamate dehydrogenase. Transamination of **aspartate** leads directly to the formation of oxaloacetate, and a variety of compounds that are metabolized to yield **propionyl CoA**, which can be carboxylated and isomerized to succinyl CoA, are also important anaplerotic substrates.

Aminotransferase (transaminase) reactions form pyruvate from alanine, oxaloacetate from aspartate, and α -ketoglutarate from glutamate. Because these reactions are reversible, the cycle also serves as a source of carbon skeletons for the synthesis of these amino acids. Other amino acids contribute to gluconeogenesis because their carbon skeletons give rise to citric acid cycle intermediates. Alanine, cysteine, glycine, hydroxyproline, serine, threonine, and tryptophan yield pyruvate; arginine, histidine, glutamine, and proline yield α -ketoglutarate; isoleucine, methionine, and valine yield succinyl-CoA; tyrosine and phenylalanine yield fumarate ([Figure 16–4](#)).

The citric acid cycle itself does not provide a pathway for the complete oxidation of the carbon skeletons of amino acids that give rise to intermediates such as α -ketoglutarate, succinyl CoA, fumarate, and oxaloacetate, because this results in an increase in the amount of oxaloacetate. For complete oxidation to occur, oxaloacetate must undergo phosphorylation and carboxylation to phosphoenolpyruvate (at the expense of GTP), then dephosphorylation to pyruvate (catalyzed by pyruvate kinase), and oxidative decarboxylation to acetyl-Co (catalyzed by pyruvate dehydrogenase).

In ruminants, whose main metabolic fuel is short-chain fatty acids formed by bacterial fermentation, the conversion of propionate, the major glucogenic product of rumen fermentation, to succinyl-CoA via the methylmalonyl-CoA pathway (see [Figure 19–2](#)) is especially important.

The Citric Acid Cycle Takes Part in Fatty Acid Synthesis

Acetyl-CoA, formed from pyruvate by the action of pyruvate dehydrogenase, is the major substrate for long-chain fatty acid synthesis in nonruminants ([Figure 16–5](#)). (In ruminants, acetyl-CoA is derived directly from acetate.) Pyruvate dehydrogenase is a mitochondrial enzyme, and fatty acid synthesis is a cytosolic pathway; the mitochondrial membrane is impermeable to acetyl-CoA. For acetyl-CoA to be available in the cytosol, citrate is transported from the mitochondrion to the cytosol, then cleaved in a reaction catalyzed by **citrate lyase** ([Figure 16–5](#)). Citrate is only available for transport out of the mitochondrion when aconitase is inhibited by its product and therefore saturated with its substrate, so that citrate cannot be channeled directly from citrate synthase onto aconitase. This ensures that citrate is used for fatty acid synthesis only when there is an adequate amount to ensure continued activity of the cycle.

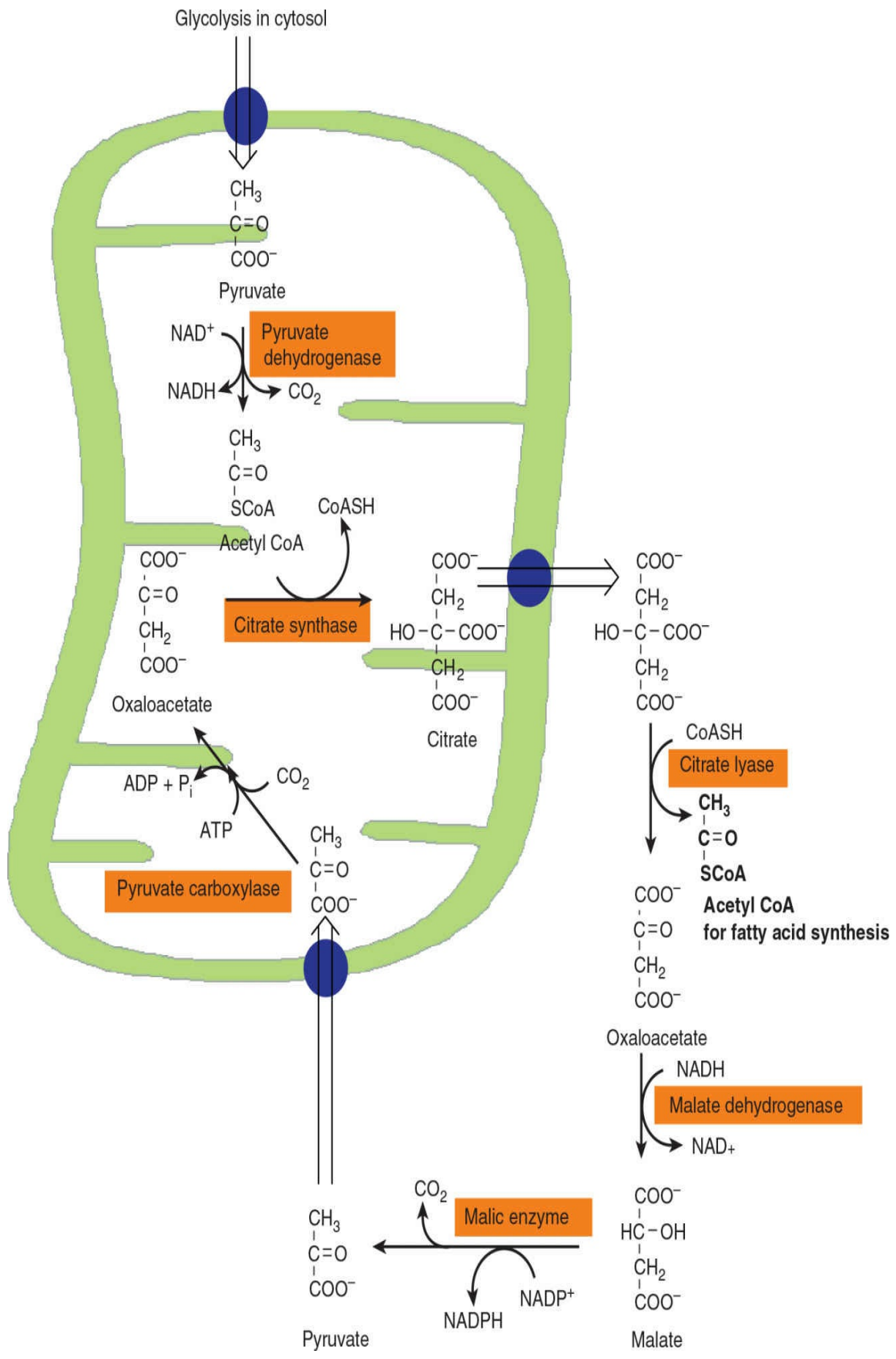

FIGURE 16–5 Participation of the citric acid cycle in provision of cytosolic acetyl-CoA for fatty acid synthesis from glucose. See also Figure 23–5.

The oxaloacetate released by citrate lyase cannot reenter the mitochondrion, but is reduced to malate, at the expense of NADH, and the malate undergoes oxidative decarboxylation to pyruvate, reducing NADP⁺ to NADPH. This reaction, catalyzed by the malic enzyme, is the source of half the NADPH required for fatty acid synthesis (the remainder is provided by the pentose phosphate pathway, see Chapter 20). Pyruvate enters the mitochondrion and is carboxylated to oxaloacetate by pyruvate carboxylase, an ATP-dependent reaction in which the coenzyme is the vitamin biotin.

Regulation of the Citric Acid Cycle Depends Primarily on a Supply of Oxidized Cofactors

In most tissues, where the primary role of the citric acid cycle is in energy-yielding metabolism, **respiratory control** via the respiratory chain and oxidative phosphorylation regulates citric acid cycle activity (see Chapter 13). Thus, activity is immediately dependent on the supply of NAD⁺, which in turn, because of the tight coupling between oxidation and phosphorylation, is dependent on the availability of ADP and hence, ultimately on the utilization of ATP in chemical and physical work. In addition, individual enzymes of the cycle are regulated. The main sites for regulation are the nonequilibrium reactions catalyzed by pyruvate dehydrogenase, citrate synthase, isocitrate dehydrogenase, and α -ketoglutarate dehydrogenase. The dehydrogenases are activated by Ca²⁺, which increases in concentration during contraction of muscle and during secretion by other tissues, when there is increased energy demand. In a tissue such as brain, which is largely dependent on carbohydrate to supply acetyl-CoA, control of the citric acid cycle may occur at pyruvate dehydrogenase. Several enzymes are responsive to the energy status as shown by the [ATP]/[ADP] and [NADH]/[NAD⁺] ratios. Thus, there is allosteric inhibition of citrate synthase by ATP and long-chain fatty acyl-CoA. Allosteric activation of mitochondrial NAD-dependent isocitrate dehydrogenase by ADP is counteracted by ATP and NADH. The α -ketoglutarate dehydrogenase complex is regulated in the same way as is pyruvate dehydrogenase (see Figure 17–6). Succinate dehydrogenase is

inhibited by oxaloacetate, and the availability of oxaloacetate is controlled by malate dehydrogenase and depends on the $[NADH]/[NAD^+]$ ratio. Since the K_m of citrate synthase for oxaloacetate is of the same order of magnitude as the intramitochondrial concentration, it is likely that the concentration of oxaloacetate controls the rate of citrate formation.

Hyperammonemia, as occurs in advanced liver disease and a number of (rare) genetic diseases of amino acid metabolism, leads to loss of consciousness, coma and convulsions, and may be fatal. This is largely because of the withdrawal of α -ketoglutarate to form glutamate (catalyzed by glutamate dehydrogenase) and then glutamine (catalyzed by glutamine synthetase), leading to lowered concentrations of all citric acid cycle intermediates, and hence reduced generation of ATP. The equilibrium of glutamate dehydrogenase is finely poised, and the direction of reaction depends on the ratio of $NAD^+ : NADH$ and the concentration of ammonium ions. In addition, ammonia inhibits α -ketoglutarate dehydrogenase, and possibly also pyruvate dehydrogenase.

SUMMARY

- The citric acid cycle is the final pathway for the oxidation of carbohydrate, lipid, and protein. Their common end-metabolite, acetyl-CoA, reacts with oxaloacetate to form citrate. By a series of dehydrogenations and decarboxylations, citrate is degraded, reducing coenzymes, releasing two CO_2 , and regenerating oxaloacetate.
- The reduced coenzymes are oxidized by the respiratory chain linked to formation of ATP. Thus, the cycle is the major pathway for the formation of ATP and is located in the matrix of mitochondria adjacent to the enzymes of the respiratory chain and oxidative phosphorylation.
- The citric acid cycle is amphibolic, since in addition to oxidation it is important in the provision of carbon skeletons for gluconeogenesis, acetyl-CoA for fatty acid synthesis, and interconversion of amino acids.

Glycolysis & the Oxidation of Pyruvate

David A. Bender, PhD & Peter A. Mayes, PhD, DSc

OBJECTIVES

After studying this chapter, you should be able to:

- Describe the pathway of glycolysis and its control, and explain how glycolysis can operate under anaerobic conditions.
- Describe the reaction of pyruvate dehydrogenase and its regulation.
- Explain how inhibition of pyruvate metabolism leads to lactic acidosis.

BIOMEDICAL IMPORTANCE

Most tissues have at least some requirement for glucose; in the brain, the requirement is substantial—even in prolonged fasting the brain can meet no more than about 20% of its energy needs from ketone bodies.

Glycolysis is the main pathway of glucose (and other carbohydrate) metabolism. It occurs in the cytosol of all cells, and can function either

aerobically or anaerobically, depending on the availability of oxygen and the electron transport chain (and hence of the presence of mitochondria). Erythrocytes, which lack mitochondria, are completely reliant on glucose as their metabolic fuel, and metabolize it by anaerobic glycolysis.

The ability of glycolysis to provide ATP in the absence of oxygen allows skeletal muscle to perform at very high levels of work output when oxygen supply is insufficient, and it allows tissues to survive anoxic episodes. However, heart muscle, which is adapted for aerobic performance, has relatively low glycolytic activity and poor survival under conditions of **ischemia**. Diseases in which enzymes of glycolysis (eg, pyruvate kinase) are deficient are mainly seen as **hemolytic anemias** or, if the defect affects skeletal muscle (eg, phosphofructokinase), as **fatigue**. In fast-growing cancer cells, glycolysis proceeds at a high rate, forming large amounts of pyruvate, which is reduced to lactate and exported. This produces a relatively acidic local environment in the tumor. The lactate is used for gluconeogenesis in the liver (see [Chapter 19](#)), an energy-expensive process, which is responsible for much of the **hypermetabolism** seen in **cancer cachexia**. **Lactic acidosis** results from various causes, including impaired activity of pyruvate dehydrogenase, especially in thiamin (vitamin B₁) deficiency.

GLYCOLYSIS CAN FUNCTION UNDER ANAEROBIC CONDITIONS

Early in the investigations of glycolysis, it was realized that fermentation in yeast was similar to the breakdown of glycogen in muscle. When a muscle contracts under anaerobic conditions, **glycogen disappears** and **lactate appears**. When oxygen is admitted, aerobic recovery takes place and lactate is no longer produced. If muscle contraction occurs under aerobic conditions, lactate does not accumulate and pyruvate is the end product of glycolysis. Pyruvate is oxidized further to CO₂ and water ([Figure 17-1](#)). When oxygen is in short supply, mitochondrial reoxidation of NADH formed during glycolysis is impaired, and NADH is reoxidized by reducing pyruvate to lactate, so permitting glycolysis to continue. While glycolysis can occur under anaerobic conditions, this has a price, for it limits the amount of ATP formed per mole of glucose oxidized, so that much more glucose must be metabolized under anaerobic than aerobic conditions ([Table 17-1](#)). In yeast and some other microorganisms, pyruvate formed in anaerobic glycolysis is not reduced to lactate, but is

decarboxylated and reduced to ethanol.

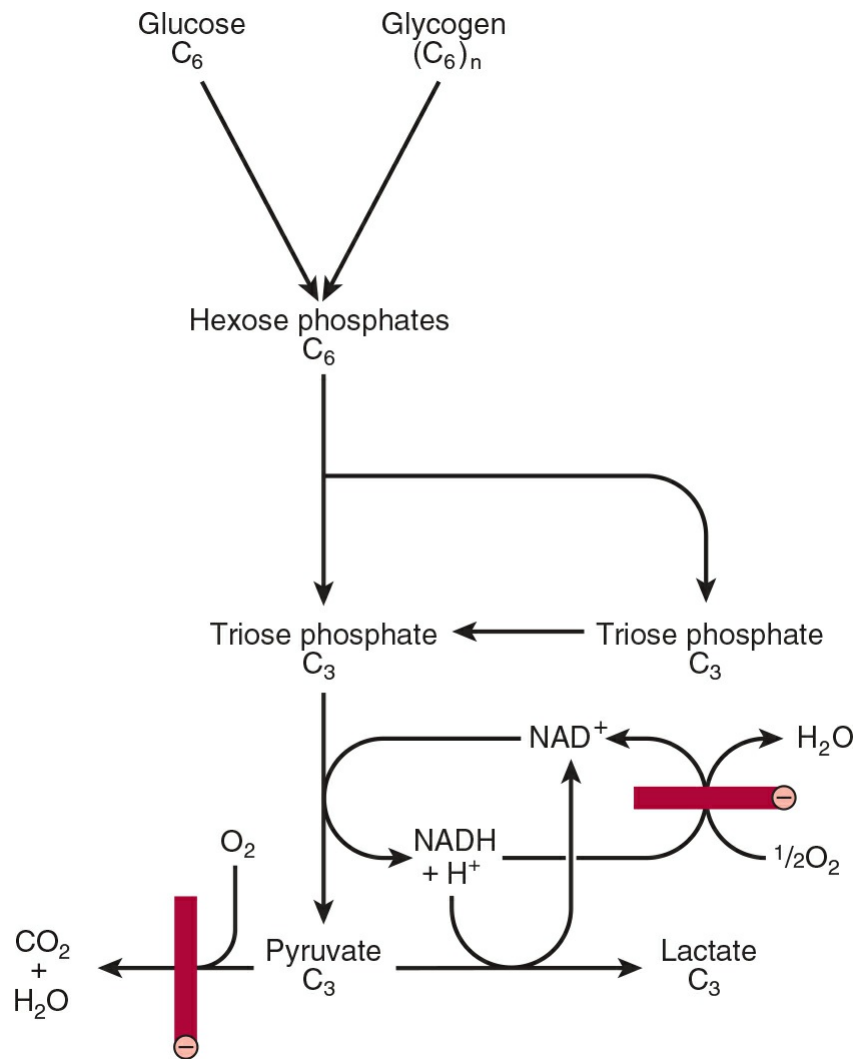

FIGURE 17-1 Summary of glycolysis. ⊖, blocked under anaerobic conditions or by absence of mitochondria containing key respiratory enzymes, as in erythrocytes.

TABLE 17-1 ATP Formation in the Catabolism of Glucose

Pathway	Reaction Catalyzed by	Method of ATP Formation	ATP per mol of Glucose
Glycolysis	Glyceraldehyde-3-phosphate dehydrogenase	Respiratory chain oxidation of 2 NADH	5 ^a
	Phosphoglycerate kinase	Substrate-level phosphorylation	2
	Pyruvate kinase	Substrate-level phosphorylation	2
			9
	Consumption of ATP for reactions of hexokinase and phosphofructokinase		-2
		Net 7	
Citric acid cycle	Pyruvate dehydrogenase	Respiratory chain oxidation of 2 NADH	5
	Isocitrate dehydrogenase	Respiratory chain oxidation of 2 NADH	5
	α -Ketoglutarate dehydrogenase	Respiratory chain oxidation of 2 NADH	5
	Succinate thiokinase	Substrate-level phosphorylation	2
	Succinate dehydrogenase	Respiratory chain oxidation of 2 FADH ₂	3
	Malate dehydrogenase	Respiratory chain oxidation of 2 NADH	5
			Net 25
	Total per mol of glucose under aerobic conditions		32
	Total per mol of glucose under anaerobic conditions		2

^aThis assumes that NADH formed in glycolysis is transported into mitochondria by the malate shuttle (see Figure 13-13). If the glycerophosphate shuttle is used, then only 1.5 ATP will be formed per mol of NADH. There is a considerable advantage in using glycogen rather than glucose for anaerobic glycolysis in muscle, since the product of glycogen phosphorylase is glucose-1-phosphate (see Figure 18-1), which is interconvertible with glucose-6-phosphate. This saves the ATP that would otherwise be used by hexokinase, increasing the net yield of ATP from 2 to 3 per glucose.

THE REACTIONS OF GLYCOLYSIS CONSTITUTE THE MAIN PATHWAY OF GLUCOSE UTILIZATION

The overall equation for glycolysis from glucose to lactate is as follows:

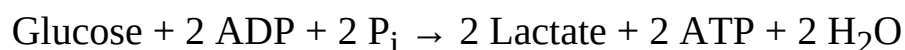

All of the enzymes of glycolysis (**Figure 17-2**) are cytosolic. Glucose enters glycolysis by phosphorylation to glucose-6-phosphate, catalyzed by **hexokinase**, using ATP as the phosphate donor. Under physiological conditions, the phosphorylation of glucose to glucose-6-phosphate can be

regarded as irreversible. Hexokinase is inhibited allosterically by its product, glucose-6-phosphate.

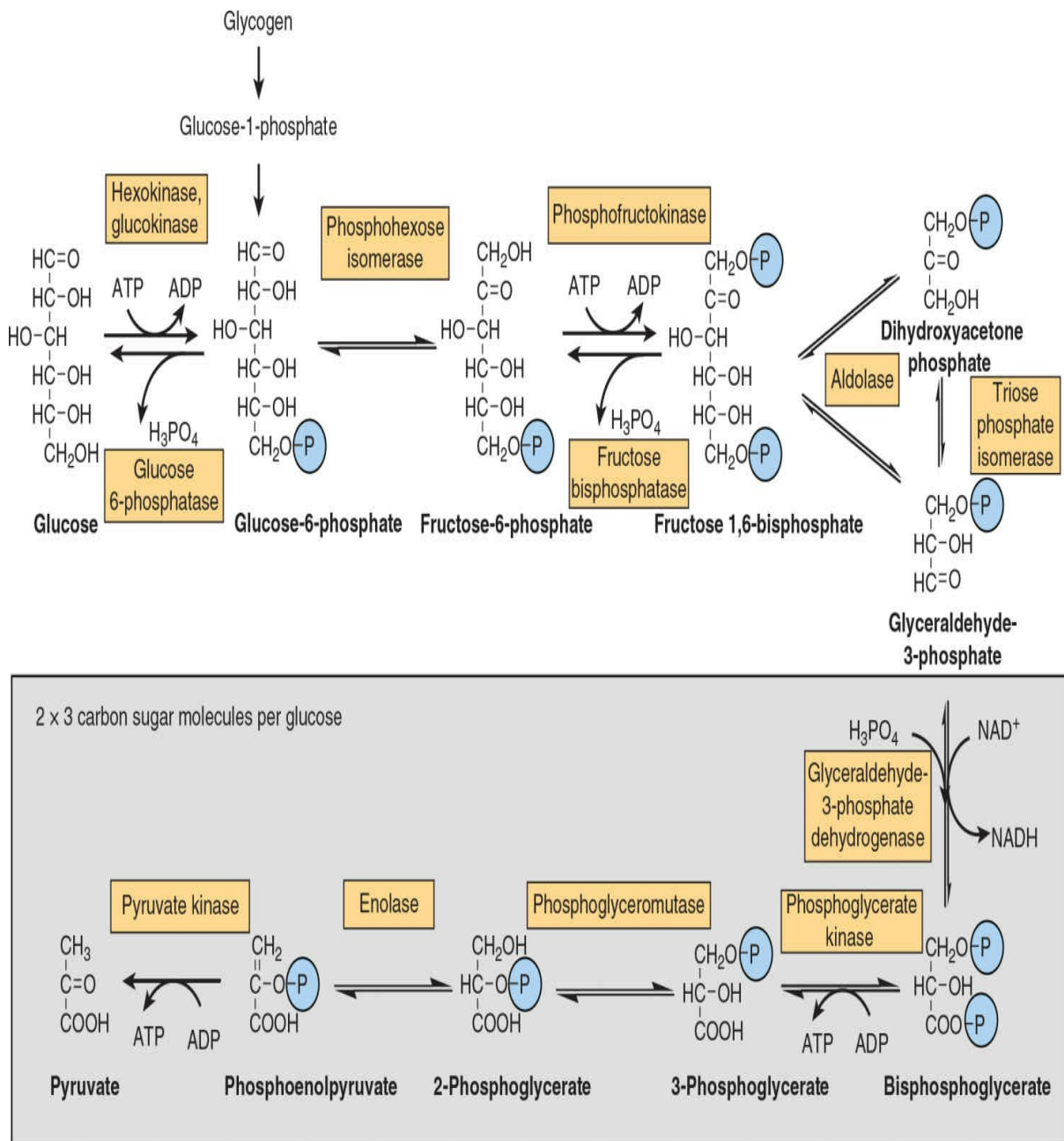

FIGURE 17-2 The pathway of glycolysis. (⊖, —PO₃²⁻; P_i, HOPO₃²⁻; ⊕, inhibition.) Carbons 1–3 of fructose bisphosphate form dihydroxyacetone phosphate, and carbons 4–6 form glyceraldehyde-3-phosphate.

In tissues other than the liver (and pancreatic β -islet cells), the availability of glucose for glycolysis (or glycogen synthesis in muscle, [Chapter 18](#), and lipogenesis in adipose tissue, [Chapter 23](#)) is controlled by

transport into the cell, which in turn is regulated by **insulin**. Hexokinase has a high affinity (low K_m) for glucose, and in the liver, it is saturated under normal conditions, and so acts at a constant rate to provide glucose-6-phosphate to meet the liver's needs. Liver cells also contain an isoenzyme of hexokinase, **glucokinase**, which has a K_m very much higher than the normal intracellular concentration of glucose. The function of glucokinase in the liver is to remove glucose from the hepatic portal blood following a meal, so regulating the concentration of glucose available to peripheral tissues. This provides more glucose-6-phosphate than is required for glycolysis; it is used for glycogen synthesis and lipogenesis. Glucokinase is also found in pancreatic β -islet cells, where it functions to detect high concentrations of glucose in the portal blood. As more glucose is phosphorylated by glucokinase, there is increased glycolysis, leading to increased formation of ATP. This leads to closure of an ATP-potassium channel, causing membrane depolarization and opening of a voltage-gated calcium channel. The resultant influx of calcium ions leads to fusion of the insulin secretory granules with the cell membrane and the release of insulin.

Glucose-6-phosphate is an important compound at the junction of several metabolic pathways: glycolysis, gluconeogenesis (see [Chapter 19](#)), the pentose phosphate pathway (see [Chapter 20](#)), glycogenesis, and glycogenolysis (see [Chapter 18](#)). In glycolysis, it is converted to fructose-6-phosphate by **phosphohexose isomerase**, which involves an aldose–ketose isomerization. This reaction is followed by another phosphorylation catalyzed by the enzyme **phosphofructokinase** (phosphofructokinase-1) forming fructose 1,6-bisphosphate. The phosphofructokinase reaction is irreversible under physiological conditions. Phosphofructokinase is both inducible and subject to allosteric regulation, and has a major role in regulating the rate of glycolysis. Fructose 1,6-bisphosphate is cleaved by **aldolase** (fructose 1,6-bisphosphate aldolase) into two triose phosphates, glyceraldehyde-3-phosphate and dihydroxyacetone phosphate, which are interconverted by the enzyme **phosphotriose isomerase**.

Glycolysis continues with the oxidation of glyceraldehyde-3-phosphate to 1,3-bisphosphoglycerate. The enzyme catalyzing this oxidation, **glyceraldehyde-3-phosphate dehydrogenase**, is NAD dependent. Structurally, it consists of four identical polypeptides (monomers) forming a tetramer. Four —SH groups are present on each polypeptide, derived from cysteine residues within the polypeptide chain. One of the —SH groups is found at the active site of the enzyme ([Figure 17–3](#)). The

substrate initially combines with this —SH group, forming a thiohemiacetal that is oxidized to a thiol ester; the hydrogens removed in this oxidation are transferred to NAD^+ . The thiol ester then undergoes phosphorolysis; inorganic phosphate (P_i) is added, forming 1,3-bisphosphoglycerate, and the free —SH group.

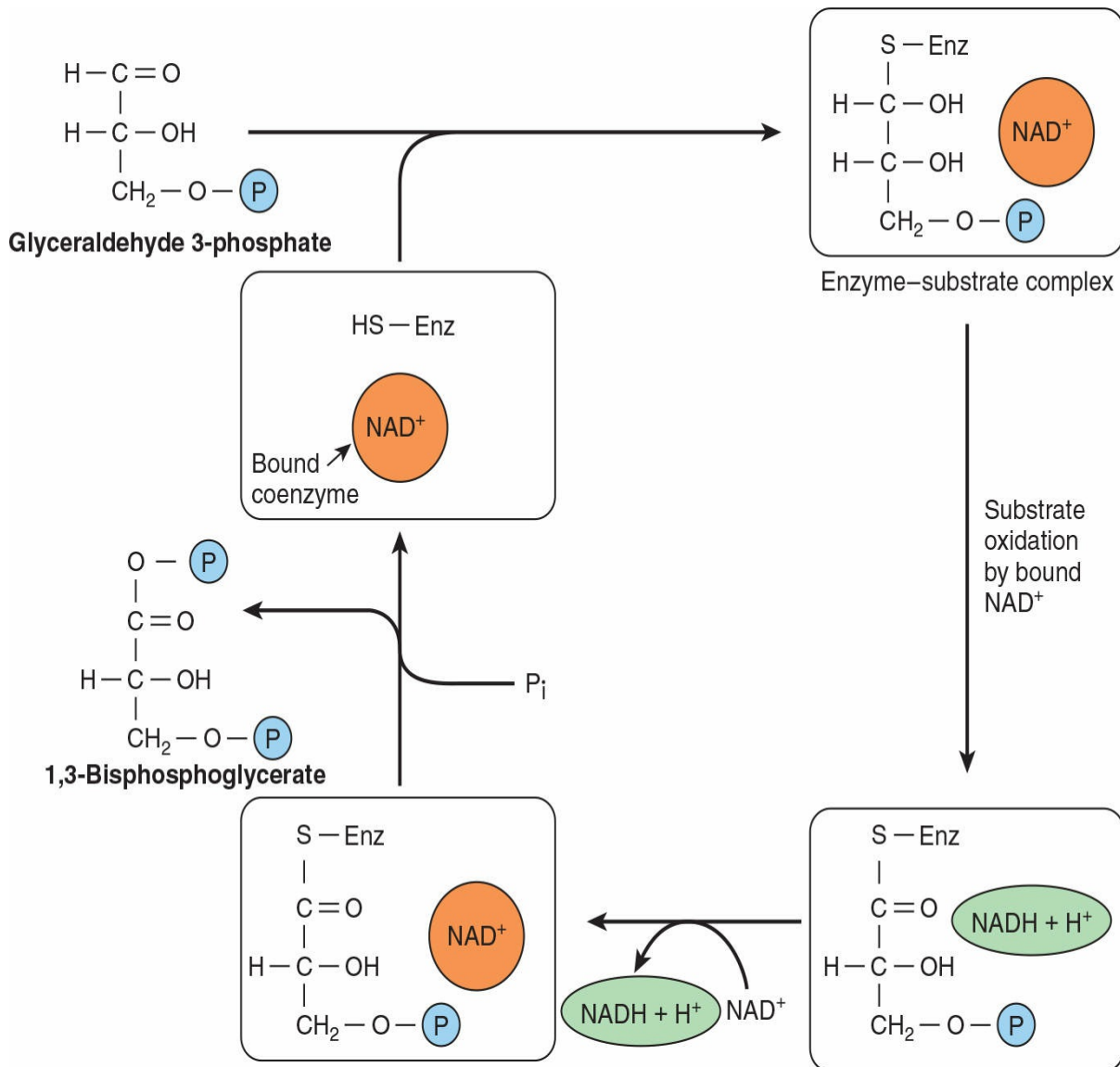

FIGURE 17-3 Mechanism of oxidation of glyceraldehyde-3-phosphate. (Enz, glyceraldehyde-3-phosphate dehydrogenase.) The enzyme is inhibited by the —SH poison iodoacetate, which is thus able to inhibit glycolysis. The NADH produced on the enzyme is not so firmly bound to the enzyme as is NAD^+ . Consequently, NADH is easily displaced by another molecule of NAD^+ .

In the next reaction, catalyzed by **phosphoglycerate kinase**, phosphate

is transferred from 1,3-bisphosphoglycerate onto ADP, forming ATP (substrate-level phosphorylation) and 3-phosphoglycerate. Since two molecules of triose phosphate are formed per molecule of glucose metabolized, $2\times$ ATP are formed in this reaction per molecule of glucose undergoing glycolysis. The toxicity of arsenic is the result of competition of arsenate with inorganic phosphate (P_i) forming 1-arseno-3-phosphoglycerate, which undergoes spontaneous hydrolysis to 3-phosphoglycerate without forming ATP. 3-Phosphoglycerate is isomerized to 2-phosphoglycerate by **phosphoglycerate mutase**. It is likely that 2,3-bisphosphoglycerate (diphosphoglycerate, DPG) is an intermediate in this reaction.

The subsequent step is catalyzed by **enolase** and involves a dehydration, forming phosphoenolpyruvate. Enolase is inhibited by **fluoride**, and when blood samples are taken for measurement of glucose, glycolysis is inhibited by taking the sample into tubes containing fluoride. Enolase is also dependent on the presence of either Mg^{2+} or Mn^{2+} ions. The phosphate of phosphoenolpyruvate is transferred to ADP in another substrate-level phosphorylation catalyzed by **pyruvate kinase** to form $2\times$ ATP per molecule of glucose oxidized. The reaction of pyruvate kinase is essentially irreversible under physiological conditions, partly because of the large free-energy change involved and partly because the immediate product of the enzyme-catalyzed reaction is enolpyruvate, which undergoes spontaneous isomerization to pyruvate, so that the product of the reaction is not available to undergo the reverse reaction.

The availability of oxygen now determines which of the two pathways is followed. Under **anaerobic conditions**, the NADH cannot be reoxidized through the respiratory chain, and pyruvate is reduced to lactate catalyzed by **lactate dehydrogenase**. This permits the oxidization of NADH, permitting another molecule of glucose to undergo glycolysis. Under **aerobic conditions**, pyruvate is transported into mitochondria and undergoes oxidative decarboxylation to acetyl-CoA then oxidation to CO_2 in the citric acid cycle (see [Chapter 16](#)). The reducing equivalents from the NADH formed in glycolysis are taken up into mitochondria for oxidation via either the malate-aspartate shuttle or the glycerophosphate shuttle (see [Chapter 13](#)).

TISSUES THAT FUNCTION UNDER HYPOXIC CONDITIONS PRODUCE LACTATE

This is true of skeletal muscle, particularly the white fibers, where the rate of work output, and hence the need for ATP formation, may exceed the rate at which oxygen can be taken up and utilized. Glycolysis in erythrocytes always terminates in lactate, because the subsequent reactions of pyruvate oxidation are mitochondrial, and erythrocytes lack mitochondria. Other tissues that normally derive much of their energy from glycolysis and produce lactate include brain, gastrointestinal tract, renal medulla, retina, and skin. Lactate production is also increased in septic shock, and many cancers also produce lactate. The liver, kidneys, and heart normally take up lactate and oxidize it, but produce it under hypoxic conditions.

When lactate production is high, as in vigorous exercise, septic shock, and cancer cachexia, much is used in the liver for gluconeogenesis (see [Chapter 19](#)), leading to an increase in metabolic rate to provide the ATP and GTP needed. The increase in oxygen consumption as a result of increased oxidation of metabolic fuels to provide the ATP and GTP needed for gluconeogenesis is seen as **oxygen debt** after vigorous exercise.

Under some conditions, lactate may be formed in the cytosol, but then enter the mitochondrion to be oxidized to pyruvate for onward metabolism. This provides a pathway for the transfer of reducing equivalents from the cytosol into the mitochondrion for the electron transport chain in addition to the glycerophosphate (see [Figure 13–12](#)) and malate-aspartate (see [Figure 13–13](#)) shuttles.

GLYCOLYSIS IS REGULATED AT THREE STEPS INVOLVING NONEQUILIBRIUM REACTIONS

Although most of the reactions of glycolysis are freely reversible, three are markedly exergonic and must therefore be considered to be physiologically irreversible. These reactions, catalyzed by **hexokinase** (and glucokinase), **phosphofructokinase**, and **pyruvate kinase**, are the major sites of regulation of glycolysis. Phosphofructokinase is significantly inhibited at normal intracellular concentrations of ATP; as discussed in [Chapter 19](#), this inhibition can be rapidly relieved by 5'AMP that is formed as ADP begins to accumulate, signaling the need for an increased rate of glycolysis. Cells that are capable of **gluconeogenesis** (reversing the glycolytic pathway, [Chapter 19](#)) have different enzymes that catalyze reactions to reverse these irreversible steps: glucose-6-phosphatase, fructose 1,6-bisphosphatase and, to reverse the reaction of

pyruvate kinase, pyruvate carboxylase, and phosphoenolpyruvate carboxykinase. The reciprocal regulation of phosphofructokinase in glycolysis and fructose 1,6-bisphosphatase in gluconeogenesis is discussed in [Chapter 19](#).

Fructose enters glycolysis by phosphorylation to fructose-1-phosphate, and bypasses the main regulatory steps, so resulting in formation of more pyruvate and acetyl-CoA than is required for ATP formation. In the liver and adipose tissue, this leads to increased lipogenesis, and a high intake of fructose may be a factor in the development of obesity.

In Erythrocytes, the First Site of ATP Formation in Glycolysis May Be Bypassed

In erythrocytes, the reaction catalyzed by **phosphoglycerate kinase** may be bypassed to some extent by the reaction of **bisphosphoglycerate mutase**, which catalyzes the conversion of 1,3-bisphosphoglycerate to 2,3-bisphosphoglycerate, followed by hydrolysis to 3-phosphoglycerate and P_i , catalyzed by **2,3-bisphosphoglycerate phosphatase** ([Figure 17–4](#)). This pathway involves no net yield of ATP from glycolysis, but provides 2,3-bisphosphoglycerate, which binds to hemoglobin, decreasing its affinity for oxygen, so making oxygen more readily available to tissues (see [Chapter 6](#)).

forms a long flexible arm, allowing the lipoic acid prosthetic group to rotate sequentially between the active sites of each of the enzymes of the complex. (FAD, flavin adenine dinucleotide; NAD^+ , nicotinamide adenine dinucleotide.)



The pyruvate dehydrogenase complex consists of a number of polypeptide chains of each of the three component enzymes and the intermediates do not dissociate, but are channeled from one enzyme site to the next. This increases the rate of reaction and prevents side reactions.

Pyruvate Dehydrogenase Is Regulated by End-Product Inhibition & Covalent Modification

Pyruvate dehydrogenase is inhibited by its products, acetyl-CoA and NADH (**Figure 17–6**). It is also regulated by phosphorylation (catalyzed by a kinase) of three serine residues on the pyruvate dehydrogenase component of the multienzyme complex, resulting in decreased activity and by dephosphorylation (catalyzed by a phosphatase) that causes an increase in activity. The kinase is activated by increases in the $[\text{ATP}]/[\text{ADP}]$, $[\text{acetyl-CoA}]/[\text{CoA}]$, and $[\text{NADH}]/[\text{NAD}^+]$ ratios. Thus, pyruvate dehydrogenase, and therefore glycolysis, is inhibited both when there is adequate ATP (and reduced coenzymes for ATP formation) available, and also when fatty acids are being oxidized. In fasting, when nonesterified fatty acid concentrations increase, there is a decrease in the proportion of the enzyme in the active form, leading to a sparing of carbohydrate. In adipose tissue, where glucose provides acetyl-CoA for lipogenesis, the enzyme is activated in response to insulin.

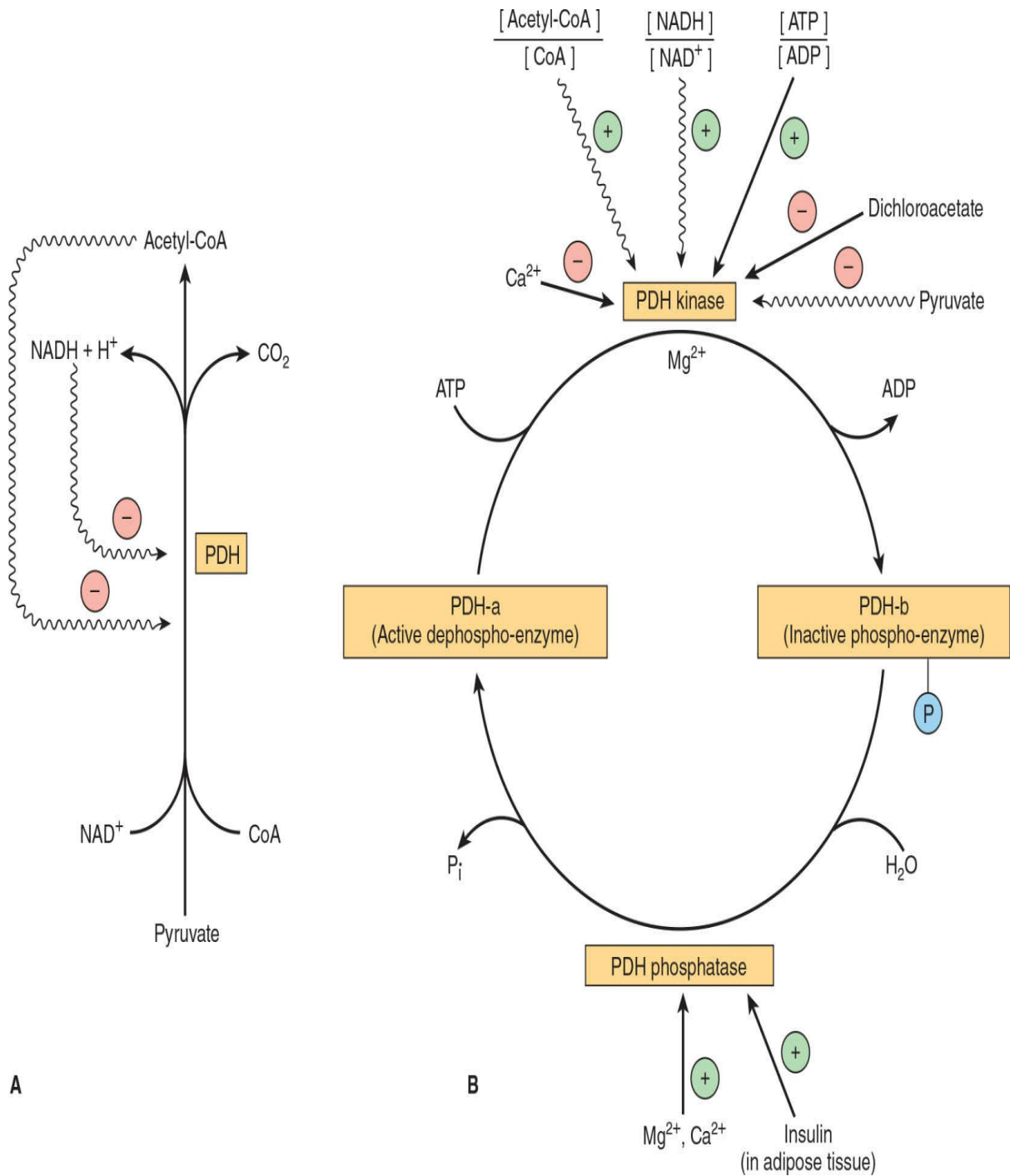

FIGURE 17–6 Regulation of pyruvate dehydrogenase (PDH). Arrows with wavy shafts indicate allosteric effects. **(A)** Regulation by end-product inhibition. **(B)** Regulation by interconversion of active and inactive forms.

CLINICAL ASPECTS

Inhibition of Pyruvate Metabolism Leads to Lactic Acidosis

Arsenite and mercuric ions react with the —SH groups of lipoic acid and inhibit pyruvate dehydrogenase, as does a **dietary deficiency of thiamin** (see [Chapter 44](#)), allowing pyruvate to accumulate. Many alcoholics are thiamin deficient (both because of a poor diet and also because alcohol inhibits thiamin absorption) and may develop potentially fatal pyruvic and lactic acidosis. Patients with **inherited pyruvate dehydrogenase deficiency**, which can be the result of defects in one or more of the components of the enzyme complex, also present with lactic acidosis, particularly after a glucose load. Because of the dependence of the brain on glucose as a fuel, these metabolic defects commonly cause neurological disturbances.

Inherited aldolase A deficiency and pyruvate kinase deficiency in erythrocytes cause **hemolytic anemia**. The exercise capacity of patients with **muscle phosphofructokinase deficiency** is low, particularly if they are on high-carbohydrate diets.

SUMMARY

- Glycolysis is the cytosolic pathway in all mammalian cells for the metabolism of glucose (or glycogen) to pyruvate and lactate.
- It can function anaerobically by regenerating oxidized NAD^+ (required in the glyceraldehyde-3-phosphate dehydrogenase reaction), by reducing pyruvate to lactate.
- Lactate is the end product of glycolysis under anaerobic conditions (eg, in exercising muscle) and in erythrocytes, where there are no mitochondria to permit further oxidation of pyruvate.
- Glycolysis is regulated by three enzymes catalyzing nonequilibrium reactions: hexokinase, phosphofructokinase, and pyruvate kinase.
- In erythrocytes, the first site in glycolysis for generation of ATP may be bypassed, leading to the formation of 2,3-bisphosphoglycerate, which is important in decreasing the affinity of hemoglobin for O_2 .
- Pyruvate is oxidized to acetyl-CoA by a multienzyme complex, pyruvate dehydrogenase, which is dependent on the vitamin-derived cofactor thiamin diphosphate.
- Conditions that involve an impairment of pyruvate metabolism frequently lead to lactic acidosis.

Metabolism of Glycogen

David A. Bender, PhD & Peter A. Mayes, PhD, DSc

OBJECTIVES

After studying this chapter, you should be able to:

- Describe the structure of glycogen and its importance as a carbohydrate reserve.
- Describe the synthesis and breakdown of glycogen and how the processes are regulated in response to hormone action.
- Describe the various types of glycogen storage diseases.

BIOMEDICAL IMPORTANCE

Glycogen is the major storage carbohydrate in animals, corresponding to starch in plants; it is a branched polymer of α -D-glucose (see [Figure 15–12](#)). It occurs mainly in liver and muscle, with modest amounts in the brain. Although the liver content of glycogen is greater than that of muscle, because the muscle mass of the body is considerably greater than that of the liver, about three-quarters of total body glycogen is in muscle ([Table 18–1](#)).

TABLE 18–1 Storage of Carbohydrate in a 70-kg Person

	Percentage of Tissue Weight	Tissue Weight	Body Content (g)
Liver glycogen	5.0	1.8 kg	90
Muscle glycogen	0.7	35 kg	245
Extracellular glucose	0.1	10 L	10

Muscle glycogen provides a readily available source of glucose-1-phosphate for glycolysis within the muscle itself. Liver glycogen functions as a reserve to maintain the **blood glucose** concentration in the fasting state. The liver concentration of glycogen is about 450 mmol/L glucose equivalents after a meal, falling to about 200 mmol/L after an overnight fast; after 12 to 18 hours of fasting, liver glycogen is almost totally depleted. Although muscle glycogen does not directly yield free glucose (because muscle lacks glucose-6-phosphatase), pyruvate formed by glycolysis in muscle can undergo transamination to alanine, which is exported from muscle and used for gluconeogenesis in the liver (see [Figure 19–4](#)). **Glycogen storage diseases** are a group of inherited disorders characterized by deficient mobilization of glycogen or deposition of abnormal forms of glycogen, leading to liver damage and muscle weakness; some result in early death.

The highly branched structure of glycogen (see [Figure 15–12](#)) provides a large number of sites for glycogenolysis, permitting rapid release of glucose-1-phosphate for muscle activity. Endurance athletes require a slower, more sustained release of glucose-1-phosphate. The formation of branch points in glycogen is slower than the addition of glucose units to a linear chain, and some endurance athletes practice **carbohydrate loading**—exercise to exhaustion (when muscle glycogen is largely depleted) followed by a high-carbohydrate meal, which results in rapid glycogen synthesis, with fewer branch points than normal.

GLYCOGENESIS OCCURS MAINLY IN MUSCLE & LIVER

Glycogen Biosynthesis Involves UDP-Glucose

As in glycolysis, glucose is phosphorylated to glucose-6-phosphate, catalyzed by **hexokinase** in muscle and **glucokinase** in liver ([Figure 18–](#)

1). Glucose-6-phosphate is isomerized to glucose-1-phosphate by **phosphoglucomutase**. The enzyme itself is phosphorylated, and the phosphate group takes part in a reversible reaction in which glucose 1,6-bisphosphate is an intermediate. Next, glucose-1-phosphate reacts with uridine triphosphate (UTP) to form the active nucleotide **uridine diphosphate glucose (UDPGlc)** and pyrophosphate (**Figure 18–2**), catalyzed by **UDPGlc pyrophosphorylase**. The reaction proceeds in the direction of UDPGlc formation because **pyrophosphatase** catalyzes hydrolysis of pyrophosphate to $2 \times$ phosphate, so removing one of the reaction products. UDPGlc pyrophosphorylase has a low K_m for glucose-1-phosphate and is present in relatively large amounts, so that it is not a regulatory step in glycogen synthesis.

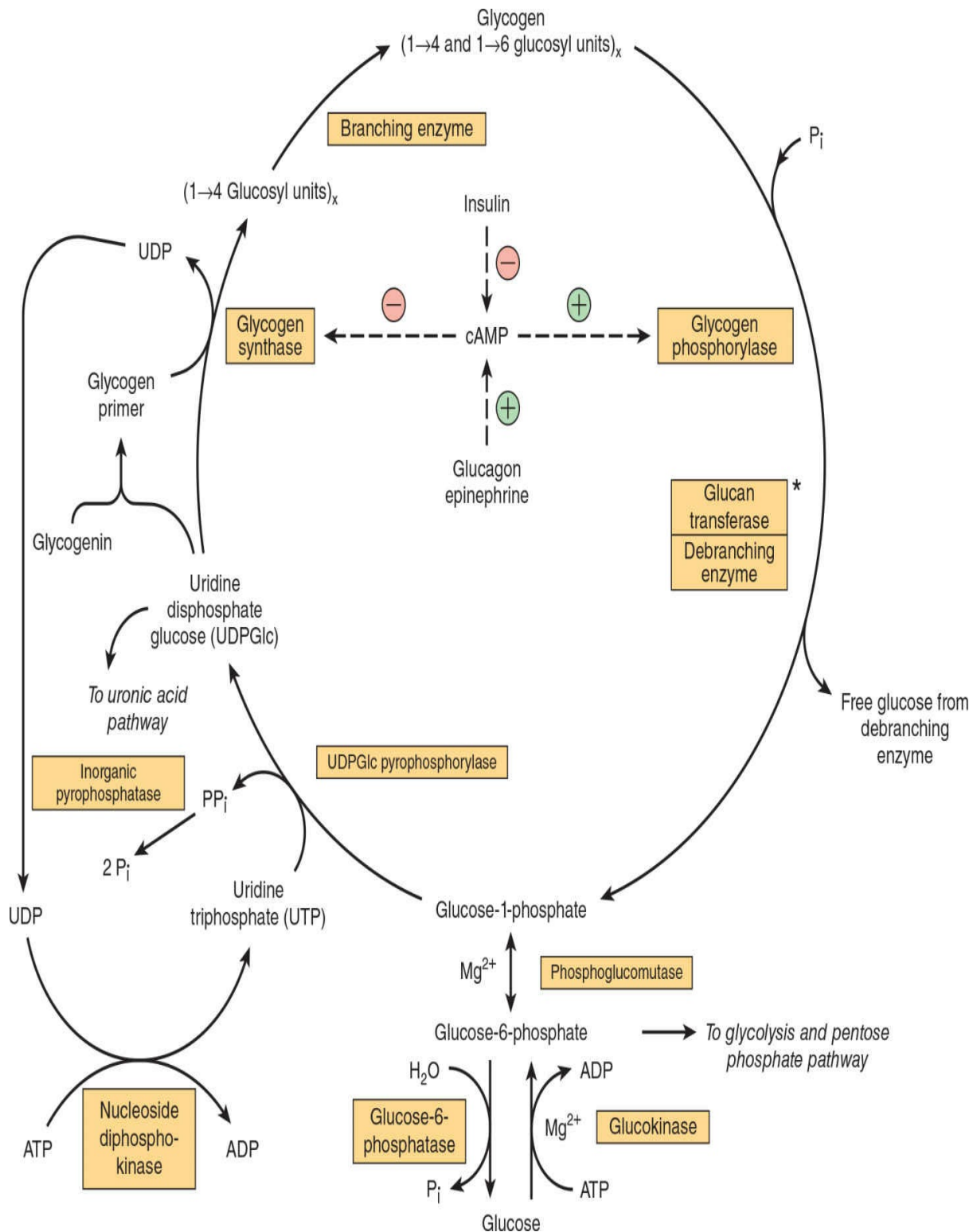

FIGURE 18–1 Pathways of glycogenesis and glycogenolysis in the liver. (⊕, Stimulation; ⊖, inhibition.) Insulin decreases the level of cAMP only after it has been raised by glucagon or epinephrine; that is, it antagonizes their action. Glucagon acts on heart muscle but not in skeletal muscle. * Glucan transferase and debranching enzyme appear to be two separate activities of the same enzyme.

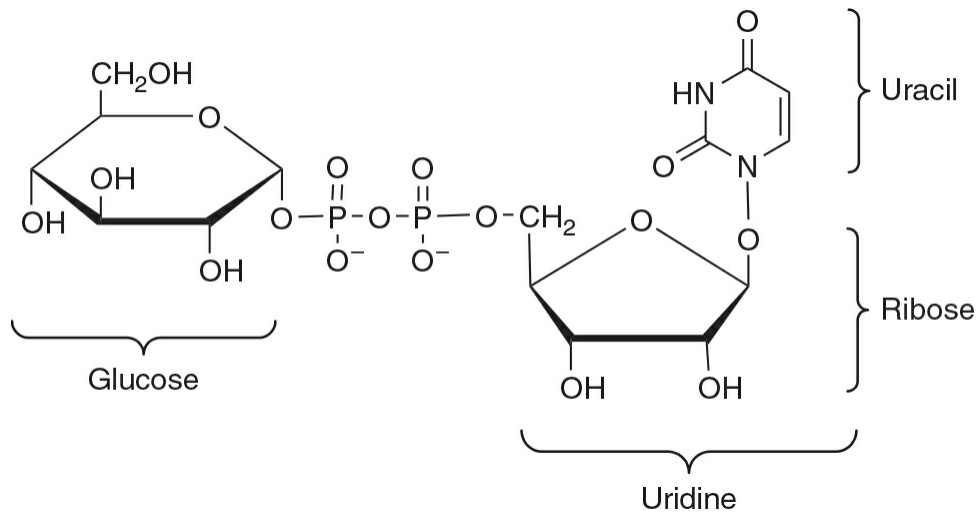

FIGURE 18–2 Uridine diphosphate glucose (UDPGlc).

The initial steps in glycogen synthesis involve the protein **glycogenin**, a 37-kDa protein that is glucosylated on a specific tyrosine residue by UDPGlc. Glycogenin catalyzes the transfer of a further seven glucose residues from UDPGlc, in 1 → 4 linkage, to form a **glycogen primer** that is the substrate for glycogen synthase. The glycogenin remains at the core of the glycogen granule (see [Figure 15–12](#)). **Glycogen synthase** catalyzes the formation of a glycoside bond between C-1 of the glucose of UDPGlc and C-4 of a terminal glucose residue of glycogen, liberating UDP. The addition of a glucose residue to a preexisting glycogen chain, or “primer,” occurs at the nonreducing, outer end of the molecule, so that the branches of the glycogen molecule become elongated as successive 1 → 4 linkages are formed ([Figure 18–3](#)).

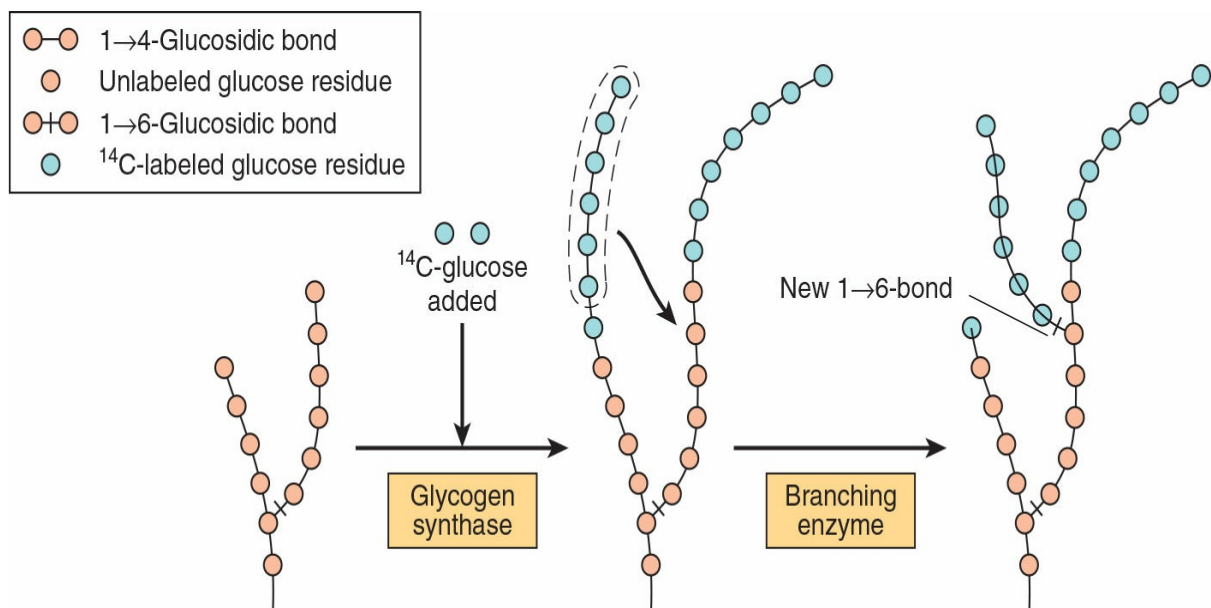

FIGURE 18–3 The biosynthesis of glycogen. The mechanism of branching as revealed by feeding ^{14}C -labeled glucose and examining liver glycogen at intervals.

Branching Involves Detachment of Existing Glycogen Chains

When a growing chain is at least 11 glucose residues long, **branching enzyme** transfers a part of the 1 → 4 chain (at least six glucose residues) to a neighboring chain to form a 1 → 6 linkage, establishing a **branch point**. The branches grow by further additions of 1 → 4-glucosyl units and further branching.

GLYCOGENOLYSIS IS NOT THE REVERSE OF GLYCOGENESIS, BUT IS A SEPARATE PATHWAY

Glycogen phosphorylase catalyzes the rate-limiting step in glycogenolysis—the phosphorolytic cleavage of the 1 → 4 linkages of glycogen to yield glucose-1-phosphate (**Figure 18–4**). There are different isoenzymes of glycogen phosphorylase in liver, muscle, and brain, encoded by different genes. Glycogen phosphorylase requires pyridoxal phosphate (see **Chapter 44**) as its coenzyme. Unlike the reactions of amino acid metabolism (see **Chapter 28**), in which the aldehyde group of the coenzyme is the reactive group, in phosphorylase it is the phosphate group that is catalytically active.

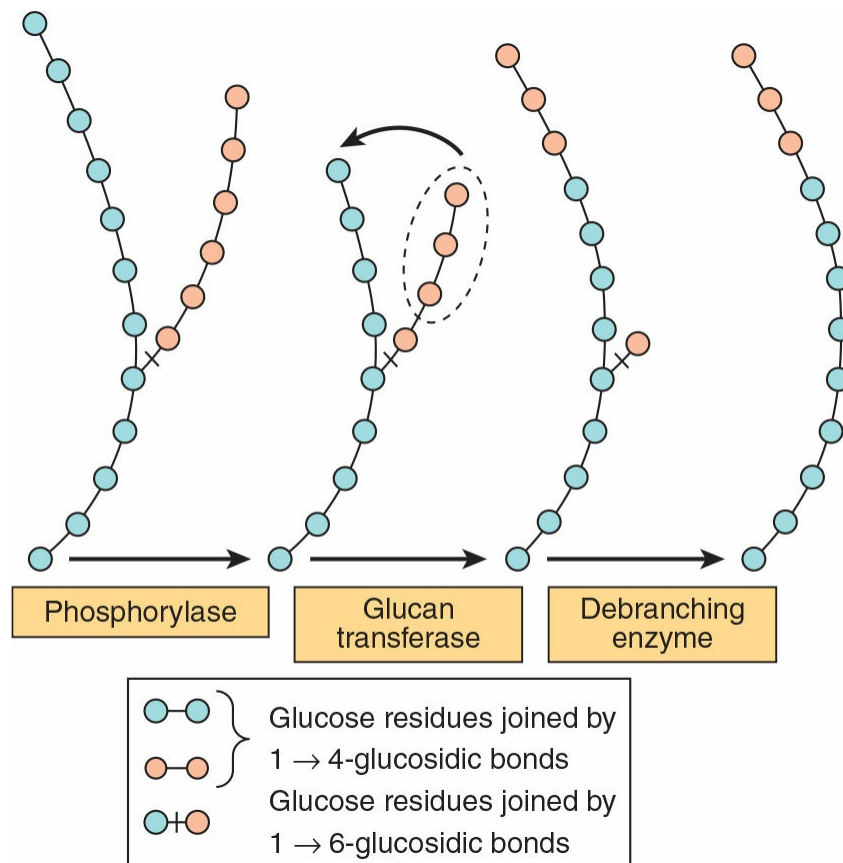

FIGURE 18–4 Steps in glycogenolysis.

The terminal glucosyl residues from the outermost chains of the glycogen molecule are removed sequentially until approximately four glucose residues remain on either side of a 1 → 6 branch (Figure 18–4). The **debranching enzyme** has two catalytic sites in a single polypeptide chain. One is a glucan transferase that transfers a trisaccharide unit from one branch to the other, exposing the 1 → 6 branch point. The other is a 1,6-glycosidase that catalyzes hydrolysis of the 1 → 6-glycoside bond to liberate free glucose. Further phosphorylase action can then proceed. The combined action of phosphorylase and these other enzymes leads to the complete breakdown of glycogen.

The reaction catalyzed by phosphoglucomutase is reversible, so that glucose-6-phosphate can be formed from glucose-1-phosphate. In **liver**, but not muscle, **glucose-6-phosphatase** catalyzes hydrolysis of glucose-6-phosphate, yielding glucose that is exported, leading to an increase in the blood glucose concentration. Glucose-6-phosphatase is in the lumen of the smooth endoplasmic reticulum, and genetic defects of the glucose-6-phosphate transporter can cause a variant of type I glycogen storage disease (Table 18–2).

TABLE 18–2 Glycogen Storage Diseases

Type	Name	Enzyme Deficiency	Clinical Features
0	—	Glycogen synthase	Hypoglycemia; hyperketonemia; early death
Ia	von Gierke disease	Glucose-6-phosphatase	Glycogen accumulation in liver and renal tubule cells; hypoglycemia; lactic acidemia; ketosis; hyperlipemia
Ib	—	Endoplasmic reticulum glucose-6-phosphate transporter	As type Ia; also neutropenia and impaired neutrophil function leading to recurrent infections
II	Pompe disease	Lysosomal $\alpha 1 \rightarrow 4$ and $\alpha 1 \rightarrow 6$ glucosidase (acid maltase)	Accumulation of glycogen in lysosomes: juvenile-onset variant, muscle hypotonia, death from heart failure by age 2; adult-onset variant, muscle dystrophy
IIIa	Limit dextrinosis, Forbes or Cori disease	Liver and muscle debranching enzyme	Fasting hypoglycemia; hepatomegaly in infancy; accumulation of characteristic branched polysaccharide (limit dextrin); muscle weakness
IIIb	Limit dextrinosis	Liver debranching enzyme	As type IIIa, but no muscle weakness
IV	Amylopectinosis, Andersen disease	Branching enzyme	Hepatosplenomegaly; accumulation of polysaccharide with few branch points; death from heart or liver failure before age 5
V	Myophosphorylase deficiency, McArdle syndrome	Muscle phosphorylase	Poor exercise tolerance; muscle glycogen abnormally high (2.5–4%); blood lactate very low after exercise
VI	Hers disease	Liver phosphorylase	Hepatomegaly; accumulation of glycogen in liver; mild hypoglycemia; generally good prognosis
VII	Tarui disease	Muscle and erythrocyte phosphofructokinase 1	Poor exercise tolerance; muscle glycogen abnormally high (2.5–4%); blood lactate very low after exercise; also hemolytic anemia
VIII		Liver phosphorylase kinase	Hepatomegaly; accumulation of glycogen in liver; mild hypoglycemia; generally good prognosis
IX		Liver and muscle phosphorylase kinase	Hepatomegaly; accumulation of glycogen in liver and muscle; mild hypoglycemia; generally good prognosis
X		cAMP-dependent protein kinase A	Hepatomegaly; accumulation of glycogen in liver

Abbreviation: cAMP, cyclic adenosine monophosphate.

Glycogen granules can also be engulfed by **lysosomes**, where acid maltase catalyzes the hydrolysis of glycogen to glucose. This may be especially important in glucose homeostasis in neonates. Genetic lack of lysosomal acid maltase causes type II glycogen storage disease (Pompe

disease, [Table 18–2](#)). The lysosomal catabolism of glycogen is under hormonal control.

CYCLIC AMP INTEGRATES THE REGULATION OF GLYCOGENOLYSIS & GLYCOGENESIS

The principal enzymes controlling glycogen metabolism—glycogen phosphorylase and glycogen synthase—are regulated in opposite directions by allosteric mechanisms and covalent modification by reversible phosphorylation and dephosphorylation of enzyme protein in response to hormone action (see [Chapter 9](#)). Phosphorylation of glycogen phosphorylase increases its activity; phosphorylation of glycogen synthase reduces its activity.

Phosphorylation is increased in response to cyclic AMP (cAMP) ([Figure 18–5](#)) formed from ATP by **adenylyl cyclase** at the inner surface of cell membranes in response to hormones such as **epinephrine**, **norepinephrine**, and **glucagon**. cAMP is hydrolyzed by **phosphodiesterase**, so terminating hormone action; in liver insulin increases the activity of phosphodiesterase.

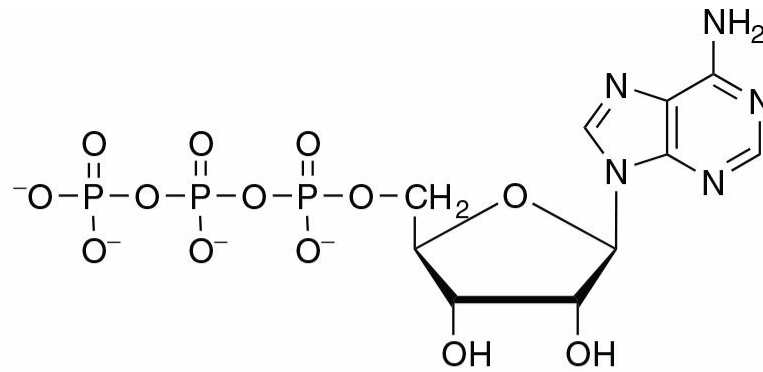

Adenosine triphosphate (ATP)

Adenylyl cyclase

Pyrophosphate

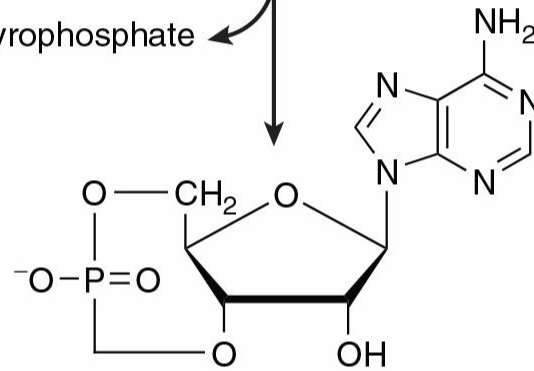

Cyclic adenosine monophosphate (cAMP)

H₂O

Phosphodiesterase

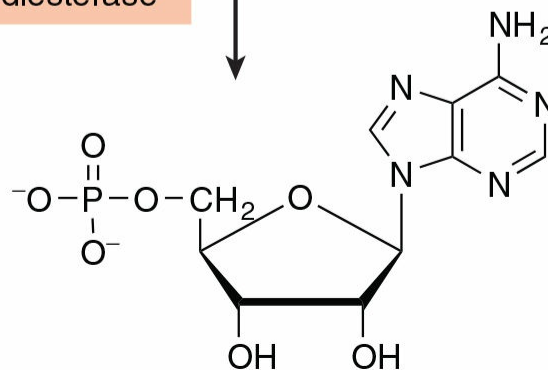

Adenosine monophosphate (5' AMP)

FIGURE 18–5 The formation and hydrolysis of cyclic AMP (3',5'-adenylic acid, cAMP).

Glycogen Phosphorylase Regulation Is Different in Liver & Muscle

In the liver, the role of glycogen is to provide free glucose for export to maintain the blood concentration of glucose; in muscle, the role of glycogen is to provide a source of glucose-6-phosphate for glycolysis in response to the need for ATP for muscle contraction. In both tissues, the enzyme is activated by phosphorylation catalyzed by phosphorylase kinase (to yield phosphorylase a) and inactivated by dephosphorylation catalyzed by phosphoprotein phosphatase (to yield phosphorylase b), in response to hormonal and other signals.

There is instantaneous overriding of this hormonal control. Active phosphorylase a in both tissues is allosterically inhibited by ATP and glucose-6-phosphate; in liver, but not muscle, free glucose is also an inhibitor. Muscle phosphorylase differs from the liver isoenzyme in having a binding site for 5' AMP (Figure 18–5), which acts as an allosteric activator of the (inactive) dephosphorylated b-form of the enzyme. 5' AMP acts as a potent signal of the energy state of the muscle cell; it is formed as the concentration of ADP begins to increase (indicating the need for increased substrate metabolism to permit ATP formation), as a result of the reaction of adenylate kinase: $2 \times \text{ADP} \leftrightarrow \text{ATP} + 5' \text{ AMP}$.

cAMP ACTIVATES GLYCOGEN PHOSPHORYLASE

Phosphorylase kinase is activated in response to cAMP (Figure 18–6). Increasing the concentration of cAMP activates **cAMP-dependent protein kinase**, which catalyzes the phosphorylation by ATP of inactive **phosphorylase kinase b** to active **phosphorylase kinase a**, which in turn, phosphorylates phosphorylase b to phosphorylase a. In the liver, cAMP is formed in response to glucagon, which is secreted in response to falling blood glucose. Muscle is insensitive to glucagon; in muscle, the signal for increased cAMP formation is the action of norepinephrine, which is secreted in response to fear or fright, when there is a need for increased glycogenolysis to permit rapid muscle activity.

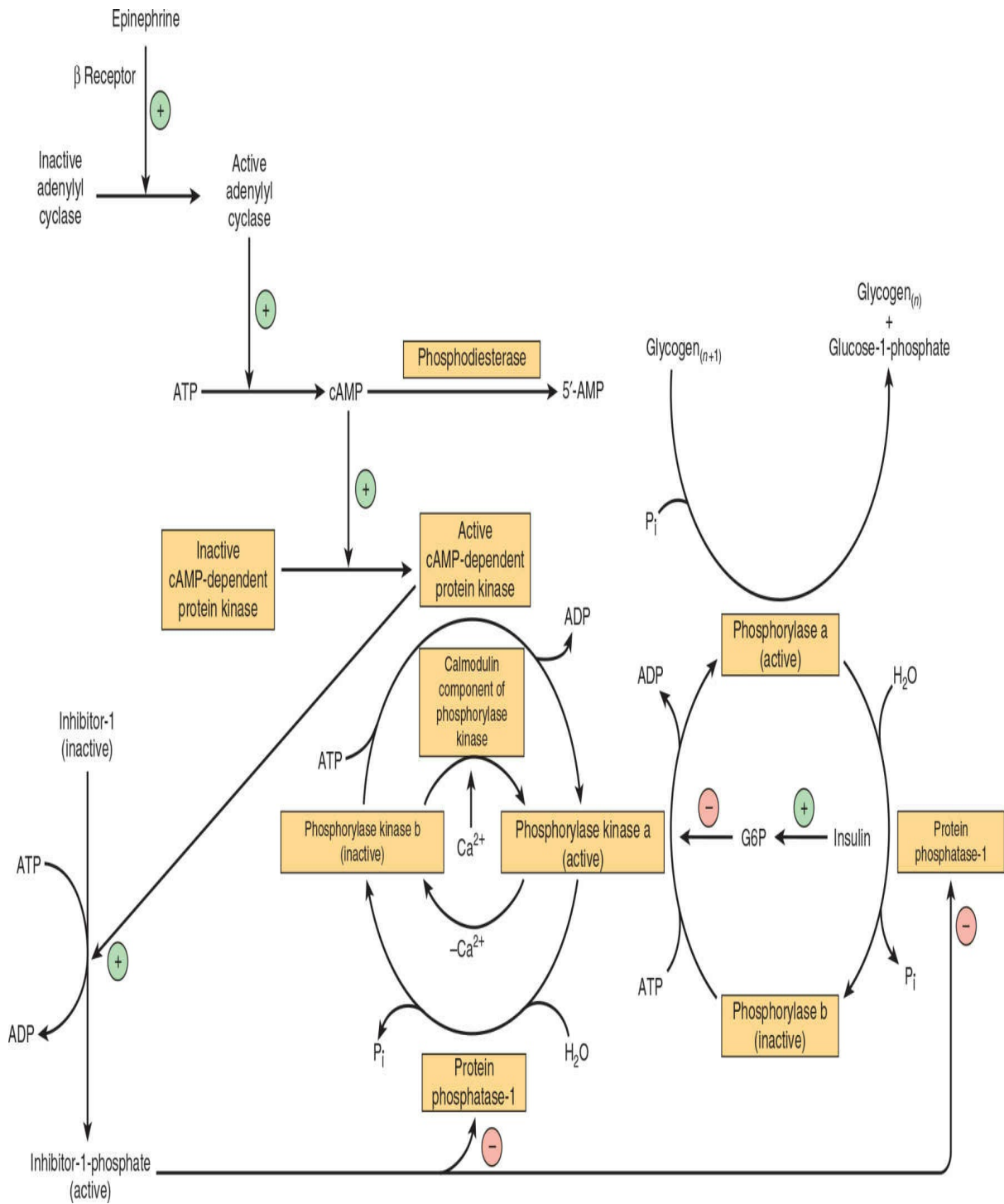

FIGURE 18–6 Control of glycogen phosphorylase in muscle. The sequence of reactions arranged as a cascade allows amplification of the hormonal signal at each step. (G6P, glucose-6-phosphate; n , number of glucose residues.)

Ca²⁺ Synchronizes the Activation of Glycogen Phosphorylase With Muscle Contraction

Glycogenolysis in muscle increases several 100-fold at the onset of contraction; the same signal (increased cytosolic Ca^{2+} ion concentration) is responsible for initiation of both contraction and glycogenolysis. Muscle phosphorylase kinase, which activates glycogen phosphorylase, is a tetramer of four different subunits, α , β , γ , and δ . The α and β subunits contain serine residues that are phosphorylated by cAMP-dependent protein kinase. The δ subunit is identical to the Ca^{2+} -binding protein **calmodulin** (see [Chapter 42](#)) and binds four Ca^{2+} . The binding of Ca^{2+} activates the catalytic site of the γ subunit even while the enzyme is in the dephosphorylated b state; the phosphorylated a form is only fully activated in the presence of high concentrations of Ca^{2+} .

Glycogenolysis in Liver Can Be cAMP-Independent

In the liver, there is cAMP-independent activation of glycogenolysis in response to stimulation of α_1 **adrenergic** receptors by epinephrine and norepinephrine. This involves mobilization of Ca^{2+} into the cytosol, followed by the stimulation of a **Ca^{2+} /calmodulin-sensitive phosphorylase kinase**. cAMP-independent glycogenolysis is also activated by vasopressin, oxytocin, and angiotensin II acting either through calcium or the phosphatidylinositol bisphosphate pathway (see [Figure 42–10](#)).

Protein Phosphatase-1 Inactivates Glycogen Phosphorylase

Both phosphorylase a and phosphorylase kinase a are dephosphorylated and inactivated by **protein phosphatase-1**. Protein phosphatase-1 is inhibited by a protein, **inhibitor-1**, which is active only after it has been phosphorylated by cAMP-dependent protein kinase. Thus, cAMP controls both the activation and inactivation of phosphorylase ([Figure 18–6](#)). **Insulin** reinforces this effect by inhibiting the activation of phosphorylase b. It does this indirectly by increasing uptake of glucose, leading to increased formation of glucose-6-phosphate, which is an inhibitor of phosphorylase kinase.

The Activities of Glycogen Synthase & Phosphorylase Are Reciprocally Regulated

There are different isoenzymes of glycogen synthase in liver, muscle, and brain. Like phosphorylase, glycogen synthase exists in both phosphorylated and nonphosphorylated states, and the effect of phosphorylation is the reverse of that seen in phosphorylase (**Figure 18–7**). Active **glycogen synthase a** is dephosphorylated and inactive **glycogen synthase b** is phosphorylated.

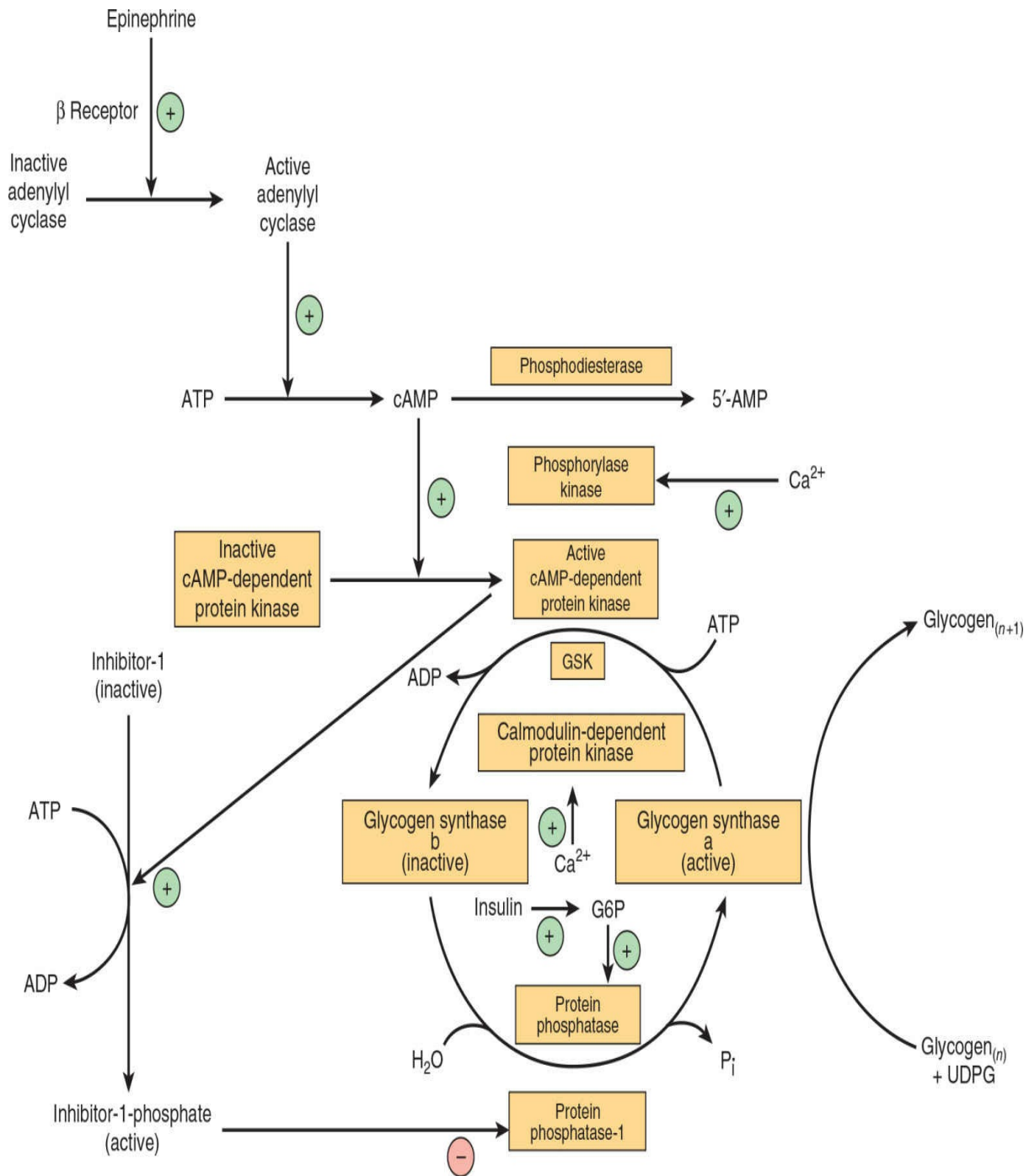

FIGURE 18–7 Control of glycogen synthase in muscle. (G6P, glucose-6-phosphate; GSK, glycogen synthase kinase; *n*, number of glucose

residues.)

Six different protein kinases act on glycogen synthase, and there are at least nine different serine residues in the enzyme that can be phosphorylated. Two of the protein kinases are Ca^{2+} /calmodulin dependent (one of these is phosphorylase kinase). Another kinase is cAMP-dependent protein kinase, which allows cAMP-mediated hormone action to inhibit glycogen synthesis synchronously with the activation of glycogenolysis. Insulin also promotes glycogenesis in muscle at the same time as inhibiting glycogenolysis by raising glucose-6-phosphate concentrations, which stimulates the dephosphorylation and activation of glycogen synthase. Dephosphorylation of glycogen synthase b is carried out by protein phosphatase-1, which is under the control of cAMP-dependent protein kinase.

GLYCOGEN METABOLISM IS REGULATED BY A BALANCE IN ACTIVITIES BETWEEN GLYCOGEN SYNTHASE & PHOSPHORYLASE

At the same time, as phosphorylase is activated by a rise in concentration of cAMP (via phosphorylase kinase), glycogen synthase is converted to the inactive form; both effects are mediated via **cAMP-dependent protein kinase (Figure 18–8)**. Thus, inhibition of glycogenolysis enhances net glycogenesis, and inhibition of glycogenesis enhances net glycogenolysis. Also, the dephosphorylation of phosphorylase a, phosphorylase kinase, and glycogen synthase b is catalyzed by a single enzyme with broad specificity—**protein phosphatase-1**. In turn, protein phosphatase-1 is inhibited by cAMP-dependent protein kinase via inhibitor-1. Thus, glycogenolysis can be terminated and glycogenesis can be stimulated, or vice versa, synchronously, because both processes are dependent on the activity of cAMP-dependent protein kinase. Both phosphorylase kinase and glycogen synthase may be reversibly phosphorylated at more than one site by separate kinases and phosphatases. These secondary phosphorylations modify the sensitivity of the primary sites to phosphorylation and dephosphorylation (**multisite phosphorylation**). Also, they allow insulin, by way of increased glucose-6-phosphate, to have effects that act reciprocally to those of cAMP (Figures 18–6 and 18–7).

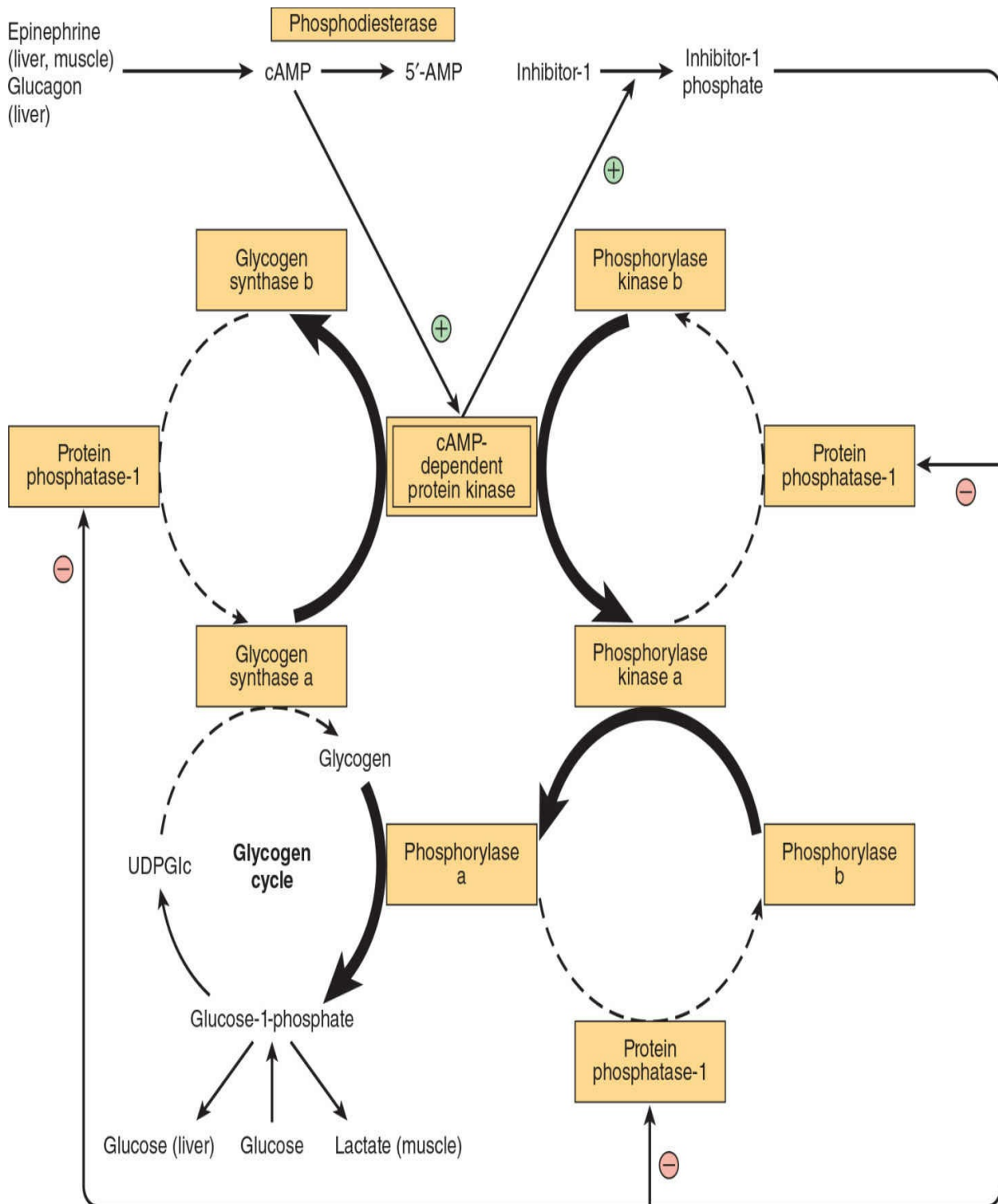

FIGURE 18–8 Coordinated control of glycogenolysis and glycogenesis by cAMP-dependent protein kinase. The reactions that lead to glycogenolysis as a result of an increase in cAMP concentrations are shown with bold arrows, and those that are inhibited by activation of protein phosphatase-1 are shown with dashed arrows. The reverse occurs when cAMP concentrations decrease as a result of phosphodiesterase activity, leading to glycogenesis.

CLINICAL ASPECTS

Glycogen Storage Diseases Are Inherited

Glycogen storage disease is a generic term to describe a group of inherited disorders characterized by deposition of an abnormal type or quantity of glycogen in tissues, or failure to mobilize glycogen. The principal diseases are summarized in [Table 18–2](#).

SUMMARY

- Glycogen represents the principal storage carbohydrate in the body, mainly in the liver and muscle.
- In the liver, its major function is to provide glucose for extrahepatic tissues. In muscle, it serves mainly as a source of metabolic fuel for use in muscle. Muscle lacks glucose-6-phosphatase and cannot release free glucose from glycogen.
- Glycogen is synthesized from glucose by the pathway of glycogenesis. It is broken down by a separate pathway, glycogenolysis.
- Cyclic AMP integrates the regulation of glycogenolysis and glycogenesis by promoting the simultaneous activation of phosphorylase and inhibition of glycogen synthase. Insulin acts reciprocally by inhibiting glycogenolysis and stimulating glycogenesis.
- Inherited deficiencies of enzymes of glycogen metabolism in both liver and muscle cause glycogen storage diseases.

Gluconeogenesis & the Control of Blood Glucose

David A. Bender, PhD & Peter A. Mayes, PhD, DSc

OBJECTIVES

After studying this chapter, you should be able to:

- Explain the importance of gluconeogenesis in glucose homeostasis.
- Describe the pathway of gluconeogenesis, how irreversible enzymes of glycolysis are bypassed, and how glycolysis and gluconeogenesis are regulated reciprocally.
- Explain how plasma glucose concentration is maintained within narrow limits in the fed and fasting states.

BIOMEDICAL IMPORTANCE

Gluconeogenesis is the process of synthesizing glucose from noncarbohydrate precursors. The major substrates are the glucogenic amino acids (see [Chapter 29](#)), lactate, glycerol, and propionate. Liver and kidney are the major gluconeogenic tissues; the kidney may contribute up

to 40% of total glucose synthesis in the fasting state and more in starvation. The key gluconeogenic enzymes are expressed in the small intestine, but it is unclear whether or not there is significant glucose production by the intestine in the fasting state, although propionate arising from intestinal bacterial fermentation of carbohydrates is a substrate for gluconeogenesis in enterocytes.

A supply of glucose is necessary especially for the nervous system and erythrocytes. After an overnight fast, glycogenolysis (see [Chapter 18](#)) and gluconeogenesis make approximately equal contributions to blood glucose; as glycogen reserves are depleted, so gluconeogenesis becomes progressively more important.

Failure of gluconeogenesis is usually fatal. **Hypoglycemia** causes brain dysfunction, which can lead to coma and death. Glucose is also important in maintaining adequate concentrations of intermediates of the citric acid cycle (see [Chapter 16](#)) even when fatty acids are the main source of acetyl-CoA in the tissues. In addition, gluconeogenesis clears lactate produced by muscle and erythrocytes, and glycerol produced by adipose tissue. In ruminants, propionate is a product of rumen metabolism of carbohydrates, and is a major substrate for gluconeogenesis.

Excessive gluconeogenesis occurs in **critically ill patients** in response to injury and infection, contributing to **hyperglycemia** which is associated with a poor outcome. Hyperglycemia leads to changes in osmolality of body fluids, impaired blood flow, intracellular acidosis, and increased superoxide radical production (see [Chapter 45](#)), resulting in deranged endothelial and immune system function and impaired blood coagulation. Excessive gluconeogenesis is also a contributory factor to hyperglycemia in **type 2 diabetes** because of impaired downregulation in response to insulin.

GLUCONEOGENESIS INVOLVES GLYCOLYSIS, THE CITRIC ACID CYCLE, PLUS SOME SPECIAL REACTIONS

Thermodynamic Barriers Prevent a Simple Reversal of Glycolysis

Three nonequilibrium reactions in glycolysis (see [Chapter 17](#)), catalyzed by hexokinase, phosphofructokinase, and pyruvate kinase, prevent simple reversal of glycolysis for glucose synthesis ([Figure 19–1](#)). They are

circumvented as follows.

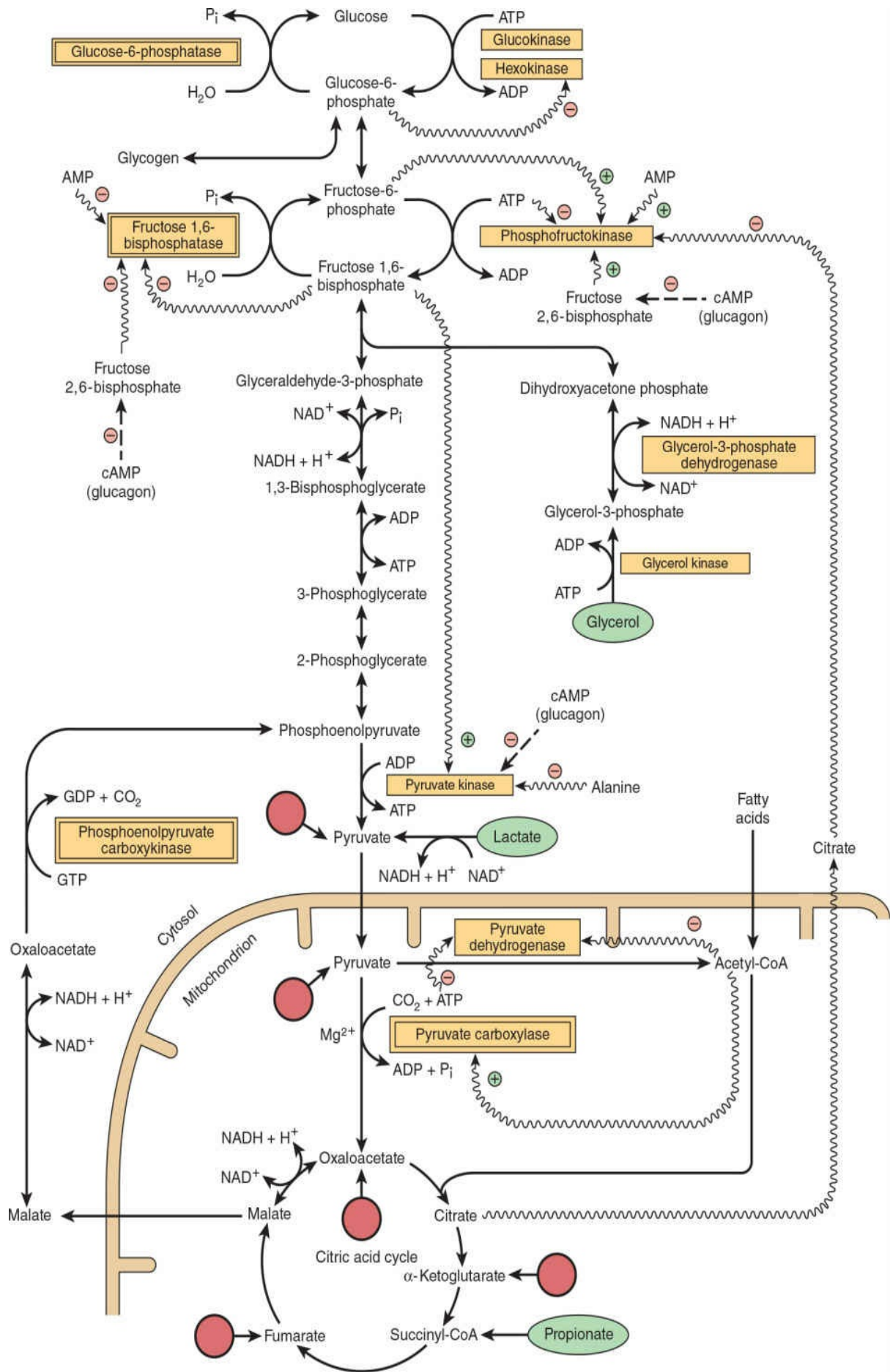

FIGURE 19–1 Major pathways and regulation of gluconeogenesis and glycolysis in the liver. Entry points of glucogenic amino acids after transamination are indicated by arrows extended from circles (see also [Figure 16–4](#)). The key gluconeogenic enzymes are shown in double-bordered boxes. The ATP required for gluconeogenesis is supplied by the oxidation of fatty acids. Propionate is important only in ruminants. Arrows with wavy shafts signify allosteric effects; dash-shafted arrows, covalent modification by reversible phosphorylation. High concentrations of alanine act as a “gluconeogenic signal” by inhibiting glycolysis at the pyruvate kinase step.

Pyruvate & Phosphoenolpyruvate

Reversal of the reaction catalyzed by pyruvate kinase in glycolysis involves two endothermic reactions. Mitochondrial **pyruvate carboxylase** catalyzes the carboxylation of pyruvate to oxaloacetate, an ATP-requiring reaction in which the vitamin biotin is the coenzyme. Biotin binds CO₂ from bicarbonate as carboxybiotin prior to the addition of the CO₂ to pyruvate (see [Figure 44–14](#)). The resultant oxaloacetate is reduced to malate, exported from the mitochondrion into the cytosol and there oxidized back to oxaloacetate. A second enzyme, **phosphoenolpyruvate carboxykinase**, catalyzes the decarboxylation and phosphorylation of oxaloacetate to phosphoenolpyruvate using GTP as the phosphate donor. In liver and kidney, the reaction of succinate thiokinase in the citric acid cycle (see [Chapter 16](#)) produces GTP (rather than ATP as in other tissues), and this GTP is used for the reaction of phosphoenolpyruvate carboxykinase, thus providing a link between citric acid cycle activity and gluconeogenesis, to prevent excessive removal of oxaloacetate for gluconeogenesis, which would impair citric acid cycle activity.

Fructose 1,6-Bisphosphate & Fructose-6-Phosphate

The conversion of fructose 1,6-bisphosphate to fructose-6-phosphate, for the reversal of glycolysis, is catalyzed by **fructose 1,6-bisphosphatase**. Its presence determines whether a tissue is capable of synthesizing glucose (or glycogen) not only from pyruvate but also from triose phosphates. It is present in liver, kidney, and skeletal muscle, but is probably absent from heart and smooth muscle.

Glucose-6-Phosphate & Glucose

The conversion of glucose-6-phosphate to glucose is catalyzed by **glucose-6-phosphatase**. It is present in liver and kidney, but absent from muscle, which, therefore, cannot export glucose into the bloodstream.

Glucose-1-Phosphate & Glycogen

The breakdown of glycogen to glucose-1-phosphate is catalyzed by phosphorylase. Glycogen synthesis involves a different pathway via uridine diphosphate glucose and **glycogen synthase** (see [Figure 18–1](#)).

The relationships between gluconeogenesis and the glycolytic pathway are shown in [Figure 19–1](#). After transamination or deamination, glucogenic amino acids yield either pyruvate or intermediates of the citric acid cycle. Therefore, the reactions described above can account for the conversion of both lactate and glucogenic amino acids to glucose or glycogen.

Propionate is a major precursor of glucose in ruminants; it enters gluconeogenesis via the citric acid cycle. After esterification with CoA, propionyl-CoA is carboxylated to D-methylmalonyl-CoA, catalyzed by **propionyl-CoA carboxylase**, a biotin-dependent enzyme ([Figure 19–2](#)). **Methylmalonyl-CoA racemase** catalyzes the conversion of D-methylmalonyl-CoA to L-methylmalonyl-CoA, which then undergoes isomerization to succinyl-CoA catalyzed by **methylmalonyl-CoA mutase**. In nonruminants, including human beings, propionate arises from the β -oxidation of odd-chain fatty acids that occur in ruminant lipids (see [Chapter 22](#)), as well as the oxidation of isoleucine and the side chain of cholesterol, and is a (relatively minor) substrate for gluconeogenesis. Methylmalonyl-CoA mutase is a vitamin B₁₂-dependent enzyme, and in deficiency, methylmalonic acid is excreted in the urine (**methylmalonic aciduria**).

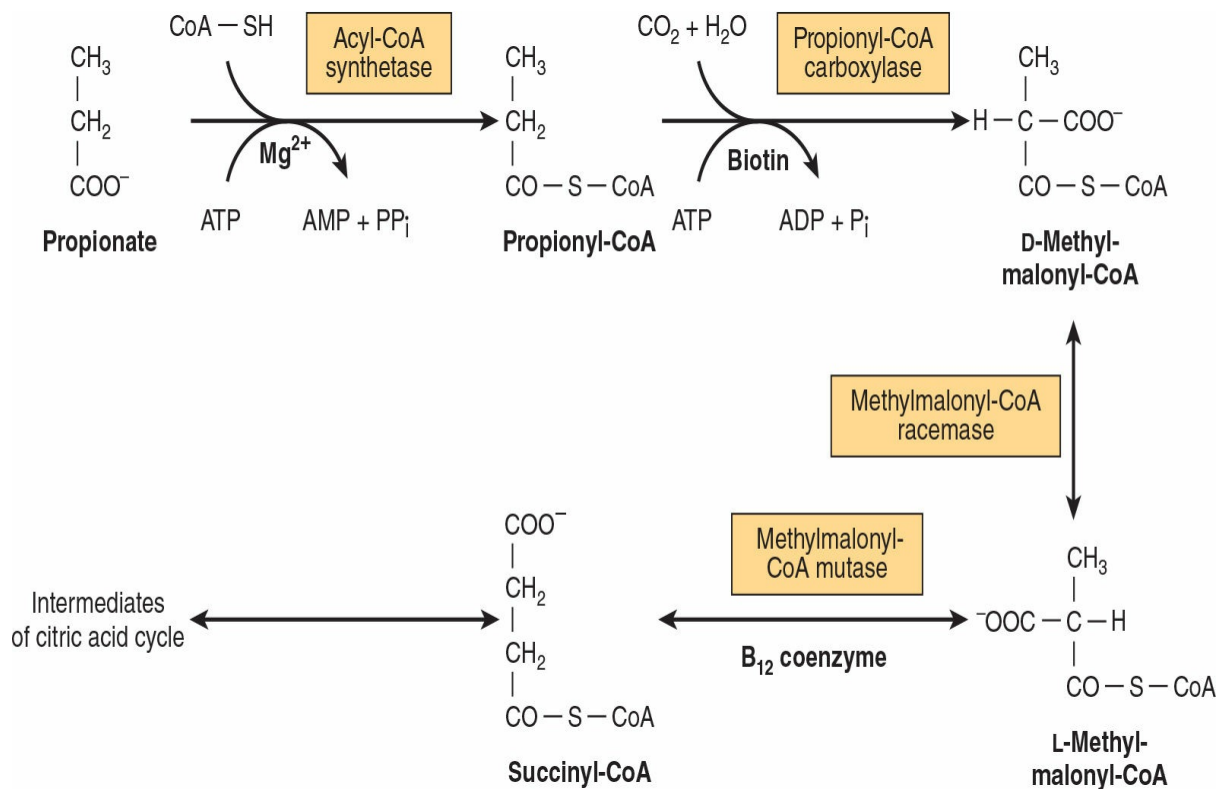

FIGURE 19–2 Metabolism of propionate.

Glycerol is released from adipose tissue as a result of lipolysis of lipoprotein triacylglycerol in the fed state; it may be used for reesterification of free fatty acids to triacylglycerol, or may be a substrate for gluconeogenesis in the liver. In the fasting state, glycerol released from lipolysis of adipose tissue triacylglycerol is used as a substrate for gluconeogenesis in the liver and kidneys.

GLYCOLYSIS & GLUCONEOGENESIS SHARE THE SAME PATHWAY BUT IN OPPOSITE DIRECTIONS, AND ARE RECIPROCALLY REGULATED

Changes in the availability of substrates are responsible for most changes in metabolism either directly or indirectly acting via changes in hormone secretion. Three mechanisms are responsible for regulating the activity of enzymes concerned in carbohydrate metabolism: (1) changes in the rate of enzyme synthesis, (2) covalent modification by reversible phosphorylation, and (3) allosteric effects.

Induction & Repression of Key Enzymes Require Several Hours

The changes in enzyme activity in the liver that occur under various metabolic conditions are listed in **Table 19–1**. The enzymes involved catalyze physiologically irreversible nonequilibrium reactions. The effects are generally reinforced because the activity of the enzymes catalyzing the reactions in the opposite direction varies reciprocally (see **Figure 19–1**). The enzymes involved in the utilization of glucose (ie, those of glycolysis and lipogenesis) become more active when there is a superfluity of glucose, and under these conditions the enzymes of gluconeogenesis have low activity. Insulin, secreted in response to increased blood glucose, enhances the synthesis of the key enzymes in glycolysis. It also antagonizes the effect of the glucocorticoids and glucagon-stimulated cAMP, which induce synthesis of the key enzymes of gluconeogenesis.

TABLE 19–1 Regulatory and Adaptive Enzymes Associated With Carbohydrate Metabolism

	Activity in		Inducer	Repressor	Activator	Inhibitor
	Carbohydrate Feeding	Fasting and Diabetes				
Glycogenolysis, glycolysis, and pyruvate oxidation						
Glycogen synthase	↑	↓			Insulin, glucose-6-phosphate	Glucagon
Hexokinase						Glucose-6-phosphate
Glucokinase	↑	↓	Insulin	Glucagon		
Phosphofructokinase-1	↑	↓	Insulin	Glucagon	5' AMP, fructose-6-phosphate, fructose 2,6-bisphosphate, P _i	Citrate, ATP, glucagon
Pyruvate kinase	↑	↓	Insulin, fructose	Glucagon	Fructose 1,6-bisphosphate, insulin	ATP, alanine, glucagon, norepinephrine
Pyruvate dehydrogenase	↑	↓			CoA, NAD ⁺ , insulin, ADP, pyruvate	Acetyl-CoA, NADH, ATP (fatty acids, ketone bodies)
Gluconeogenesis						
Pyruvate carboxylase	↓	↑	Glucocorticoids, glucagon, epinephrine	Insulin	Acetyl-CoA	ADP
Phosphoenolpyruvate carboxykinase	↓	↑	Glucocorticoids, glucagon, epinephrine	Insulin	Glucagon	
Glucose-6-phosphatase	↓	↑	Glucocorticoids, glucagon, epinephrine	Insulin		

Covalent Modification by Reversible Phosphorylation Is Rapid

Glucagon and **epinephrine**, hormones that are responsive to a decrease in blood glucose, inhibit glycolysis and stimulate gluconeogenesis in the liver

by increasing the concentration of cAMP. This in turn activates cAMP-dependent protein kinase, leading to the phosphorylation and inactivation of **pyruvate kinase**. They also affect the concentration of fructose 2,6-bisphosphate and therefore glycolysis and gluconeogenesis, as described below.

Allosteric Modification Is Instantaneous

In gluconeogenesis, pyruvate carboxylase, which catalyzes the synthesis of oxaloacetate from pyruvate, requires acetyl-CoA as an **allosteric activator**. The addition of acetyl-CoA results in a change in the tertiary structure of the protein, lowering the K_m for bicarbonate. This means that as acetyl-CoA is formed from pyruvate, it automatically ensures the provision of oxaloacetate, by activating pyruvate carboxylase. The activation of pyruvate carboxylase and the reciprocal inhibition of pyruvate dehydrogenase by acetyl-CoA derived from the oxidation of fatty acids explain the action of fatty acid oxidation in sparing the oxidation of pyruvate (and hence glucose) and stimulating gluconeogenesis. The reciprocal relationship between these two enzymes alters the metabolic fate of pyruvate as the tissue changes from carbohydrate oxidation (glycolysis) to gluconeogenesis during the transition from the fed to fasting state (see [Figure 19-1](#)). A major role of fatty acid oxidation in promoting gluconeogenesis is to supply the ATP that is required.

Phosphofructokinase (phosphofructokinase-1) occupies a key position in regulating glycolysis and is also subject to feedback control. It is inhibited by citrate and by normal intracellular concentrations of ATP and is activated by 5' AMP. At the normal intracellular [ATP] the enzyme is about 90% inhibited; this inhibition is reversed by 5' AMP ([Figure 19-3](#)).

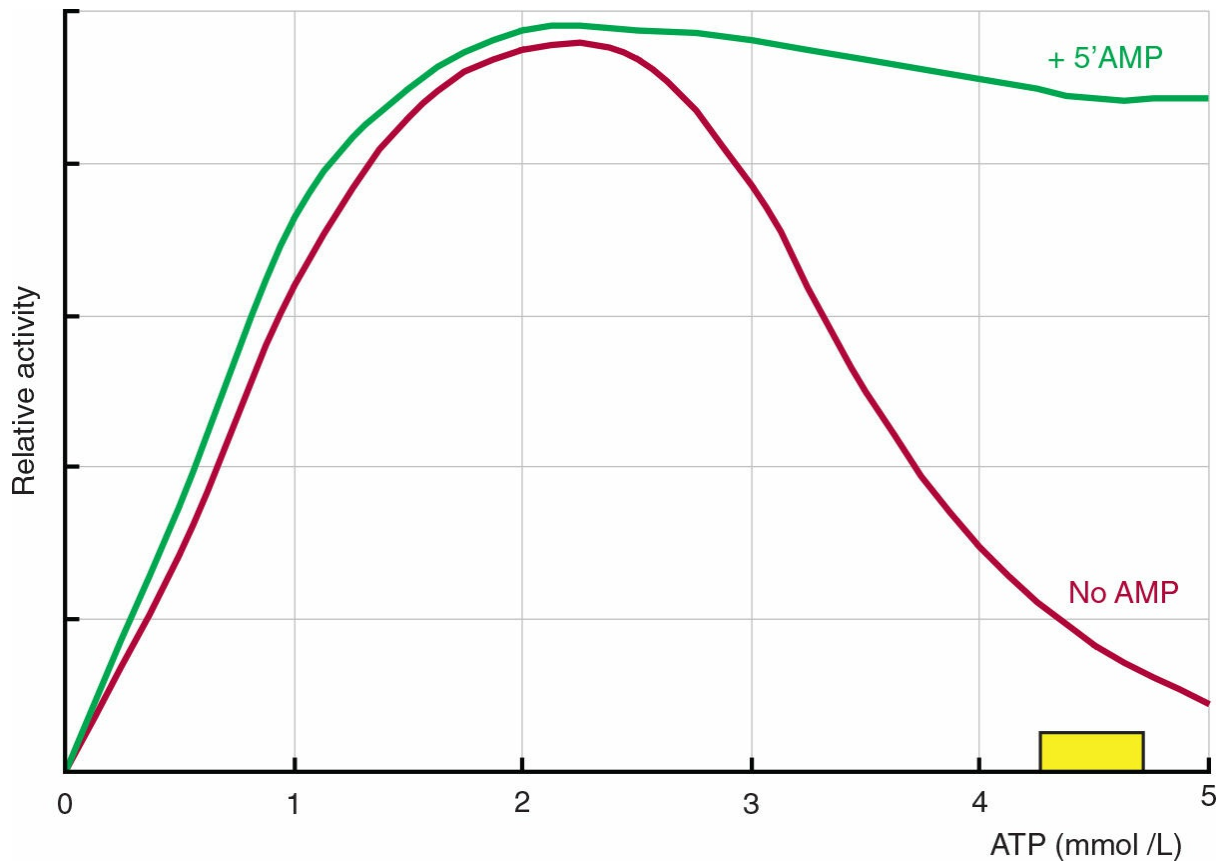

FIGURE 19-3 The inhibition of phosphofructokinase-1 by ATP and relief of inhibition by ATP. The yellow bar shows the normal range of the intracellular concentration of ATP.

5' AMP acts as an indicator of the energy status of the cell. The presence of **adenylyl kinase** in liver and many other tissues allows rapid equilibration of the reaction



Thus, when ATP is used in energy-requiring processes, resulting in the formation of ADP, [AMP] increases. A relatively small decrease in [ATP] causes a severalfold increase in [AMP], so that [AMP] acts as a metabolic amplifier of a small change in [ATP], and hence a sensitive signal of the energy state of the cell. The activity of phosphofructokinase-1 is thus regulated in response to the energy status of the cell to control the quantity of carbohydrate undergoing glycolysis prior to its entry into the citric acid cycle. At the same time, AMP activates glycogen phosphorylase, so increasing glycogenolysis. A consequence of the inhibition of phosphofructokinase-1 by ATP is an accumulation of glucose-6-phosphate, which in turn inhibits further uptake of glucose in extrahepatic

tissues by inhibition of hexokinase.

Fructose 2,6-Bisphosphate Plays a Unique Role in the Regulation of Glycolysis & Gluconeogenesis in Liver

The most potent positive allosteric activator of phosphofructokinase-1 and inhibitor of fructose 1,6-bisphosphatase in liver is **fructose 2,6-bisphosphate**. It relieves inhibition of phosphofructokinase-1 by ATP and increases the affinity for fructose-6-phosphate. It inhibits fructose 1,6-bisphosphatase by increasing the K_m for fructose 1,6-bisphosphate. Its concentration is under both substrate (allosteric) and hormonal control (covalent modification) (**Figure 19-4**).

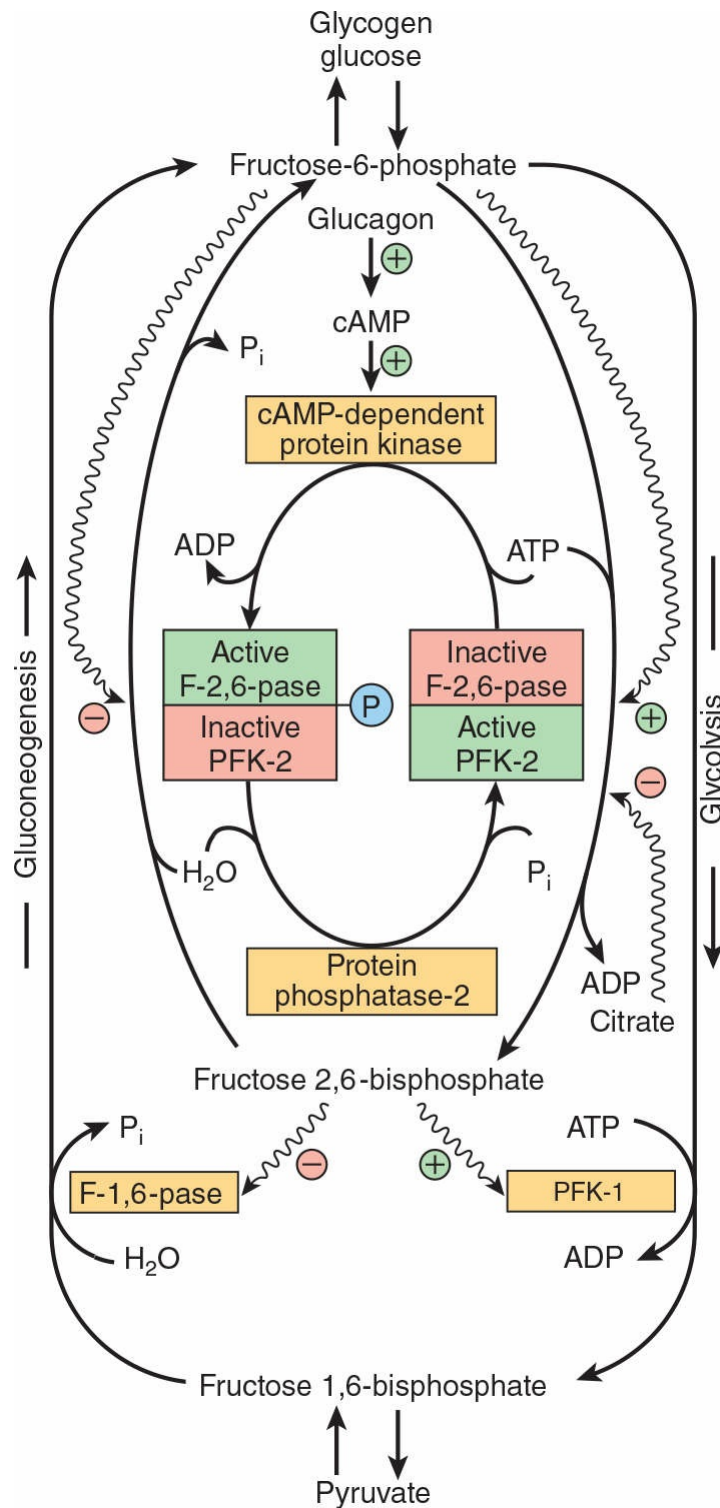

FIGURE 19–4 Control of glycolysis and gluconeogenesis in the liver by fructose 2,6-bisphosphate and the bifunctional enzyme PFK-2/F-2,6-Pase (6-phosphofructo-2-kinase/fructose 2,6-bisphosphatase). (F-1,6-Pase, fructose 1,6-bisphosphatase; PFK-1, phosphofructokinase-1 [6-phosphofructo-1-kinase].) Arrows with wavy shafts indicate allosteric effects.

Fructose 2,6-bisphosphate is formed by phosphorylation of fructose-6-phosphate by **phosphofructokinase-2**. The same enzyme protein is also responsible for its breakdown, since it has **fructose 2,6-bisphosphatase** activity. This **bifunctional enzyme** is under the allosteric control of fructose-6-phosphate, which stimulates the kinase and inhibits the phosphatase. Hence, when there is an abundant supply of glucose, the concentration of fructose 2,6-bisphosphate increases, stimulating glycolysis by activating phosphofructokinase-1 and inhibiting fructose 1,6-bisphosphatase. In the fasting state, glucagon stimulates the production of cAMP, activating cAMP-dependent protein kinase, which in turn inactivates phosphofructokinase-2 and activates fructose 2,6-bisphosphatase by phosphorylation. Hence, gluconeogenesis is stimulated by a decrease in the concentration of fructose 2,6-bisphosphate, which inactivates phosphofructokinase-1 and relieves the inhibition of fructose 1,6-bisphosphatase. Xylulose 5-phosphate, an intermediate of the pentose phosphate pathway (see [Chapter 20](#)) activates the protein phosphatase that dephosphorylates the bifunctional enzyme, so increasing the formation of fructose 2,6-bisphosphate and increasing the rate of glycolysis. This leads to increased flux through glycolysis and the pentose phosphate pathway and increased fatty acid synthesis (see [Chapter 23](#)).

Substrate (Futile) Cycles Allow Fine Tuning & Rapid Response

The control points in glycolysis and glycogen metabolism involve a cycle of phosphorylation and dephosphorylation catalyzed by glucokinase and glucose-6-phosphatase; phosphofructokinase-1 and fructose 1,6-bisphosphatase; pyruvate kinase, pyruvate carboxylase, and phosphoenolpyruvate carboxykinase; and glycogen synthase and phosphorylase. It would seem obvious that these opposing enzymes are regulated in such a way that when those involved in glycolysis are active, those involved in gluconeogenesis are inactive, since otherwise there would be cycling between phosphorylated and nonphosphorylated intermediates, with net hydrolysis of ATP. While this is so, in muscle both phosphofructokinase and fructose 1,6-bisphosphatase have some activity at all times, so that there is indeed some measure of (wasteful) substrate cycling. This permits the very rapid increase in the rate of glycolysis necessary for muscle contraction. At rest the rate of phosphofructokinase activity is some 10-fold higher than that of fructose 1,6-bisphosphatase; in anticipation of muscle contraction, the activity of both enzymes increases,

fructose 1,6-bisphosphatase 10 times more than phosphofructokinase, maintaining the same net rate of glycolysis. At the start of muscle contraction, the activity of phosphofructokinase increases further, and that of fructose 1,6-bisphosphatase falls, so increasing the net rate of glycolysis (and hence ATP formation) as much as a 1000-fold.

THE BLOOD CONCENTRATION OF GLUCOSE IS REGULATED WITHIN NARROW LIMITS

In the postabsorptive state, the concentration of blood glucose is maintained between 4.5 and 5.5 mmol/L. After the ingestion of a carbohydrate meal, it may rise to 6.5 to 7.2 mmol/L, and in starvation, it may fall to 3.3 to 3.9 mmol/L. A sudden decrease in blood glucose (eg, in response to insulin overdose) causes convulsions, because of the dependence of the brain on a supply of glucose. However, much lower concentrations can be tolerated if hypoglycemia develops slowly enough for adaptation to occur. The blood glucose level in birds is considerably higher (14 mmol/L) and in ruminants considerably lower (~ 2.2 mmol/L in sheep and 3.3 mmol/L in cattle). These lower normal levels appear to be associated with the fact that ruminants ferment virtually all dietary carbohydrate to short-chain fatty acids, and these largely replace glucose as the main metabolic fuel of the tissues in the fed state.

BLOOD GLUCOSE IS DERIVED FROM THE DIET, GLUCONEOGENESIS, & GLYCOGENOLYSIS

The digestible dietary carbohydrates yield glucose, galactose, and fructose that are transported to the liver via the **hepatic portal vein**. Galactose and fructose are readily converted to glucose in the liver (see [Chapter 20](#)).

Glucose is formed from two groups of compounds that undergo gluconeogenesis (see [Figures 16–4](#) and [19–1](#)): (1) those that involve a direct net conversion to glucose, including most **amino acids** and **propionate** and (2) those that are the products of the metabolism of glucose in tissues. Thus, **lactate**, formed by glycolysis in skeletal muscle and erythrocytes, is transported to the liver and kidney where it reforms glucose, which again becomes available via the circulation for oxidation in the tissues. This process is known as the **Cori cycle**, or the **lactic acid cycle** ([Figure 19–5](#)).

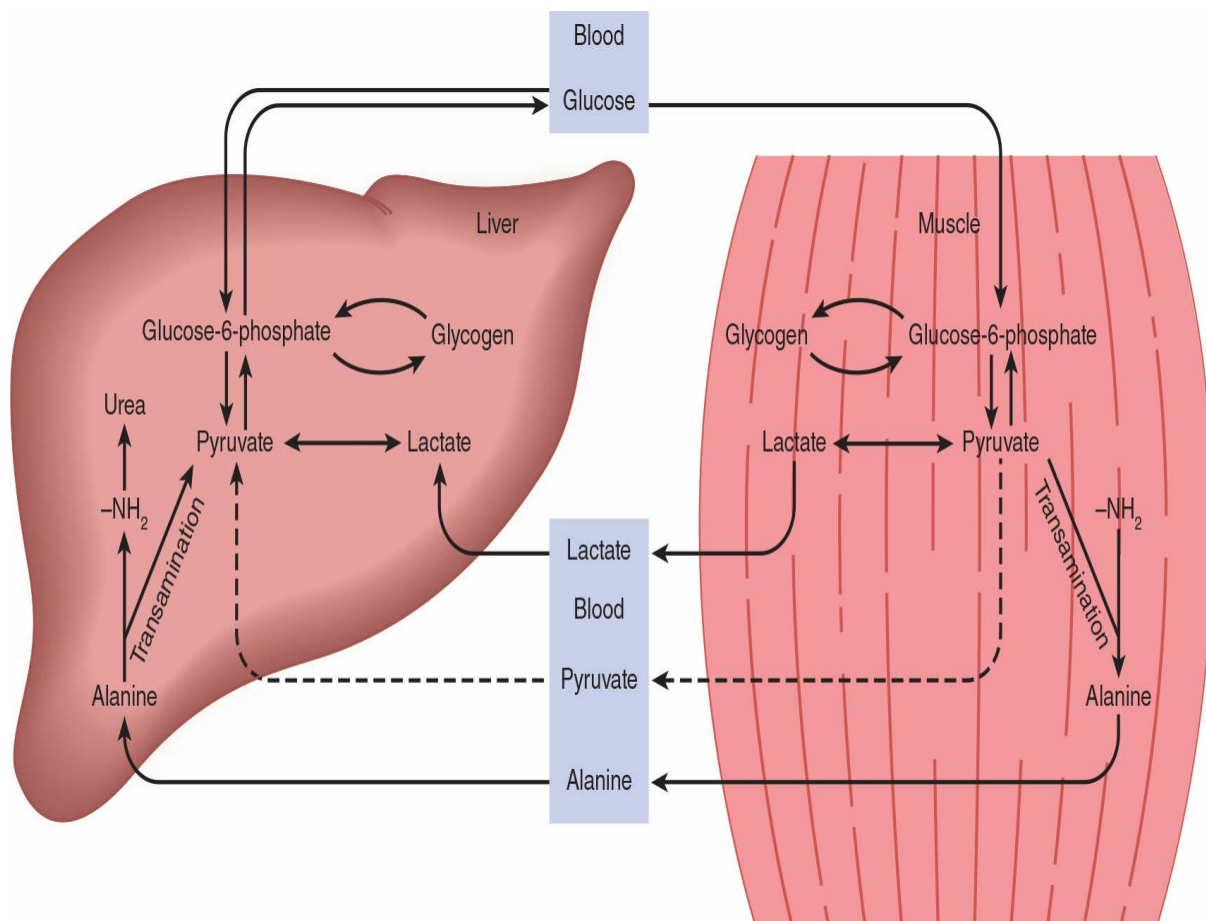

FIGURE 19–5 The lactic acid (Cori cycle) and glucose-alanine cycles.

In the fasting state, there is a considerable output of alanine from skeletal muscle, far in excess of the amount in the muscle proteins that are being catabolized. It is formed by transamination of pyruvate produced by glycolysis of muscle glycogen, and is exported to the liver, where, after transamination back to pyruvate, it is a substrate for gluconeogenesis. This **glucose-alanine cycle** (see Figure 19–5) provides an indirect way of utilizing muscle glycogen to maintain blood glucose in the fasting state. The ATP required for the hepatic synthesis of glucose from pyruvate is formed by the oxidation of fatty acids.

Glucose is also formed from liver glycogen by glycogenolysis (see Chapter 18).

Metabolic & Hormonal Mechanisms Regulate the Concentration of Blood Glucose

The maintenance of a stable blood glucose concentration is one of the most finely regulated of all homeostatic mechanisms, involving the liver,

extrahepatic tissues, and several hormones. Liver cells are freely permeable to glucose in either direction (via the GLUT 2 transporter), whereas cells of extrahepatic tissues (apart from pancreatic β -islets) are relatively impermeable, and their unidirectional glucose transporters are regulated by insulin. As a result, uptake from the bloodstream is the rate-limiting step in the utilization of glucose in extrahepatic tissues. The role of various glucose transporter proteins found in cell membranes is shown in **Table 19–2**.

TABLE 19–2 Major Glucose Transporters

Tissue Location		Functions
Facilitative bidirectional transporters		
GLUT 1	Brain, kidney, colon, placenta, erythrocytes	Glucose uptake
GLUT 2	Liver, pancreatic β cell, small intestine, kidney	Rapid uptake or release of glucose
GLUT 3	Brain, kidney, placenta	Glucose uptake
GLUT 4	Heart and skeletal muscle, adipose tissue	Insulin-stimulated glucose uptake
GLUT 5	Small intestine	Absorption of fructose
Sodium-dependent unidirectional transporter		
SGLT 1	Small intestine and kidney	Active uptake of glucose against a concentration gradient

Glucokinase Is Important in Regulating Blood Glucose After a Meal

Hexokinase has a low K_m for glucose, and in the liver it is saturated and acting at a constant rate under all normal conditions. It thus acts to ensure an adequate rate of glycolysis to meet the liver's needs. Glucokinase is an allosteric enzyme with a considerably higher apparent K_m (lower affinity) for glucose, so that its activity increases with increases in the concentration of glucose in the hepatic portal vein (**Figure 19–6**). In the fasting state, glucokinase is located in the nucleus. In response to an increased intracellular concentration of glucose it migrates into the cytosol, mediated by the carbohydrate response element-binding protein (CREBP). It thus permits hepatic uptake of large amounts of glucose after a carbohydrate meal, for glycogen and fatty acid synthesis, so that while the concentration of glucose in the hepatic portal vein may reach 20 mmol/L after a meal,

that leaving the liver into the peripheral circulation does not normally exceed 8 to 9 mmol/L. Glucokinase is absent from the liver of ruminants, which have little glucose entering the portal circulation from the intestines.

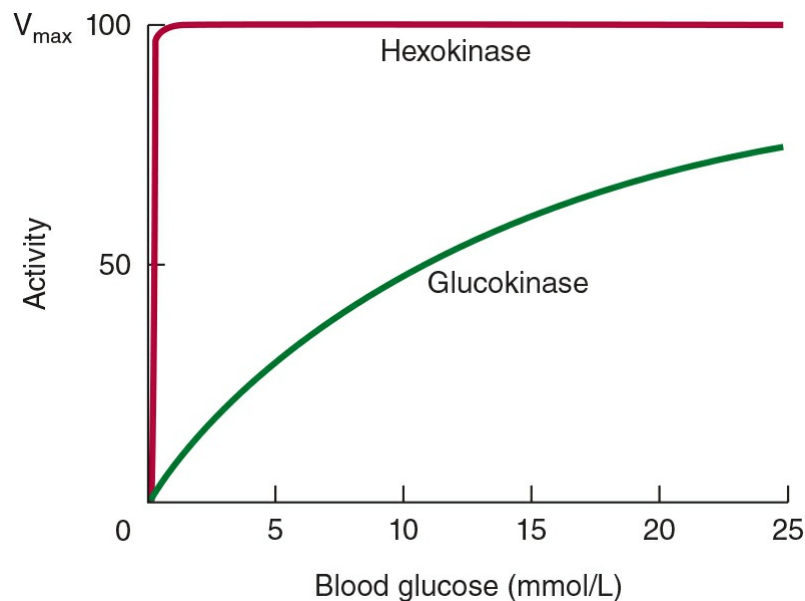

FIGURE 19–6 Variation in glucose phosphorylating activity of hexokinase and glucokinase with increasing blood glucose concentration. The K_m for glucose of hexokinase is 0.05 mmol/L and of glucokinase is 10 mmol/L.

At normal peripheral blood glucose concentrations (4.5-5.5 mmol/L), the liver is a net producer of glucose. However, as the glucose level rises, the output of glucose ceases, and there is a net uptake.

Insulin and Glucagon Play a Central Role in Regulating Blood Glucose

In addition to the direct effects of hyperglycemia in enhancing the uptake of glucose into the liver, the hormone **insulin** plays a central role in regulating blood glucose. It is produced by the β cells of the islets of Langerhans in the pancreas in response to hyperglycemia. The β -islet cells are freely permeable to glucose via the GLUT 2 transporter, and the glucose is phosphorylated by glucokinase. Therefore, increasing blood glucose increases metabolic flux through glycolysis, the citric acid cycle, and the generation of ATP. The increase in [ATP] inhibits ATP-sensitive K^+ channels, causing depolarization of the cell membrane, which increases Ca^{2+} influx via voltage-sensitive Ca^{2+} channels, stimulating exocytosis of

insulin. Thus, the concentration of insulin in the blood parallels that of the blood glucose. Other substances causing release of insulin from the pancreas include amino acids, nonesterified fatty acids, ketone bodies, glucagon, secretin, and the sulfonylurea drugs tolbutamide and glyburide. These drugs are used to stimulate insulin secretion in type 2 diabetes mellitus via the ATP-sensitive K^+ channels. Epinephrine and norepinephrine block the release of insulin. Insulin acts to lower blood glucose immediately by enhancing glucose transport into adipose tissue and muscle by recruitment of glucose transporters (GLUT 4) from the interior of the cell to the plasma membrane. Although it does not affect glucose uptake into the liver directly, insulin does enhance long-term uptake as a result of its actions on the enzymes controlling glycolysis, glycogenesis, and gluconeogenesis (see [Chapter 18](#) and [Table 19–1](#)).

Glucagon is the hormone produced by the α cells of the pancreatic islets in response to hypoglycemia. In the liver, it stimulates glycogenolysis by activating glycogen phosphorylase. Unlike epinephrine, glucagon does not have an effect on muscle phosphorylase. Glucagon also enhances gluconeogenesis from amino acids and lactate. In all these actions, glucagon acts via generation of cAMP ([Table 19–1](#)). Both hepatic glycogenolysis and gluconeogenesis contribute to the **hyperglycemic effect** of glucagon, whose actions oppose those of insulin. Most of the endogenous glucagon (and insulin) is cleared from the circulation by the liver ([Table 19–3](#)).

TABLE 19–3 Tissue Responses to Insulin and Glucagon

	Liver	Adipose Tissue	Muscle
Increased by insulin	Fatty acid synthesis	Glucose uptake	Glucose uptake
	Glycogen synthesis	Fatty acid synthesis	Glycogen synthesis
	Protein synthesis		Protein synthesis
Decreased by insulin	Ketogenesis	Lipolysis	
	Gluconeogenesis		
Increased by glucagon	Glycogenolysis	Lipolysis	
	Gluconeogenesis		
	Ketogenesis		

Other Hormones Affect Blood Glucose

The **anterior pituitary gland** secretes hormones that tend to elevate blood

glucose and therefore antagonize the action of insulin. These are growth hormone, adrenocorticotrophic hormone (ACTH), and possibly other “diabetogenic” hormones. Growth hormone secretion is stimulated by hypoglycemia; it decreases glucose uptake in muscle. Some of this effect may be indirect, since it stimulates mobilization of nonesterified fatty acids from adipose tissue, which themselves inhibit glucose utilization. The **glucocorticoids** (11-oxysteroids) are secreted by the adrenal cortex, and are also synthesized in an unregulated manner in adipose tissue. They act to increase gluconeogenesis as a result of enhanced hepatic catabolism of amino acids, due to induction of aminotransferases (and other enzymes such as tryptophan dioxygenase) and key enzymes of gluconeogenesis. In addition, glucocorticoids inhibit the utilization of glucose in extrahepatic tissues. In all these actions, glucocorticoids act in a manner antagonistic to insulin. A number of **cytokines** secreted by macrophages infiltrating adipose tissue also have insulin antagonistic actions; together with glucocorticoids secreted by adipose tissue, this explains the insulin resistance that commonly occurs in obese people.

Epinephrine is secreted by the adrenal medulla as a result of stressful stimuli (fear, excitement, hemorrhage, hypoxia, hypoglycemia, etc.) and leads to glycogenolysis in liver and muscle owing to stimulation of phosphorylase via generation of cAMP. In muscle, glycogenolysis results in increased glycolysis, whereas in liver, it results in the release of glucose into the bloodstream.

FURTHER CLINICAL ASPECTS

Glucosuria Occurs When the Renal Threshold for Glucose Is Exceeded

When the blood glucose concentration rises above about 10 mmol/L, the kidney also exerts a (passive) regulatory effect. Glucose is continuously filtered by the glomeruli, but is normally completely reabsorbed in the renal tubules by active transport. The capacity of the tubular system to reabsorb glucose is limited to a rate of about 2 mmol/min, and in hyperglycemia (as occurs in poorly controlled diabetes mellitus), the glomerular filtrate may contain more glucose than can be reabsorbed, resulting in **glucosuria** when the **renal threshold** for glucose is exceeded.

Hypoglycemia May Occur During Pregnancy & in the

Neonate

During pregnancy, fetal glucose consumption increases and there is a risk of maternal, and possibly fetal, hypoglycemia, particularly if there are long intervals between meals or at night. Furthermore, premature and low-birth-weight babies are more susceptible to hypoglycemia, since they have little adipose tissue to provide nonesterified fatty acids. The enzymes of gluconeogenesis may not be fully developed at this time, and gluconeogenesis is anyway dependent on a supply of nonesterified fatty acids for ATP formation. Little glycerol, which would normally be released from adipose tissue, is available for gluconeogenesis.

The Ability to Utilize Glucose May Be Ascertained by Measuring Glucose Tolerance

Glucose tolerance is the ability to regulate the blood glucose concentration after the administration of a test dose of glucose (normally 1 g/kg body weight) (**Figure 19–7**).

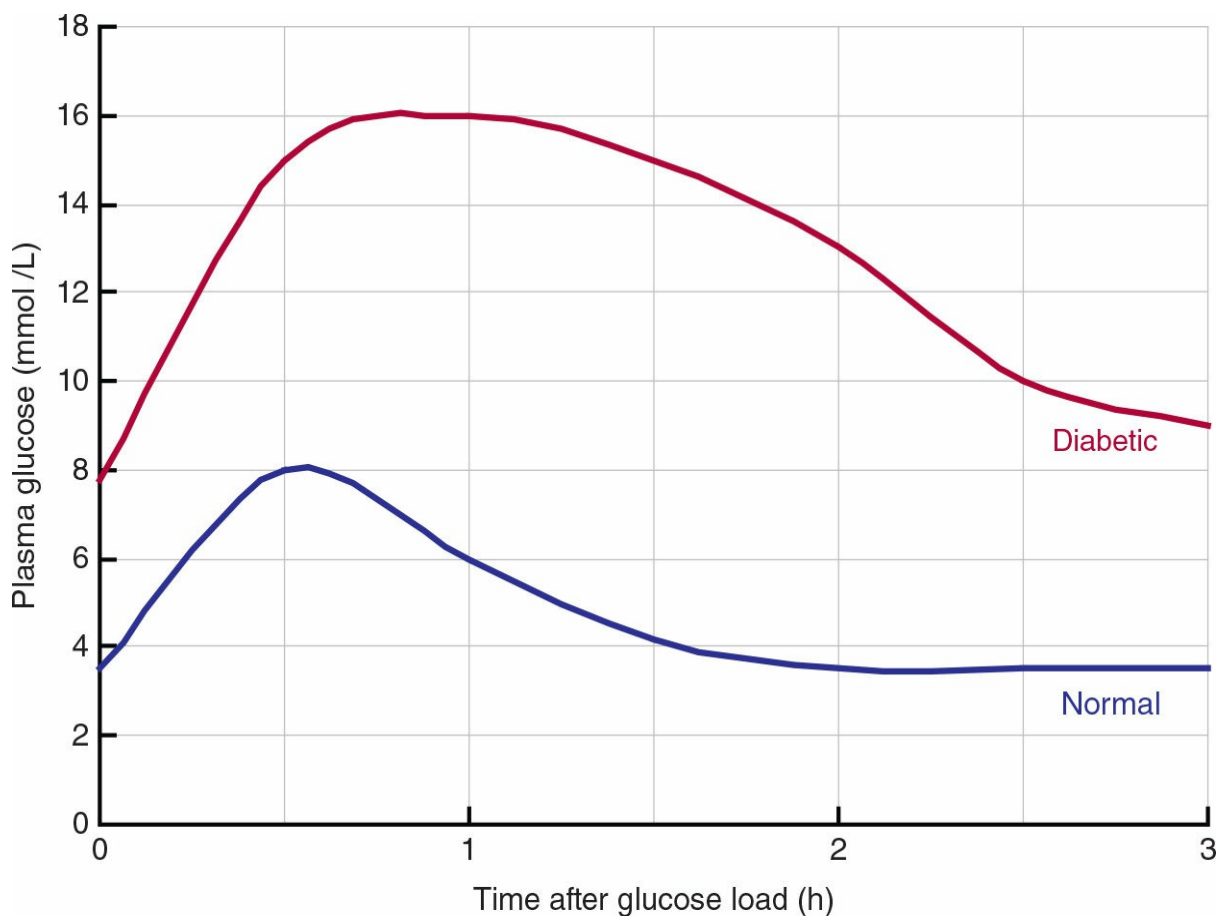

FIGURE 19–7 Glucose tolerance test. Blood glucose curves of a normal

and a diabetic person after oral administration of 1 g of glucose/kg body weight. Note the initial raised concentration in the fasting diabetic. A criterion of normality is the return to the initial value within 2 hours.

Diabetes mellitus (type 1, or insulin-dependent diabetes mellitus [IDDM]) is characterized by impaired glucose tolerance as a result of decreased secretion of insulin because of progressive destruction of pancreatic β -islet cells. Glucose tolerance is also impaired in type 2 diabetes mellitus (noninsulin-dependent diabetes [NIDDM]) as a result of reduced sensitivity of tissues to insulin action. Insulin resistance associated with obesity (and especially abdominal obesity) leading to the development of hyperlipidemia, then atherosclerosis and coronary heart disease, as well as overt diabetes, is known as the **metabolic syndrome**. Impaired glucose tolerance also occurs in conditions where the liver is damaged, in some infections, and in response to some drugs, as well as in conditions that lead to hyperactivity of the pituitary gland or adrenal cortex because of the hormones secreted by these glands that antagonize the action of insulin.

Administration of insulin (as in the treatment of diabetes mellitus) lowers the blood glucose concentration and increases its utilization and storage in the liver and muscle as glycogen. An excess of insulin may cause **hypoglycemia**, resulting in convulsions and even death unless glucose is administered promptly. Increased tolerance to glucose is observed in pituitary or adrenocortical insufficiency, attributable to a decrease in the antagonism to insulin by the hormones normally secreted by these glands.

The Energy Cost of Gluconeogenesis Explains Why Very Low Carbohydrate Diets Promote Weight Loss

Very low carbohydrate diets, providing only 20 g per day of carbohydrate or less (compared with a desirable intake of 100-120 g/day), but permitting unlimited consumption of fat and protein, have been promoted as an effective regime for weight loss, although such diets are counter to all advice on a prudent diet for health. Since there is a continual demand for glucose, there will be a considerable amount of gluconeogenesis from amino acids; the associated high ATP cost must then be met by oxidation of fatty acids.

SUMMARY

- Gluconeogenesis is the process of synthesizing glucose or glycogen from noncarbohydrate precursors. It is of particular importance when carbohydrate is not available from the diet. The main substrates are amino acids, lactate, glycerol, and propionate.
- The pathway of gluconeogenesis in the liver and kidney utilizes those reactions in glycolysis that are reversible plus four additional reactions that circumvent the irreversible nonequilibrium reactions.
- Since glycolysis and gluconeogenesis share the same pathway but operate in opposite directions, their activities must be regulated reciprocally.
- The liver regulates the blood glucose concentration after a meal because it contains the high K_m glucokinase that promotes increased hepatic utilization of glucose.
- Insulin is secreted as a direct response to hyperglycemia; it stimulates the liver to store glucose as glycogen and increases uptake of glucose into extrahepatic tissues.
- Glucagon is secreted as a response to hypoglycemia and activates both glycogenolysis and gluconeogenesis in the liver, causing release of glucose into the blood.

The Pentose Phosphate Pathway & Other Pathways of Hexose Metabolism

David A. Bender, PhD & Peter A. Mayes, PhD, DSc

OBJECTIVES

After studying this chapter, you should be able to:

- Describe the pentose phosphate pathway and its roles as a source of NADPH and of ribose for nucleotide synthesis.
- Describe the uronic acid pathway and its importance for synthesis of glucuronic acid for conjugation reactions and (in animals for which it is not a vitamin) vitamin C.
- Describe and explain the consequences of large intakes of fructose.
- Describe the synthesis and physiological importance of galactose.
- Explain the consequences of genetic defects of glucose-6-phosphate dehydrogenase (favism), the uronic acid pathway (essential pentosuria), and fructose and galactose metabolism.

BIOMEDICAL IMPORTANCE

The pentose phosphate pathway is an alternative route for the metabolism of glucose. It does not lead to formation of ATP but has two major functions: (1) the formation of **NADPH** for synthesis of fatty acids (see [Chapter 23](#)) and steroids (see [Chapter 26](#)), and maintaining reduced glutathione for antioxidant activity, and (2) the synthesis of **ribose** for nucleotide and nucleic acid formation (see [Chapter 32](#)). Glucose, fructose, and galactose are the main hexoses absorbed from the gastrointestinal tract, derived from dietary starch, sucrose, and lactose, respectively. Fructose and galactose can be converted to glucose, mainly in the liver.

Genetic deficiency of **glucose-6-phosphate dehydrogenase**, the first enzyme of the pentose phosphate pathway, causes acute hemolysis of red blood cells, resulting in **hemolytic anemia**. Glucuronic acid is synthesized from glucose via the **uronic acid pathway**, of minor quantitative importance, but of major significance for the conjugation and excretion of metabolites and foreign chemicals (xenobiotics, see [Chapter 47](#)) as **glucuronides**. A deficiency in the pathway leads to the condition of **essential pentosuria**. The lack of one enzyme of the pathway (gulonolactone oxidase) in primates and some other animals explains why **ascorbic acid** (vitamin C, see [Chapter 44](#)) is a dietary requirement for human beings but not most other mammals. Deficiencies in the enzymes of fructose and galactose metabolism lead to metabolic diseases such as **essential fructosuria, hereditary fructose intolerance, and galactosemia**.

THE PENTOSE PHOSPHATE PATHWAY FORMS NADPH & RIBOSE PHOSPHATE

The pentose phosphate pathway (hexose monophosphate shunt, [Figure 20–1](#)) is a more complex pathway than glycolysis (see [Chapter 17](#)). Three molecules of glucose-6-phosphate give rise to three molecules of CO₂ and three five-carbon sugars. These are rearranged to regenerate two molecules of glucose-6-phosphate and one molecule of the glycolytic intermediate, glyceraldehyde-3-phosphate. Since two molecules of glyceraldehyde-3-phosphate can regenerate glucose-6-phosphate, the pathway can account for the complete oxidation of glucose.

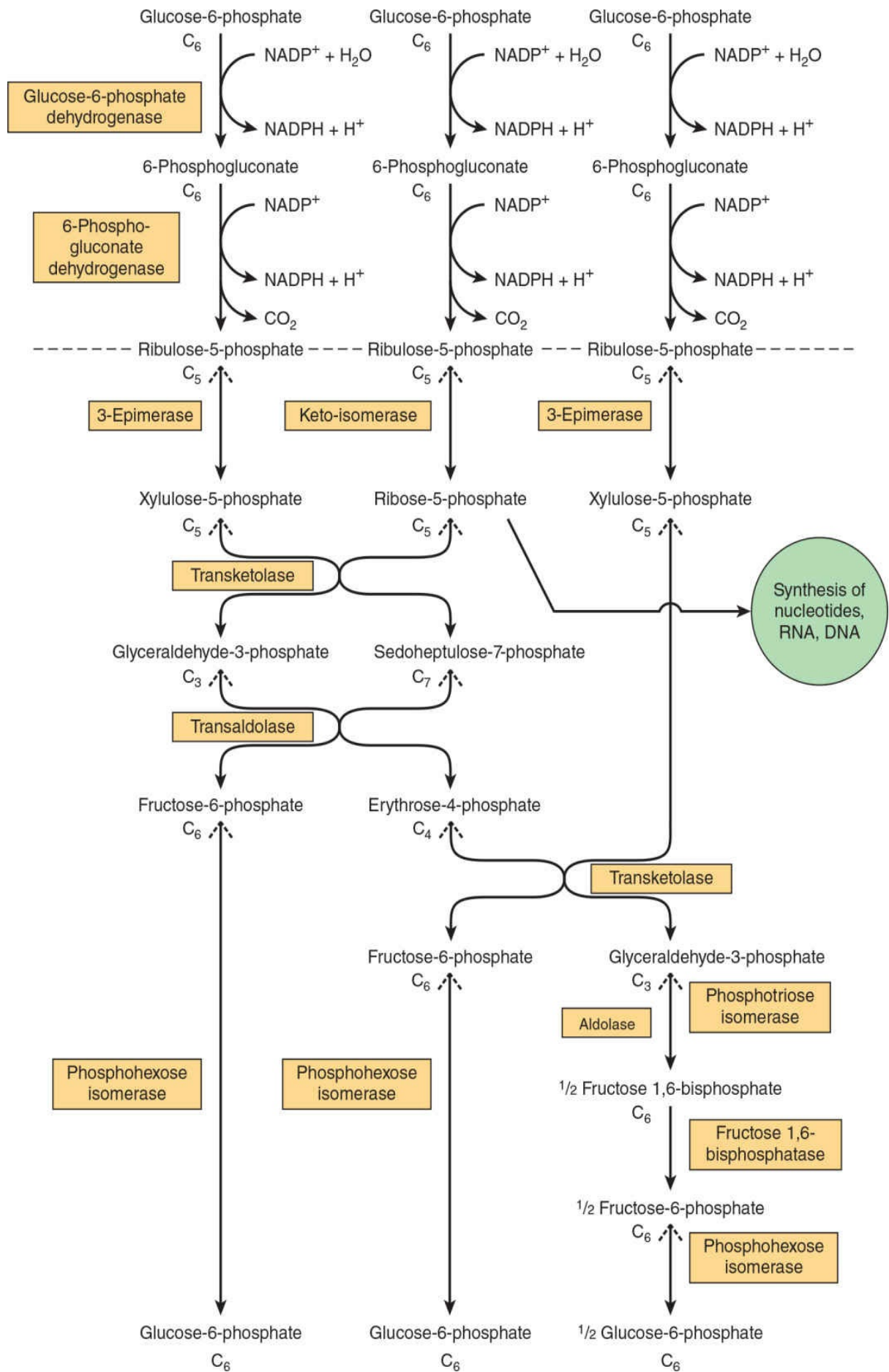

FIGURE 20–1 Flowchart of pentose phosphate pathway and its connections with the pathway of glycolysis. The full pathway, as indicated, consists of three interconnected cycles in which glucose-6-phosphate is both substrate and end product. The reactions above the broken line are nonreversible, whereas all reactions under that line are freely reversible apart from that catalyzed by fructose 1,6-bisphosphatase.

REACTIONS OF THE PENTOSE PHOSPHATE PATHWAY OCCUR IN THE CYTOSOL

Like glycolysis, the enzymes of the pentose phosphate pathway are cytosolic. Unlike glycolysis, oxidation is achieved by dehydrogenation using NADP^+ , not NAD^+ , as the hydrogen acceptor. The sequence of reactions of the pathway may be divided into two phases: an **irreversible oxidative phase** and a **reversible nonoxidative phase**. In the first phase, glucose-6-phosphate undergoes dehydrogenation and decarboxylation to yield a pentose, ribulose-5-phosphate. In the second phase, ribulose-5-phosphate is converted back to glucose-6-phosphate by a series of reactions involving mainly two enzymes: **transketolase** and **transaldolase** (Figure 20–1).

The Oxidative Phase Generates NADPH

Dehydrogenation of glucose-6-phosphate to 6-phosphogluconate occurs via the formation of 6-phosphogluconolactone, catalyzed by **glucose-6-phosphate dehydrogenase**, an NADP-dependent enzyme (Figures 20–1 and 20–2). The hydrolysis of 6-phosphogluconolactone is accomplished by the enzyme **gluconolactone hydrolase**. A second oxidative step is catalyzed by **6-phosphogluconate dehydrogenase**, which also requires NADP^+ as hydrogen acceptor. Decarboxylation forms the ketopentose ribulose-5-phosphate.

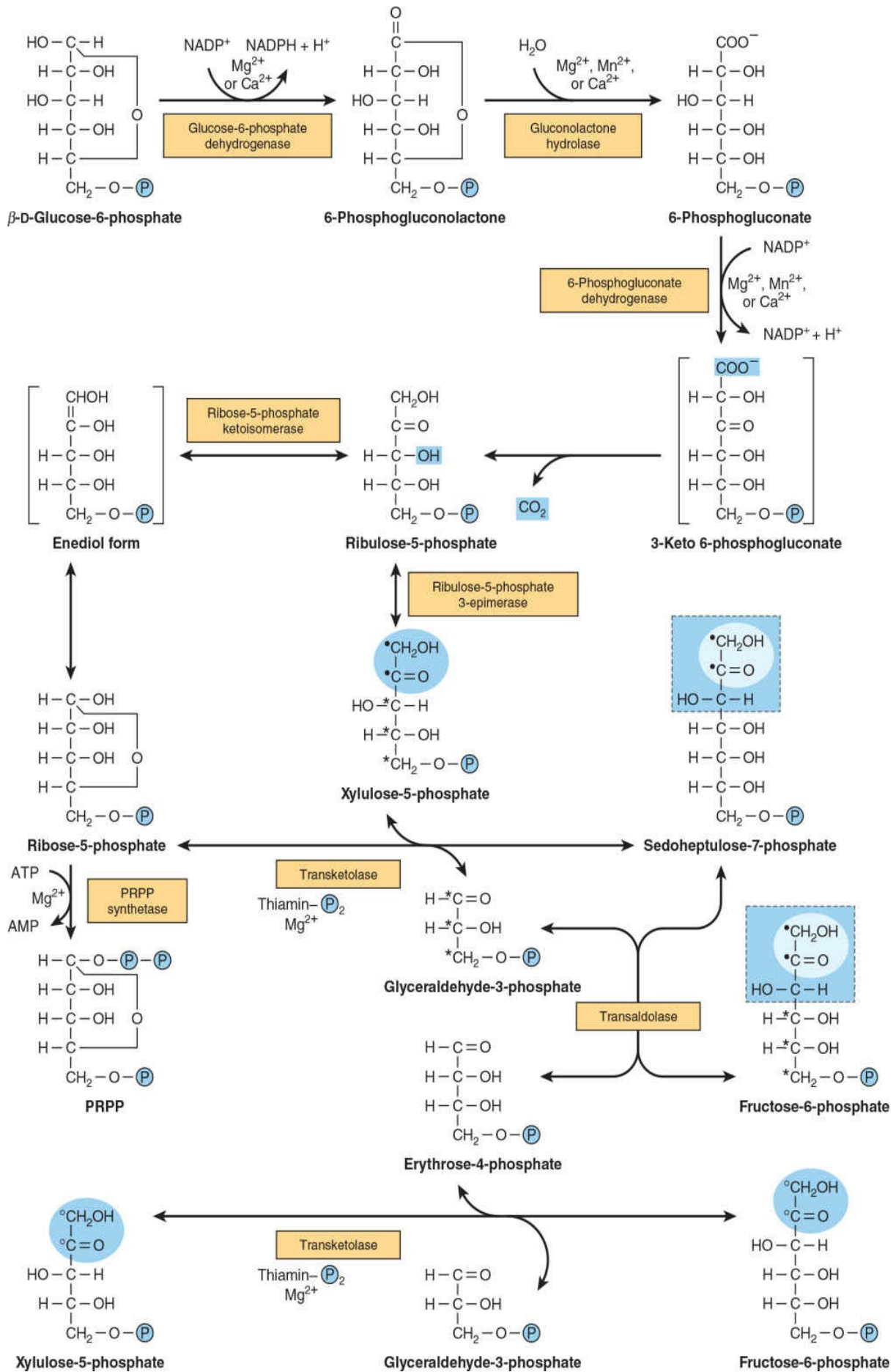

FIGURE 20–2 The pentose phosphate pathway. (P, $-\text{PO}_3^{2-}$; PRPP, 5-phosphoribosyl 1-pyrophosphate.)

In the endoplasmic reticulum, an isoenzyme of glucose-6-phosphate dehydrogenase, hexose-6-phosphate dehydrogenase, provides NADPH for hydroxylation (mixed function oxidase) reactions, and also for 11- β -hydroxysteroid dehydrogenase-1. This enzyme catalyzes the reduction of (inactive) cortisone to (active) cortisol in liver, the nervous system, and adipose tissue. It is the major source of intracellular cortisol in these tissues and may be important in obesity and the metabolic syndrome.

The Nonoxidative Phase Generates Ribose Precursors

Ribulose-5-phosphate is the substrate for two enzymes. **Ribulose-5-phosphate 3-epimerase** alters the configuration about carbon 3, forming the epimer xylulose 5-phosphate, also a ketopentose. **Ribose-5-phosphate ketoisomerase** converts ribulose-5-phosphate to the corresponding aldopentose, ribose-5-phosphate, which is used for nucleotide and nucleic acid synthesis. **Transketolase** transfers the two-carbon unit comprising carbons 1 and 2 of a ketose onto the aldehyde carbon of an aldose sugar. It therefore effects the conversion of a ketose sugar into an aldose with two carbons less and an aldose sugar into a ketose with two carbons more. The reaction requires Mg^{2+} and **thiamin diphosphate** (vitamin B₁) as coenzyme. Measurement of erythrocyte transketolase and its activation by thiamin diphosphate provides an index of vitamin B₁ nutritional status (see [Chapter 44](#)). The two-carbon moiety is transferred as glycolaldehyde bound to thiamin diphosphate. Thus, transketolase catalyzes the transfer of the two-carbon unit from xylulose 5-phosphate to ribose-5-phosphate, producing the seven-carbon ketose sedoheptulose-7-phosphate and the aldose glyceraldehyde-3-phosphate. These two products then undergo transaldolation. **Transaldolase** catalyzes the transfer of a three-carbon dihydroxyacetone moiety (carbons 1–3) from the ketose sedoheptulose-7-phosphate onto the aldose glyceraldehyde-3-phosphate to form the ketose fructose-6-phosphate and the four-carbon aldose erythrose-4-phosphate. Transaldolase has no cofactor, and the reaction proceeds via the intermediate formation of a Schiff base of dihydroxyacetone to the ϵ -amino group of a lysine residue in the enzyme. In a further reaction catalyzed by **transketolase**, xylulose 5-phosphate serves as a donor of glycolaldehyde. In this case, erythrose-4-phosphate is the acceptor, and the

products of the reaction are fructose-6-phosphate and glyceraldehyde-3-phosphate.

In order to oxidize glucose completely to CO_2 via the pentose phosphate pathway, there must be enzymes present in the tissue to convert glyceraldehyde-3-phosphate to glucose-6-phosphate. This involves reversal of glycolysis and the gluconeogenic enzyme **fructose 1,6-bisphosphatase**. In tissues that lack this enzyme, glyceraldehyde-3-phosphate follows the normal pathway of glycolysis to pyruvate.

The Two Major Pathways for the Catabolism of Glucose Have Little in Common

Although glucose-6-phosphate is common to both pathways, the pentose phosphate pathway is markedly different from glycolysis. Oxidation utilizes NADP^+ rather than NAD^+ , and CO_2 , which is not produced in glycolysis, is produced. No ATP is generated in the pentose phosphate pathway, whereas it is a product of glycolysis.

The two pathways are, however, connected. Xylulose 5-phosphate activates the protein phosphatase that dephosphorylates the 6-phosphofructo-2-kinase/fructose 2,6-bisphosphatase bifunctional enzyme (see [Chapter 17](#)). This activates the kinase and inactivates the phosphatase, leading to increased formation of fructose 2,6-bisphosphate, increased activity of phosphofructokinase-1, and hence increased glycolytic flux. Xylulose 5-phosphate also activates the protein phosphatase that initiates the nuclear translocation and DNA binding of the carbohydrate response element-binding protein, leading to increased synthesis of fatty acids (see [Chapter 23](#)) in response to a high-carbohydrate diet.

Reducing Equivalents Are Generated in Those Tissues Specializing in Reductive Syntheses

The pentose phosphate pathway is active in liver, adipose tissue, adrenal cortex, thyroid, erythrocytes, testis, and lactating mammary gland. Its activity is low in nonlactating mammary gland and skeletal muscle. Those tissues in which the pathway is active use NADPH in reductive syntheses, for example, of fatty acids, steroids, amino acids via glutamate dehydrogenase, and reduced glutathione. The synthesis of glucose-6-phosphate dehydrogenase and 6-phosphogluconate dehydrogenase may also be induced by insulin in the fed state, when lipogenesis increases.

Ribose Can Be Synthesized in Virtually All Tissues

Little or no ribose circulates in the bloodstream, so tissues have to synthesize the ribose they require for nucleotide and nucleic acid synthesis using the pentose phosphate pathway (Figure 20–2). It is not necessary to have a completely functioning pentose phosphate pathway for a tissue to synthesize ribose-5-phosphate. Muscle has only low activity of glucose-6-phosphate dehydrogenase and 6-phosphogluconate dehydrogenase, but, like most other tissues, it is capable of synthesizing ribose-5-phosphate by reversal of the nonoxidative phase of the pentose phosphate pathway utilizing fructose-6-phosphate.

THE PENTOSE PHOSPHATE PATHWAY & GLUTATHIONE PEROXIDASE PROTECT ERYTHROCYTES AGAINST HEMOLYSIS

In red blood cells, the pentose phosphate pathway is the sole source of NADPH for the reduction of oxidized glutathione catalyzed by **glutathione reductase**, a flavoprotein containing flavin adenine dinucleotide (FAD). Reduced glutathione removes H_2O_2 in a reaction catalyzed by **glutathione peroxidase**, an enzyme that contains the **selenium** analog of cysteine (selenocysteine) at the active site (Figure 20–3). The reaction is important since accumulation of H_2O_2 may decrease the life span of the erythrocyte by causing oxidative damage to the cell membrane, leading to hemolysis. In other tissues, NADPH can also be generated by the reaction catalyzed by the malic enzyme.

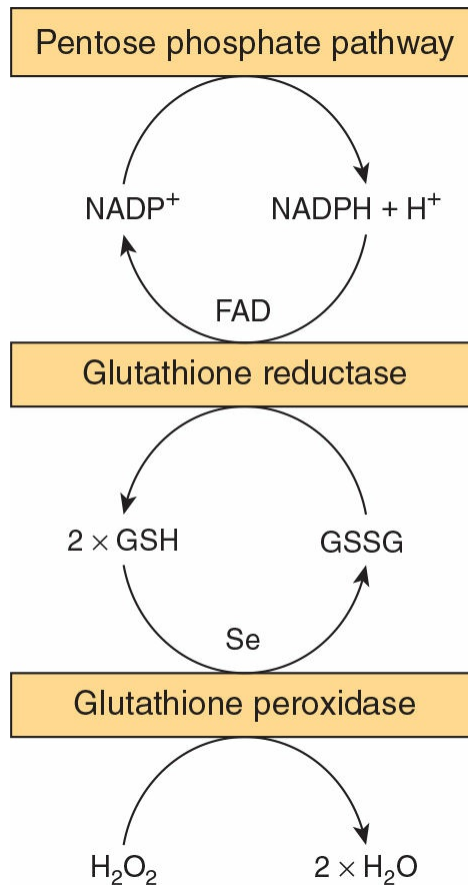
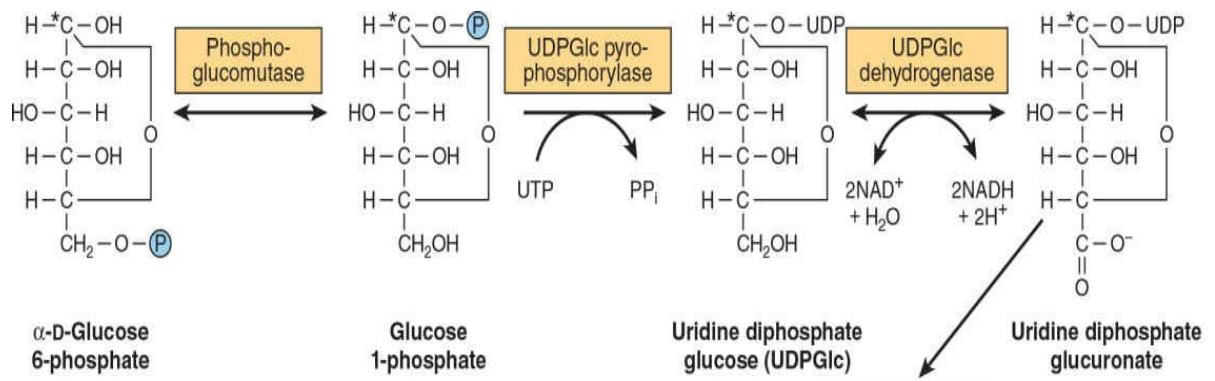

FIGURE 20–3 Role of the pentose phosphate pathway in the glutathione peroxidase reaction of erythrocytes. (GSH, reduced glutathione; GSSG, oxidized glutathione; Se, selenium-containing enzyme.)

GLUCURONATE, A PRECURSOR OF PROTEOGLYCANS & CONJUGATED GLUCURONIDES, IS A PRODUCT OF THE URONIC ACID PATHWAY

In liver, the **uronic acid pathway** catalyzes the conversion of glucose to glucuronic acid, ascorbic acid (except in human beings and other species for which ascorbate is a vitamin, vitamin C), and pentoses (**Figure 20–4**). It is also an alternative oxidative pathway for glucose that, like the pentose phosphate pathway, does not lead to the formation of ATP. Glucose-6-phosphate is isomerized to glucose-1-phosphate, which then reacts with uridine triphosphate (UTP) to form uridine diphosphate glucose (UDPGlc) in a reaction catalyzed by **UDPGlc pyrophosphorylase**, as occurs in glycogen synthesis (see **Chapter 18**). UDPGlc is oxidized at carbon 6 by

NAD-dependent **UDPGlc dehydrogenase** in a two-step reaction to yield UDP-glucuronate.



Glucuronides
Proteoglycans

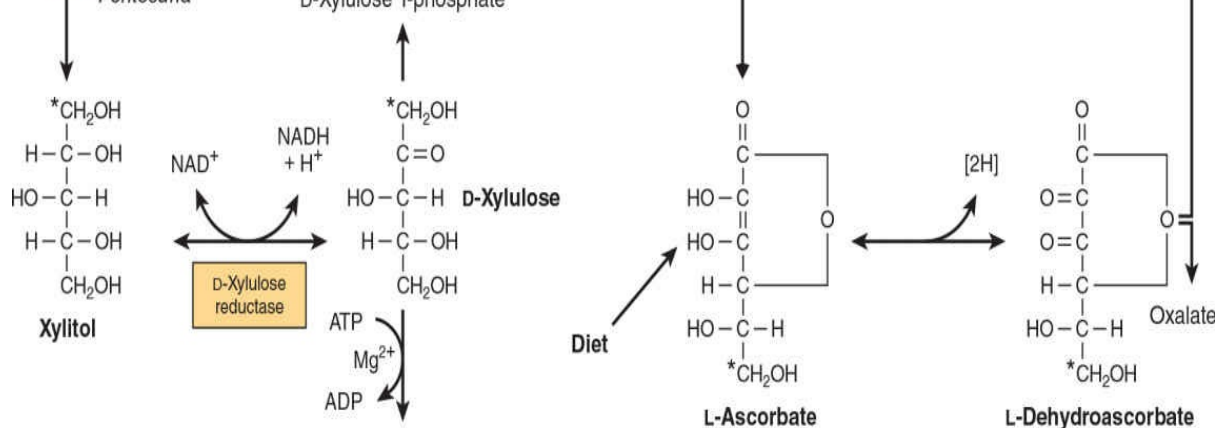
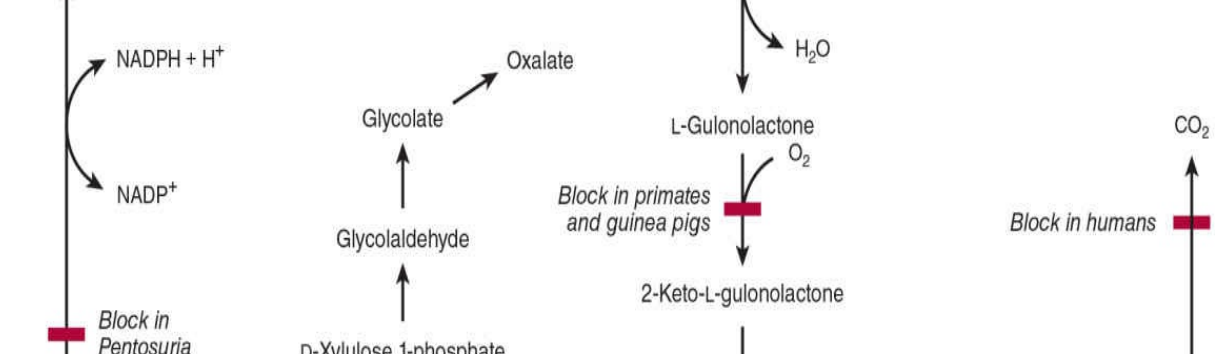
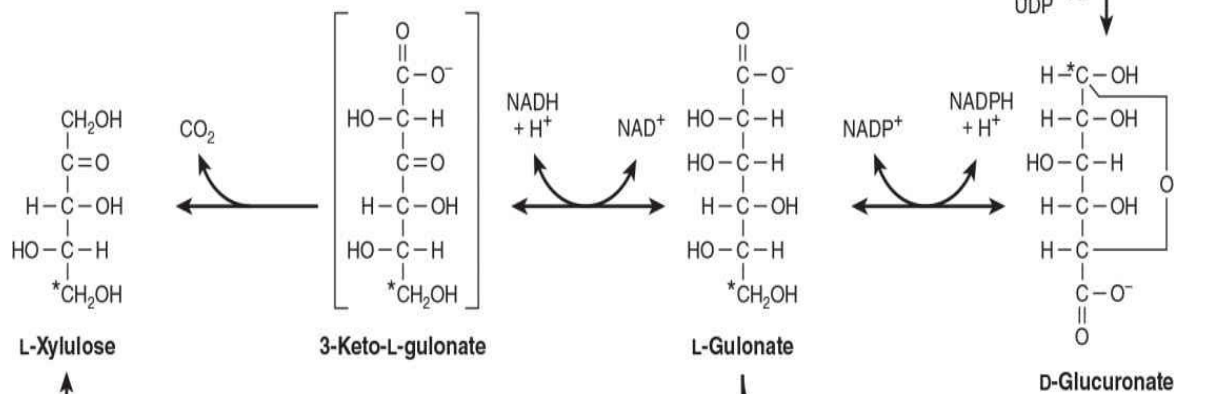
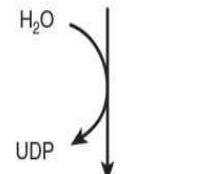

FIGURE 20–4 Uronic acid pathway. (*Indicates the fate of carbon 1 of glucose.)

UDP-glucuronate is the source of glucuronate for reactions involving its incorporation into proteoglycans (see [Chapter 46](#)) or for reaction with substrates such as steroid hormones, bilirubin, and a number of drugs that are excreted in urine or bile as glucuronide conjugates (see [Figure 31–13](#) and [Chapter 47](#)).

Glucuronate is reduced to L-gulonate, the direct precursor of **ascorbate** in those animals capable of synthesizing this vitamin, in an NADPH-dependent reaction. In human beings and other primates, as well as guinea pigs, bats, and some birds and fishes, ascorbic acid cannot be synthesized because of the absence of **L-gulonolactone oxidase**. L-Gulonate is oxidized to 3-keto-L-gulonate, which is then decarboxylated to L-xylulose. L-Xylulose is converted to the D-isomer by an NADPH-dependent reduction to xylitol, followed by oxidation in an NAD-dependent reaction to D-xylulose. After conversion to D-xylulose 5-phosphate, it is metabolized via the pentose phosphate pathway.

INGESTION OF LARGE QUANTITIES OF FRUCTOSE HAS PROFOUND METABOLIC CONSEQUENCES

Diets high in sucrose or in high-fructose syrups (HFS) used in manufactured foods and beverages lead to large amounts of fructose (and glucose) entering the hepatic portal vein.

Fructose undergoes more rapid glycolysis in the liver than does glucose because it bypasses the regulatory step catalyzed by phosphofructokinase ([Figure 20–5](#)). This allows fructose to flood the pathways in the liver, leading to increased fatty acid synthesis, esterification of fatty acids, and secretion of very-low-density lipoprotein (VLDL), which may raise serum triacylglycerols and ultimately raise LDL cholesterol concentrations.

Fructokinase in liver, kidney, and intestine catalyzes the phosphorylation of fructose to fructose-1-phosphate. This enzyme does not act on glucose, and, unlike glucokinase, its activity is not affected by fasting or by insulin, which may explain why fructose is cleared from the blood of diabetic patients at a normal rate. Fructose-1-phosphate is cleaved to D-glyceraldehyde and dihydroxyacetone phosphate by **aldolase B**, an enzyme found in the liver, which also functions in glycolysis in the liver

by cleaving fructose 1,6-bisphosphate. D-Glyceraldehyde enters glycolysis via phosphorylation to glyceraldehyde-3-phosphate catalyzed by **trio kinase**. The two triose phosphates, dihydroxyacetone phosphate, and glyceraldehyde-3-phosphate, may either be degraded by glycolysis or may be substrates for aldolase and hence gluconeogenesis, which is the fate of much of the fructose metabolized in the liver.

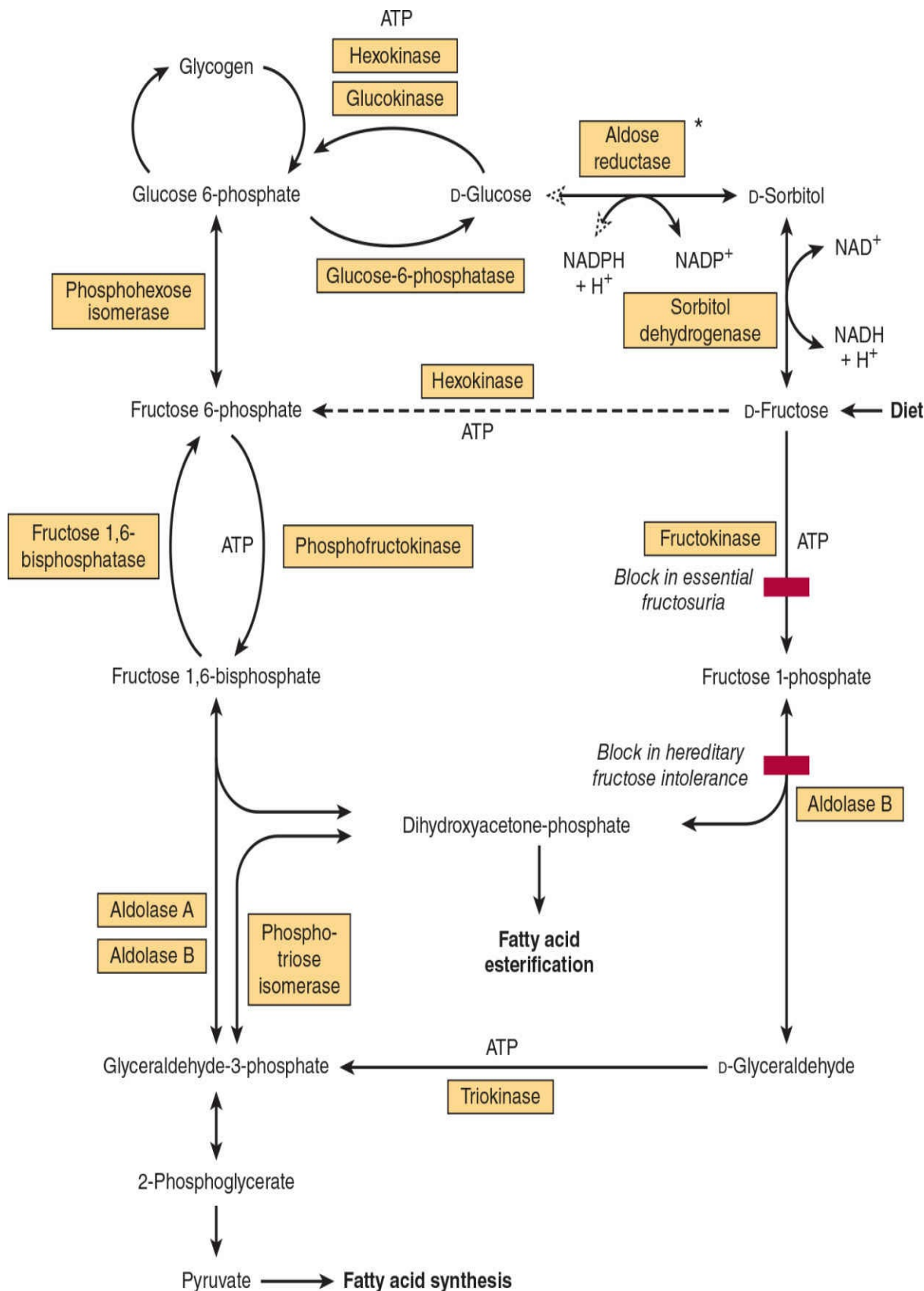

FIGURE 20-5 Metabolism of fructose. Aldolase A is found in all tissues, whereas aldolase B is the predominant form in liver. (*Not found

in liver.)

In extrahepatic tissues, hexokinase catalyzes the phosphorylation of most hexose sugars, including fructose, but glucose inhibits the phosphorylation of fructose since it is a better substrate for hexokinase. Nevertheless, some fructose can be metabolized in adipose tissue and muscle. Fructose is found in seminal plasma and in the fetal circulation of ungulates and whales. Aldose reductase is found in the placenta of the ewe and is responsible for the secretion of sorbitol into the fetal blood. The presence of sorbitol dehydrogenase in the liver, including the fetal liver, is responsible for the conversion of sorbitol into fructose. This pathway is also responsible for the occurrence of fructose in seminal fluid.

GALACTOSE IS NEEDED FOR THE SYNTHESIS OF LACTOSE, GLYCOLIPIDS, PROTEOGLYCANS, & GLYCOPROTEINS

Galactose is derived from intestinal hydrolysis of the disaccharide **lactose**, the sugar found in milk. It is readily converted in the liver to glucose.

Galactokinase catalyzes the phosphorylation of galactose, using ATP as phosphate donor (**Figure 20–6**). Galactose-1-phosphate reacts with UDPGlc to form uridine diphosphate galactose (UDPGal) and glucose-1-phosphate, in a reaction catalyzed by **galactose-1-phosphate uridyl transferase**. The conversion of UDPGal to UDPGlc is catalyzed by **UDPGal 4-epimerase**. The reaction involves oxidation, and then reduction, at carbon 4, with NAD^+ as a coenzyme. The UDPGlc is then incorporated into glycogen (see **Chapter 18**).

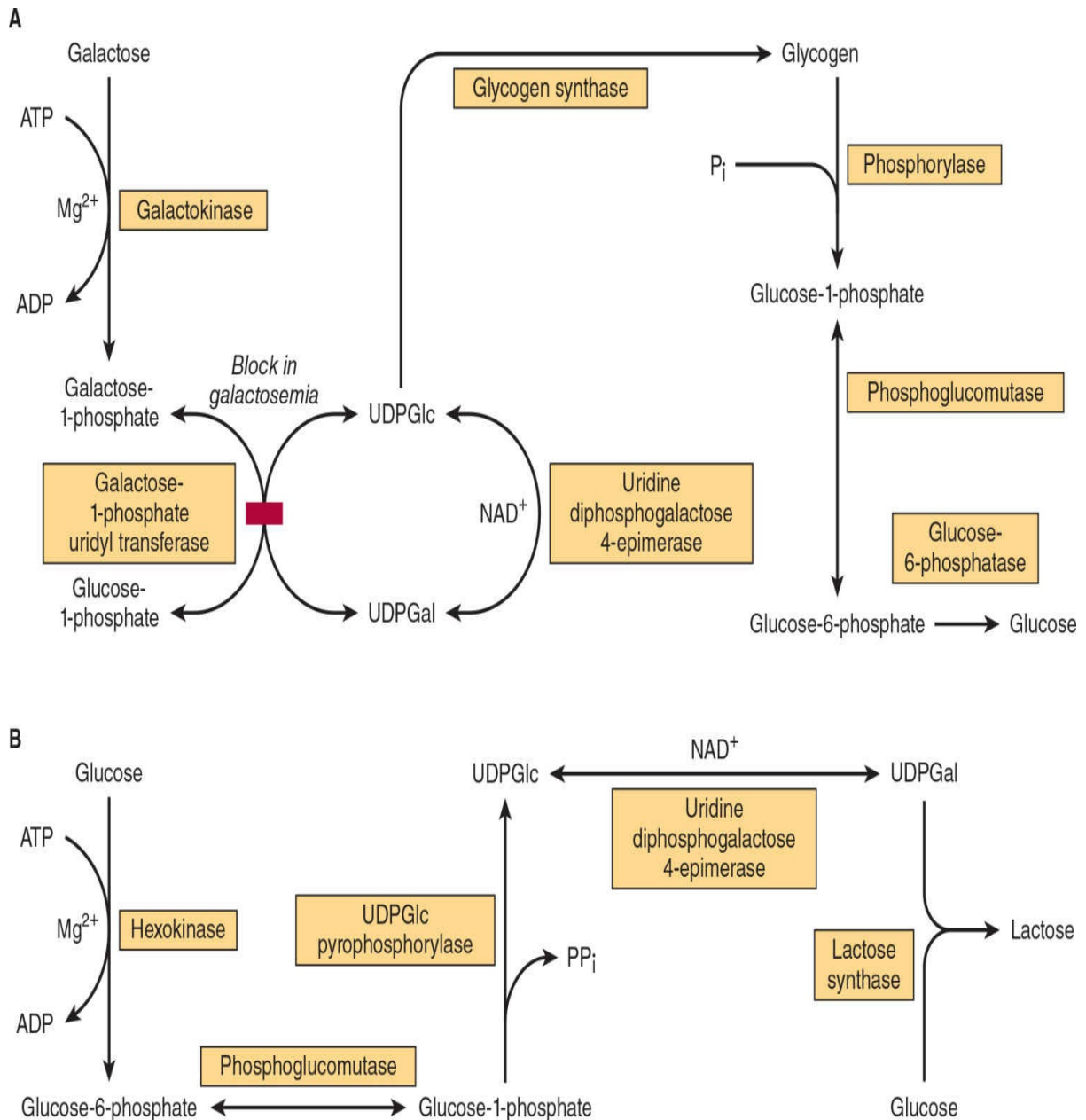

FIGURE 20–6 Pathway of conversion of (A) galactose to glucose in the liver and (B) glucose to lactose in the lactating mammary gland.

The epimerase reaction is freely reversible, so glucose can be converted to galactose, and galactose is not a dietary essential. Galactose is required in the body not only for the formation of lactose in lactation but also as a constituent of glycolipids (cerebrosides), proteoglycans, and glycoproteins. In the synthesis of lactose in the mammary gland, UDPGal condenses with glucose to yield lactose, catalyzed by **lactose synthase** (Figure 20–6).

Glucose Is the Precursor of Amino Sugars

(Hexosamines)

Amino sugars are important components of **glycoproteins** (see [Chapter 46](#)), of certain **glycosphingolipids** (eg, gangliosides; see [Chapter 21](#)), and of glycosaminoglycans (see [Chapter 50](#)). The major amino sugars are the hexosamines **glucosamine**, **galactosamine**, and **mannosamine**, and the nine-carbon compound **sialic acid**. The principal sialic acid found in human tissues is *N*-acetylneuraminic acid (NeuAc). A summary of the metabolic interrelationships among the amino sugars is shown in [Figure 20-7](#).

nucleotides may be similarly linked to sugars or amino sugars. Examples are thymidine diphosphate (TDP)-glucosamine and TDP-*N*-acetylglucosamine.

CLINICAL ASPECTS

Impairment of the Pentose Phosphate Pathway Leads to Erythrocyte Hemolysis

Genetic defects of glucose-6-phosphate dehydrogenase, with consequent impairment of the generation of NADPH, are common in populations of Mediterranean and Afro-Caribbean origin. The gene is on the X chromosome, so it is mainly males who are affected. Some 400 million people carry a mutated gene for glucose-6-phosphate dehydrogenase, making it the most common genetic defect, but most are asymptomatic. In some populations, glucose-6-phosphatase deficiency is common enough for it to be regarded as a genetic polymorphism. The distribution of mutant genes parallels that of malaria, suggesting that being heterozygous confers resistance against malaria. The defect is manifested as red cell hemolysis (**hemolytic anemia**) when susceptible individuals are subjected to oxidative stress (see [Chapter 45](#)) from infection, drugs such as the antimalarial primaquine, and sulfonamides, or when they have eaten fava beans (*Vicia faba*—hence the name of the disease, **favism**).

Many different mutations are known in the gene for glucose-6-phosphate dehydrogenase, leading to two main variants of favism. In the Afro-Caribbean variant, the enzyme is unstable, so that while average red-cell activities are low, it is only the older erythrocytes that are affected by oxidative stress, and the hemolytic crises tend to be self-limiting. By contrast, in the Mediterranean variant the enzyme is stable, but has low activity in all erythrocytes. Hemolytic crises in these people are more severe and can be fatal. Glutathione peroxidase is dependent on a supply of NADPH, which in erythrocytes can only be formed via the pentose phosphate pathway. It reduces organic peroxides and H_2O_2 as part of the body's defense against lipid peroxidation. Measurement of erythrocyte **glutathione reductase**, and its activation by FAD is used to assess **vitamin B₂** nutritional status (see [Chapter 44](#)).

Disruption of the Uronic Acid Pathway Is Caused by Enzyme Defects & Some Drugs

In the rare benign hereditary condition **essential pentosuria**, considerable quantities of **xylulose** appear in the urine, because of a lack of xylulose reductase, the enzyme necessary to reduce xylulose to xylitol. Although pentosuria is benign, with no clinical consequences, xylulose is a reducing sugar and can give false-positive results when urinary glucose is measured using alkaline copper reagents (see [Chapter 48](#)). Various drugs increase the rate at which glucose enters the uronic acid pathway. For example, administration of barbital or chlorobutanol to rats results in a significant increase in the conversion of glucose to glucuronate, L-gulonate, and ascorbate. Aminopyrine and antipyrine increase the excretion of xylulose in pentosuric subjects. Pentosuria also occurs after consumption of relatively large amounts of fruits such as pears that are rich sources of pentoses (**alimentary pentosuria**).

Loading of the Liver With Fructose May Potentiate Hypertriacylglycerolemia, Hypercholesterolemia, & Hyperuricemia

In the liver, fructose increases fatty acid and triacylglycerol synthesis and VLDL secretion, leading to hypertriacylglycerolemia—and increased LDL cholesterol—which can be regarded as potentially atherogenic (see [Chapter 26](#)). This is because fructose enters glycolysis via fructokinase, and the resulting fructose-1-phosphate bypasses the regulatory step catalyzed by phosphofructokinase (see [Chapter 17](#)). In addition, acute loading of the liver with fructose, as can occur with intravenous infusion or following very high fructose intakes, causes sequestration of inorganic phosphate in fructose-1-phosphate and diminished ATP synthesis. As a result, there is less inhibition of de novo purine synthesis by ATP, and uric acid formation is increased, causing hyperuricemia, which is the cause of **gout** (see [Chapter 33](#)). Since fructose is absorbed from the small intestine by (passive) carrier-mediated diffusion, high oral doses may lead to osmotic diarrhea.

Defects in Fructose Metabolism Cause Disease

A lack of hepatic fructokinase causes **essential fructosuria**, which is a benign and asymptomatic condition. The absence of aldolase B, which cleaves fructose-1-phosphate, leads to **hereditary fructose intolerance**, which is characterized by profound hypoglycemia and vomiting after consumption of fructose (or sucrose, which yields fructose on digestion).

Diets low in fructose, sorbitol, and sucrose are beneficial for both conditions. One consequence of hereditary fructose intolerance and of a related condition as a result of **fructose 1,6-bisphosphatase deficiency** is fructose-induced **hypoglycemia** despite the presence of high glycogen reserves, because fructose-1-phosphate and 1,6-bisphosphate allosterically inhibit liver glycogen phosphorylase. The sequestration of inorganic phosphate also leads to depletion of ATP and hyperuricemia.

Fructose & Sorbitol in the Lens Are Associated With Diabetic Cataract

Both fructose and sorbitol are found in the lens of the eye in increased concentrations in diabetes mellitus and may be involved in the pathogenesis of **diabetic cataract**. The **sorbitol (polyol) pathway** (not found in liver) is responsible for fructose formation from glucose (Figure 20–5) and increases in activity as the glucose concentration rises in those tissues that are not insulin-sensitive—the lens, peripheral nerves, and renal glomeruli. Glucose is reduced to sorbitol by **aldose reductase**, followed by oxidation of sorbitol to fructose in the presence of NAD^+ and sorbitol dehydrogenase (polyol dehydrogenase). Sorbitol does not diffuse through cell membranes, but accumulates, causing osmotic damage. Simultaneously, myoinositol levels fall. In experimental animals, sorbitol accumulation and myoinositol depletion, as well as diabetic cataract, can be prevented by aldose reductase inhibitors. A number of inhibitors are undergoing clinical trials for prevention of adverse effects of diabetes.

Enzyme Deficiencies in the Galactose Pathway Cause Galactosemia

Inability to metabolize galactose occurs in the **galactosemias**, which may be caused by inherited defects of galactokinase, uridyl transferase, or 4-epimerase (Figure 20–6A), though deficiency of **uridyl transferase** is best known. Galactose is a substrate for aldose reductase, forming galactitol, which accumulates in the lens of the eye, causing cataract. The condition is more severe if it is the result of a defect in the uridyl transferase since galactose-1-phosphate accumulates and depletes the liver of inorganic phosphate. Ultimately, liver failure and mental deterioration result. In uridyl transferase deficiency, the epimerase is present in adequate amounts, so that the galactosemic individual can still form UDPGal from glucose. This explains how it is possible for normal growth and

development of affected children to occur despite the galactose-free diets used to control the symptoms of the disease.

SUMMARY

- The pentose phosphate pathway, present in the cytosol, can account for the complete oxidation of glucose, producing NADPH and CO₂ but no ATP.
- The pathway has an oxidative phase, which is irreversible and generates NADPH, and a nonoxidative phase, which is reversible and provides ribose precursors for nucleotide synthesis. The complete pathway is present mainly in those tissues having a requirement for NADPH for reductive syntheses, for example, lipogenesis or steroidogenesis, whereas the nonoxidative phase is present in all cells requiring ribose.
- In erythrocytes, the pathway has a major function in preventing hemolysis by providing NADPH to maintain glutathione in the reduced state as the substrate for glutathione peroxidase.
- The uronic acid pathway is the source of glucuronic acid for conjugation of many endogenous and exogenous substances before excretion as glucuronides in urine and bile.
- Fructose bypasses the main regulatory step in glycolysis, catalyzed by phosphofructokinase, and stimulates fatty acid synthesis and hepatic triacylglycerol secretion.
- Galactose is synthesized from glucose in the lactating mammary gland and in other tissues where it is required for the synthesis of glycolipids, proteoglycans, and glycoproteins.

Exam Questions

Section IV – Metabolism of Carbohydrates

1. Which of the following is not a reducing sugar?
A. Erythrose

- B. Fructose
 - C. Galactose
 - D. Glucose
 - E. Ribose
2. Which of the following is the composition of sucrose?
- A. O- α -D-galactopyranosyl-(1 \rightarrow 4)- β -D-glucopyranose
 - B. O- α -D-glucopyranosyl-(1 \rightarrow 2)- β -D-fructofuranoside
 - C. O- α -D-glucopyranosyl-(1 \rightarrow 4)- α -D-glucopyranose
 - D. O- α -D-glucopyranosyl-(1 \rightarrow 1)- α -D-glucopyranoside
 - E. O- α -D-glucopyranosyl-(1 \rightarrow 6)- α -D-glucopyranose
3. Which of the following is not a pentose?
- A. Fructose
 - B. Ribose
 - C. Ribulose
 - D. Xylose
 - E. Xylulose
4. A blood sample is taken from a 50-year-old woman after an overnight fast. Which one of the following will be at a higher concentration than after she had eaten a meal?
- A. Glucose
 - B. Insulin
 - C. Ketone bodies
 - D. Nonesterified fatty acids
 - E. Triacylglycerol
5. A blood sample is taken from a 25-year-old man after he has eaten three slices of toast and a boiled egg. Which one of the following will be at a higher concentration than if the blood sample had been taken after an overnight fast?
- A. Alanine
 - B. Glucagon
 - C. Glucose
 - D. Ketone bodies
 - E. Nonesterified fatty acids

6. A blood sample is taken from a 40-year-old man who has been fasting completely for a week, drinking only water. Which of the following will be at a higher concentration than after a normal overnight fast?
- A. Glucose
 - B. Insulin
 - C. Ketone bodies
 - D. Nonesterified fatty acids
 - E. Triacylglycerol
7. Which one of the following statements about the fed and fasting metabolic states is correct?
- A. In the fasting state glucagon acts to increase the activity of lipoprotein lipase in adipose tissue.
 - B. In the fasting state, glucagon acts to increase the synthesis of glycogen from glucose.
 - C. In the fed state insulin acts to increase the breakdown of glycogen to maintain blood glucose.
 - D. In the fed state there is decreased secretion of insulin in response to increased glucose in the portal blood.
 - E. Ketone bodies are synthesized in liver in the fasting state, and the amount synthesized increases as fasting extends into starvation.
8. Which one of the following statements about the fed and fasting metabolic states is correct?
- A. In the fed state muscle can take up glucose for use as a metabolic fuel because glucose transport in muscle is stimulated in response to glucagon.
 - B. In the fed state there is decreased secretion of glucagon in response to increased glucose in the portal blood.
 - C. In the fed state, glucagon acts to increase the synthesis of glycogen from glucose.
 - D. Plasma glucose is maintained in starvation and prolonged fasting by gluconeogenesis from ketone bodies.
 - E. There is an increase in metabolic rate in the fasting state.
9. Which one of the following statements about the fed and fasting metabolic states is correct?

- A. In the fasting state muscle synthesizes glucose from amino acids.
 - B. In the fed state adipose tissue can take up glucose for synthesis of triacylglycerol because glucose transport in adipose tissue is stimulated in response to glucagon.
 - C. Ketone bodies are synthesized in muscle in the fasting state, and the amount synthesized increases as fasting extends into starvation.
 - D. Ketone bodies provide an alternative fuel for red blood cells in the fasting state.
 - E. Plasma glucose is maintained in starvation and prolonged fasting by gluconeogenesis from fatty acids.
10. Which one of following statements about the fed and fasting metabolic states is correct?
- A. In the fasting state adipose tissue synthesizes glucose from the glycerol released by the breakdown of triacylglycerol.
 - B. In the fasting state adipose tissue synthesizes ketone bodies.
 - C. In the fasting state the main fuel for red blood cells is fatty acids released from adipose tissue.
 - D. Ketone bodies provide the main fuel for the central nervous system in the fasting state.
 - E. Plasma glucose is maintained in starvation and prolonged fasting by gluconeogenesis in the liver from the amino acids released by the breakdown of muscle protein.
11. Which one of following statements about the fed and fasting metabolic states is correct?
- A. Fatty acids and triacylglycerol are synthesized in the liver in the fasting state.
 - B. In the fasting state the main fuel for the central nervous system is fatty acids released from adipose tissue.
 - C. In the fasting state the main metabolic fuel for most tissues comes from fatty acids released from adipose tissue.
 - D. In the fed state muscle cannot take up glucose for use as a metabolic fuel because glucose transport in muscle is stimulated in response to glucagon.
 - E. Plasma glucose is maintained in starvation and prolonged fasting by gluconeogenesis in adipose tissue from the glycerol released

from triacylglycerol.

12. A 25-year-old man visits his GP complaining of abdominal cramps and diarrhea after drinking milk. What is the most likely cause of his problem?
- A. Bacterial and yeast overgrowth in the large intestine
 - B. Infection with the intestinal parasite *Giardia lamblia*
 - C. Lack of pancreatic amylase
 - D. Lack of small intestinal lactase
 - E. Lack of small intestinal sucrase-isomaltase
13. Which one of following statements about glycolysis and gluconeogenesis is correct?
- A. All the reactions of glycolysis are freely reversible for gluconeogenesis.
 - B. Fructose cannot be used for gluconeogenesis in the liver because it cannot be phosphorylated to fructose-6-phosphate.
 - C. Glycolysis can proceed in the absence of oxygen only if pyruvate is formed from lactate in muscle.
 - D. Red blood cells only metabolize glucose by anaerobic glycolysis (and the pentose phosphate pathway).
 - E. The reverse of glycolysis is the pathway for gluconeogenesis in skeletal muscle.
14. Which one of following statements about the step in glycolysis catalyzed by hexokinase and in gluconeogenesis by glucose-6-phosphatase is correct?
- A. Because hexokinase has a low K_m , its activity in liver increases as the concentration of glucose in the portal blood increases.
 - B. Glucose-6-phosphatase is mainly active in muscle in the fasting state.
 - C. If hexokinase and glucose-6-phosphatase are both equally active at the same time, there is net formation of ATP from ADP and phosphate.
 - D. Liver contains an isoenzyme of hexokinase, glucokinase, which is especially important in the fed state.
 - E. Muscle can release glucose into the circulation from its glycogen reserves in the fasting state.

15. Which one of following statements about this step in glycolysis catalyzed by phosphofructokinase and in gluconeogenesis by fructose 1,6-bisphosphatase is correct?
- A. Fructose 1,6-bisphosphatase is mainly active in the liver in the fed state.
 - B. Fructose 1,6-bisphosphatase is mainly active in the liver in the fed state.
 - C. If phosphofructokinase and fructose 1,6-bisphosphatase are both equally active at the same time, there is a net formation of ATP from ADP and phosphate.
 - D. Phosphofructokinase is inhibited more or less completely by physiologic concentrations of ATP.
 - E. Phosphofructokinase is mainly active in the liver in the fasting state.
16. Which one of the following statements about glucose metabolism in maximum exertion is correct?
- A. Gluconeogenesis from lactate requires less ATP than is formed during anaerobic glycolysis.
 - B. In maximum exertion, pyruvate is oxidized to lactate in muscle.
 - C. Oxygen debt is caused by the need to exhale carbon dioxide produced in response to acidosis.
 - D. Oxygen debt reflects the need to replace oxygen that has been used in muscle during vigorous exercise.
 - E. There is metabolic acidosis as a result of vigorous exercise.
17. Which one of following statements is correct?
- A. Glucose-1-phosphate may be hydrolyzed to yield free glucose in liver.
 - B. Glucose-6-phosphate can be formed from glucose, but not from glycogen.
 - C. Glucose-6-phosphate cannot be converted to glucose-1-phosphate in liver.
 - D. Glucose-6-phosphate is formed from glycogen by the action of the enzyme glycogen phosphorylase.
 - E. In liver and red blood cells, glucose-6-phosphate may enter into either glycolysis or the pentose phosphate pathway.

18. Which one of following statements about the pyruvate dehydrogenase multienzyme complex is correct?
- A. In thiamin (vitamin B₁) deficiency, pyruvate formed in muscle cannot be transaminated to alanine.
 - B. In thiamin (vitamin B₁) deficiency, pyruvate formed in muscle cannot be carboxylated to oxaloacetate.
 - C. The reaction of pyruvate dehydrogenase involves decarboxylation and oxidation of pyruvate, then formation of acetyl-CoA.
 - D. The reaction of pyruvate dehydrogenase is readily reversible, so that acetyl-CoA can be used for the synthesis of pyruvate, and hence glucose.
 - E. The reaction of pyruvate dehydrogenase leads to the oxidation of NADH to NAD⁺, and hence the formation of $\sim 2.5 \times$ ATP per mol of pyruvate oxidized.
19. Which one of following statements about the pentose phosphate pathway is correct?
- A. In favism red blood cells are more susceptible to oxidative stress because of a lack of NADPH for fatty acid synthesis.
 - B. People who lack glucose-6-phosphate dehydrogenase cannot synthesize fatty acids because of a lack of NADPH in liver and adipose tissue.
 - C. The pentose phosphate pathway is especially important in tissues that are synthesizing fatty acids.
 - D. The pentose phosphate pathway is the only source of NADPH for fatty acid synthesis.
 - E. The pentose phosphate pathway provides an alternative to glycolysis only in the fasting state.
20. Which one of following statements about glycogen metabolism is correct?
- A. Glycogen is synthesized in the liver in the fed state, then exported to other tissues in low-density lipoproteins.
 - B. Glycogen reserves in liver and muscle will meet energy requirements for several days in prolonged fasting.
 - C. Liver synthesizes more glycogen when the hepatic portal blood concentration of glucose is high because of the activity of

- glucokinase in the liver.
- D. Muscle synthesizes glycogen in the fed state because glycogen phosphorylase is activated in response to insulin.
 - E. The plasma concentration of glycogen increases in the fed state.
21. Which one of following statements about gluconeogenesis is correct?
- A. Because they form acetyl-CoA, fatty acids can be a substrate for gluconeogenesis.
 - B. If oxaloacetate is withdrawn from the citric acid cycle for gluconeogenesis, then it can be replaced by the action of pyruvate dehydrogenase.
 - C. The reaction of phosphoenolpyruvate carboxykinase is important to replenish the pool of citric acid cycle intermediates.
 - D. The use of GTP as the phosphate donor in the phosphoenolpyruvate carboxykinase reaction provides a link between citric acid cycle activity and gluconeogenesis.
 - E. There is a greater yield of ATP in anaerobic glycolysis than the cost for synthesis of glucose from lactate.
22. Which one of following statements about carbohydrate metabolism is correct?
- A. A key step in the biosynthesis of glycogen is the formation of UDP-glucose.
 - B. Glycogen can be broken down to glucose-6-phosphate in muscle, which then releases free glucose by the action of the enzyme glucose-6-phosphatase.
 - C. Glycogen is stored mainly in the liver and brain.
 - D. Insulin inhibits the biosynthesis of glycogen.
 - E. Phosphorylase kinase is an enzyme that phosphorylates the enzyme glycogen phosphorylase and thereby decreases glycogen breakdown.
23. Which one of following statements about glycogen metabolism is correct?
- A. Glycogen synthase activity is increased by glucagon.
 - B. Glycogen phosphorylase is an enzyme that can be activated by phosphorylation of serine residues.
 - C. Glycogen phosphorylase cannot be activated by calcium ions.

- D. cAMP activates glycogen synthesis.
- E. Glycogen phosphorylase breaks the α 1-4 glycosidic bonds by hydrolysis.
24. Which one of following statements about glucose metabolism is correct?
- A. Glucagon increases the rate of glycolysis.
- B. Glycolysis requires NADP^+ .
- C. In glycolysis, glucose is cleaved into two three-carbon compounds.
- D. Substrate-level phosphorylation takes place in the electron transport system.
- E. The main product of glycolysis in red blood cells is pyruvate.
25. Which one of following statements about metabolism of sugars is correct?
- A. Fructokinase phosphorylates fructose to fructose-6-phosphate.
- B. Fructose is an aldose sugar-like glucose.
- C. Fructose transport into cells is insulin dependent.
- D. Galactose is phosphorylated to galactose-1-phosphate by galactokinase.
- E. Sucrose can be biosynthesized from glucose and fructose in the liver.
26. In glycolysis, the conversion of 1 mol of fructose 1,6-bisphosphate to 2 mol of pyruvate results in the formation of:
- A. 1 mol NAD^+ and 2 mol of ATP
- B. 1 mol NADH and 1 mol of ATP
- C. 2 mol NAD^+ and 4 mol of ATP
- D. 2 mol NADH and 2 mol of ATP
- E. 2 mol NADH and 4 mol of ATP
27. Which of the following will provide the main fuel for muscle contraction during short-term maximum exertion?
- A. Muscle glycogen
- B. Muscle reserves of triacylglycerol
- C. Plasma glucose
- D. Plasma nonesterified fatty acids

E. Triacylglycerol in plasma very-low-density lipoprotein

28. The disaccharide lactulose is not digested, but is fermented by intestinal bacteria, to yield 4 mol of lactate plus four protons. Ammonium (NH_4^+) is in equilibrium with ammonia (NH_3) in the bloodstream. Which of the following best explains how lactulose acts to treat hyperammonemia (elevated blood ammonium concentration)?
- A. Fermentation of lactulose increases the acidity of the bloodstream so that there is more ammonium and less ammonia is available to cross the gut wall.
 - B. Fermentation of lactulose results in acidification of the gut contents so that ammonia diffuses from the bloodstream into the gut and is trapped as ammonium that cannot cross back.
 - C. Fermentation of lactulose results in acidification of the gut contents so that ammonia produced by intestinal bacteria is trapped as ammonium that cannot diffuse into the bloodstream.
 - D. Fermentation of lactulose results in an eightfold increase in the osmolality of the gut contents, so that there is more water for ammonia and ammonium to dissolve in, so that less is absorbed into the bloodstream.
 - E. Fermentation of lactulose results in an eightfold increase in the osmolality of the gut contents, so that there is more water for ammonia and ammonium to dissolve in, so that more will diffuse for the bloodstream into the gut.

SECTION

V

Metabolism of Lipids

CHAPTER

21

Lipids of Physiologic Significance

Kathleen M. Botham, PhD, DSc & Peter A. Mayes, PhD, DSc

OBJECTIVES

After studying this chapter, you should be able to:

- Define simple and complex lipids and identify the lipid classes in each group.
- Indicate the structure of saturated and unsaturated fatty acids, explain how the chain length and degree of unsaturation influence their melting point, give examples, and explain the nomenclature.
- Explain the difference between *cis* and *trans* carbon–carbon double bonds.
- Describe how eicosanoids are formed by modification of the structure of unsaturated fatty acids; identify the various eicosanoid

classes and indicate their functions.

- Outline the general structure of triacylglycerols and indicate their function.
- Outline the general structure of phospholipids and glycosphingolipids and indicate the functions of the different classes.
- Appreciate the importance of cholesterol as the precursor of many biologically important steroids, including steroid hormones, bile acids, and vitamins D.
- Recognize the cyclic nucleus common to all steroids.
- Explain why free radicals are damaging to tissues and identify the three stages in the chain reaction of lipid peroxidation that produces them continuously.
- Describe how antioxidants protect lipids from peroxidation by either inhibiting chain initiation or breaking the chain.
- Recognize that many lipid molecules are amphipathic, having both hydrophobic and hydrophilic groups in their structure, and explain how this influences their behavior in an aqueous environment and enables certain classes, including phospholipids, sphingolipids, and cholesterol, to form the basic structure of biologic membranes.

BIOMEDICAL IMPORTANCE

The lipids are a heterogeneous group of compounds, including fats, oils, steroids, waxes, and related compounds, that are related more by their physical than by their chemical properties. They have the common property of being (1) relatively **insoluble in water** and (2) **soluble in nonpolar solvents** such as ether and chloroform. They are important dietary constituents not only because of the high energy value of fats but also because **essential fatty acids, fat-soluble vitamins**, and other lipophilic **micronutrients** are contained in the fat of natural foods. Dietary supplementation with **long-chain ω 3 fatty acids** is believed to have beneficial effects in a number of chronic diseases, including cardiovascular disease, rheumatoid arthritis, and dementia. Fat is stored in **adipose tissue**, where it also serves as a thermal insulator in the subcutaneous tissues and around certain organs. Nonpolar lipids act as **electrical insulators**, allowing rapid propagation of depolarization waves along **myelinated nerves**. Lipids are transported in the blood combined with proteins in **lipoprotein** particles (see [Chapters 25](#) and [26](#)). Lipids have essential roles

in nutrition and health and knowledge of lipid biochemistry is necessary for the understanding of many important biomedical conditions, including **obesity, diabetes mellitus, and atherosclerosis.**

LIPIDS ARE CLASSIFIED AS SIMPLE OR COMPLEX

- 1. Simple lipids** include fats and waxes which are esters of fatty acids with various alcohols:
 - a. Fats:** Esters of fatty acids with glycerol. **Oils** are fats in the liquid state.
 - b. Waxes:** Esters of fatty acids with higher molecular weight monohydric alcohols.
- 2. Complex lipids** are esters of fatty acids, which always contain an alcohol and one or more fatty acids, but which also have other groups. They can be divided into three types:
 - a. Phospholipids:** Contain a phosphoric acid residue. They frequently have nitrogen-containing bases (eg, choline) and other substituents. In many phospholipids the alcohol is glycerol (**glycerophospholipids**), but in **sphingophospholipids** it is sphingosine, which contains an amino group.
 - b. Glycolipids (glycosphingolipids):** Contain a fatty acid, sphingosine, and carbohydrate.
 - c. Other complex lipids:** These include lipids such as sulfolipids and amino lipids. Lipoproteins may also be placed in this category.
- 3. Derived lipids** are formed from the hydrolysis of both simple and complex lipids. They include **fatty acids**, glycerol, steroids, other alcohols, fatty aldehydes, ketone bodies (see [Chapter 22](#)), hydrocarbons, lipid-soluble vitamins and micronutrients, and hormones. Some of these (eg, free fatty acids, glycerol) also act as **precursor lipids** in the formation of simple and complex lipids.

Because they are uncharged, acylglycerols (glycerides), cholesterol, and cholesteryl esters are termed **neutral lipids.**

FATTY ACIDS ARE ALIPHATIC CARBOXYLIC ACIDS

Fatty acids occur in the body mainly as esters in natural fats and oils, but

are found in the unesterified form as **free fatty acids**, a transport form in the plasma. Fatty acids that occur in natural fats usually contain an even number of carbon atoms. The chain may be **saturated** (containing no double bonds) or **unsaturated** (containing one or more double bonds) (**Figure 21–1**).

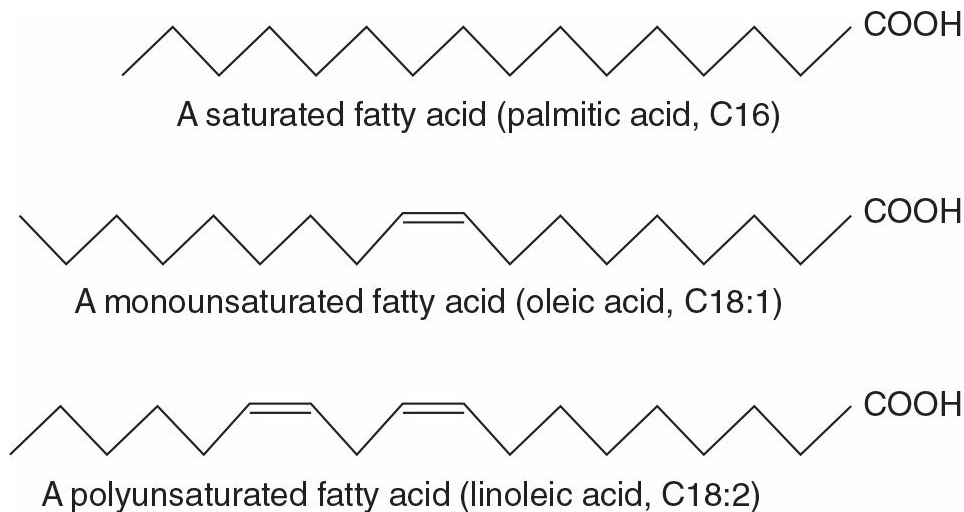

FIGURE 21–1 Fatty acids. Examples of a saturated (palmitic acid), monounsaturated (oleic acid), and a polyunsaturated (linoleic acid) fatty acid are shown.

Fatty Acids Are Named After Corresponding Hydrocarbons

The most frequently used systematic nomenclature names the fatty acid after the hydrocarbon with the same number and arrangement of carbon atoms, with **-oic** being substituted for the final **-e** (Genevan system). Thus, saturated acids end in **-anoic**, for example, octanoic acid (C8), and unsaturated acids with double bonds end in **-enoic**, for example, octadecenoic acid (oleic acid, C18).

Carbon atoms are numbered from the carboxyl carbon (carbon no. 1). The carbon atoms adjacent to the carboxyl carbon (nos. 2, 3, and 4) are also known as the α , β , and γ carbons, respectively, and the terminal methyl carbon is known as the ω - or n-carbon.

Various conventions use Δ for indicating the number and position of the double bonds (**Figure 21–2**); for example, Δ^9 indicates a double bond between carbons 9 and 10 of the fatty acid; $\omega 9$ indicates a double bond on the ninth carbon counting from the ω -carbon. In animals, additional double bonds can be introduced only between an existing double bond at the $\omega 9$,

Common Name	Number of C Atoms	Occurrence
Acetic	2	Major end product of carbohydrate fermentation by rumen organisms
Butyric	4	In certain fats in small amounts (especially butter). An end product of carbohydrate fermentation by rumen organisms ^a
Valeric	5	
Caproic	6	
Lauric	12	Spermaceti, cinnamon, palm kernel, coconut oils, laurels, butter
Myristic	14	Nutmeg, palm kernel, coconut oils, myrtles, butter
Palmitic	16	Common in all animal and plant fats
Stearic	18	

^aAlso formed in the cecum of herbivores and to a lesser extent in the colon of humans.

Unsaturated Fatty Acids Contain One or More Double Bonds

Unsaturated fatty acids (Figure 21–1, Table 21–2, for examples) may be further subdivided as follows:

TABLE 21–2 Unsaturated Fatty Acids of Physiologic and Nutritional Significance

Number of C Atoms and Number and Position of Common Double Bonds	Family	Common Name	Systematic Name	Occurrence
Monoenoic acids (one double bond)				
16:1;9	ω 7	Palmitoleic	<i>cis</i> -9-Hexadecenoic	In nearly all fats
18:1;9	ω 9	Oleic	<i>cis</i> -9-Octadecenoic	Possibly the most common fatty acid in natural fats; particularly high in olive oil
18:1;9	ω 9	Elaidic	<i>trans</i> -9-Octadecenoic	Hydrogenated and ruminant fats
Dienoic acids (two double bonds)				
18:2;9,12	ω 6	Linoleic	all- <i>cis</i> -9,12-Octadecadienoic	Corn, peanut, cottonseed, soy bean, and many plant oils
Trienoic acids (three double bonds)				
18:3;6,9,12	ω 6	γ -Linolenic	all- <i>cis</i> -6,9,12-Octadecatrienoic	Some plants, eg, oil of evening primrose, borage oil; minor fatty acid in animals
18:3;9,12,15	ω 3	α -Linolenic	all- <i>cis</i> -9,12,15-Octadecatrienoic	Frequently found with linoleic acid but particularly in linseed oil
Tetraenoic acids (four double bonds)				
20:4;5,8,11,14	ω 6	Arachidonic	all- <i>cis</i> -5,8,11,14-Eicosatetraenoic	Found in animal fats; important component of phospholipids in animals
Pentaenoic acids (five double bonds)				
20:5;5,8,11,14,17	ω 3	Timnodonic	all- <i>cis</i> -5,8,11,14,17-Eicosapentaenoic	Important component of fish oils, eg, cod liver, mackerel, menhaden, salmon oils
Hexaenoic acids (six double bonds)				
22:6;4,7,10,13,16,19	ω 3	Cervonic	all- <i>cis</i> -4,7,10,13,16,19-Docosahexaenoic	Fish oils, algal oils, phospholipids in brain

- 1. Monounsaturated** (monoethenoid, monoenoic) acids, containing one double bond.
- 2. Polyunsaturated** (polyethenoid, polyenoic) acids, containing two or more double bonds.
- 3. Eicosanoids:** These compounds, derived from eicosa (20-carbon) polyenoic fatty acids (see [Chapter 23](#)), comprise the **prostanoids**, **leukotrienes (LTs)**, and **lipoxins (LXs)**. Prostanoids include **prostaglandins (PGs)**, **prostacyclins (PGIs)**, and **thromboxanes**

(TXs).

Prostaglandins exist in virtually every mammalian tissue, acting as local hormones; they have important physiologic and pharmacologic activities. They are synthesized *in vivo* by cyclization of the center of the carbon chain of 20-carbon (eicosanoic) polyunsaturated fatty acids (eg, arachidonic acid) to form a cyclopentane ring (**Figure 21–3**). A related series of compounds, the **thromboxanes**, have the cyclopentane ring interrupted with an oxygen atom (oxane ring) (**Figure 21–4**). Three different eicosanoic fatty acids give rise to three groups of eicosanoids characterized by the number of double bonds in the side chains (see **Figure 23–12**), for example, prostaglandin (PG)₁, PG₂, and PG₃. Different substituent groups attached to the rings give rise to series of prostaglandins and thromboxanes labeled A, B, etc (see **Figure 23–13**)—for example, the “E” type of prostaglandin (as in PGE₂) has a keto group in position 9, whereas the “F” type has a hydroxyl group in this position. The **leukotrienes** and **lipoxins** (**Figure 21–5**) are a third group of eicosanoid derivatives formed via the **lipoxygenase pathway** (see **Figure 23–13**). They are characterized by the presence of three or four conjugated double bonds, respectively. Leukotrienes cause bronchoconstriction as well as being potent proinflammatory agents, and play a part in **asthma**.

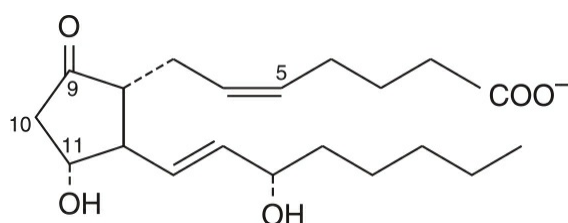

FIGURE 21–3 Prostaglandin E2 (PGE₂).

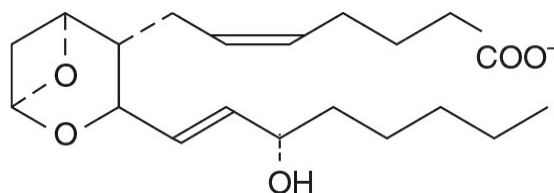

FIGURE 21–4 Thromboxane A2 (TXA₂).

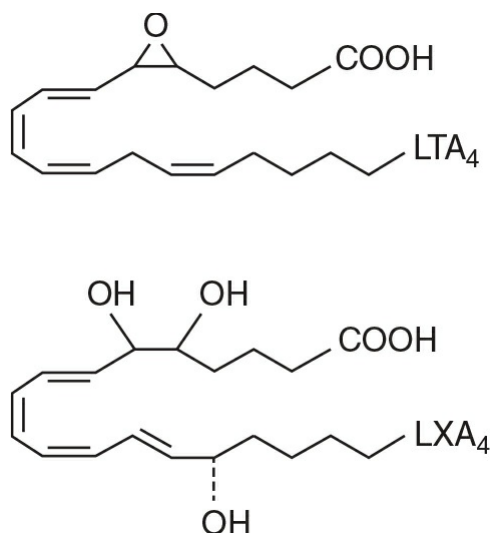

FIGURE 21–5 Leukotriene and lipoxin structure. Examples shown are leukotriene A₄ (LTA₄) and lipoxin A₄ (LXA₄).

Most Naturally Occurring Unsaturated Fatty Acids Have *cis* Double Bonds

The carbon chains of saturated fatty acids form a zigzag pattern when extended at low temperatures (Figure 21–1). At higher temperatures, some bonds rotate, causing chain shortening, which explains why biomembranes become thinner with increases in temperature. A type of **geometric isomerism** occurs in unsaturated fatty acids, depending on the orientation of atoms or groups around the axes of double bonds, which do not allow rotation. If the acyl chains are on the same side of the bond, it is ***cis***-, as in oleic acid; if on opposite sides, it is ***trans***-, as in elaidic acid, the *trans* isomer of oleic acid (Figure 21–6). Double bonds in naturally occurring unsaturated long-chain fatty acids are nearly all in the *cis* configuration, the molecules being “bent” 120° at the double bond. Thus, oleic acid has a V shape, whereas elaidic acid remains “straight.” Increase in the number of *cis* double bonds in a fatty acid leads to a variety of possible spatial configurations of the molecule—for example, arachidonic acid, with four *cis* double bonds, is bent into a U shape (Figure 21–7). This has profound significance for molecular packing in cell membranes (see Chapter 40) and on the positions occupied by fatty acids in more complex molecules such as phospholipids. *Trans* double bonds alter these spatial relationships. ***Trans* fatty acids** are present in certain foods, arising as a by-product of the saturation of fatty acids during hydrogenation, or “hardening,” of natural oils in the manufacture of margarine. An additional small

contribution comes from the ingestion of ruminant fat that contains *trans* fatty acids arising from the action of microorganisms in the rumen. Consumption of *trans* fatty acids is now known to be detrimental to health and is associated with increased risk of diseases including cardiovascular disease and diabetes mellitus. This has led to improved technology to produce soft margarine low in *trans* fatty acids or containing none at all.

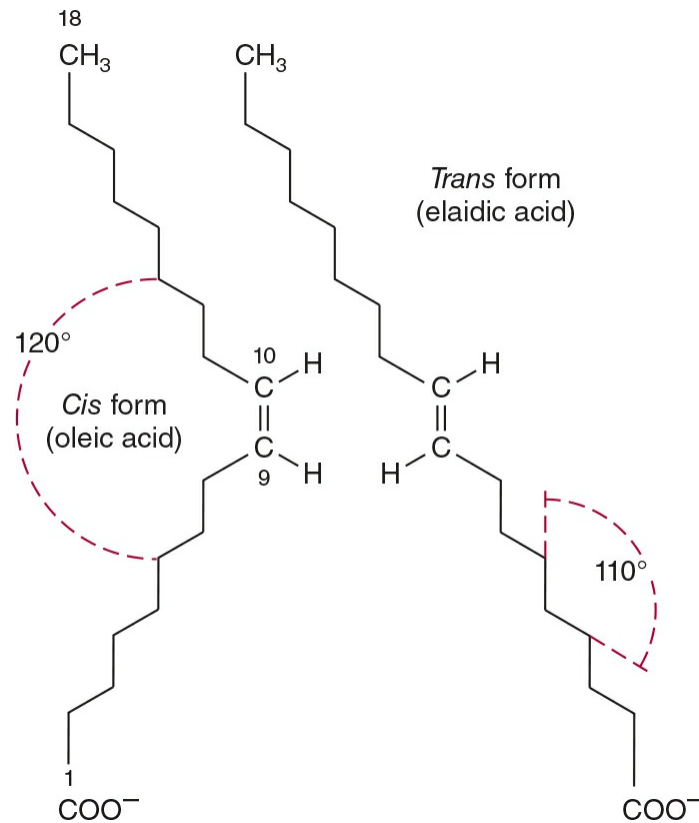

FIGURE 21–6 Geometric isomerism of Δ^9 , 18:1 fatty acids (oleic and elaidic acids). There is no rotation around carbon–carbon double bonds. In the *cis* configuration, the acyl chains are on the same side of the bond, while in *trans* form they are on opposite sides.

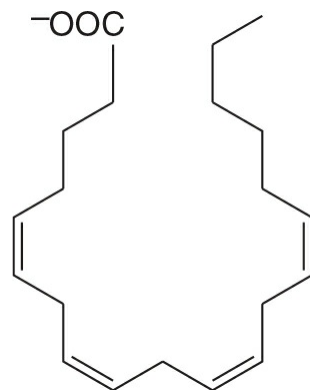

FIGURE 21–7 Arachidonic acid. Four double bonds in the *cis* configuration bend the molecule into a U shape.

Physical and Physiologic Properties of Fatty Acids Reflect Chain Length and Degree of Unsaturation

The melting points of even-numbered carbon fatty acids increase with chain length and decrease according to unsaturation. A triacylglycerol containing three saturated fatty acids of 12 or more carbons is solid at body temperature, whereas if the fatty acid residues are polyunsaturated, it is liquid to below 0°C. In practice, natural acylglycerols contain a mixture of fatty acids tailored to suit their functional roles. For example, membrane lipids, which must be fluid at all environmental temperatures, are more unsaturated than storage lipids. Lipids in tissues that are subject to cooling, for example, during hibernation or in the extremities of animals, are also more unsaturated.

ω3 Fatty Acids Are Anti-Inflammatory and Have Health Benefits

Long-chain ω3 fatty acids such as **α-linolenic (ALA)** (found in plant oils), **eicosapentaenoic (EPA)** (found in fish oil), and **docosahexaenoic (DHA)** (found in fish and algal oils) (Table 21–2) have anti-inflammatory effects, perhaps due to their promotion of the synthesis of less inflammatory prostaglandins and leukotrienes as compared to ω6 fatty acids (see Figure 23–12). In view of this, their potential use as a therapy in severe chronic disease where inflammation is a contributory cause is under intensive investigation. Current evidence suggests that diets rich in ω3 fatty acids are beneficial, particularly for **cardiovascular disease**, but also for other chronic degenerative diseases such as **cancer, rheumatoid arthritis, and Alzheimer disease**.

TRIACYLGLYCEROLS (TRIGLYCERIDES)* ARE THE MAIN STORAGE FORMS OF FATTY ACIDS

The triacylglycerols (Figure 21–8) are esters of the trihydric alcohol glycerol and fatty acids. Mono- and diacylglycerols, wherein one or two fatty acids are esterified with glycerol, are also found in the tissues. These are of particular significance in the synthesis and hydrolysis of triacylglycerols (see Chapters 24 and 25).

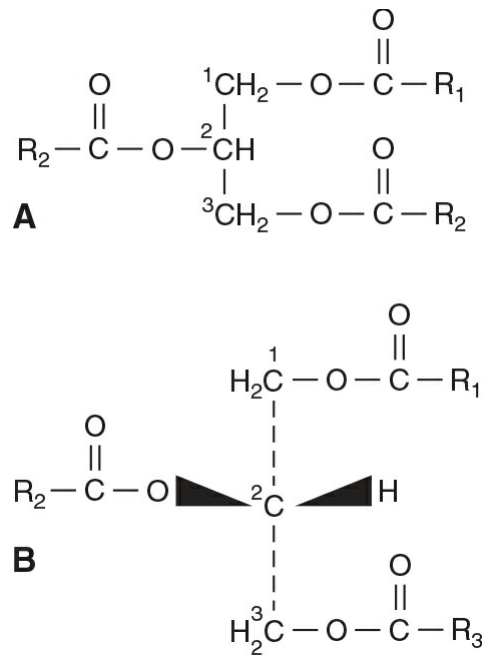

FIGURE 21–8 (A) Triacylglycerol. (B) Projection formula showing triacyl-*sn*-glycerol.

Carbons 1 & 3 of Glycerol Are Not Identical

To number the carbon atoms of glycerol unambiguously, the *-sn* (stereochemical numbering) system is used. It is important to realize that carbons 1 and 3 of glycerol are not identical when viewed in three dimensions (shown as a projection formula in [Figure 21–8B](#)). Enzymes readily distinguish between them and are nearly always specific for one or the other carbon; for example, glycerol is always phosphorylated on *sn*-3 by glycerol kinase to give glycerol-3-phosphate and not glycerol-1-phosphate (see [Figure 24–2](#)).

PHOSPHOLIPIDS ARE THE MAIN LIPID CONSTITUENTS OF MEMBRANES

Many phospholipids are derivatives of **phosphatidic acid** ([Figure 21–9](#)), in which the phosphate is esterified with one OH group of glycerol and the other two OH groups are esterified to two long-chain fatty acids (glycerophospholipids). Phosphatidic acid is important as an intermediate in the synthesis of triacylglycerols as well as phosphoglycerols (see [Figure 24–2](#)) but is not found in any great quantity in tissues. Sphingolipids, such as **sphingomyelin**, in which the phosphate is esterified to **sphingosine**, a complex amino alcohol ([Figure 21–10](#)), are also important membrane

components. Both glycerophospholipids and sphingolipids have two long-chain hydrocarbon tails which are important for their function in forming the lipid bilayer in cell membranes (see [Chapter 40](#)), but in the former both are fatty acid chains while in the latter one is a fatty acid and the second is part of the sphingosine molecule ([Figure 21–11](#)).

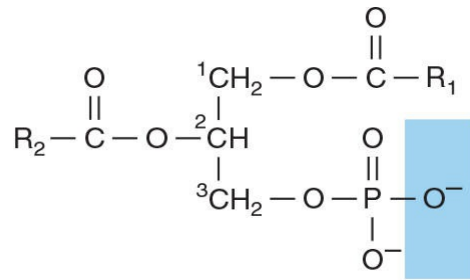

Phosphatidic acid

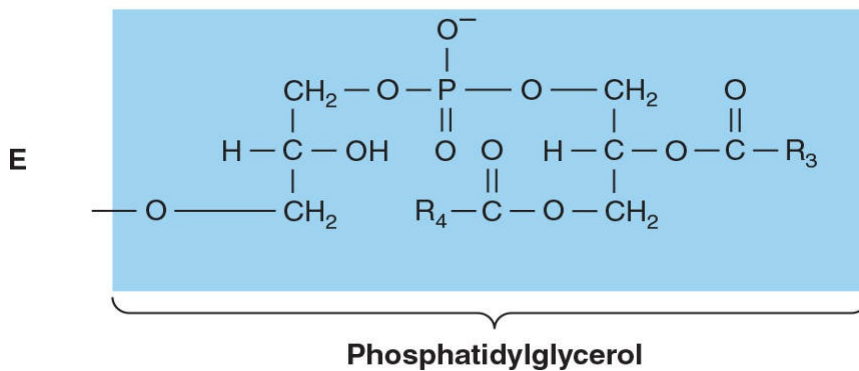
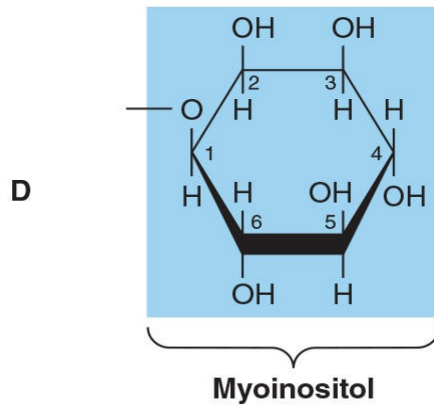
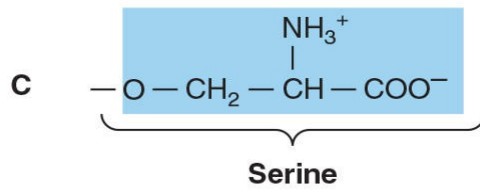
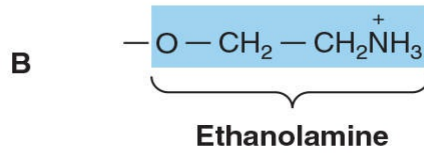
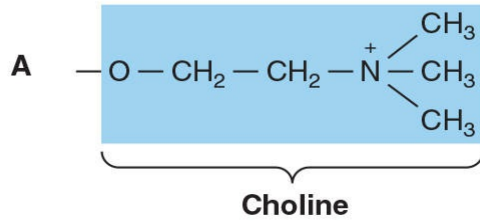

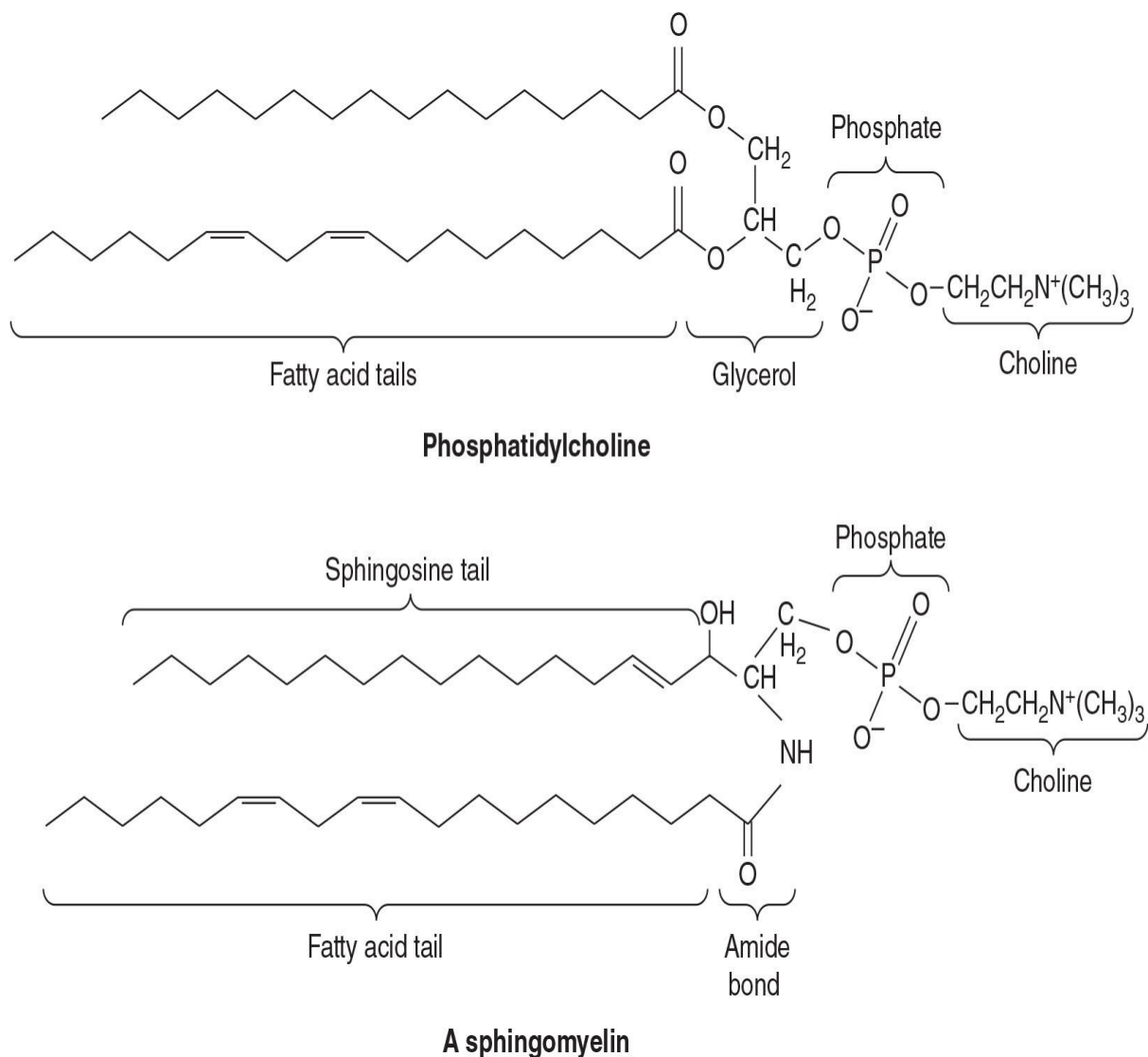

FIGURE 21–11 Comparison of glycerophospholipid and sphingolipid structures. Both types of phospholipid have two hydrocarbon tails, in glycerophospholipids both are fatty acid chains (a phosphatidylcholine with one saturated and one unsaturated fatty acid is shown) and in sphingolipids one is a fatty acid chain and the other is part of the sphingosine moiety (a sphingomyelin is shown). The two hydrophobic tails and the polar head group are important for the function of these phospholipids in the lipid bilayer in cell membranes (see [Chapter 40](#)).

Phosphatidylcholines (Lecithins) and Sphingomyelins Are Abundant in Cell Membranes

Glycerophospholipids containing **choline** ([Figure 21–9](#)), (phosphatidylcholines, commonly called **lecithins**) are the most abundant phospholipids of the cell membrane and represent a large proportion of the

body's store of choline. Choline is important in nervous transmission, as acetylcholine, and as a store of labile methyl groups. **Dipalmitoyl lecithin** is a very effective surface-active agent and a major constituent of the **surfactant** preventing adherence, due to surface tension, of the inner surfaces of the lungs. Its absence from the lungs of premature infants causes **respiratory distress syndrome**. Most phospholipids have a saturated acyl radical in the *sn*-1 position but an unsaturated radical in the *sn*-2 position of glycerol.

Phosphatidylethanolamine (cephalin) and **phosphatidylserine** (found in most tissues) are also found in cell membranes and differ from phosphatidylcholine only in that ethanolamine or serine, respectively, replaces choline (Figure 21–9). Phosphatidylserine also plays a role in **apoptosis** (programmed cell death).

Sphingomyelins are found in the outer leaflet of the cell membrane lipid bilayer and are particularly abundant in specialized areas of the plasma membrane known as **lipid rafts** (see Chapter 40). They are also found in large quantities in the **myelin sheath** that surrounds nerve fibers. They are believed to play a role in **cell signaling** and in **apoptosis**. Sphingomyelins contain no glycerol, and on hydrolysis they yield a fatty acid, phosphoric acid, choline, and sphingosine (Figure 21–10). The combination of sphingosine plus fatty acid is known as **ceramide**, a structure also found in the glycosphingolipids (see next section below).

Phosphatidylinositol Is a Precursor of Second Messengers

The inositol is present in **phosphatidylinositol** as the stereoisomer, myoinositol (Figure 21–9). Phosphorylated phosphatidylinositols (**phosphoinositides**) are minor components of cell membranes, but play an important part in **cell signaling and membrane trafficking**.

Phosphoinositides may have 1, 2, or 3 phosphate groups attached to the inositol ring. **Phosphatidylinositol 4,5-bisphosphate (PIP₂)**, for example, is cleaved into **diacylglycerol** and **inositol trisphosphate** upon stimulation by a suitable hormone agonist, and both of these act as internal signals or second messengers.

Cardiolipin Is a Major Lipid of Mitochondrial Membranes

Phosphatidic acid is a precursor of **phosphatidylglycerol**, which in turn

gives rise to **cardiolipin** (Figure 21–9). This phospholipid is found only in mitochondria and is essential for the mitochondrial function. Decreased cardiolipin levels or alterations in its structure or metabolism cause mitochondrial dysfunction in aging and in pathologic conditions including heart failure, hypothyroidism, and Barth syndrome (cardioskeletal myopathy).

Lysophospholipids Are Intermediates in the Metabolism of Phosphoglycerols

These are phosphoacylglycerols containing only one acyl radical, for example, **lysophosphatidylcholine (lysolecithin)** (Figure 21–12), which is important in the metabolism and interconversion of phospholipids. This compound is also found in oxidized lipoproteins and has been implicated in some of their effects in promoting **atherosclerosis**.

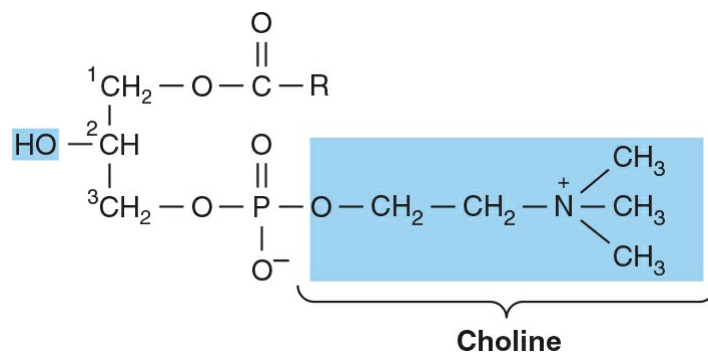

FIGURE 21–12 Lysophosphatidylcholine (lysolecithin).

Plasmalogens Occur in Brain & Muscle

These compounds constitute as much as 10 to 30% of the phospholipids of brain and heart. Structurally, the plasmalogens resemble phosphatidylethanolamine but possess an ether link on the *sn*-1 carbon instead of the ester link found in acylglycerols. Typically, the alkyl radical is an unsaturated alcohol (Figure 21–13). In some instances, choline, serine, or inositol may be substituted for ethanolamine. The function of plasmalogens remain poorly understood, but it has been suggested that they may have a protective effect against reactive oxygen species.

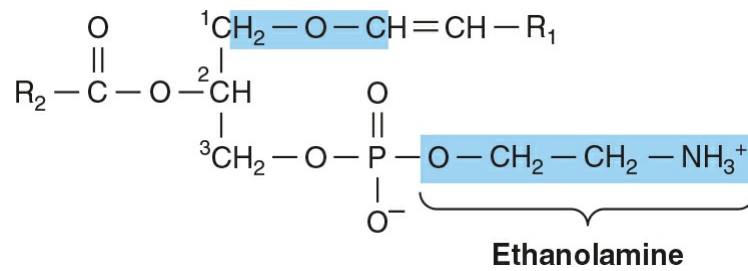

FIGURE 21–13 Plasmalogen.

GLYCOLIPIDS (GLYCOSPHINGOLIPIDS) ARE IMPORTANT IN NERVE TISSUES & IN THE CELL MEMBRANE

Glycolipids are lipids with an attached carbohydrate or carbohydrate chain. They are widely distributed in every tissue of the body, particularly in nervous tissue such as brain. They occur particularly in the outer leaflet of the plasma membrane, where they contribute to **cell surface carbohydrates** which form the **glycocalyx** (see [Chapter 15](#)).

The major glycolipids found in animal tissues are glycosphingolipids. They contain ceramide and one or more sugars. **Galactosylceramide** ([Figure 21–14](#)) is a major glycosphingolipid of brain and other nervous tissue, found in relatively low amounts elsewhere. It contains a number of characteristic C24 fatty acids, for example, cerebronic acid.

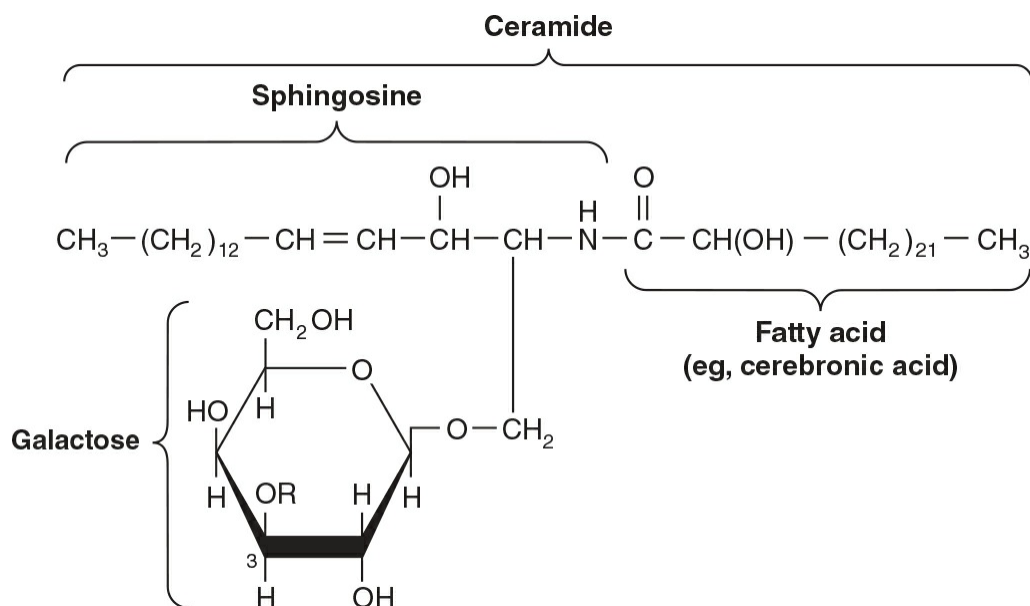

FIGURE 21–14 Structure of galactosylceramide.

Galactosylceramide can be converted to sulfogalactosylceramide

(**sulfatide**) which has a sulfo group attached to the O in the three position of galactose and is present in high amounts in **myelin**. **Glucosylceramide** resembles galactosylceramide, but the head group is glucose rather than galactose. It is the predominant simple glycosphingolipid of extraneural tissues, also occurring in the brain in small amounts. **Gangliosides** are complex glycosphingolipids derived from glucosylceramide that contain in addition one or more molecules of a **sialic acid**. **Neuraminic acid** (NeuAc, see [Chapter 15](#)) is the principal sialic acid found in human tissues. Gangliosides are also present in nervous tissues in high concentration. They function in cell–cell recognition and communication and as receptors for hormones and bacterial toxins such as cholera toxin. The simplest ganglioside found in tissues is **GM₃**, which contains ceramide, one molecule of glucose, one molecule of galactose, and one molecule of NeuAc. In the shorthand nomenclature used, G represents ganglioside; M is a monosialo-containing species; and the subscript 3 is a number assigned on the basis of chromatographic migration. **GM1** ([Figure 21–15](#)), a more complex ganglioside derived from GM₃, is of considerable biologic interest, as it is known to be the receptor in human intestine for **cholera toxin**. Other gangliosides can contain anywhere from one to five molecules of sialic acid, giving rise to di-, trisialogangliosides, etc.

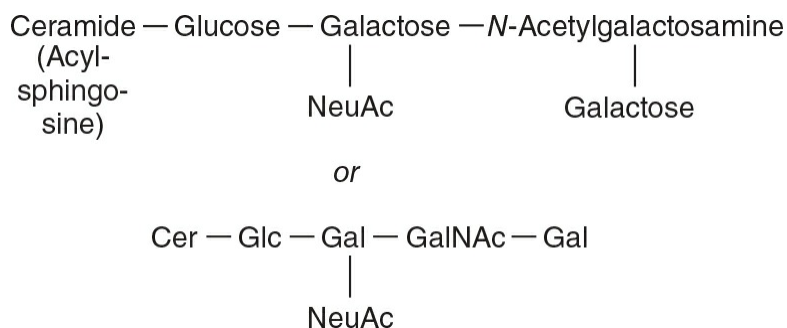

FIGURE 21–15 GM1 ganglioside, a monosialoganglioside, the receptor in human intestine for cholera toxin.

STERIODS PLAY MANY PHYSIOLOGICALLY IMPORTANT ROLES

Although **cholesterol** is probably best known by most people for its association with **atherosclerosis** and heart disease, it has many essential roles in the body. It is the precursor of a large number of equally important **steroids** that include the **bile acids**, **adrenocortical hormones**, **sex hormones**, **vitamin D** (see [Chapters 26, 41, 44](#)), and **cardiac glycosides**.

All steroids have a similar cyclic nucleus resembling phenanthrene (rings A, B, and C) to which a cyclopentane ring (D) is attached. The carbon positions on the steroid nucleus are numbered as shown in **Figure 21–16**. It is important to realize that in structural formulas of steroids, a simple hexagonal ring denotes a completely saturated six-carbon ring with all valences satisfied by hydrogen bonds unless shown otherwise; that is, it is not a benzene ring. All double bonds are shown as such. Methyl side chains are shown as single bonds unattached at the farther (methyl) end. These occur typically at positions 10 and 13 (constituting C atoms 19 and 18). A side chain at position 17 is usual (as in cholesterol). If the compound has one or more hydroxyl groups and no carbonyl or carboxyl groups, it is a **sterol**, and the name terminates in *-ol*.

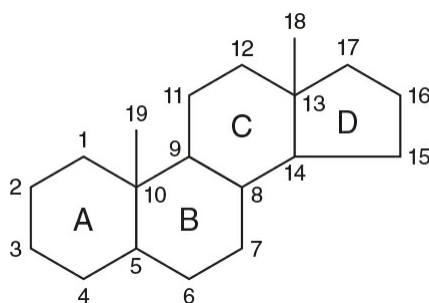

FIGURE 21–16 The steroid nucleus.

Because of Asymmetry in the Steroid Molecule, Many Stereoisomers Are Possible

Each of the six-carbon rings of the steroid nucleus is capable of existing in the three-dimensional conformation either of a “chair” or a “boat” (**Figure 21–17**). In naturally occurring steroids, virtually all the rings are in the “chair” form, which is the more stable conformation. With respect to each other, the rings can be either *cis* or *trans* (**Figure 21–18**). The junction between the A and B rings may be *cis* or *trans* in naturally occurring steroids. The junction between B and C is *trans*, as is usually the C/D junction. Bonds attaching substituent groups above the plane of the rings (β bonds) are shown with bold solid lines, whereas those bonds attaching groups below (α bonds) are indicated with broken lines. The A ring of a 5α steroid (ie, the hydrogen at position 5 is in the α configuration) is always *trans* to the B ring, whereas it is *cis* in a 5β steroid (ie, the hydrogen at position 5 is in the β configuration). The methyl groups attached to C10 and C13 are invariably in the β configuration.

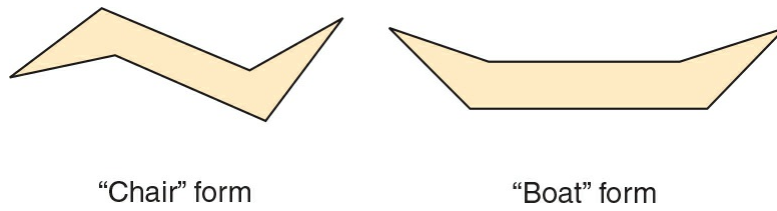

FIGURE 21–17 Conformations of stereoisomers of the steroid nucleus.

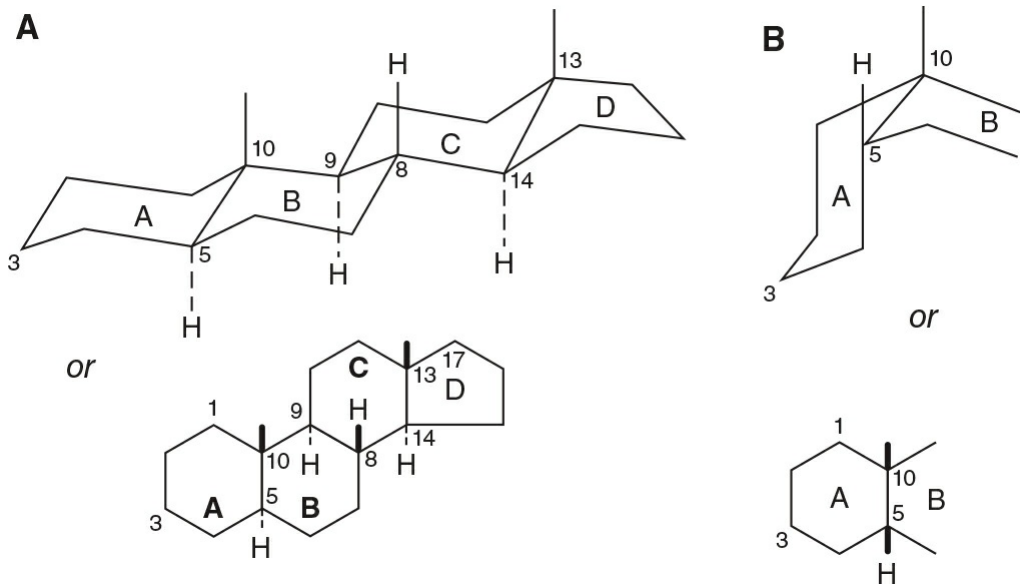

FIGURE 21–18 Generalized steroid nucleus, showing (A) an all-*trans* configuration between adjacent rings and (B) a *cis* configuration between rings A and B.

Cholesterol Is a Significant Constituent of Many Tissues

Cholesterol (**Figure 21–19**) is widely distributed in all cells of the body but particularly in nervous tissue. It is a major constituent of the plasma membrane (see **Chapter 40**) and of plasma lipoproteins (see **Chapter 26**). It is often found as **cholesteryl ester**, where the hydroxyl group on position 3 is esterified with a long-chain fatty acid. It occurs in animals but not in plants or bacteria.

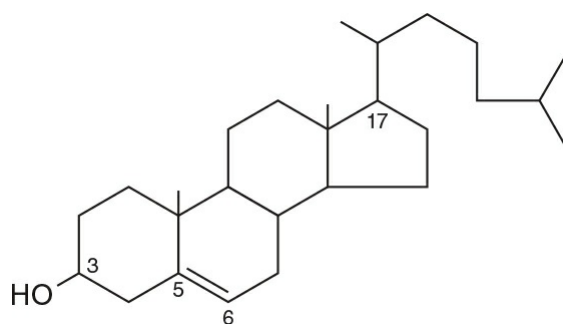

FIGURE 21–19 Cholesterol.

Ergosterol Is a Precursor of Vitamin D

Ergosterol occurs in plants and yeast and is important as a dietary source of vitamin D (**Figure 21–20**). When irradiated with ultraviolet light in the skin, ring B is opened to form vitamin D₂ in a process similar to the one that forms vitamin D₃ from 7-dehydrocholesterol in the skin (see **Figure 44–3**).

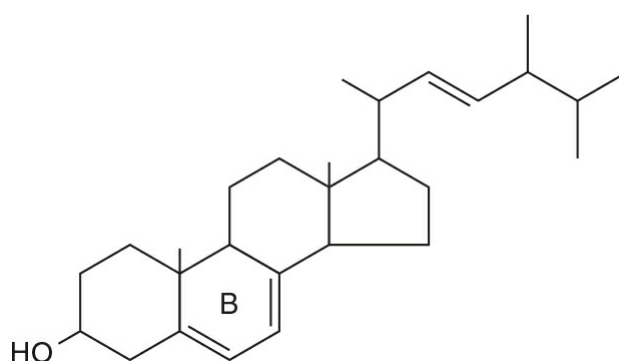

FIGURE 21–20 Ergosterol.

Polyprenoids Share the Same Parent Compound as Cholesterol

Polyprenoids are not steroids but are related to them because they are synthesized, like cholesterol (see **Figure 26–2**), from five-carbon isoprene units (**Figure 21–21**). They include **ubiquinone** (see **Chapter 13**), which participates in the respiratory chain in mitochondria, and the long-chain alcohol **dolichol** (**Figure 21–22**), which takes part in glycoprotein synthesis by transferring carbohydrate residues to asparagine residues of the polypeptide (see **Chapter 46**). Plant-derived polyprenoids include rubber, camphor, the fat-soluble vitamins A, D, E, and K, and β -carotene (provitamin A).

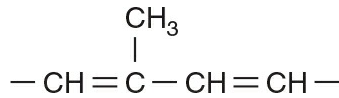

FIGURE 21–21 Isoprene unit.

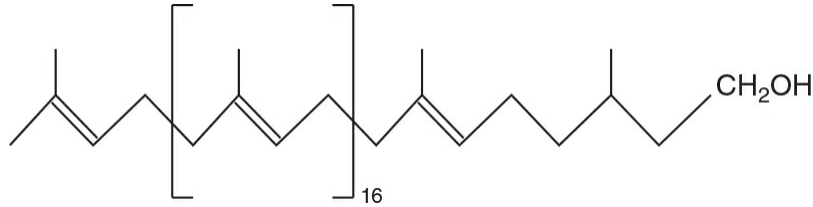

FIGURE 21–22 Dolichol—a C95 alcohol.

LIPID PEROXIDATION IS A SOURCE OF FREE RADICALS

Peroxidation (**auto-oxidation**) of lipids exposed to oxygen is responsible not only for deterioration of foods (**rancidity**), but also for damage to tissues in vivo, where it may be a cause of cancer, inflammatory diseases, atherosclerosis, and aging. The deleterious effects are considered to be caused by **free radicals**, molecules that have unpaired valence electrons, making them highly reactive. Free radicals containing oxygen (eg, ROO^\bullet , RO^\bullet , OH^\bullet) are termed **reactive oxygen species (ROS)**. These are produced during peroxide formation from fatty acids containing methylene-interrupted double bonds, that is, those found in the naturally occurring polyunsaturated fatty acids (**Figure 21–23**). **Lipid peroxidation** is a chain reaction in which free radicals formed in the initiation stage in turn generate more (propagation), and thus it has potentially devastating effects. The processes of initiation and propagation can be depicted as follows:

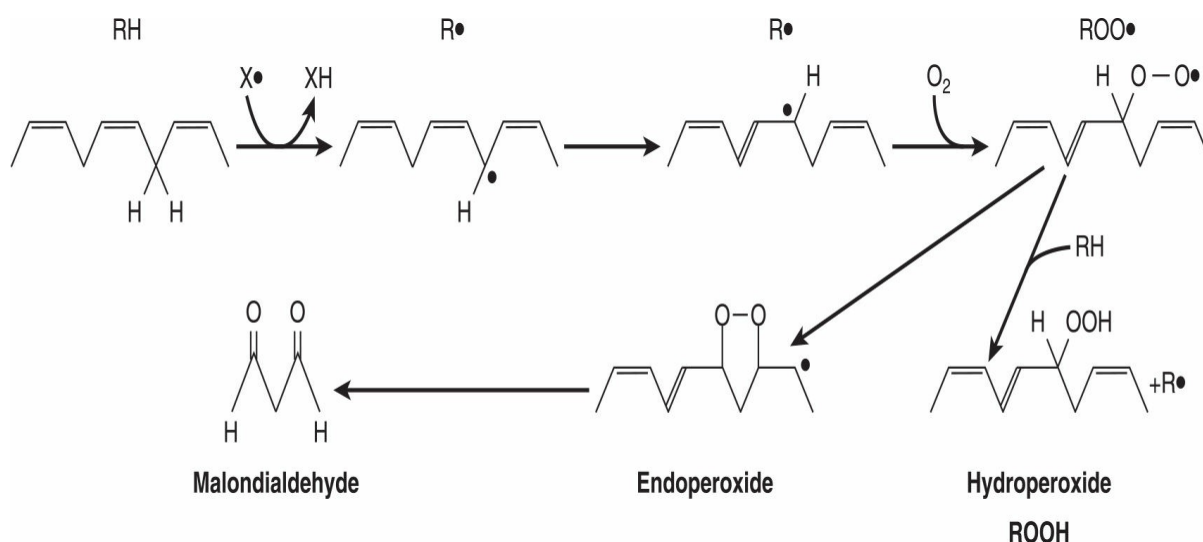
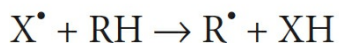
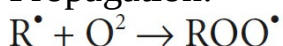

FIGURE 21–23 Lipid peroxidation. The reaction is initiated by an existing free radical (X^\bullet), by light, or by metal ions. Malondialdehyde is only formed by fatty acids with three or more double bonds and is used as a measure of lipid peroxidation together with ethane from the terminal two carbons of $\omega 3$ fatty acids and pentane from the terminal five carbons of $\omega 6$ fatty acids.

1. Initiation:



2. Propagation:



3. Termination:

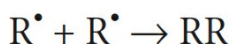
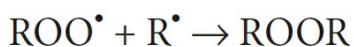
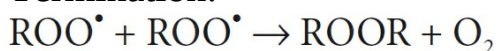

Antioxidants are used to control and reduce lipid peroxidation, both by humans in their activities and in nature. Propyl gallate, butylated hydroxyanisole (BHA), and butylated hydroxytoluene (BHT) are antioxidants used as food additives. Naturally occurring antioxidants include vitamin E (tocopherol) (see [Chapter 44](#)), which is lipid soluble, and urate and vitamin C, which are water soluble. β -Carotene is an antioxidant at low PO_2 . Antioxidants fall into two classes: (1) **preventive antioxidants**, which reduce the rate of chain initiation (stage 1 above) and

(2) **chain-breaking antioxidants**, which interfere with chain propagation (stage 2 above). Preventive antioxidants include catalase and other peroxidases such as glutathione peroxidase (see [Figure 20–3](#)) that react with ROOH; selenium, which is an essential component of glutathione peroxidase and regulates its activity, and chelators of metal ions such as ethylenediaminetetraacetate (EDTA) and diethylenetriaminepentaacetate (DTPA). In vivo, the principal chain-breaking antioxidants are superoxide dismutase, which acts in the aqueous phase to trap superoxide free radicals ($O_2^{\cdot-}$) urate, and vitamin E, which acts in the lipid phase to trap ROO^{\cdot} radicals.

Peroxidation is also catalyzed in vivo by heme compounds and by **lipoygenases** (see [Figure 23–13](#)) found in platelets and leukocytes. Other products of auto-oxidation or enzymic oxidation of physiologic significance include **oxysterols** (formed from cholesterol) and the prostaglandin-like **isoprostanes** (formed from the peroxidation of polyunsaturated fatty acids such as arachidonic acid) which are used as reliable markers of oxidative stress in humans.

AMPHIPATHIC LIPIDS SELF-ORIENT AT OIL: WATER INTERFACES

They Form Membranes, Micelles, Liposomes, & Emulsions

In general, lipids are insoluble in water since they contain a predominance of nonpolar (hydrocarbon) groups. However, fatty acids, phospholipids, sphingolipids, bile salts, and, to a lesser extent, cholesterol contain polar groups. Therefore, a part of the molecule is **hydrophobic**, or water insoluble, and a part is **hydrophilic**, or water soluble. Such molecules are described as **amphipathic** ([Figure 21–24](#)). They become oriented at oil-water interfaces with the polar group in the water phase and the nonpolar group in the oil phase. A bilayer of such amphipathic lipids is the basic structure in biologic **membranes** (see [Chapter 40](#)). When a critical concentration of these lipids is present in an aqueous medium, they form **micelles**. **Liposomes** may be formed by sonicating an amphipathic lipid in an aqueous medium. They consist of spheres of lipid bilayers that enclose part of the aqueous medium. Aggregation of bile salts into micelles and liposomes and the formation of **mixed micelles** with the products of fat digestion are important in facilitating absorption of lipids from the intestine. Liposomes are of potential clinical use—particularly when

combined with tissue-specific antibodies—as carriers of drugs in the circulation, targeted to specific organs, for example, in cancer therapy. In addition, they are used for gene transfer into vascular cells and as carriers for topical and transdermal delivery of drugs and cosmetics. **Emulsions** are much larger particles, formed usually by nonpolar lipids in an aqueous medium. These are stabilized by emulsifying agents such as amphipathic lipids (eg, phosphatidylcholine), which form a surface layer separating the main bulk of the nonpolar material from the aqueous phase (Figure 21–24).

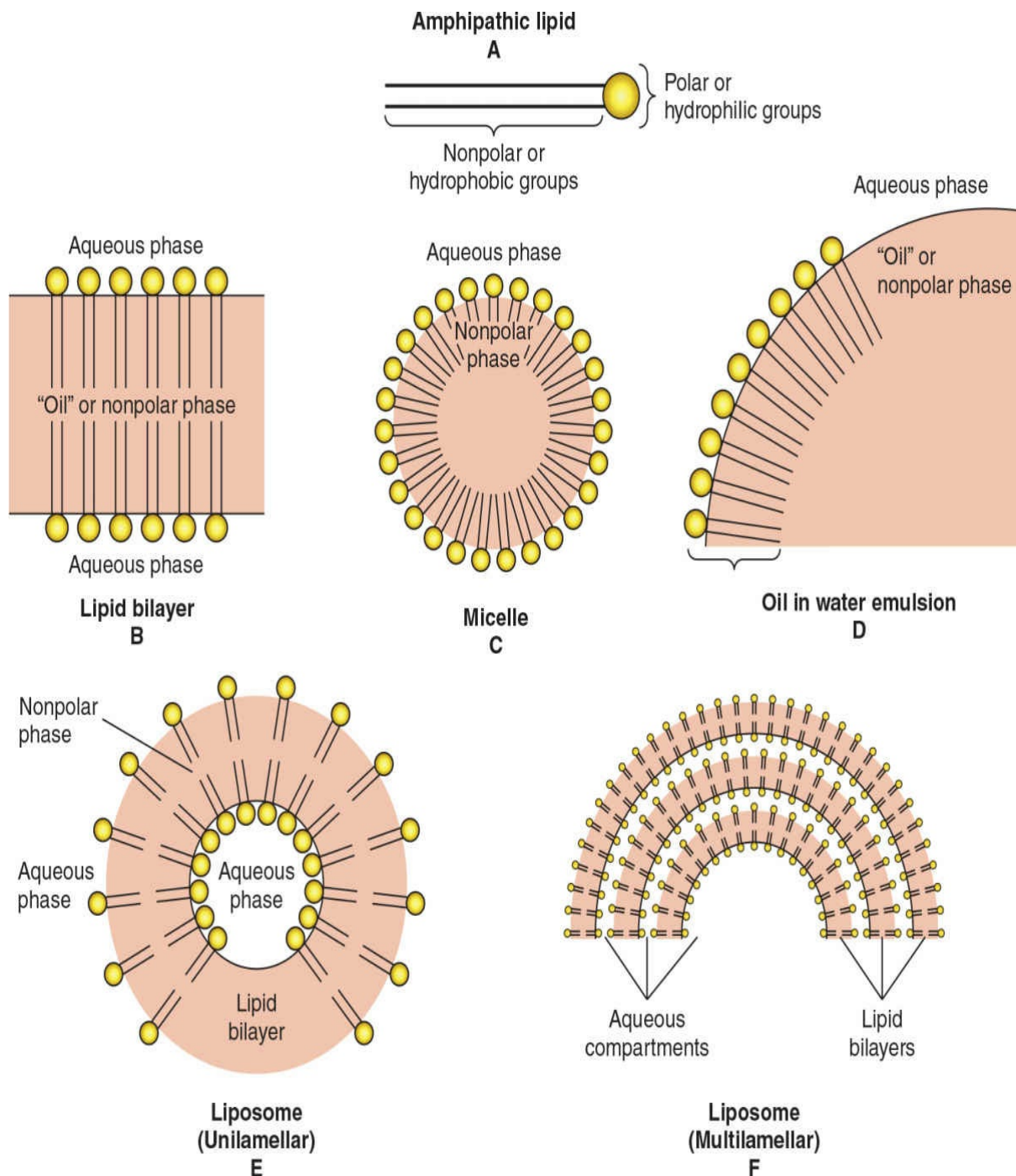

FIGURE 21–24 Formation of lipid membranes, micelles, emulsions, and liposomes from amphipathic lipids, for example, phospholipids.

SUMMARY

- Lipids have the common property of being relatively insoluble in water (hydrophobic) but soluble in nonpolar solvents. Amphipathic lipids also contain one or more polar groups, making them suitable as constituents of membranes at lipid-water interfaces.
- Lipids of major physiologic significance include fatty acids and their esters, together with cholesterol and other steroids.
- Long-chain fatty acids may be saturated, monounsaturated, or polyunsaturated, according to the number of double bonds present. Their fluidity decreases with chain length and increases according to degree of unsaturation.
- Eicosanoids are formed from 20-carbon polyunsaturated fatty acids and make up an important group of physiologically and pharmacologically active compounds known as prostaglandins, thromboxanes, leukotrienes, and lipoxins.
- The esters of glycerol are quantitatively the most significant lipids, represented by triacylglycerol (“fat”), a major constituent of some lipoprotein classes and the storage form of lipid in adipose tissue. Glycerophospholipids and sphingolipids are amphipathic lipids and have important roles—as major constituents of membranes and the outer layer of lipoproteins, as surfactant in the lung, as precursors of second messengers, and as constituents of nervous tissue.
- Glycolipids are also important constituents of nervous tissue such as brain and the outer leaflet of the cell membrane, where they contribute to the carbohydrates on the cell surface.
- Cholesterol, an amphipathic lipid, is an important component of membranes. It is the parent molecule from which all other steroids in the body, including major hormones such as the adrenocortical and sex hormones, D vitamins, and bile acids, are synthesized.
- Peroxidation of lipids containing polyunsaturated fatty acids leads to generation of free radicals that damage tissues and cause disease.

REFERENCES

Eljamil AS: *Lipid Biochemistry: For Medical Sciences*. iUniverse, 2015.
Gurr MI, Harwood JL, Frayn KN, et al: *Lipids, Biochemistry*,

*According to the standardized terminology of the International Union of Pure and Applied Chemistry and the International Union of Biochemistry, the monoglycerides, diglycerides, and triglycerides should be designated monoacylglycerols, diacylglycerols, and triacylglycerols, respectively. However, the older terminology is still widely used, particularly in clinical medicine.

Oxidation of Fatty Acids: Ketogenesis

Kathleen M. Botham, PhD, DSc & Peter A. Mayes, PhD, DSc

OBJECTIVES

After studying this chapter, you should be able to:

- Describe the processes by which fatty acids are transported in the blood, activated and transported into the matrix of the mitochondria for breakdown to obtain energy.
- Outline the β -oxidation pathway by which fatty acids are metabolized to acetyl-CoA and explain how this leads to the production of large quantities of ATP.
- Identify the three compounds termed “ketone bodies” and describe the reactions by which they are formed in liver mitochondria.
- Recognize that ketone bodies are important fuels for extrahepatic tissues and indicate the conditions in which their synthesis and use are favored.
- Indicate the three stages in the metabolism of fatty acids where ketogenesis is regulated.
- Indicate that overproduction of ketone bodies leads to ketosis and, if prolonged, ketoacidosis, and identify pathologic conditions

when this occurs.

- Give examples of diseases associated with impaired fatty acid oxidation.

BIOMEDICAL IMPORTANCE

Fatty acids are broken down in mitochondria by oxidation to acetyl-CoA in a process that generates large amounts of energy. When this pathway is proceeding at a high rate, three compounds, **acetoacetate**, **D-3-hydroxybutyrate**, and **acetone**, known collectively as the **ketone bodies**, are produced by the liver. Acetoacetate and D-3-hydroxybutyrate are used as fuels by extrahepatic tissues in normal metabolism, but overproduction of ketone bodies causes **ketosis**. Increased fatty acid oxidation and consequently ketosis is a characteristic of starvation and of diabetes mellitus. Since ketone bodies are acidic, when they are produced in excess over long periods, as in diabetes, they cause **ketoacidosis**, which is ultimately fatal. Because gluconeogenesis is dependent on fatty acid oxidation, any impairment in fatty acid oxidation leads to **hypoglycemia**. This occurs in various states of **carnitine deficiency** or deficiency of essential enzymes in fatty acid oxidation, for example, **carnitine palmitoyltransferase**, or inhibition of fatty acid oxidation by poisons, for example, **hypoglycin**.

OXIDATION OF FATTY ACIDS OCCURS IN MITOCHONDRIA

Although acetyl-CoA is both an end point of fatty acid catabolism and the starting substrate for fatty acid synthesis, breakdown is not simply the reverse of the biosynthetic pathway, but an entirely separate process taking place in a different compartment of the cell. The separation of fatty acid oxidation in mitochondria from biosynthesis in the cytosol allows each process to be individually controlled and integrated with tissue requirements. Each step in fatty acid oxidation involves acyl-CoA derivatives, is catalyzed by separate enzymes, utilizes NAD^+ and FAD as coenzymes, and generates ATP. It is an aerobic process, requiring the presence of oxygen.

Fatty Acids Are Transported in the Blood as Free

Fatty Acids

Free fatty acids (FFAs)—also called unesterified (UFA) or nonesterified (NEFA) fatty acids (see [Chapter 21](#))—are fatty acids that are in the **unesterified state**. In plasma, longer-chain FFA are combined with **albumin**, and in the cell they are attached to a **fatty acid-binding protein**, so that in fact they are never really “free.” Shorter-chain fatty acids are more water soluble and exist as the unionized acid or as a fatty acid anion.

Fatty Acids Are Activated Before Being Catabolized

Fatty acids must first be converted to an active intermediate before they can be catabolized. This is the only step in the complete degradation of a fatty acid that requires energy from ATP. In the presence of ATP and coenzyme A, the enzyme **acyl-CoA synthetase (thiokinase)** catalyzes the conversion of a fatty acid (or FFA) to an “active fatty acid” or **acyl-CoA**, using one high-energy phosphate and forming AMP and PP_i ([Figure 22–1](#)). The PP_i is hydrolyzed by **inorganic pyrophosphatase** with the loss of a further high-energy phosphate, ensuring that the overall reaction goes to completion. Acyl-CoA synthetases are found in the endoplasmic reticulum, peroxisomes, and on the outer membrane of mitochondria.

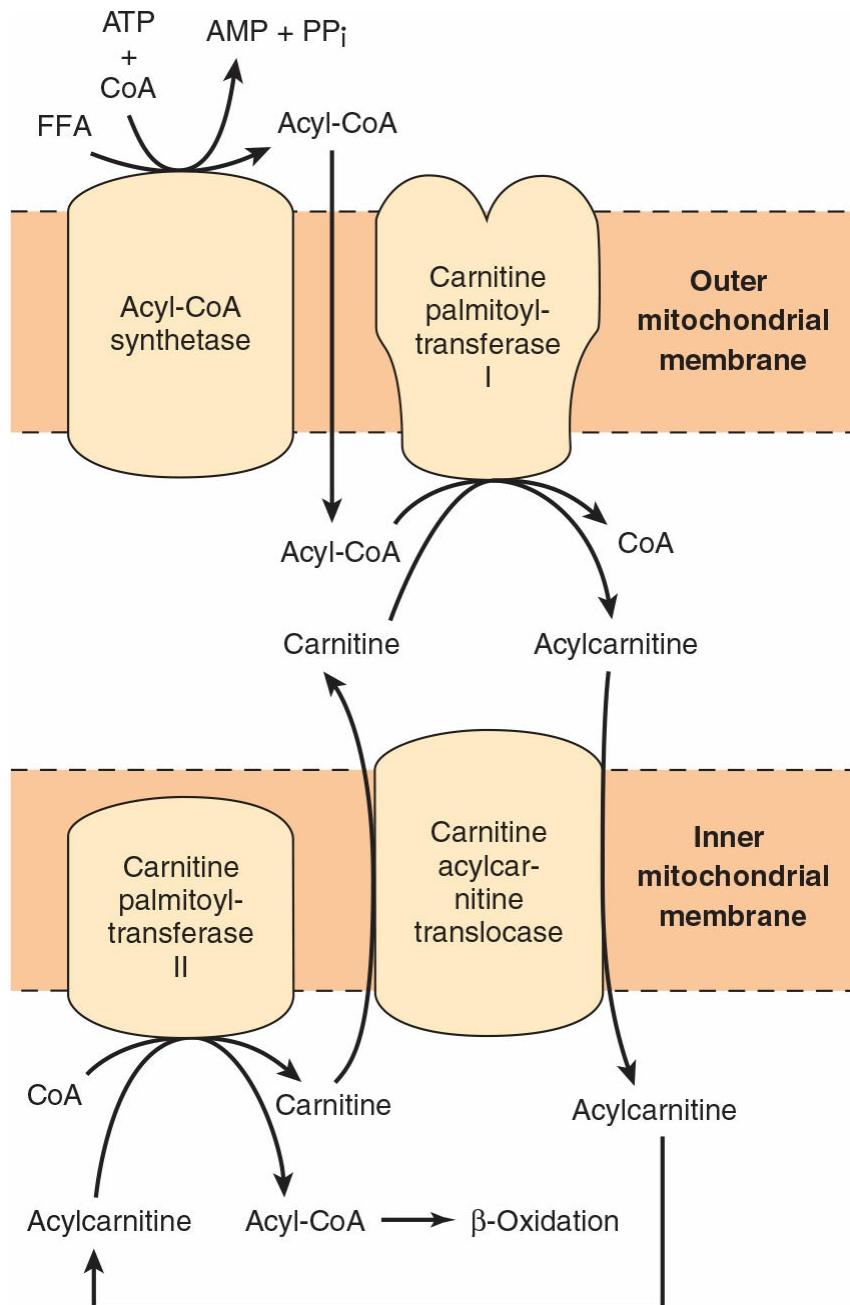

FIGURE 22–1 Role of carnitine in the transport of long-chain fatty acids through the inner mitochondrial membrane. Long-chain acyl-CoA formed by acyl-CoA synthetase enters the intermembrane space. For transport across the inner membrane, acyl groups must be transferred from CoA to carnitine by carnitine palmitoyltransferase-I. The acylcarnitine formed is then carried into the matrix by a translocase enzyme in exchange for a free carnitine and acyl-CoA is reformed by carnitine palmitoyltransferase-II.

Long-Chain Fatty Acids Cross the Inner

Mitochondrial Membrane as Carnitine Derivatives

Carnitine (β -hydroxy- γ -trimethylammonium butyrate), $(\text{CH}_3)_3 \text{N}^+ \text{—CH}_2 \text{—CH(OH)—CH}_2 \text{—COO}^-$, is widely distributed and is particularly abundant in muscle. Long-chain acyl-CoA (or FFA) cannot penetrate the inner membrane of mitochondria. In the presence of carnitine, however, **carnitine palmitoyltransferase-I**, located in the outer mitochondrial membrane, transfers the long-chain acyl group from CoA to carnitine, forming **acylcarnitine** and releasing CoA. Acylcarnitine is able to penetrate the inner membrane and gain access to the β -oxidation system of enzymes via the inner membrane exchange transporter **carnitine-acylcarnitine translocase**. The transporter binds acylcarnitine and transports it across the membrane in exchange for carnitine. The acyl group is then transferred to CoA so that acyl-CoA is reformed and carnitine is liberated. This reaction is catalyzed by **carnitine palmitoyltransferase-II**, which is located on the inside of the inner membrane ([Figure 22–1](#)).

β -OXIDATION OF FATTY ACIDS INVOLVES SUCCESSIVE CLEAVAGE WITH RELEASE OF ACETYL-COA

In the [Figure 22–2](#), pathway for the oxidation of fatty acids, two carbons at a time are cleaved from acyl-CoA molecules, starting at the carboxyl end. The chain is broken between the $\alpha(2)$ - and $\beta(3)$ -carbon atoms—hence the process is termed **β -oxidation**. The two-carbon units formed are acetyl-CoA; thus, palmitoyl(C16)-CoA forms eight acetyl-CoA molecules.

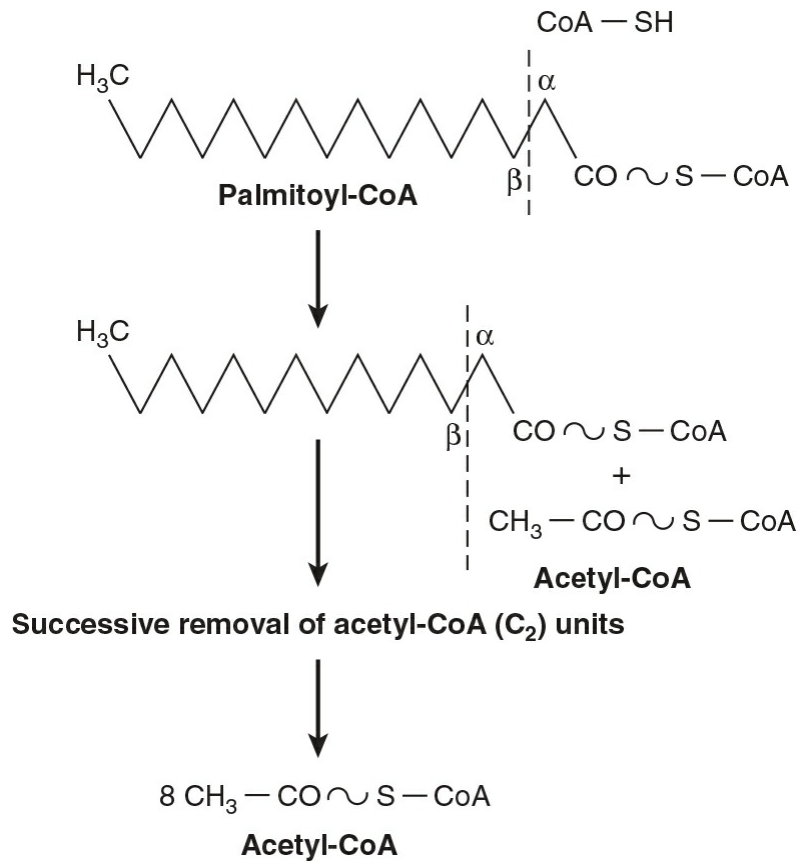

FIGURE 22–2 Overview of β -oxidation of fatty acids.

The β -Oxidation Cycle Generates $FADH_2$ & $NADH$

Several enzymes, known collectively as “fatty acid oxidase,” are found in the mitochondrial matrix or inner membrane adjacent to the respiratory chain. These catalyze the oxidation of acyl-CoA to acetyl-CoA via the β -oxidation pathway. The system proceeds in cyclic fashion which results in the degradation of long fatty acids to acetyl-CoA. In the process, large quantities of the reducing equivalents $FADH_2$ and $NADH$ are generated and are used to form ATP by oxidative phosphorylation (see [Chapter 13](#)) ([Figure 22–3](#)).

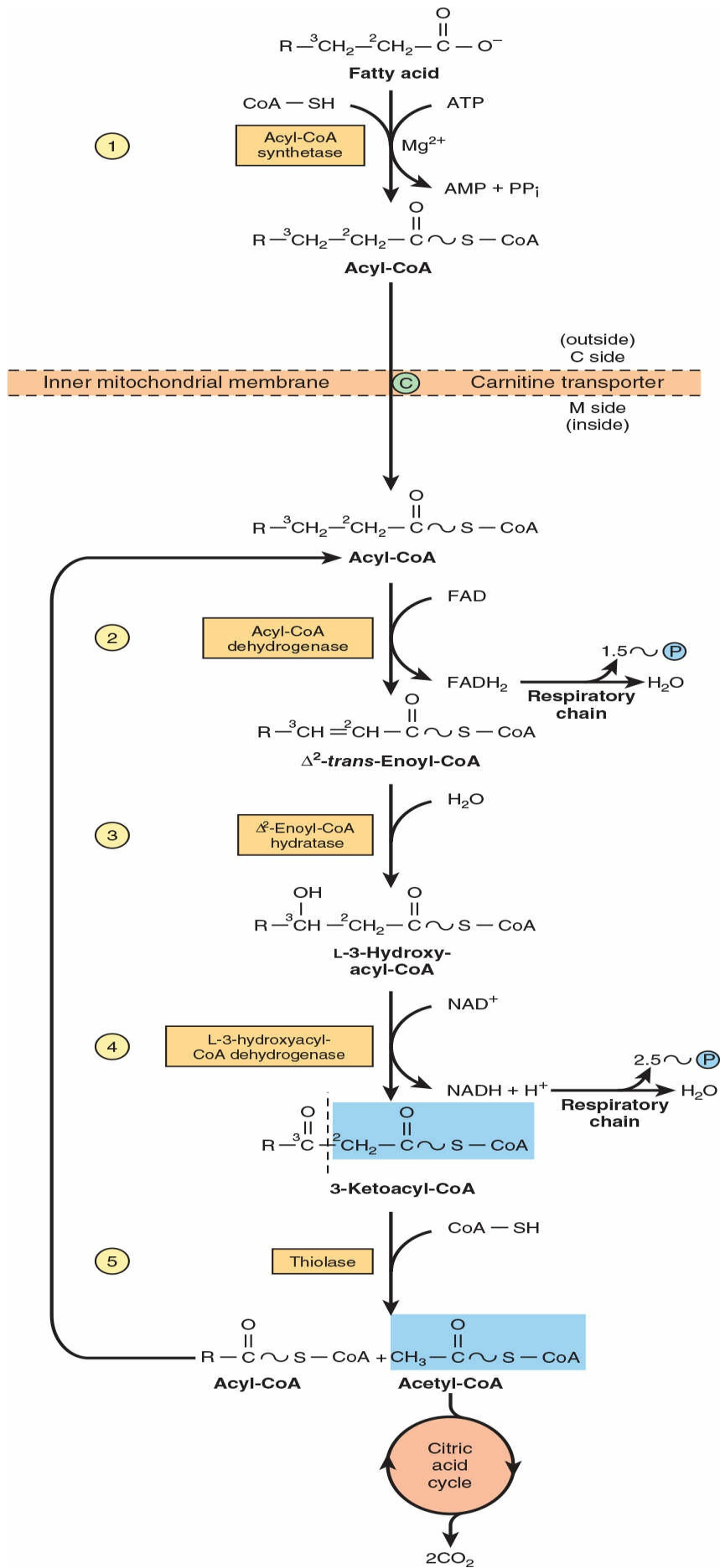

FIGURE 22–3 β -Oxidation of fatty acids. Long-chain acyl-CoA is cycled through reactions Symbol ② to Symbol ⑤, acetyl-CoA being split off, each cycle, by thiolase (reaction Symbol ⑤). When the acyl radical is only four carbon atoms in length, two acetyl-CoA molecules are formed in reaction Symbol ⑤.

The first step is the removal of two hydrogen atoms from the 2(α)- and 3(β)-carbon atoms, catalyzed by **acyl-CoA dehydrogenase** and requiring flavin adenine dinucleotide (FAD). This results in the formation of Δ^2 -*trans*-enoyl-CoA and FADH₂. Water is added to saturate the double bond and form 3-hydroxyacyl-CoA, catalyzed by Δ^2 -**enoyl-CoA hydratase**. The 3-hydroxy derivative undergoes further dehydrogenation on the 3-carbon catalyzed by **L-3-hydroxyacyl-CoA dehydrogenase** to form the corresponding 3-ketoacyl-CoA compound. In this case, NAD⁺ is the coenzyme involved. Finally, 3-ketoacyl-CoA is split at the 2,3-position by **thiolase** (3-ketoacyl-CoA-thiolase), forming acetyl-CoA and a new acyl-CoA two carbons shorter than the original acyl-CoA molecule. The shorter acyl-CoA formed in the cleavage reaction reenters the oxidative pathway at reaction 2 (Figure 22–3). In this way, a long-chain fatty acid with an even number of carbons may be degraded completely to acetyl-CoA (C₂ units). For example, after seven cycles, the C16 fatty acid, palmitate, would be converted to eight acetyl-CoA molecules. Since acetyl-CoA can be oxidized to CO₂ and water via the citric acid cycle (which is also found within the mitochondria), the complete oxidation of fatty acids is achieved.

Fatty acids with an odd number of carbon atoms are oxidized by the pathway of β -oxidation described above producing acetyl-CoA until a three-carbon (propionyl-CoA) residue remains. This compound is converted to succinyl-CoA, a constituent of the citric acid cycle (see Figure 16–2). Hence, **the propionyl residue from an odd-chain fatty acid is the only part of a fatty acid that is glucogenic.**

Oxidation of Fatty Acids Produces a Large Quantity of ATP

Each cycle of β -oxidation generates one molecule of FADH₂ and one of NADH. The breakdown of 1 mol of the C16 fatty acid, palmitate, requires seven cycles and produces 8 mol of acetyl-CoA. Oxidation of the reducing equivalents via the respiratory chain leads to the synthesis of 28 mol of

ATP (**Table 22–1** and see **Chapter 13**) and oxidation of acetyl-CoA via the citric acid cycle produces 80 mol of ATP (**Table 22–1** and see **Chapter 16**). The breakdown of 1 mol of palmitate, therefore, yields a gross total of 108 mol of ATP. However, two high-energy phosphates are used in the initial activation step (**Figure 22–3**), thus there is a net gain of 106 mol of ATP per mole of palmitate used (**Table 22–1**), or $106 \times 30.5^* = 3233$ kJ. This represents 33% of the free energy of combustion of palmitic acid.

TABLE 22–1 Generation of ATP from the Complete Oxidation of a C16 Fatty Acid

Step	Product	Amount Product Formed (mol)/mol Palmitate	ATP Formed (mol)/mol Product	Total ATP Formed (mol)/mol Palmitate	ATP Used (mol)/mol Palmitate
Activation		-			2
β-Oxidation	FADH ₂	7	1.5	10.5	-
β-Oxidation	NADH	7	2.5	17.5	-
Citric acid cycle	Acetyl-CoA	8	10	80	-
Total ATP formed (mol)/mol palmitate				108	
Total ATP used (mol)/mol palmitate					2

The table shows how the oxidation of 1 mol of the C16 fatty acid, palmitate, generates 106 mol of ATP (108 formed in total—2 used in the activation step).

Peroxisomes Oxidize Very-Long-Chain Fatty Acids

A modified form of β-oxidation is found in **peroxisomes** and leads to the breakdown of very-long-chain fatty acids (eg, C20, C22) with the formation of acetyl-CoA and H₂O₂, which is broken down by catalase (see **Chapter 12**). This system is not linked directly to phosphorylation and the generation of ATP, and also does not attack shorter-chain fatty acids; the β-oxidation sequence ends at octanoyl-CoA. Octanoyl and acetyl groups are both further oxidized in mitochondria. The peroxisomal enzymes are induced by high-fat diets and in some species by hypolipidemic drugs such as clofibrate.

Another role of peroxisomal β-oxidation is to shorten the side chain of cholesterol in bile acid formation (see **Chapter 26**). Peroxisomes also take part in the synthesis of ether glycerolipids (see **Chapter 24**), cholesterol, and dolichol (see **Figure 26–2**).

Oxidation of Unsaturated Fatty Acids Occurs by a Modified β -Oxidation Pathway

The CoA esters of unsaturated fatty acids are degraded by the enzymes normally responsible for β -oxidation until either a Δ^3 -*cis*-acyl-CoA compound or a Δ^4 -*cis*-acyl-CoA compound is formed, depending on the position of the double bonds (**Figure 22–4**). The former compound is isomerized (Δ^3 *cis* \rightarrow Δ^2 -*trans*-enoyl-CoA isomerase) to the corresponding Δ^2 -*trans*-CoA stage of β -oxidation for subsequent hydration and oxidation. Any Δ^4 -*cis*-acyl-CoA either remaining, as in the case of linoleic acid, or entering the pathway at this point after conversion by acyl-CoA dehydrogenase to Δ^2 -*trans*- Δ^4 -*cis*-dienoyl-CoA, is then metabolized as indicated in **Figure 22–4**.

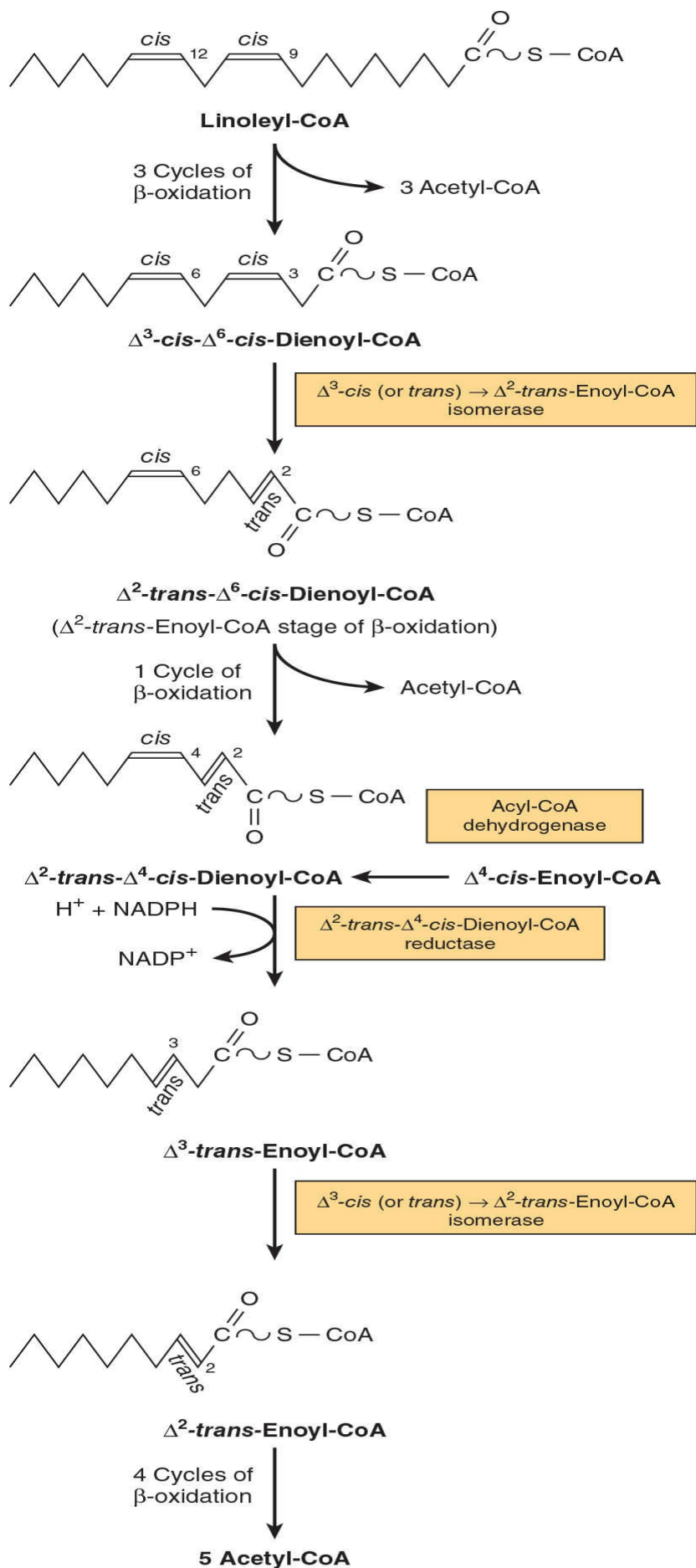

FIGURE 22–4 Sequence of reactions in the oxidation of unsaturated fatty acids, for example, linoleic acid. Δ^4 -*cis*-fatty acids or fatty acids forming Δ^4 -*cis*-enoyl-CoA enter the pathway at the position shown. NADPH for the dienoyl-CoA reductase step is supplied by intramitochondrial sources such as glutamate dehydrogenase, isocitrate dehydrogenase, and NAD(P)H transhydrogenase.

KETOGENESIS OCCURS WHEN THERE IS A HIGH RATE OF FATTY ACID OXIDATION IN THE LIVER

Under metabolic conditions associated with a high rate of fatty acid oxidation, the liver produces considerable quantities of **acetoacetate** and **D-3-hydroxybutyrate** (β -hydroxybutyrate). Acetoacetate continually undergoes spontaneous decarboxylation to yield **acetone**. These three substances are collectively known as the **ketone bodies** (also called acetone bodies or [incorrectly*] “ketones”) (**Figure 22–5**). Acetoacetate and 3-hydroxybutyrate are interconverted by the mitochondrial enzyme **D-3-hydroxybutyrate dehydrogenase**; the equilibrium is controlled by the mitochondrial $[NAD^+]/[NADH]$ ratio, that is, the **redox state**. The concentration of total ketone bodies in the blood of well-fed mammals does not normally exceed 0.2 mmol/L. However, in ruminants, 3-hydroxybutyrate is formed continuously from butyric acid (a product of ruminal fermentation) in the rumen wall. In nonruminants, the liver appears to be the only organ that adds significant quantities of ketone bodies to the blood. Extrahepatic tissues utilize acetoacetate and 3-hydroxybutyrate as respiratory substrates. Acetone is a waste product which, as it is volatile, can be excreted via the lungs. Because there is active synthesis but little utilization of ketone bodies in the liver, while they are used but not produced in extrahepatic tissues, there is a net flow of the compounds to the extrahepatic tissues (**Figure 22–6**).

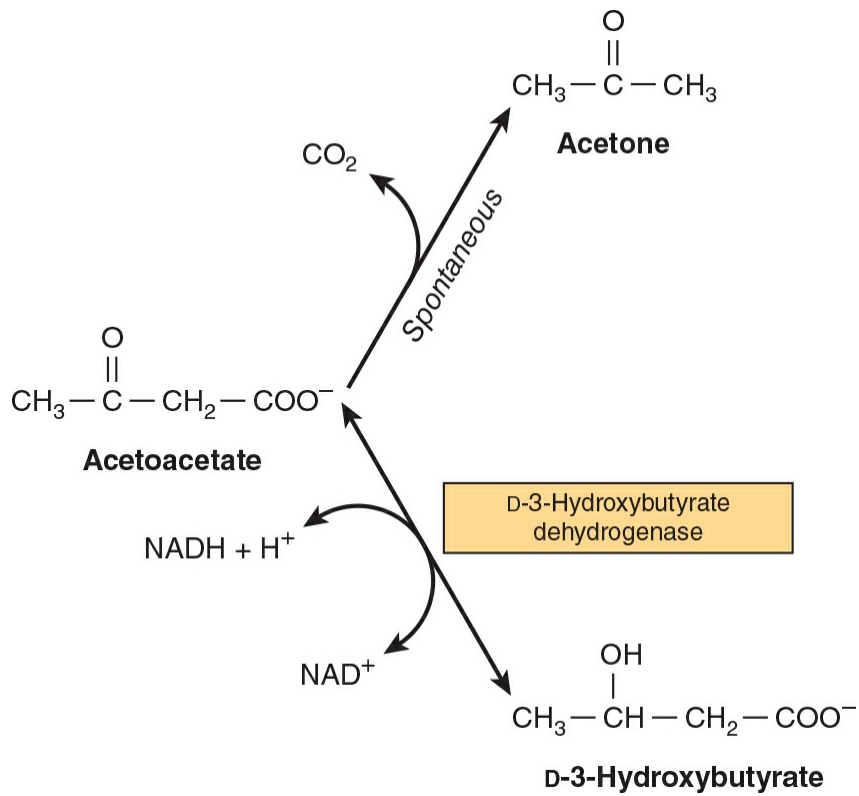

FIGURE 22–5 Interrelationships of the ketone bodies. D-3-Hydroxybutyrate dehydrogenase is a mitochondrial enzyme.

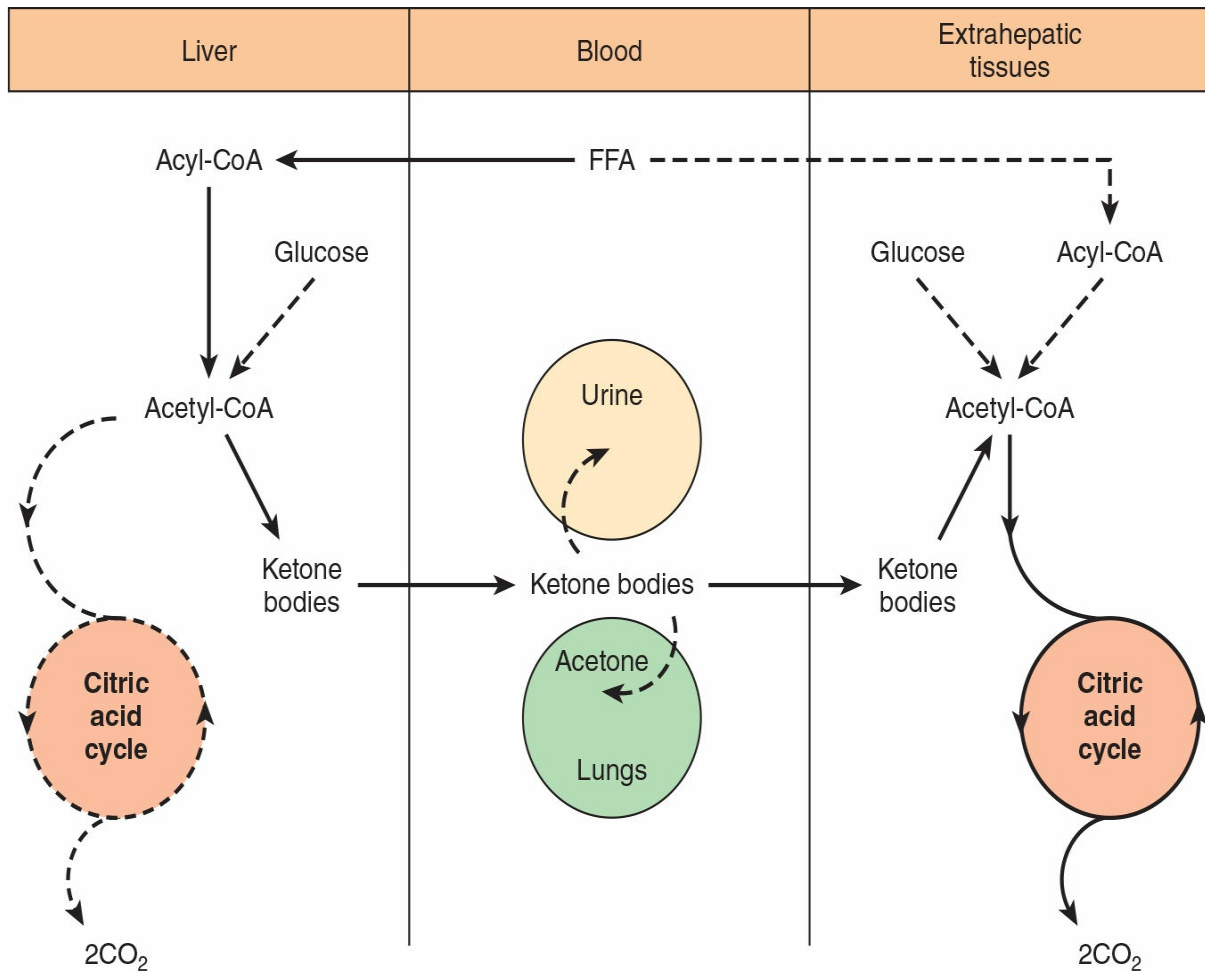

FIGURE 22–6 Formation, utilization, and excretion of ketone bodies. (The main pathway is indicated by the solid arrows.)

Acetoacetyl-CoA Is the Substrate for Ketogenesis

The enzymes responsible for ketone body formation (ketogenesis) are associated mainly with the mitochondria. Acetoacetyl-CoA is formed when two acetyl-CoA molecules produced via fatty acid breakdown condense to form acetoacetyl-CoA by a reversal of the **thiolase** reaction (Figure 22–3), and may also arise directly from the terminal four carbons of a fatty acid during β -oxidation (Figure 22–7). Condensation of acetoacetyl-CoA with another molecule of acetyl-CoA by **3-hydroxy-3-methylglutaryl-CoA (HMG-CoA) synthase** forms **HMG-CoA**. **HMG-CoA lyase** then causes acetyl-CoA to split off from the HMG-CoA, leaving free acetoacetate. **Both enzymes must be present in mitochondria for ketogenesis to take place.** In mammals, ketone bodies are formed solely in the liver and in the rumen epithelium. D-3-Hydroxybutyrate is quantitatively the predominant ketone body present in

the blood and urine in ketosis.

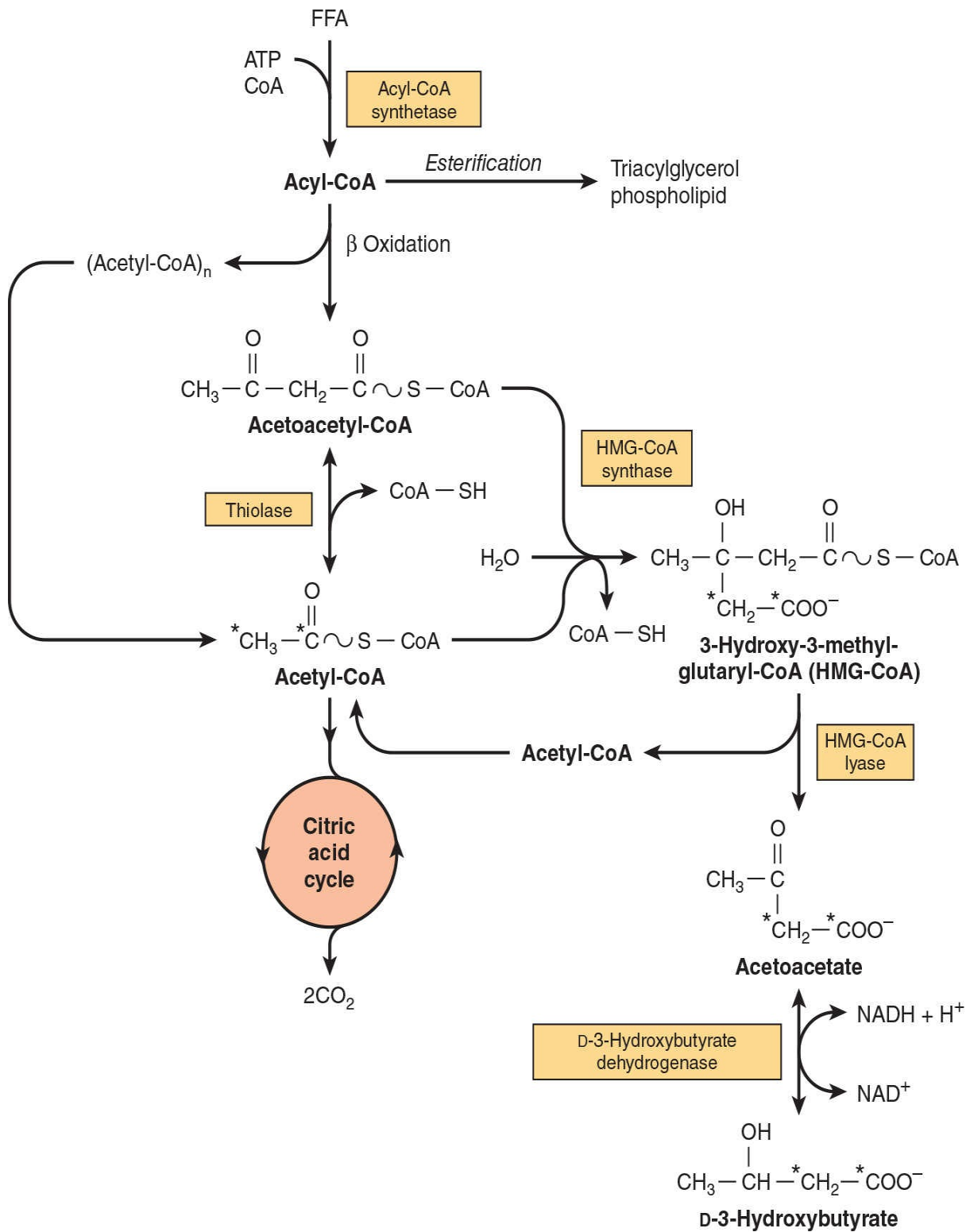

FIGURE 22-7 Pathways of ketogenesis in the liver. (FFA, free fatty acids.)

Ketone Bodies Serve as a Fuel for Extrahepatic Tissues

While an active enzymatic mechanism produces acetoacetate from acetoacetyl-CoA in the liver, acetoacetate once formed can only be reactivated directly in the cytosol, where it is used in a different, much less active pathway as a precursor in cholesterol synthesis (see [Chapter 26](#)). This accounts for the net production of ketone bodies by the liver.

In extrahepatic tissues, acetoacetate is activated to acetoacetyl-CoA by **succinyl-CoA-acetoacetate-CoA transferase**. CoA is transferred from succinyl-CoA to form acetoacetyl-CoA ([Figure 22–8](#)). In a reaction requiring the addition of a CoA, two acetyl-CoA molecules are formed by the splitting of acetoacetyl-CoA by thiolase and these are oxidized in the citric acid cycle. 1 mol of acetoacetate or 3-hydroxybutyrate yields 19 or 21.5 mol of ATP, respectively, by these pathways. If the blood level of ketone bodies rises to a concentration of ~12 mmol/L, the oxidative machinery becomes saturated and at this stage, a large proportion of oxygen consumption may be accounted for by their oxidation.

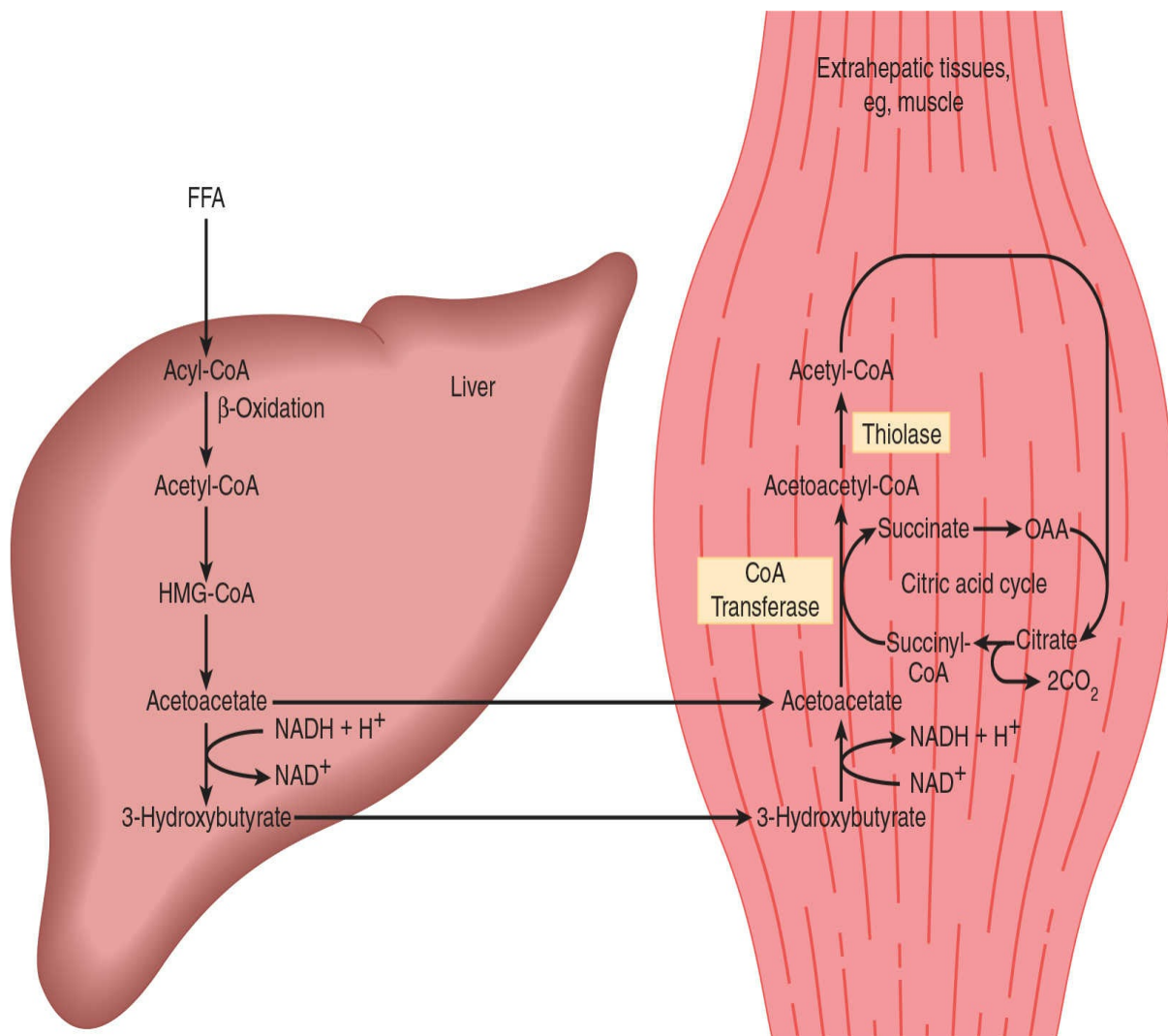

FIGURE 22–8 Transport of ketone bodies from the liver and pathways of utilization and oxidation in extrahepatic tissues.

In moderate ketonemia, the loss of ketone bodies via the urine is only a few percent of the total ketone body production and utilization. Since there are renal threshold-like effects (there is not a true threshold) that vary between species and individuals, measurement of the ketonemia, not the ketonuria, is the preferred method of assessing the severity of ketosis.

KETOGENESIS IS REGULATED AT THREE CRUCIAL STEPS

1. Ketosis does not occur in vivo unless there is an increase in the level of circulating FFAs arising from lipolysis of triacylglycerol in adipose tissue. **FFAs are the precursors of ketone bodies in the liver.** Both in fed and in fasting conditions, the liver extracts ~30% of the FFAs

passing through it, so that at high concentrations the flux passing into the organ is substantial. **Thus, the factors regulating mobilization of FFA from adipose tissue are important in controlling ketogenesis (Figures 22–9 and 25–8).**

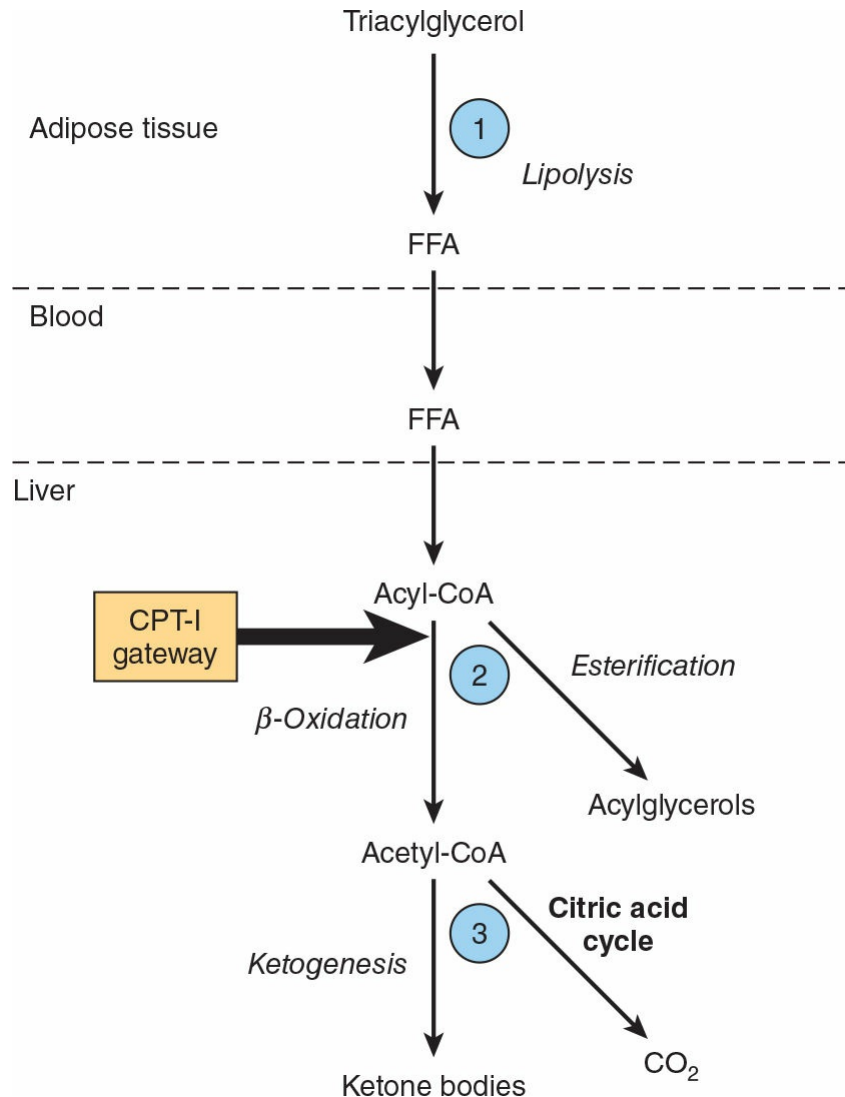

FIGURE 22–9 Regulation of ketogenesis. Symbol ① to Symbol ③ show three crucial steps in the pathway of metabolism of free fatty acids (FFA) that determine the magnitude of ketogenesis. (CPT-I, carnitine palmitoyltransferase-I.)

- After uptake by the liver, FFAs are either **oxidized** to CO_2 or ketone bodies or **esterified** to triacylglycerol and phospholipid. There is regulation of entry of fatty acids into the oxidative pathway by **carnitine palmitoyltransferase-I (CPT-I)** (Figure 22–1), and the remainder of the fatty acid taken up is esterified. CPT-I activity is low in the fed state, leading to depression of fatty acid oxidation, and high

in starvation, allowing fatty acid oxidation to increase. **Malonyl-CoA**, the initial intermediate in fatty acid biosynthesis (see [Figure 23–1](#)) is a potent inhibitor of CPT-I ([Figure 22–10](#)). In the fed state, therefore, FFAs enter the liver cell in low concentrations and are nearly all esterified to acylglycerols and transported out of the liver in **very-low-density lipoproteins (VLDLs)**. However, as the concentration of FFA increases with the onset of starvation, acetyl-CoA carboxylase is inhibited directly by acyl-CoA, and (malonyl-CoA) decreases, releasing the inhibition of CPT-I and allowing more acyl-CoA to be β -oxidized. These events are reinforced in starvation by a decrease in the **(insulin)/(glucagon) ratio**. Thus, β -oxidation from FFA is controlled by the CPT-I gateway into the mitochondria, and the balance of the FFA uptake not oxidized is esterified.

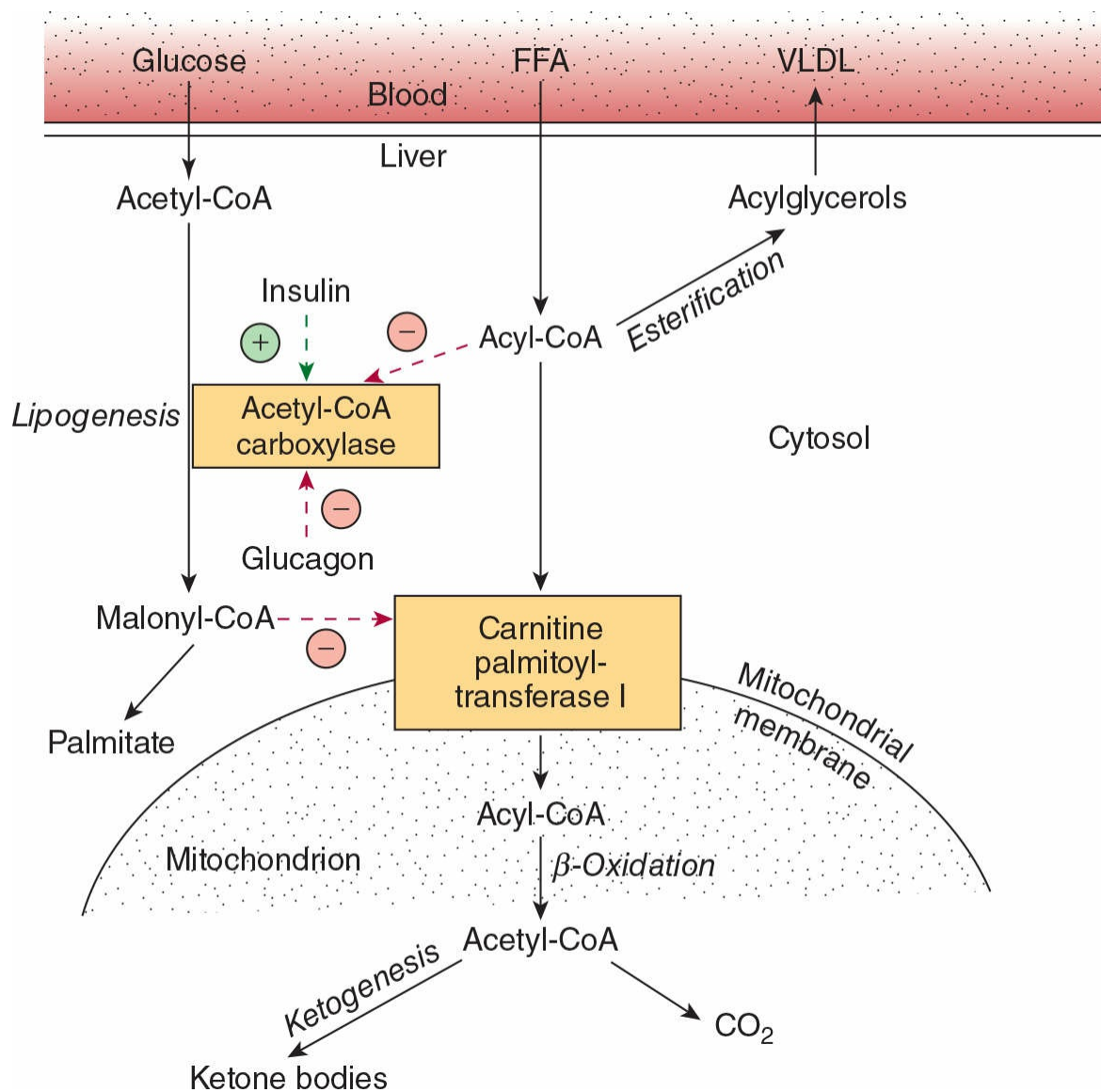

FIGURE 22–10 Regulation of long-chain fatty acid oxidation in the liver. (FFA, free fatty acids; VLDL, very-low-density lipoprotein.) Positive (\oplus) and negative (\ominus) regulatory effects are represented by broken arrows and substrate flow by solid arrows.

3. In turn, the acetyl-CoA formed in β -oxidation is oxidized in the citric acid cycle, or it enters the pathway of ketogenesis via acetoacetyl-CoA to form ketone bodies. As the level of serum FFA is raised, proportionately more of the acetyl-CoA produced from their breakdown is converted to ketone bodies and less is oxidized via the citric acid cycle to CO_2 . The partition of acetyl-CoA between the ketogenic pathway and the pathway of oxidation to CO_2 is regulated so that the total free energy captured in ATP which results from the oxidation of FFA remains constant as their concentration in the serum changes. This may be appreciated when it is realized that complete oxidation of 1 mol of palmitate involves a net production of 106 mol of ATP via β -oxidation and the citric acid cycle (see above), whereas only 26 mol of ATP are produced when acetoacetate is the end product and only 16 mol when 3-hydroxybutyrate is the end product. Thus, ketogenesis may be regarded as a mechanism that allows the liver to oxidize increasing quantities of fatty acids within the constraints of a tightly coupled system of oxidative phosphorylation.

A fall in the concentration of oxaloacetate, particularly within the mitochondria, can impair the ability of the citric acid cycle to metabolize acetyl-CoA and divert fatty acid oxidation toward ketogenesis. Such a fall may occur because of an increase in the $(\text{NADH})/(\text{NAD}^+)$ ratio caused when increased β -oxidation alters the equilibrium between oxaloacetate and malate so that the concentration of oxaloacetate is decreased, and also when gluconeogenesis is elevated due to low blood glucose levels. The activation by acetyl-CoA of pyruvate carboxylase, which catalyzes the conversion of pyruvate to oxaloacetate, partially alleviates this problem, but in conditions such as starvation and untreated diabetes mellitus, ketone bodies are overproduced and cause ketosis.

CLINICAL ASPECTS

Impaired Oxidation of Fatty Acids Gives Rise to Diseases Often Associated With Hypoglycemia

Carnitine deficiency can occur particularly in the newborn—and especially in preterm infants—owing to inadequate biosynthesis or renal leakage. Losses can also occur in hemodialysis. This suggests there may be a vitamin-like dietary requirement for carnitine in some individuals. Symptoms of deficiency include hypoglycemia, which is a consequence of impaired fatty acid oxidation, and lipid accumulation with muscular weakness. Treatment is by oral supplementation with carnitine.

Inherited **CPT-I deficiency** affects only the liver, resulting in reduced fatty acid oxidation and ketogenesis, with hypoglycemia. **CPT-II deficiency** affects primarily skeletal muscle and, when severe, the liver. The sulfonylurea drugs (**glyburide [glibenclamide]** and **tolbutamide**), used in the treatment of type 2 diabetes mellitus, reduce fatty acid oxidation and, therefore, hyperglycemia by inhibiting CPT-I.

Inherited defects in the enzymes of β -oxidation and ketogenesis also lead to nonketotic hypoglycemia, coma, and fatty liver. Defects have been identified in long- and short-chain 3-hydroxyacyl-CoA dehydrogenase (deficiency of the long-chain enzyme may be a cause of **acute fatty liver of pregnancy**). **3-Ketoacyl-CoA thiolase** and **HMG-CoA lyase deficiency** also affect the degradation of leucine, a ketogenic amino acid (see [Chapter 29](#)).

Jamaican vomiting sickness is caused by eating the unripe fruit of the akee tree, which contains the toxin **hypoglycin**. This inactivates medium- and short-chain acyl-CoA dehydrogenase, inhibiting β -oxidation and causing hypoglycemia. **Dicarboxylic aciduria** is characterized by the excretion of C_6 — C_{10} ω -dicarboxylic acids and by nonketotic hypoglycemia, and is caused by a lack of mitochondrial **medium-chain acyl-CoA dehydrogenase**. **Refsum disease** is a rare neurologic disorder caused by a metabolic defect that results in the accumulation of phytanic acid, which is found in dairy products and ruminant fat and meat. Phytanic acid is thought to have pathologic effects on membrane function, protein prenylation, and gene expression. **Zellweger (cerebrohepatorenal) syndrome** occurs in individuals with a rare inherited absence of peroxisomes in all tissues. They accumulate C_{26} — C_{38} polyenoic acids in brain tissue and also exhibit a generalized loss of peroxisomal functions. The disease causes severe neurologic symptoms, and most patients die in the first year of life.

Ketoacidosis Results From Prolonged Ketosis

Higher than normal quantities of ketone bodies present in the blood or

urine constitute **ketonemia** (hyperketonemia) or **ketonuria**, respectively. The overall condition is called **ketosis**. The basic form of ketosis occurs in **starvation** and involves depletion of available carbohydrate coupled with mobilization of FFA. This general pattern of metabolism is exaggerated to produce the pathologic states found in **diabetes mellitus, the type 2 form of which is increasingly common in Western countries; twin lamb disease; and ketosis in lactating cattle**. Nonpathologic forms of ketosis are found under conditions of high-fat feeding and after severe exercise in the postabsorptive state.

Acetoacetic and 3-hydroxybutyric acids are both moderately strong acids and are buffered when present in blood or other tissues. However, their continual excretion in quantity progressively depletes the alkali reserve, causing **ketoacidosis**. This may be fatal in uncontrolled **diabetes mellitus**.

SUMMARY

- Fatty acid oxidation in mitochondria leads to the generation of large quantities of ATP by a process called β -oxidation that cleaves acetyl-CoA units sequentially from fatty acyl chains. The acetyl-CoA is oxidized in the citric acid cycle, generating further ATP.
- The ketone bodies (acetoacetate, 3-hydroxybutyrate, and acetone) are formed in hepatic mitochondria when there is a high rate of fatty acid oxidation. The pathway of ketogenesis involves synthesis and breakdown of HMG-CoA by two key enzymes: HMG-CoA synthase and HMG-CoA lyase.
- Ketone bodies are important fuels in extrahepatic tissues.
- Ketogenesis is regulated at three crucial steps: (1) control of FFA mobilization from adipose tissue; (2) the activity of carnitine palmitoyltransferase-I in liver, which determines the proportion of the fatty acid flux that is oxidized rather than esterified; and (3) partition of acetyl-CoA between the pathway of ketogenesis and the citric acid cycle.
- Diseases associated with impairment of fatty acid oxidation lead to hypoglycemia, fatty infiltration of organs, and hypoketonemia.
- Ketosis is mild in starvation but severe in diabetes mellitus and ruminant ketosis.

REFERENCES

Eljamil AS: *Lipid Biochemistry: For Medical Sciences*. iUniverse, 2015.

Gurr MI, Harwood JL, Frayn KN et al: *Lipids, Biochemistry, Biotechnology and Health*. Wiley-Blackwell 2016.

Houten SM, Wanders RJA: A general introduction to the biochemistry of mitochondrial fatty acid β -oxidation. *J Inherit Metab Dis* 2010;33:469.

* ΔG for the ATP reaction, as explained in [Chapter 11](#).

*The term ketones should not be used as there are ketones in blood that are not ketone bodies, for example, pyruvate and fructose.

Biosynthesis of Fatty Acids & Eicosanoids

Kathleen M. Botham, PhD, DSc & Peter A. Mayes, PhD, DSc

OBJECTIVES

After studying this chapter, you should be able to:

- Describe the reaction catalyzed by acetyl-CoA carboxylase and understand the mechanisms by which its activity is regulated to control the rate of fatty acid synthesis.
- Outline the structure of the fatty acid synthase multienzyme complex, indicating the sequence of enzymes in the two peptide chains of the homodimer.
- Explain how long-chain fatty acids are synthesized by the repeated condensation of two carbon units, with formation of the 16-carbon palmitate being favored in most tissues, and identify the cofactors required.
- Indicate the sources of reducing equivalents (NADPH) for fatty acid synthesis.
- Explain how fatty acid synthesis is regulated by nutritional status and identify other control mechanisms that operate in addition to modulation of the activity of acetyl-CoA carboxylase.

- Identify the nutritionally essential fatty acids and explain why they cannot be formed in the body.
- Explain how polyunsaturated fatty acids are synthesized by desaturase and elongation enzymes.
- Outline the cyclooxygenase and lipoxygenase pathways responsible for the formation of the various classes of eicosanoids.

BIOMEDICAL IMPORTANCE

Fatty acids are synthesized by an **extramitochondrial system**, which is responsible for the complete synthesis of palmitate from acetyl-CoA in the **cytosol**. In most mammals, glucose is the primary substrate for lipogenesis, but in ruminants it is acetate, the main fuel molecule they obtain from the diet. Critical diseases of the pathway have not been reported in humans. However, inhibition of lipogenesis occurs in type 1 (insulin-dependent) **diabetes mellitus**, and variations in the activity of the process affect the nature and extent of **obesity**.

Unsaturated fatty acids in phospholipids of the cell membrane are important in maintaining membrane fluidity (see [Chapter 40](#)). A high ratio of polyunsaturated fatty acids to saturated fatty acids (P:S ratio) in the diet is considered to be beneficial in preventing coronary heart disease. Animal tissues have limited capacity for desaturating fatty acids, and require certain dietary polyunsaturated fatty acids derived from plants. These **essential fatty acids** are used to form eicosanoic (C₂₀) fatty acids, which give rise to the **eicosanoids** prostaglandins, thromboxanes, leukotrienes, and lipoxins. Prostaglandins mediate **inflammation, pain**, induce **sleep**, and also regulate **blood coagulation** and **reproduction**. **Nonsteroidal anti-inflammatory drugs (NSAIDs)** such as **aspirin and ibuprofen** act by inhibiting prostaglandin synthesis. Leukotrienes have muscle contractant and chemotactic properties and are important in allergic reactions and inflammation.

THE MAIN PATHWAY FOR DE NOVO SYNTHESIS OF FATTY ACIDS (LIPOGENESIS) OCCURS IN THE CYTOSOL

This system is present in many tissues, including liver, kidney, brain, lung, mammary gland, and adipose tissue. Its cofactor requirements include

NADPH, ATP, Mn^{2+} , biotin, and HCO_3^- (as a source of CO_2). **Acetyl-CoA** is the immediate substrate, and **free palmitate** is the end product.

Production of Malonyl-CoA Is the Initial & Controlling Step in Fatty Acid Synthesis

Bicarbonate as a source of CO_2 is required in the initial reaction for the carboxylation of acetyl-CoA to **malonyl-CoA** in the presence of ATP and **acetyl-CoA carboxylase**. This enzyme has a major role in the regulation of fatty acid synthesis (see below). Acetyl-CoA carboxylase has a requirement for the B vitamin **biotin** and is a **multienzyme protein** containing biotin, biotin carboxylase, biotin carboxyl carrier protein, and a carboxyl transferase, as well as a regulatory allosteric site. One subunit of the complex contains all the components, and variable number of subunits form polymers in the active enzyme (see [Figure 23–6](#)). The reaction takes place in two steps: (1) carboxylation of biotin involving ATP and (2) transfer of the carboxyl group to acetyl-CoA to form malonyl-CoA ([Figure 23–1](#)).

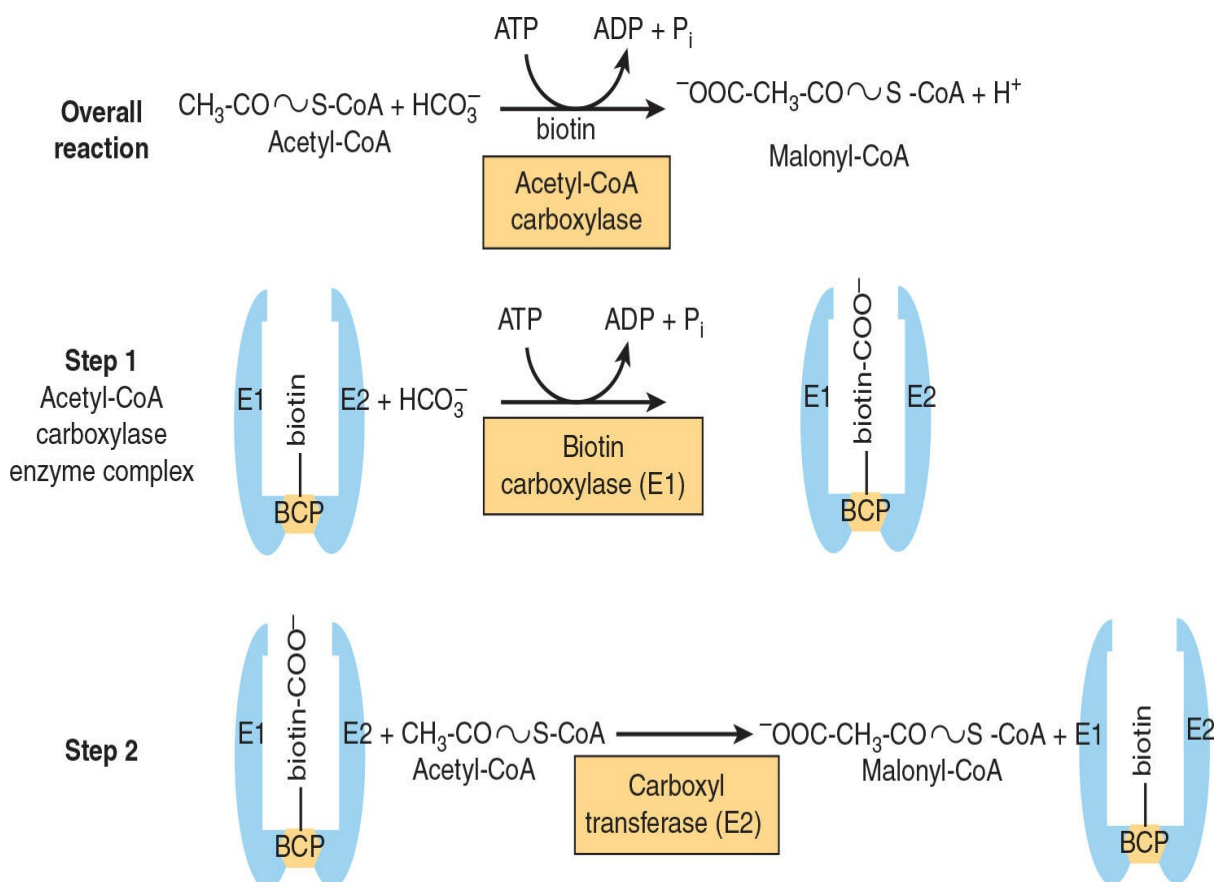
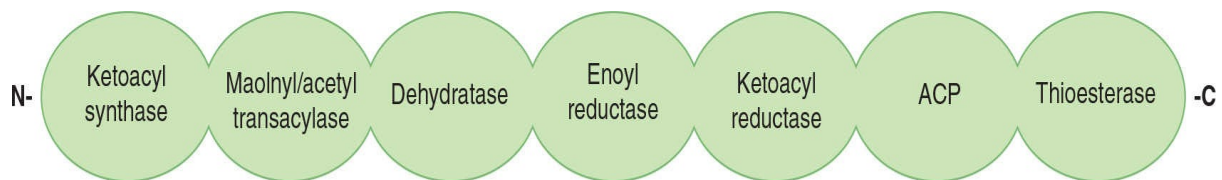

FIGURE 23–1 Biosynthesis of malonyl-CoA by acetyl carboxylase.

Acetyl carboxylase is a multienzyme complex containing two enzymes, biotin carboxylase (E1) and a carboxyltransferase (E2) and the biotin carrier protein (BCP). Biotin is covalently linked to the BCP. The reaction proceeds in two steps. In step 1, catalysed by E1, biotin is carboxylated as it accepts a COO^- group from HCO_3^- and ATP is used. In step 2, catalyzed by E2, the COO^- is transferred to acetyl-CoA forming malonyl-CoA.

The Fatty Acid Synthase Complex Is a Homodimer of Two Polypeptide Chains Containing Six Enzyme Activities and the Acyl Carrier Protein

After the formation of malonyl-CoA, fatty acids are formed by the **fatty acid synthase enzyme complex**. The individual enzymes required for fatty acid synthesis are linked in this multienzyme polypeptide complex that incorporates the **acyl carrier protein (ACP)**, which has a similar function to that of CoA in the β -oxidation pathway (see [Chapter 22](#)) It contains the vitamin **pantothenic acid** in the form of 4'-phosphopantetheine (see [Figure 44–15](#)). In the primary structure of the protein, the enzyme domains are linked in the sequence as shown in [Figure 23–2](#). X-ray crystallography of the three-dimensional structure, however, has shown that the complex is a homodimer, with two identical subunits, each containing six enzymes and an ACP, arranged in an X shape ([Figure 23–2](#)). The use of one multienzyme functional unit has the advantages of achieving compartmentalization of the process within the cell without the necessity for permeability barriers, and synthesis of all enzymes in the complex is coordinated since it is encoded by a single gene.



Sequence of enzyme domains in primary structure of fatty acid synthase monomer

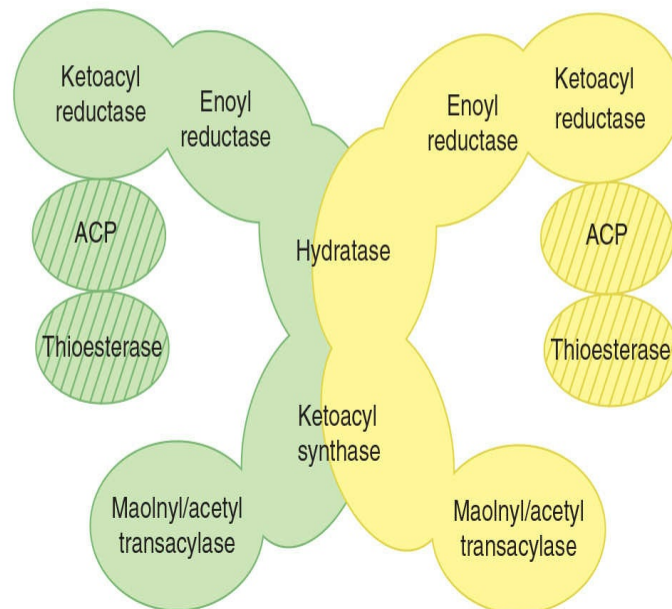

Fatty acid synthase homodimer

FIGURE 23–2 Fatty acid synthase multienzyme complex. The complex is a dimer of two identical polypeptide monomers in which six enzymes and the acyl carrier protein (ACP) are linked in the primary structure in the sequence shown. X-ray crystallography of the three-dimensional structure has demonstrated that the two monomers in the complex are arranged in an X-shape.

Initially, a priming molecule of acetyl-CoA combines with a cysteine —SH group (**Figure 23–3**, reaction 1a), while malonyl-CoA combines with the adjacent —SH on the 4'-phosphopantetheine of ACP of the other monomer (reaction 1b). These reactions are catalyzed by **malonyl acetyl transacylase**, to form **acetyl (acyl)-malonyl enzyme**. The acetyl group attacks the methylene group of the malonyl residue, catalyzed by **3-ketoacyl synthase**, and liberates CO_2 , forming **3-ketoacyl enzyme** (acetoacetyl enzyme) (reaction 2), freeing the cysteine —SH group. Decarboxylation allows the reaction to go to completion, pulling the whole sequence of reactions in the forward direction. The 3-ketoacyl group is reduced, dehydrated, and reduced again (reactions 3-5) to form the corresponding **saturated acyl enzyme** (product of reaction 5). A new

malonyl-CoA molecule combines with the —SH of 4'-phosphopantetheine, displacing the saturated acyl residue onto the free cysteine —SH group. The sequence of reactions is repeated six more times until a saturated 16-carbon acyl radical (palmitoyl) has been assembled. It is liberated from the enzyme complex by the activity of the sixth enzyme in the complex, **thioesterase** (deacylase). The free palmitate must be activated to acyl-CoA before it can proceed via any other metabolic pathway. Its possible fates are esterification into acylglycerols, chain elongation, desaturation, or esterification into cholesteryl ester. In mammary gland, there is a separate thioesterase specific for acyl residues of C₈, C₁₀, or C₁₂, which are subsequently found in milk lipids.

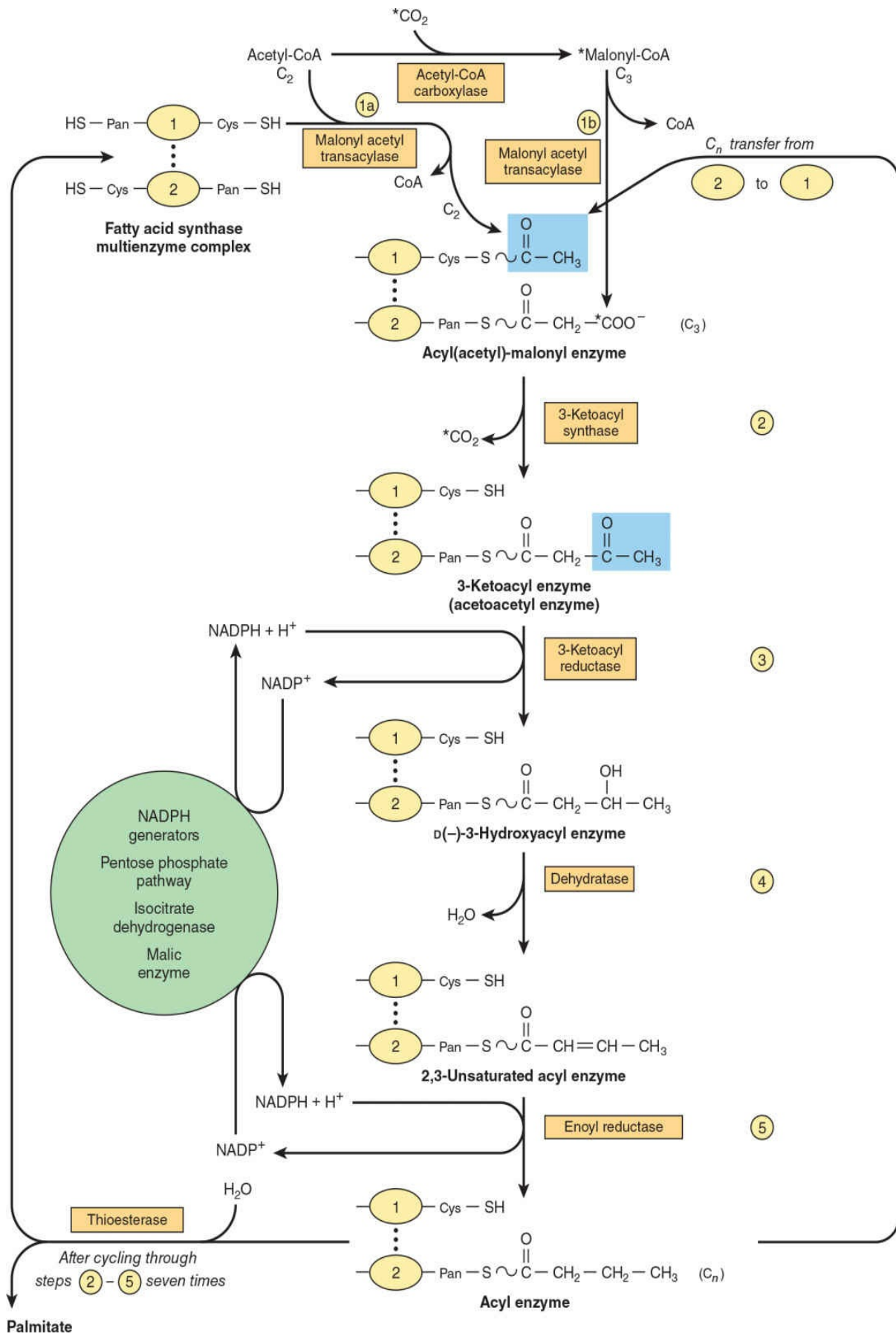

KEY: (1), (2), individual monomers of fatty acid synthase

FIGURE 23–3 Biosynthesis of long-chain fatty acids. After the initial priming step in which acetyl-CoA is bound to a cysteine-SH group on the fatty acid synthase enzyme (reaction 1a) in each cycle the addition of a malonyl residue causes the acyl chain to grow by two carbon atoms. (Cys, cysteine residue; Pan, 4'-phosphopantetheine.) The blocks highlighted in blue contain initially a C₂ unit derived from acetyl-CoA (as illustrated) and subsequently the C_n unit formed in reaction 5.

*Shows that the carbon in the CO₂ initially incorporated into malonyl-CoA is then released as CO₂ in reaction 2.

The equation for the overall synthesis of palmitate from acetyl-CoA and malonyl-CoA is

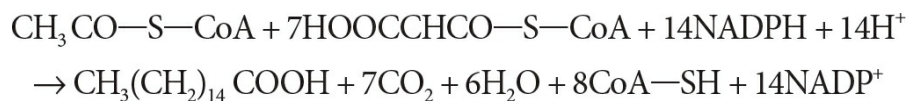

The acetyl-CoA used as a primer forms carbon atoms 15 and 16 of palmitate. The addition of all the subsequent C₂ units is via malonyl-CoA. Propionyl-CoA instead of acetyl-CoA is used as the primer for the synthesis of long-chain fatty acids with an odd number of carbon atoms, which are found particularly in ruminant fat and milk.

The Main Source of NADPH for Lipogenesis Is the Pentose Phosphate Pathway

NADPH is involved as a donor of reducing equivalents in the reduction of the 3-ketoacyl and the 2,3-unsaturated acyl derivatives (Figure 23–3, reactions 3 and 5). The oxidative reactions of the pentose phosphate pathway (see Chapter 20) are the chief source of the hydrogen required for the synthesis of fatty acids. Significantly, tissues specializing in active lipogenesis—that is, liver, adipose tissue, and the lactating mammary gland—also possess an active pentose phosphate pathway. Moreover, both metabolic pathways are found in the cytosol of the cell, so there are no membranes or permeability barriers against the transfer of NADPH. Other sources of NADPH include the reaction that converts malate to pyruvate catalyzed by the **NADP malate dehydrogenase (malic enzyme)** (Figure 23–4) and the extramitochondrial **isocitrate dehydrogenase** reaction (a substantial source in ruminants).

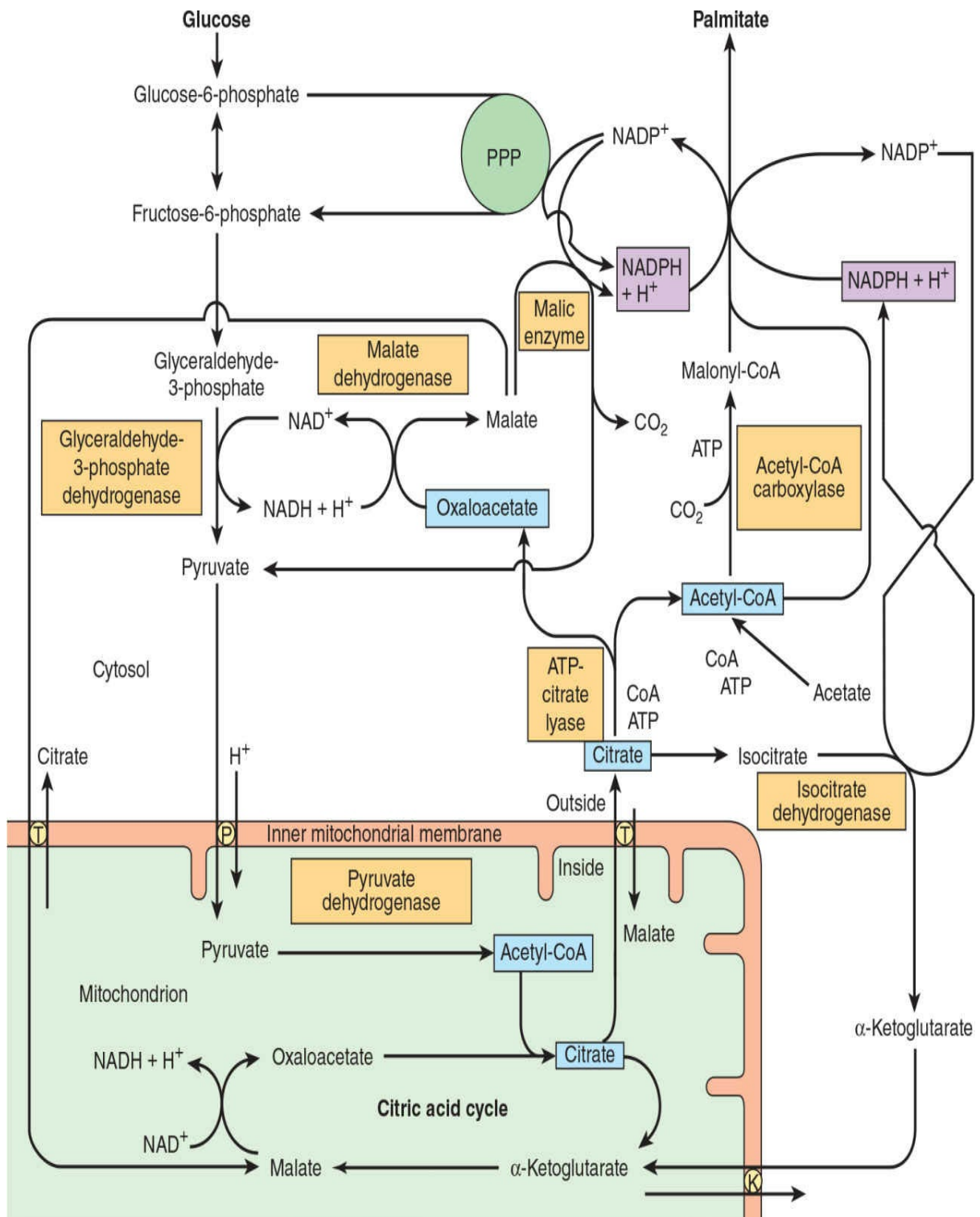

FIGURE 23–4 The provision of acetyl-CoA and NADPH for lipogenesis. (K, α-ketoglutarate transporter; P, pyruvate transporter; PPP, pentose phosphate pathway; T, tricarboxylate transporter.)

Acetyl-CoA Is the Principal Building Block of Fatty Acids

Acetyl-CoA is formed from glucose via the oxidation of pyruvate in the matrix of the mitochondria (see [Chapter 17](#)). However, as it does not diffuse readily across the mitochondrial membranes, its transport into the cytosol, the principal site of fatty acid synthesis, requires a special mechanism involving **citrate**. After condensation of acetyl-CoA with oxaloacetate in the citric acid cycle within mitochondria, the citrate produced can be translocated into the extramitochondrial compartment via the tricarboxylate transporter, where in the presence of CoA and ATP, it undergoes cleavage to acetyl-CoA and oxaloacetate by **ATP-citrate lyase**, which increases in activity in the well-fed state. The acetyl-CoA is then available for malonyl-CoA formation and synthesis of fatty acids ([Figures 23–1](#) and [23–3](#)), and the oxaloacetate can form malate via NADH-linked malate dehydrogenase, followed by the generation of NADPH and pyruvate via the malic enzyme. The NADPH becomes available for lipogenesis, and the pyruvate can be used to regenerate acetyl-CoA after transport into the mitochondrion ([Figure 23–4](#)). This pathway is a means of transferring reducing equivalents from extramitochondrial NADH to NADP. Alternatively, malate itself can be transported into the mitochondrion, where it is able to reform oxaloacetate. Note that the citrate (tricarboxylate) transporter in the mitochondrial membrane requires malate to exchange with citrate (see [Figure 13–10](#)). There is little ATP-citrate lyase or malic enzyme in ruminants, probably because in these species acetate (derived from carbohydrate digestion in the rumen and activated to acetyl-CoA extramitochondrially) is the main source of acetyl-CoA.

Elongation of Fatty Acid Chains Occurs in the Endoplasmic Reticulum

This pathway (the “**microsomal system**”) elongates saturated and unsaturated fatty acyl-CoAs (from C₁₀ upward) by two carbons, using malonyl-CoA as the acetyl donor and NADPH as the reductant, and is catalyzed by the microsomal **fatty acid elongase** system of enzymes ([Figure 23–5](#)). Elongation of stearyl-CoA in brain increases rapidly during myelination in order to provide C₂₂ and C₂₄ fatty acids for sphingolipids.

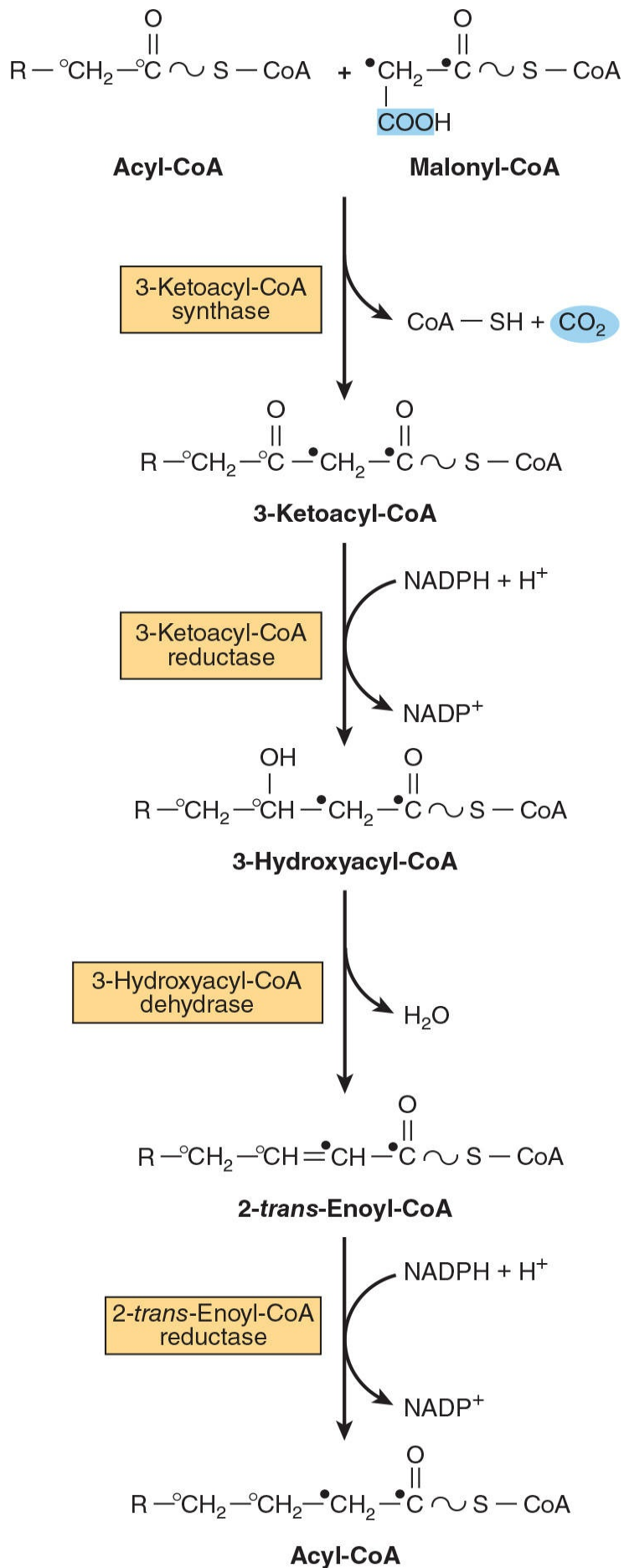

FIGURE 23–5 Microsomal elongase system for fatty acid chain elongation. NADH may also be used by the reductases, but NADPH is preferred.

THE NUTRITIONAL STATE REGULATES LIPOGENESIS

Excess carbohydrate is stored as fat in many animals in anticipation of periods of caloric deficiency such as starvation, hibernation, etc, and to provide energy for use between meals in animals, including humans, that take their food at spaced intervals. Lipogenesis converts surplus glucose and intermediates such as pyruvate, lactate, and acetyl-CoA to fat, assisting the anabolic phase of this feeding cycle. The nutritional state of the organism is the main factor regulating the rate of lipogenesis. Thus, the rate is high in the well-fed animal whose diet contains a high proportion of carbohydrate. It is depressed by restricted caloric intake, high-fat diet, or a deficiency of insulin, as in diabetes mellitus. These latter conditions are associated with increased concentrations of plasma-free fatty acids, and an inverse relationship has been demonstrated between hepatic lipogenesis and the concentration of serum-free fatty acids. Lipogenesis is increased when sucrose is fed instead of glucose because fructose bypasses the phosphofructokinase control point in glycolysis and floods the lipogenic pathway (see [Figure 20–5](#)).

SHORT- & LONG-TERM MECHANISMS REGULATE LIPOGENESIS

Long-chain fatty acid synthesis is controlled in the short term by allosteric and covalent modification of enzymes and in the long term by changes in gene expression governing rates of synthesis of enzymes.

Acetyl-CoA Carboxylase Is the Most Important Enzyme in the Regulation of Lipogenesis

Acetyl-CoA carboxylase is an allosteric enzyme and is activated by **citrate**, which increases in concentration in the well-fed state and is an indicator of a plentiful supply of acetyl-CoA. Citrate promotes the conversion of the enzyme from an inactive dimer (two subunits of the enzyme complex) to an active polymeric form, with a molecular mass of

several million. Inactivation is promoted by phosphorylation of the enzyme and by long-chain acyl-CoA molecules, an example of negative feedback inhibition by a product of a reaction (**Figure 23–6**). Thus, if acyl-CoA accumulates because it is not esterified quickly enough or because of increased lipolysis or an influx of free fatty acids into the tissue, it will automatically reduce the synthesis of new fatty acid. Acyl-CoA also inhibits the mitochondrial **tricarboxylate transporter**, thus preventing activation of the enzyme by egress of citrate from the mitochondria into the cytosol (**Figure 23–6**).

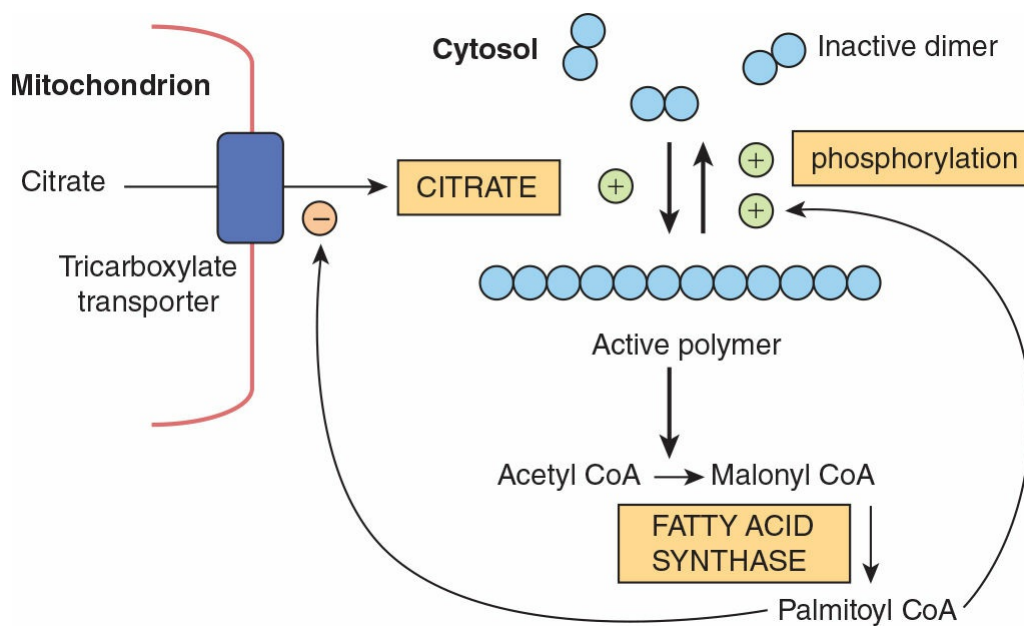

FIGURE 23–6 Regulation of acetyl-CoA carboxylase. Acetyl-CoA carboxylase is activated by citrate, which promotes the conversion of the enzyme from an inactive dimer to an active polymeric form. Inactivation is promoted by phosphorylation of the enzyme and by long-chain acyl-CoA molecules such as palmitoyl-CoA. In addition, acyl-CoA inhibits the tricarboxylate transporter, which transports citrate out of mitochondria into the cytosol, thus decreasing the citrate concentration in the cytosol and favoring inactivation of the enzyme.

Acetyl-CoA carboxylase is also regulated by hormones such as **glucagon**, **epinephrine**, and **insulin** via changes in its phosphorylation state (details in **Figure 23–7**).

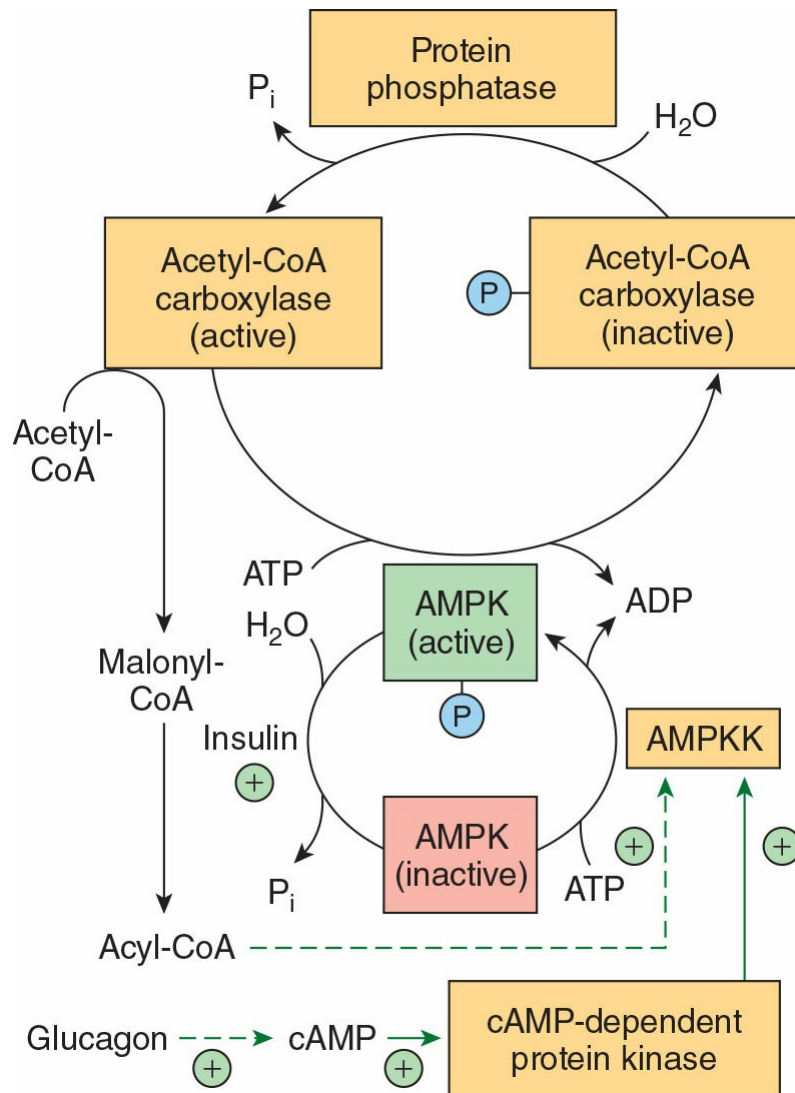

FIGURE 23–7 Regulation of acetyl-CoA carboxylase by phosphorylation/dephosphorylation. The enzyme is inactivated by phosphorylation by AMP-activated protein kinase (AMPK), which in turn is phosphorylated and activated by AMP-activated protein kinase kinase (AMPKK). Glucagon and epinephrine increase cAMP, and thus activate this latter enzyme via cAMP-dependent protein kinase. The kinase kinase enzyme is also believed to be activated by acyl-CoA. Insulin activates acetyl-CoA carboxylase via dephosphorylation of AMPK.

Pyruvate Dehydrogenase Is Also Regulated by Acyl-CoA

Acyl-CoA causes an inhibition of pyruvate dehydrogenase by inhibiting the ATP-ADP exchange transporter of the inner mitochondrial membrane, which leads to increased intramitochondrial (ATP)/(ADP) ratios and

therefore to conversion of active to inactive pyruvate dehydrogenase (see [Figure 17–6](#)), thus regulating the availability of acetyl-CoA for lipogenesis. Furthermore, oxidation of acyl-CoA due to increased levels of free fatty acids may increase the ratios of (acetyl-CoA)/(CoA) and (NADH)/(NAD⁺) in mitochondria, inhibiting pyruvate dehydrogenase.

Insulin Also Regulates Lipogenesis by Other Mechanisms

Insulin stimulates lipogenesis by several other mechanisms as well as by increasing acetyl-CoA carboxylase activity. It increases the transport of glucose into the cell (eg, in adipose tissue), increasing the availability of both pyruvate for fatty acid synthesis and glycerol-3-phosphate for triacylglycerol synthesis via esterification of the newly formed fatty acids (see [Figure 24–2](#)), and also converts the inactive form of pyruvate dehydrogenase to the active form in adipose tissue, but not in liver. Insulin also—by its ability to depress the level of intracellular cAMP—**inhibits lipolysis** in adipose tissue, reducing the concentration of plasma-free fatty acids and, therefore, long-chain acyl-CoA, which are inhibitors of lipogenesis.

The Fatty Acid Synthase Complex & Acetyl-CoA Carboxylase Are Adaptive Enzymes

These enzymes adapt to the body's physiologic needs via changes in gene expression which lead to increases in the total amount of enzyme protein present in the fed state and decreases during intake of a high-fat diet and in conditions such as starvation, and diabetes mellitus. **Insulin** plays an important role, promoting gene expression and induction of enzyme biosynthesis, and **glucagon** (via cAMP) antagonizes this effect. Feeding fats containing polyunsaturated fatty acids coordinately regulates the inhibition of expression of key enzymes of glycolysis and lipogenesis. These mechanisms for longer-term regulation of lipogenesis take several days to become fully manifested and augment the direct and immediate effect of free fatty acids and hormones such as insulin and glucagon.

SOME POLYUNSATURATED FATTY ACIDS CANNOT BE SYNTHESIZED BY MAMMALS & ARE NUTRITIONALLY ESSENTIAL

Certain long-chain unsaturated fatty acids of metabolic significance in mammals are shown in **Figure 23–8**. Other C₂₀, C₂₂, and C₂₄ polyenoic fatty acids may be derived from oleic, linoleic, and α -linolenic acids by chain elongation. Palmitoleic and oleic acids are not essential in the diet because the tissues can introduce a double bond at the Δ^9 position of a saturated fatty acid. **Linoleic** and **α -linolenic acids** are the only fatty acids known to be essential for the complete nutrition of many species of animals, including humans, and are termed the **nutritionally essential fatty acids**. In humans and most other mammals, **arachidonic acid** can be formed from linoleic acid. Double bonds can be introduced at the Δ^4 , Δ^5 , Δ^6 , and Δ^9 positions (see **Chapter 21**) in most animals, but never beyond the Δ^9 position. In contrast, plants are able to synthesize the nutritionally essential fatty acids by introducing double bonds at the Δ^{12} and Δ^{15} positions.



Palmitoleic acid ($\omega 7$, 16:1, Δ^9)

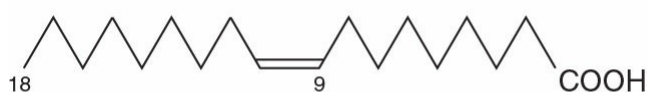

Oleic acid ($\omega 9$, 18:1, Δ^9)

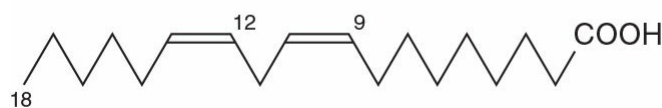

***Linoleic acid ($\omega 6$, 18:2, $\Delta^{9,12}$)**

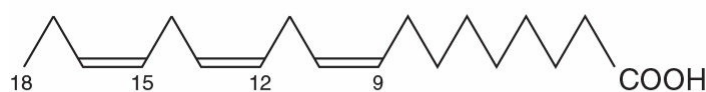

*** α -Linolenic acid ($\omega 3$, 18:3, $\Delta^{9,12,15}$)**

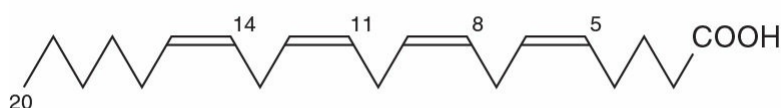

Arachidonic acid ($\omega 6$, 20:4, $\Delta^{5,8,11,14}$)

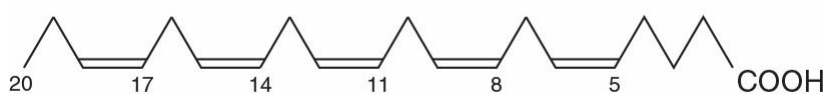

Eicosapentaenoic acid ($\omega 3$, 20:5, $\Delta^{5,8,11,14,17}$)

FIGURE 23–8 Structure of some unsaturated fatty acids. Although the carbon atoms in the molecules are conventionally numbered—that is, numbered from the carboxyl terminal—the ω numbers (eg, $\omega 7$ in palmitoleic acid) are calculated from the reverse end (the methyl terminal) of the molecules. The information in parentheses shows, for instance, that α -linolenic acid contains double bonds starting at the third carbon from the methyl terminal, has 18 carbons and 3 double bonds, and has these double bonds at the 9th, 12th, and 15th carbons from the carboxyl terminal.

*Nutritionally essential fatty acids in humans.

MONOUNSATURATED FATTY ACIDS ARE SYNTHESIZED BY A Δ^9 DESATURASE SYSTEM

Several tissues including the liver are considered to be responsible for the formation of nonessential monounsaturated fatty acids from saturated fatty acids. The first double bond introduced into a saturated fatty acid is nearly always in the Δ^9 position. An enzyme system— Δ^9 desaturase (**Figure 23–9**)—in the endoplasmic reticulum catalyzes the conversion of palmitoyl-CoA or stearoyl-CoA to palmitoleoyl-CoA or oleoyl-CoA, respectively. Oxygen and either NADH or NADPH are necessary for the reaction. The enzymes appear to be similar to a mono-oxygenase system involving cytochrome b_5 (see **Chapter 12**).

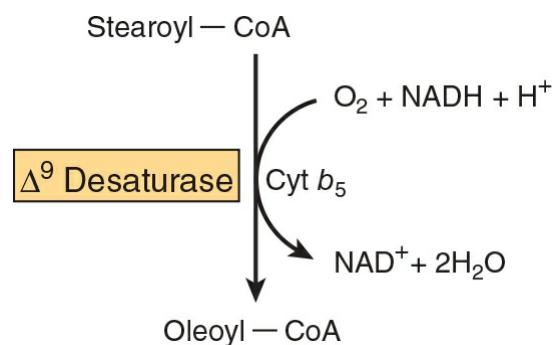

FIGURE 23–9 Microsomal $\delta 9$ desaturase.

SYNTHESIS OF POLYUNSATURATED FATTY ACIDS INVOLVES DESATURASE & ELONGASE ENZYME SYSTEMS

Additional double bonds introduced into existing monounsaturated fatty acids are always separated from each other by a methylene group

(methylene interrupted) except in bacteria. Since animals have a Δ^9 desaturase, they are able to synthesize the $\omega 9$ (oleic acid) family of unsaturated fatty acids completely by a combination of chain elongation and desaturation (Figures 23–9 and 23–10) after the formation of saturated fatty acids by the pathways described in this chapter. However, as indicated above, linoleic ($\omega 6$) or α -linolenic ($\omega 3$) acids are required for the synthesis of the other members of the $\omega 6$ or $\omega 3$ families (pathways shown in Figure 23–10) and must be supplied in the diet. Linoleic acid is converted to arachidonic acid (20:4 $\omega 6$) via **γ -linolenic acid (18:3 $\omega 6$)**. The nutritional requirement for arachidonate may thus be dispensed with if there is adequate linoleate in the diet. Cats, however, cannot carry out this conversion owing to the absence of Δ^6 desaturase and must obtain arachidonate in their diet. The desaturation and chain elongation system are greatly diminished in the starving state, in response to glucagon and epinephrine administration, and in the absence of insulin as in type 1 diabetes mellitus.

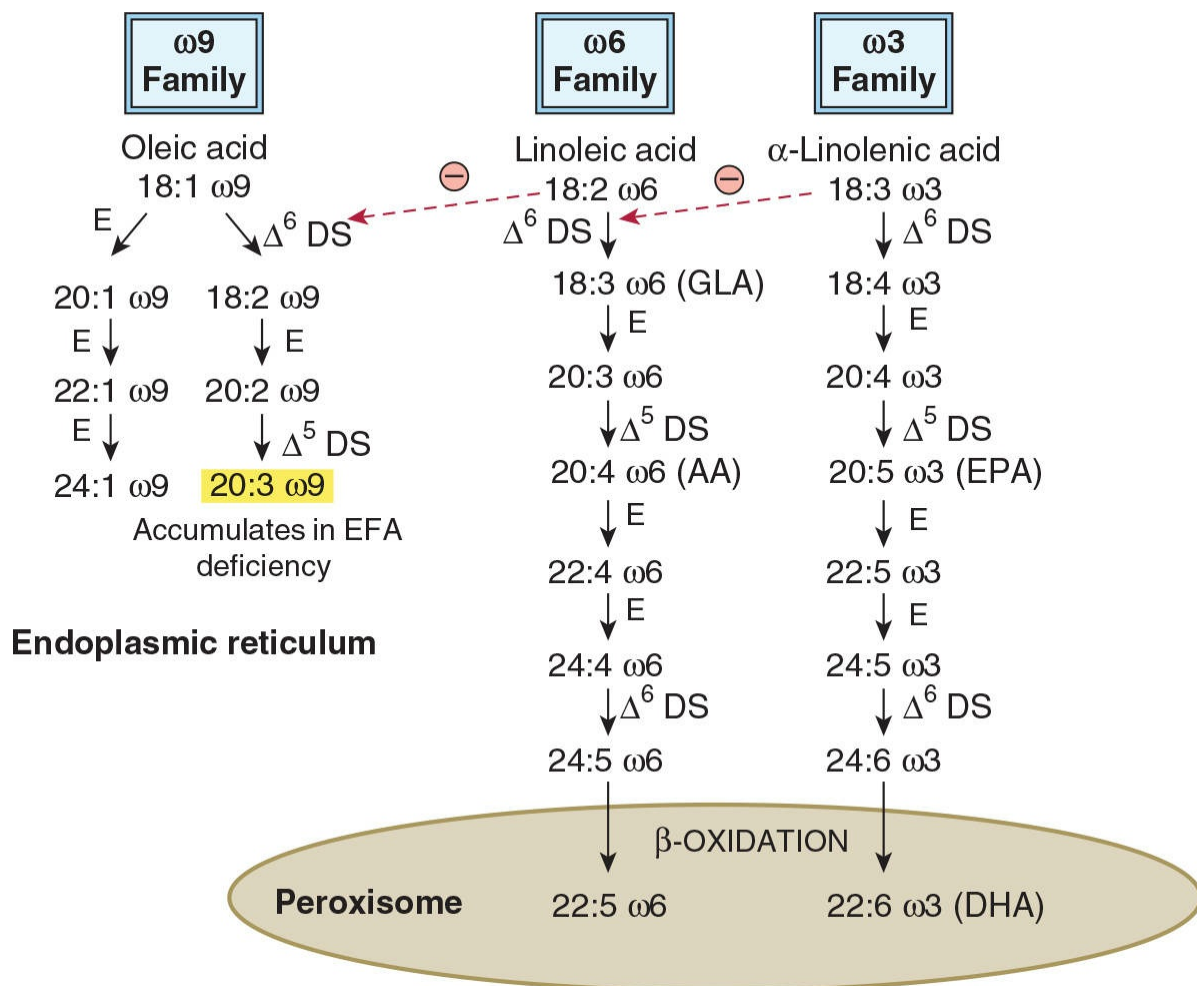

FIGURE 23–10 Biosynthesis of the $\omega 9$, $\omega 6$, and $\omega 3$ families of

polyunsaturated fatty acids. In animals, the ω 9, ω 6, and ω 3 families of polyunsaturated fatty acids are synthesized in the endoplasmic reticulum from oleic, linoleic, and β -linolenic acids, respectively, by a series of elongation and desaturation reactions. The production of 22:5 ω 6 (osbond acid) or 22:6 ω 3 (docosahexanoic acid [DHA]), however, requires one cycle of β -oxidation, which takes place inside peroxisomes after the formation of 24:5 ω 6 or 24:6 ω 3. (AA, arachidonic acid; E, elongase; DS, desaturase; EFA, essential fatty acids; EPA, eicosapentaenoic acid; GLA, γ -linolenic acid; Minus \ominus , inhibition.)

DEFICIENCY SYMPTOMS OCCUR WHEN THE ESSENTIAL FATTY ACIDS (EFA) ARE ABSENT FROM THE DIET

Rats fed a purified nonlipid diet containing vitamins A and D exhibit a reduced growth rate and reproductive deficiency which may be cured by the addition of **linoleic**, **α -linolenic**, and **arachidonic acids** to the diet. These fatty acids are found in high concentrations in vegetable oils (see [Table 21–2](#)) and in small amounts in animal carcasses. Essential fatty acids are required for prostaglandin, thromboxane, leukotriene, and lipoxin formation (see below), and they also have various other functions that are less well defined. They are found in the structural lipids of the cell, often in the position 2 of phospholipids, and are concerned with the structural integrity of the mitochondrial membrane.

Arachidonic acid is present in membranes and accounts for 5 to 15% of the fatty acids in phospholipids. Docosahexaenoic acid (DHA; ω 3, 22:6), which is synthesized to a limited extent from α -linolenic acid or obtained directly from fish oils, is present in high concentrations in retina, cerebral cortex, testis, and sperm. DHA is particularly needed for development of the brain and retina and is supplied via the placenta and milk. Patients with **retinitis pigmentosa** are reported to have low blood levels of DHA. In **essential fatty acid deficiency**, nonessential polyenoic acids of the ω 9 family, particularly $\Delta^{5,8,11}$ -eicosatrienoic acid (ω 9 20:3) ([Figure 23–10](#)), replace the essential fatty acids in phospholipids, other complex lipids, and membranes. The triene:tetraene ratio in plasma lipids can be used to diagnose the extent of essential fatty acid deficiency.

EICOSANOIDS ARE FORMED FROM C₂₀

POLYUNSATURATED FATTY ACIDS

Arachidonate and some other C₂₀ polyunsaturated fatty acids give rise to **eicosanoids**, physiologically and pharmacologically active compounds known as **prostaglandins (PG)**, **thromboxanes (TX)**, **leukotrienes (LT)**, and **lipoxins (LX)** (see [Chapter 21](#)). Physiologically, they are considered to act as local hormones functioning through G-protein–linked receptors to elicit their biochemical effects.

There are three groups of eicosanoids that are synthesized from C₂₀ eicosanoic acids derived from the essential fatty acids **linoleate** and **α-linolenate**, or directly from dietary arachidonate and eicosapentaenoate ([Figure 23–11](#)). Arachidonate, which may be obtained from the diet, but is usually derived from the position 2 of phospholipids in the plasma membrane by the action of phospholipase A₂ ([Figure 24–5](#)), is the substrate for the synthesis of the PG₂, TX₂ series (**prostanoids**) by the **cyclooxygenase pathway**, or the LT₄ and LX₄ series by the **lipoxygenase pathway**, with the two pathways competing for the arachidonate substrate ([Figure 23–11](#)).

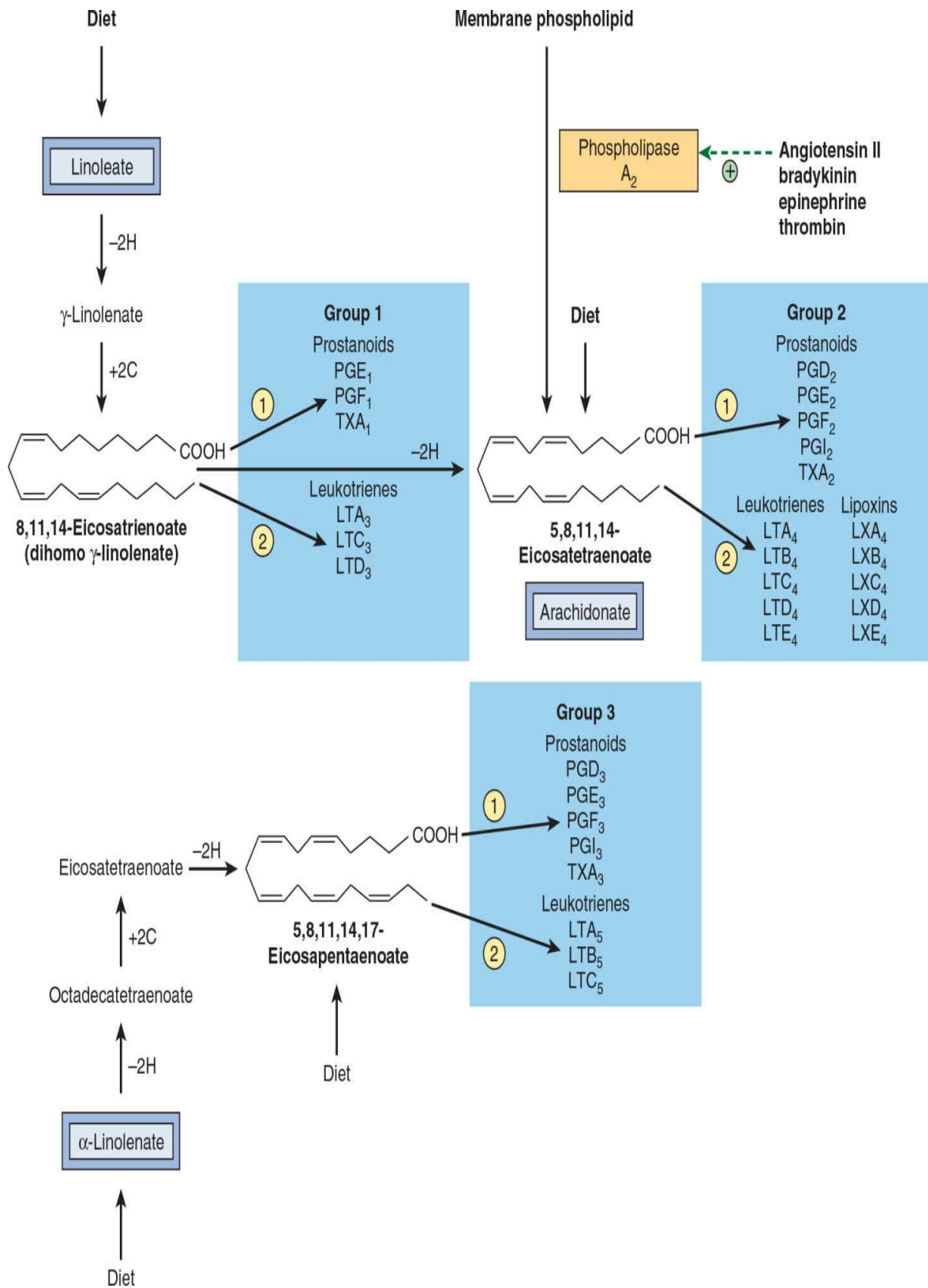

FIGURE 23–11 The three groups of eicosanoids and their biosynthetic origins. (1), cyclooxygenase pathway; (2), lipoxygenase pathway; LT, leukotriene; LX, lipoxin; PG, prostaglandin; PGI,

prostacyclin; TX, thromboxane.) The subscript denotes the total number of double bonds in the molecule and the series to which the compound belongs.

THE CYCLOOXYGENASE PATHWAY IS RESPONSIBLE FOR PROSTANOID SYNTHESIS

Prostanoids (see [Chapter 21](#)) are synthesised by the pathway summarized in [Figure 23–12](#). In the first reaction, catalysed by **cyclooxygenase (COX)** (also called **prostaglandin H synthase**), an enzyme that has two activities, a **cyclooxygenase** and **peroxidase**, two molecules of O₂ are consumed.

COX is present as two isoenzymes, **COX-1** and **COX-2**. The product, an endoperoxide (PGH), is converted to prostaglandins D and E as well as to a thromboxane (TXA₂) and prostacyclin (PGI₂). Each cell type produces only one type of prostanoid.

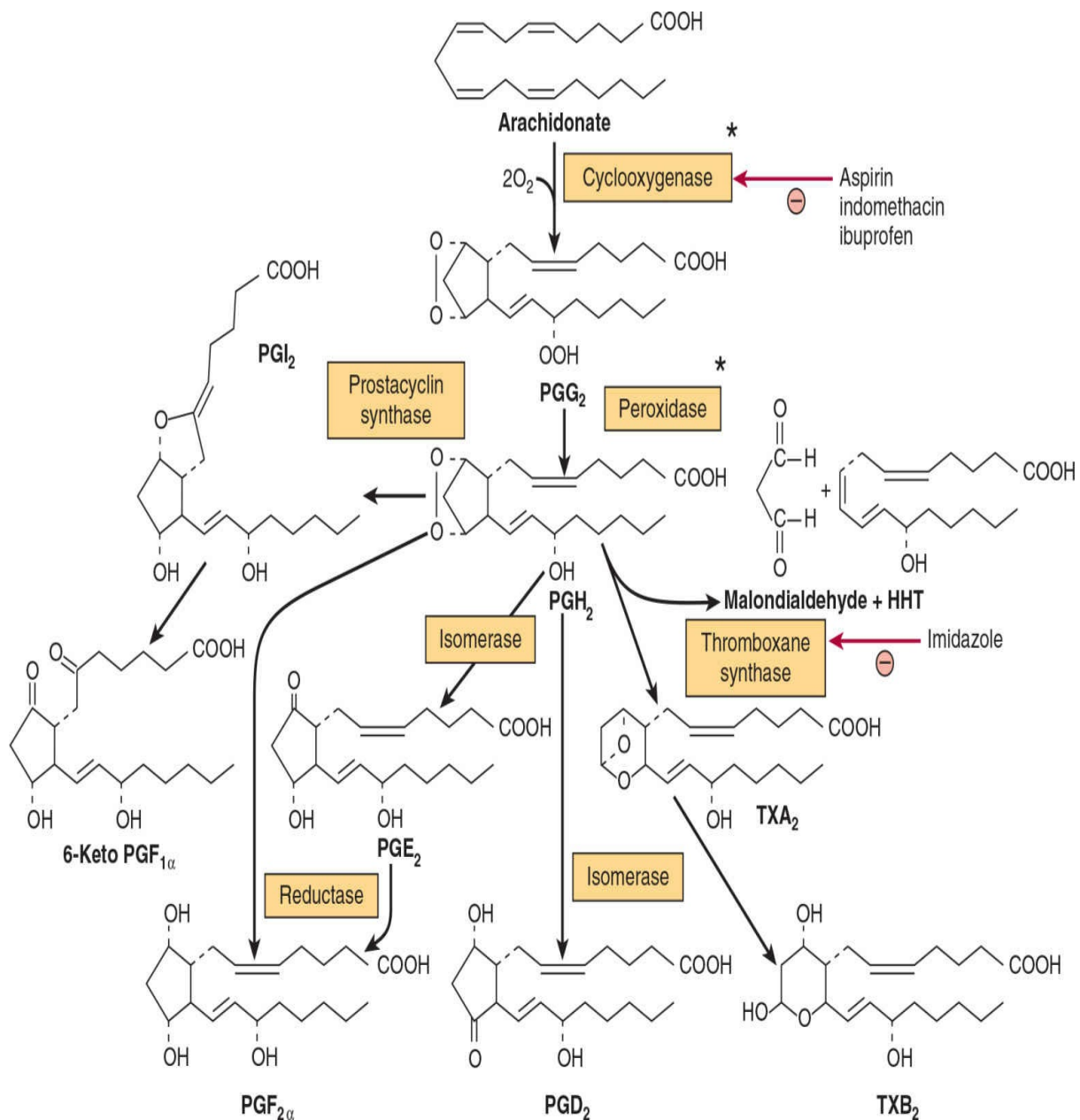

FIGURE 23–12 Conversion of arachidonic acid to prostaglandins and thromboxanes of series 2. (HHT, hydroxyheptadecatrienoate; PG, prostaglandin; PGI, prostacyclin; TX, thromboxane.) (*Both of these starred activities are attributed to the cyclooxygenase enzyme [prostaglandin H synthase]. Similar conversions occur in prostaglandins and thromboxanes of series 1 and 3.)

Prostanoids Are Potent, Biologically Active Substances

Thromboxanes are synthesized in platelets and upon release cause vasoconstriction and platelet aggregation. Their synthesis is specifically

inhibited by low-dose aspirin. **Prostacyclins (PGI₂)** are produced by blood vessel walls and are potent inhibitors of platelet aggregation.

Thus, thromboxanes and prostacyclins are antagonistic. PG₃ and TX₃, formed from eicosapentaenoic acid (EPA), inhibit the release of arachidonate from phospholipids and the formation of PG₂ and TX₂. PGI₃ is as potent an antiaggregator of platelets as PGI₂, but TXA₃ is a weaker aggregator than TXA₂, changing the balance of activity and favoring longer clotting times. As little as 1 ng/mL of plasma prostaglandins causes contraction of smooth muscle in animals.

Essential Fatty Acids Do Not Exert All Their Physiologic Effects via Prostaglandin Synthesis

The role of essential fatty acids in membrane formation is unrelated to prostaglandin formation. Prostaglandins do not relieve symptoms of essential fatty acid deficiency, and an essential fatty acid deficiency is not caused by inhibition of prostaglandin synthesis.

Cyclooxygenase Is a “Suicide Enzyme”

“Switching off” of prostaglandin activity is partly achieved by a remarkable property of cyclooxygenase—that of self-catalyzed destruction; that is, it is a “**suicide enzyme.**” Furthermore, the inactivation of prostaglandins by **15-hydroxyprostaglandin dehydrogenase** is rapid. Blocking the action of this enzyme with sulfasalazine or indomethacin can prolong the half-life of prostaglandins in the body.

LEUKOTRIENES & LIPOXINS ARE FORMED BY THE LIPOXYGENASE PATHWAY

The **leukotrienes** are a family of conjugated trienes formed from eicosanoic acids in leukocytes, mastocytoma cells, platelets, and macrophages by the **lipoxygenase pathway** in response to both immunologic and nonimmunologic stimuli. Three different lipoxygenases (dioxygenases) insert oxygen into the 5, 12, and 15 positions of arachidonic acid, giving rise to hydroperoxides (HPETE). Only **5-lipoxygenase** forms leukotrienes (details in [Figure 23–13](#)). **Lipoxins** are a family of conjugated tetraenes also arising in leukocytes. They are formed by the combined action of more than one lipoxygenase ([Figure 23–13](#)).

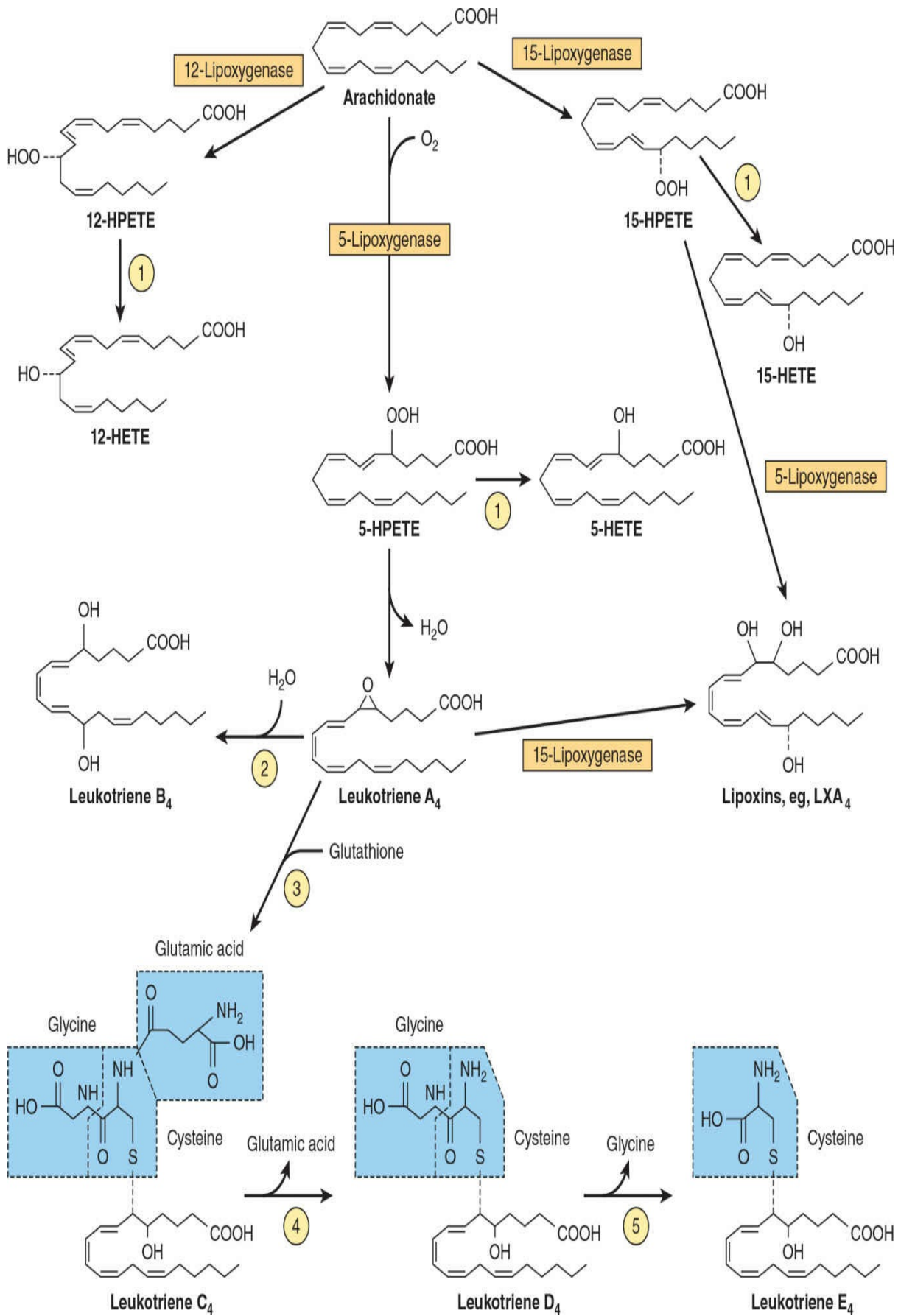

FIGURE 23–13 Conversion of arachidonic acid to leukotrienes and

lipoxins of series 4 via the lipoxygenase pathway. Some similar conversions occur in series 3 and 5 leukotrienes. (①, peroxidase; ②, leukotriene A₄ epoxide hydrolase; ③, glutathione S-transferase; ④, γ-glutamyltranspeptidase; ⑤, cysteinyl-glycine dipeptidase; HETE, hydroxyeicosatetraenoate; HPETE, hydroperoxyeicosatetraenoate.)

CLINICAL ASPECTS

Symptoms of Essential Fatty Acid Deficiency in Humans Include Skin Lesions & Impairment of Lipid Transport

In adults subsisting on ordinary diets, no signs of essential fatty acid deficiencies have been reported. However, infants receiving formula diets low in fat and patients maintained for long periods exclusively by intravenous nutrition low in essential fatty acids show deficiency symptoms that can be prevented by an essential fatty acid intake of 1 to 2% of the total caloric requirement.

Abnormal Metabolism of Essential Fatty Acids Occurs in Several Diseases

Abnormal metabolism of essential fatty acids, which may be connected with dietary insufficiency, has been noted in cystic fibrosis, acrodermatitis enteropathica, hepatorenal syndrome, Sjögren-Larsson syndrome, multisystem neuronal degeneration, Crohn disease, cirrhosis and alcoholism, and Reye syndrome. Elevated levels of very-long-chain polyenoic acids have been found in the brains of patients with Zellweger syndrome (see [Chapter 22](#)). Diets with a high P:S (polyunsaturated:saturated fatty acid) ratio reduce serum cholesterol levels and are considered to be beneficial in terms of the risk of development of coronary heart disease.

Trans Fatty Acids Are Implicated in Various Disorders

Small amounts of trans-unsaturated fatty acids are found in ruminant fat (eg, butter fat has 2-7%), where they arise from the action of microorganisms in the rumen, but the main source in the human diet is from partially hydrogenated vegetable oils (eg, margarine) (see [Chapter](#)

21). Trans fatty acids compete with essential fatty acids and may exacerbate essential fatty acid deficiency. Moreover, they are structurally similar to saturated fatty acids (see [Chapter 21](#)) and have comparable effects in the promotion of hypercholesterolemia and atherosclerosis (see [Chapter 26](#)).

Nonsteroidal Anti-Inflammatory Drugs Inhibit COX

Aspirin is a nonsteroidal anti-inflammatory drug (NSAID) that inhibits COX-1 and COX-2. Other NSAIDs include **indomethacin** and **ibuprofen**, and these usually inhibit cyclooxygenases by competing with arachidonate. Since inhibition of COX-1 causes the stomach irritation often associated with taking NSAIDs, attempts have been made to develop drugs that selectively inhibit COX-2 (**coxibs**). Unfortunately, however, the success of this approach has been limited and some coxibs have been withdrawn or suspended from the market due to undesirable side effects and safety issues. Transcription of COX-2—but not of COX-1—is completely inhibited by **anti-inflammatory corticosteroids**.

Prostanoids May Be Used Therapeutically

Potential therapeutic uses of prostanoids include prevention of conception, induction of labor at term, termination of pregnancy, prevention or alleviation of gastric ulcers, control of inflammation and of blood pressure, and relief of asthma and nasal congestion. In addition, PGD₂ is a potent sleep-promoting substance. Prostaglandins increase cAMP in platelets, thyroid, corpus luteum, fetal bone, adenohipophysis, and lung but reduce cAMP in renal tubule cells and adipose tissue (see [Chapter 25](#)).

Leukotrienes & Lipoxins Are Potent Regulators of Many Disease Processes

Slow-reacting substance of anaphylaxis (**SRS-A**) is a mixture of leukotrienes C₄, D₄, and E₄. This mixture of leukotrienes is a potent constrictor of the bronchial airway musculature. These leukotrienes together with **leukotriene B₄** also cause vascular permeability and attraction and activation of leukocytes and are important regulators in many diseases involving inflammatory or immediate hypersensitivity reactions, such as asthma. Leukotrienes are vasoactive, and 5-lipoxygenase has been found in arterial walls. Evidence supports an anti-inflammatory

role for lipoxins in vasoactive and immunoregulatory function, for example, as counterregulatory compounds (**chalone**s) of the immune response.

SUMMARY

- The synthesis of long-chain fatty acids (lipogenesis) is carried out by two enzyme systems: acetyl-CoA carboxylase and fatty acid synthase.
- The pathway converts acetyl-CoA to palmitate and requires NADPH, ATP, Mn^{2+} , biotin, and pantothenic acid as cofactors.
- Acetyl-CoA carboxylase converts acetyl-CoA to malonyl-CoA, and then fatty acid synthase, a multienzyme complex consisting of two identical polypeptide chains, each containing six separate enzymatic activities and ACP, catalyzes the formation of palmitate from one acetyl-CoA and seven malonyl-CoA molecules.
- Lipogenesis is regulated at the acetyl-CoA carboxylase step by allosteric modifiers, phosphorylation/dephosphorylation, and induction and repression of enzyme synthesis. The enzyme is allosterically activated by citrate and deactivated by long-chain acyl-CoA. Dephosphorylation (eg, by insulin) promotes its activity, while phosphorylation (eg, by glucagon or epinephrine) is inhibitory.
- Biosynthesis of unsaturated long-chain fatty acids is achieved by desaturase and elongase enzymes, which introduce double bonds and lengthen existing acyl chains, respectively.
- Higher animals have Δ^4 , Δ^5 , Δ^6 , and Δ^9 desaturases but cannot insert new double bonds beyond the position 9 of fatty acids. Thus, the essential fatty acids linoleic ($\omega 6$) and α -linolenic ($\omega 3$) must be obtained from the diet.
- Eicosanoids are derived from C_{20} (eicosanoic) fatty acids synthesized from the essential fatty acids and make up important groups of physiologically and pharmacologically active compounds, including the prostaglandins, thromboxanes, leukotrienes, and lipoxins.

REFERENCES

- Eljamil AS: *Lipid Biochemistry: For Medical Sciences*. iUniverse, 2015.
- Smith WL, Murphy RC: The eicosanoids: cyclooxygenase, lipoxygenase, and epoxygenase pathways. In *Biochemistry of Lipids, Lipoproteins and Membranes*, 6th ed. Ridgway N, McLeod R (editors). Academic

Press, 2015:260-296.

Metabolism of Acylglycerols & Sphingolipids

Kathleen M. Botham, PhD, DSc & Peter A. Mayes, PhD, DSc

OBJECTIVES

After studying this chapter, you should be able to:

- Explain that the catabolism of triacylglycerols involves hydrolysis to free fatty acids and glycerol and indicate the fate of these metabolites.
- Indicate that glycerol-3-phosphate is the substrate for the formation of both triacylglycerols and phosphoglycerols and that a branch point at phosphatidate leads to the synthesis of inositol phospholipids and cardiolipin or/and triacylglycerols and other phospholipids.
- Explain that plasmalogens and platelet-activating factor (PAF) are formed by a complex pathway starting from dihydroxyacetone phosphate.
- Illustrate the role of various phospholipases in the degradation and remodeling of phospholipids.
- Explain that ceramide is the precursor from which all sphingolipids are formed.

- Indicate how sphingomyelin and glycosphingolipids are produced by the reaction of ceramide with phosphatidylcholine or sugar residue(s), respectively.
- Identify examples of disease processes caused by defects in phospholipid or sphingolipid synthesis or breakdown.

BIOMEDICAL IMPORTANCE

Acylglycerols constitute the majority of lipids in the body.

Triacylglycerols are the major lipids in fat deposits and in food, and their roles in lipid transport and storage and in various diseases such as obesity, diabetes, and hyperlipoproteinemia will be described in subsequent chapters. The amphipathic nature of phospholipids and sphingolipids makes them ideally suitable as the main lipid component of cell membranes.

Phospholipids also take part in the metabolism of many other lipids. Some phospholipids have specialized functions; for example, dipalmitoyl lecithin is a major component of **lung surfactant**, which is lacking in **respiratory distress syndrome** of the newborn. Inositol phospholipids in the cell membrane act as precursors of **hormone second messengers**, and **platelet-activating factor (PAF)** is an alkylphospholipid. Glycosphingolipids, which contain sphingosine and sugar residues as well as a fatty acid are found in the outer leaflet of the plasma membrane with their oligosaccharide chains facing outward. They form part of the **glycocalyx** of the cell surface and are important (1) in cell adhesion and cell recognition, (2) as receptors for bacterial toxins (eg, the toxin that causes cholera), and (3) as ABO blood group substances. A dozen or so **glycolipid storage diseases** have been described (eg, Gaucher disease and Tay-Sachs disease), each due to a genetic defect in the pathway for glycolipid degradation in the lysosomes.

HYDROLYSIS INITIATES CATABOLISM OF TRIACYLGLYCEROLS

Triacylglycerols must be hydrolyzed by a **lipase** to their constituent fatty acids and glycerol before further catabolism can proceed. Much of this hydrolysis (lipolysis) occurs in adipose tissue with release of free fatty acids into the plasma, where they are found combined with serum albumin (see [Figure 25–7](#)). This is followed by free fatty acid uptake into tissues

(including liver, heart, kidney, muscle, lung, testis, and adipose tissue, but not readily by brain), where they are oxidized to obtain energy or reesterified. The utilization of glycerol depends on whether such tissues have the enzyme **glycerol kinase**, which is found in significant amounts in liver, kidney, intestine, brown adipose tissue, and the lactating mammary gland.

TRIACYLGLYCEROLS & PHOSPHOGLYCEROLS ARE FORMED BY ACYLATION OF TRIOSE PHOSPHATES

The major pathways of triacylglycerol and phosphoglycerol biosynthesis are outlined in **Figure 24–1**. Important substances such as triacylglycerols, phosphatidylcholine, phosphatidylethanolamine, phosphatidylinositol, and cardiolipin, a constituent of mitochondrial membranes, are formed from **glycerol-3-phosphate**. Significant branch points in the pathway occur at the **phosphatidate** and **diacylglycerol** steps. Phosphoglycerols containing an ether link (—C—O—C—), the best known of which are plasmalogens and PAF, are derived from **dihydroxyacetone phosphate**. Glycerol-3-phosphate and dihydroxyacetone phosphate are intermediates in glycolysis, making a very important connection between carbohydrate and lipid metabolism (see **Chapter 14**).

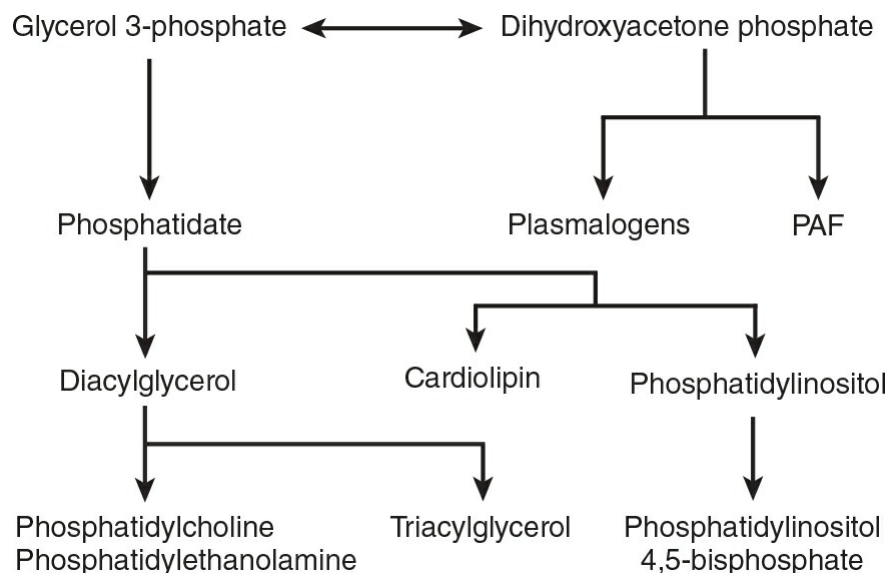

FIGURE 24–1 Overview of acylglycerol biosynthesis. (PAF, platelet-activating factor.)

Phosphatidate Is the Common Precursor in the Biosynthesis of Triacylglycerols, Many Phosphoglycerols, & Cardiolipin

Both glycerol and fatty acids must be activated by ATP before they can be incorporated into acylglycerols. **Glycerol kinase** catalyzes the activation of glycerol to *sn*-glycerol 3-phosphate. If the activity of this enzyme is absent or low, as in muscle or adipose tissue, most of the glycerol-3-phosphate is formed from dihydroxyacetone phosphate by **glycerol-3-phosphate dehydrogenase** (Figure 24-2).

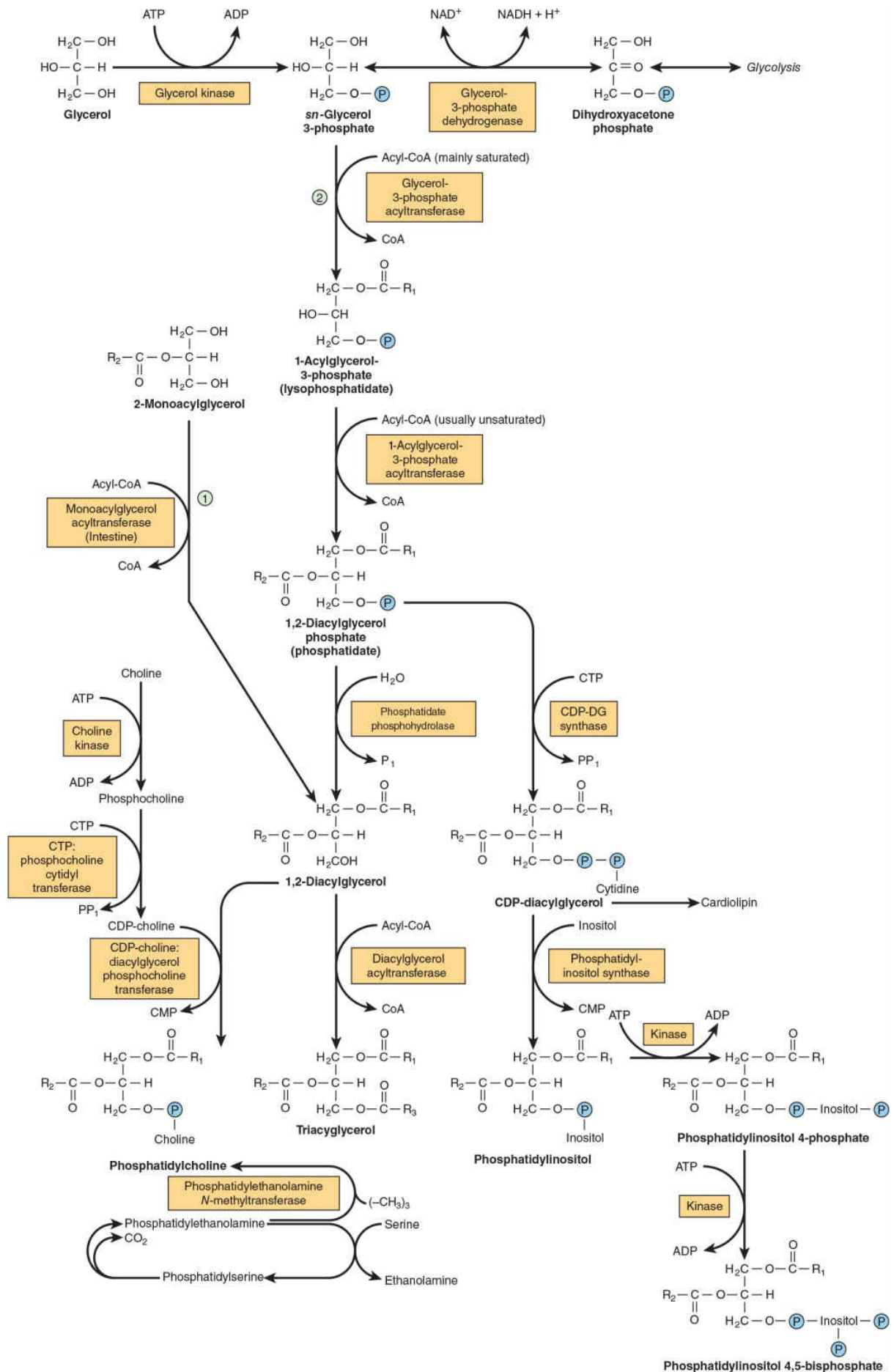

FIGURE 24–2 Biosynthesis of triacylglycerol and phospholipids. ①, monoacylglycerol pathway; ②, glycerol phosphate pathway. Phosphatidylethanolamine may be formed from ethanolamine by a pathway similar to that shown for the formation of phosphatidylcholine from choline.

Biosynthesis of Triacylglycerols

Two molecules of acyl-CoA, formed by the activation of fatty acids by **acyl-CoA synthetase** (see [Chapter 22](#)), combine with glycerol-3-phosphate to form **phosphatidate** (1,2-diacylglycerol phosphate). This takes place in two stages, catalyzed by **glycerol-3-phosphate acyltransferase** and **1-acylglycerol-3-phosphate acyltransferase**. Phosphatidate is converted by **phosphatidate phosphohydrolase** (also called **phosphatidate phosphatase [PAP]**) and **diacylglycerol acyltransferase (DGAT)** to 1,2-diacylglycerol and then triacylglycerol. **Lipins**, a family of three proteins, have PAP activity and they also act as transcription factors which regulate the expression of genes involved in lipid metabolism. DGAT catalyzes the only step specific for triacylglycerol synthesis and is thought to be rate limiting in most circumstances. In intestinal mucosa, **monoacylglycerol acyltransferase** converts **monoacylglycerol** to 1,2-diacylglycerol in the **monoacylglycerol pathway**. Most of the activity of these enzymes resides in the endoplasmic reticulum, but some is found in mitochondria. Although phosphatidate phosphohydrolase protein is found mainly in the cytosol, the active form of the enzyme is membrane bound.

Biosynthesis of Phospholipids

In the biosynthesis of **phosphatidylcholine** and **phosphatidylethanolamine** ([Figure 24–2](#)), choline or ethanolamine must first be activated by phosphorylation by ATP followed by linkage to CDP. The resulting CDP-choline or CDP-ethanolamine reacts with 1,2-diacylglycerol to form either phosphatidylcholine or phosphatidylethanolamine, respectively. **Phosphatidylserine** is formed from phosphatidylethanolamine directly by reaction with serine ([Figure 24–2](#)). Phosphatidylserine may reform phosphatidylethanolamine by decarboxylation. An alternative pathway in liver enables phosphatidylethanolamine to give rise directly to phosphatidylcholine by progressive methylation of the ethanolamine residue. In spite of these sources of choline, it is considered to be an essential nutrient in many

mammalian species, although this has not been established in humans.

The regulation of triacylglycerol, phosphatidylcholine, and phosphatidylethanolamine biosynthesis is driven by the availability of free fatty acids. Those that escape oxidation are preferentially converted to phospholipids, and when this requirement is satisfied, they are used for triacylglycerol synthesis.

Cardiolipin (diphosphatidylglycerol; see [Figure 21–9](#)) is a phospholipid present in mitochondria. It is formed from phosphatidylglycerol, which in turn is synthesized from CDP-diacylglycerol ([Figure 24–2](#)) and glycerol-3-phosphate. Cardiolipin, found in the inner membrane of mitochondria, has a key role in mitochondrial structure and function, and is also thought to be involved in programmed cell death (**apoptosis**).

Biosynthesis of Glycerol Ether Phospholipids

In **glycerol ether phospholipids**, one or more of the glycerol carbons is attached to a hydrocarbon chain by an ether linkage rather than an ester bond. **Plasmalogens and PAF** are important examples of this type of lipid. The biosynthetic pathway is located in peroxisomes.

Dihydroxyacetone phosphate is the precursor of the glycerol moiety ([Figure 24–3](#)). It combines with acyl-CoA to give 1-acyldihydroxyacetone phosphate, and the ether link is formed in the next reaction, producing 1-alkyldihydroxyacetone phosphate, which is then converted to 1-alkylglycerol 3-phosphate. After further acylation in the 2 position, the resulting 1-alkyl-2-acylglycerol 3-phosphate (analogous to phosphatidate in [Figure 24–2](#)) is hydrolyzed to give the free glycerol derivative.

Plasmalogens, which comprise much of the phospholipid in mitochondria, are formed by desaturation of the analogous 3-phosphoethanolamine derivative ([Figure 24–3](#)). PAF (1-alkyl-2-acetyl-*sn*-glycerol-3-phosphocholine) is synthesized from the corresponding 3-phosphocholine derivative. It is formed by many blood cells and other tissues and aggregates platelets at concentrations as low as 10^{-11} mol/L. It also has hypotensive and ulcerogenic properties and is involved in a variety of biologic responses, including inflammation, chemotaxis, and protein phosphorylation.

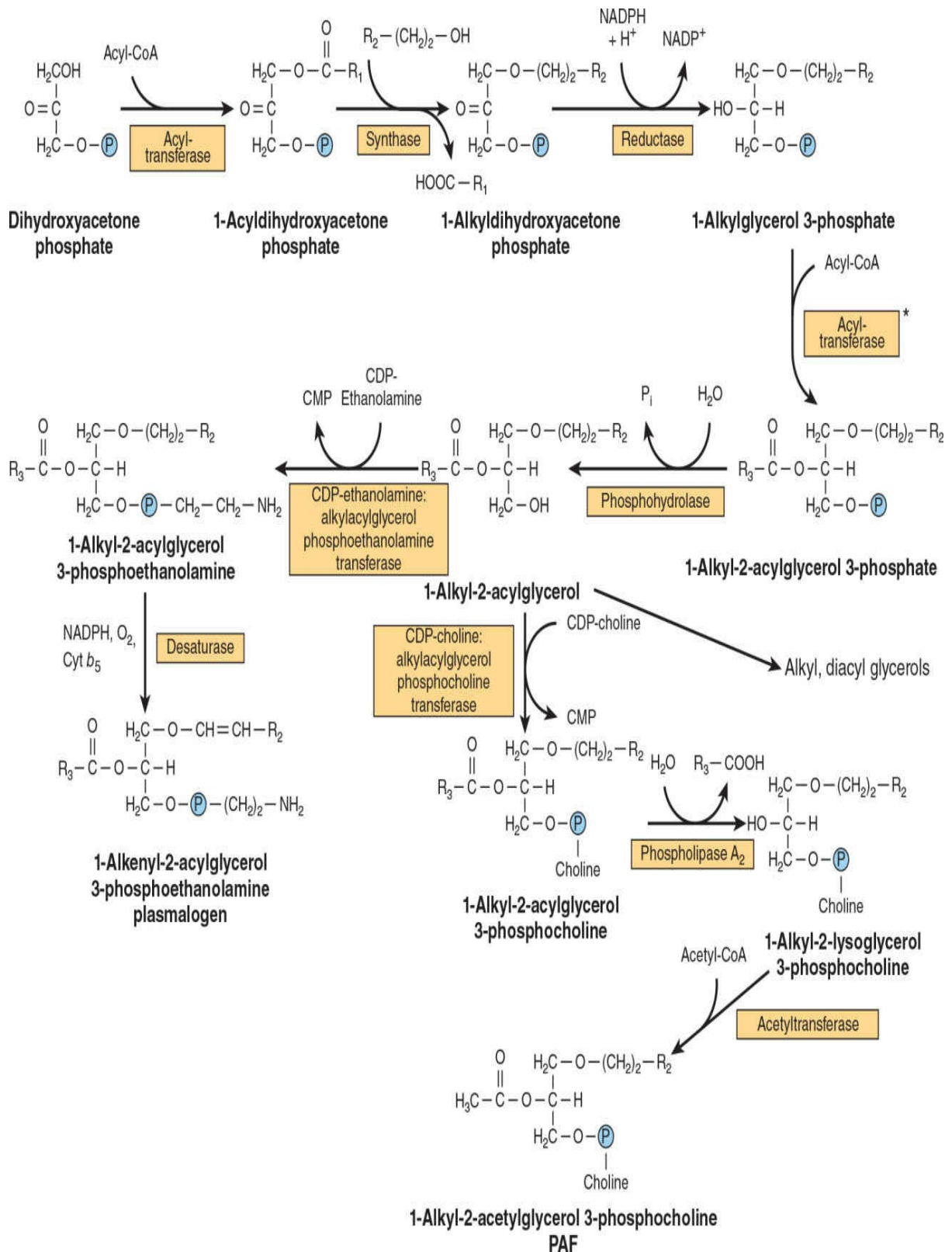

FIGURE 24-3 Biosynthesis of ether lipids, including plasmalogens, and platelet-activating factor (PAF). In the de novo pathway for PAF synthesis, acetyl-CoA is incorporated at stage*, avoiding the last two steps in the pathway shown here.

Phospholipases Allow Degradation & Remodeling of Phosphoglycerols

Although phospholipids are actively degraded, each portion of the molecule turns over at a different rate—for example, the turnover time of the phosphate group is different from that of the 1-acyl group. This is due to the presence of enzymes that allow partial degradation followed by resynthesis (**Figure 24–4**). **Phospholipase A₂** catalyzes the hydrolysis of glycerophospholipids to form a free fatty acid and lysophospholipid, which in turn may be reacylated by acyl-CoA in the presence of an acyltransferase. Alternatively, lysophospholipid (eg, lysolecithin) is attacked by **lysophospholipase**, forming the corresponding glyceryl phosphoryl base, which may then be split by a hydrolase liberating glycerol-3-phosphate plus base. **Phospholipases A₁, A₂, B, C, and D** attack the bonds indicated in **Figure 24–5**. **Phospholipase A₂** is found in pancreatic fluid and snake venom as well as in many types of cells; **phospholipase C** is one of the major toxins secreted by bacteria; and **phospholipase D** is known to be involved in mammalian signal transduction.

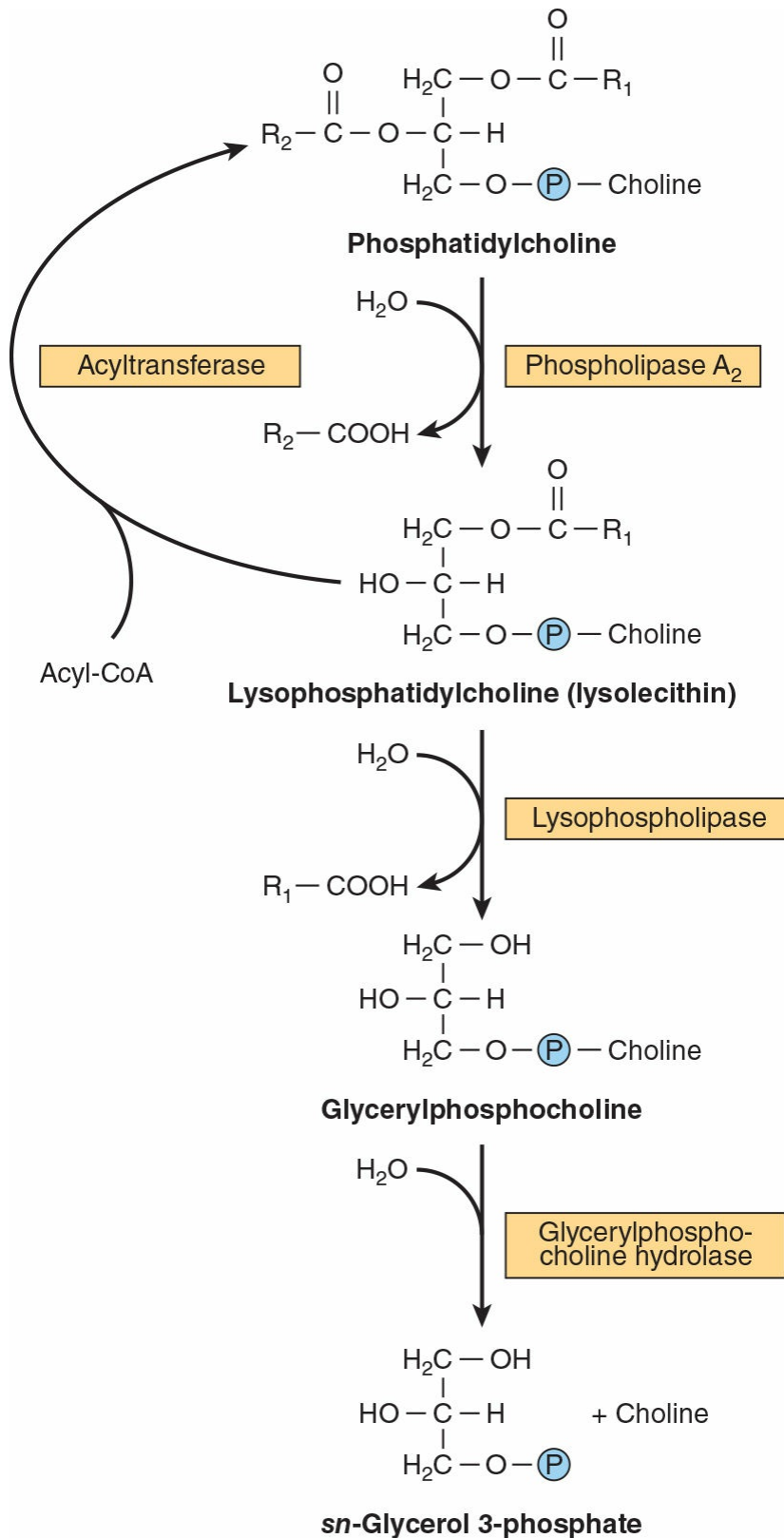

FIGURE 24-4 Metabolism of phosphatidylcholine (lecithin).

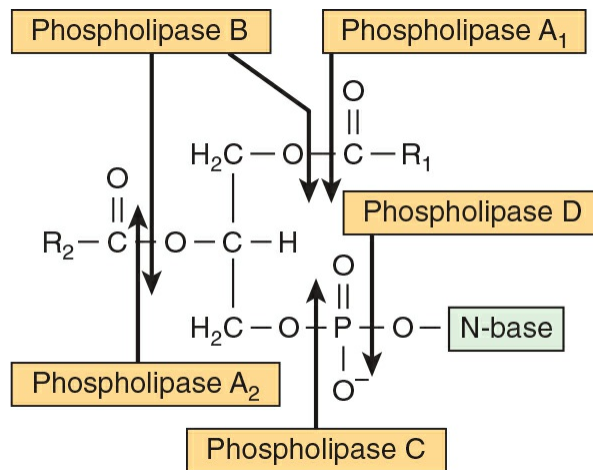

FIGURE 24–5 Sites of the hydrolytic activity of phospholipases on a phospholipid substrate.

Lysolecithin (lysophosphatidylcholine) may be formed by an alternative route that involves **lecithin: cholesterol acyltransferase (LCAT)**. This enzyme, found in plasma, catalyzes the transfer of a fatty acid residue from the 2 position of lecithin to cholesterol to form cholesteryl ester and lysolecithin, and is considered to be responsible for much of the cholesteryl ester in plasma lipoproteins (see [Chapter 25](#)).

Long-chain saturated fatty acids are found predominantly in the 1 position of phospholipids, whereas the polyunsaturated fatty acids (eg, the precursors of prostaglandins) are incorporated more frequently into the 2 position. The incorporation of fatty acids into lecithin occurs in three ways; by complete synthesis of the phospholipid; by transacylation between cholesteryl ester and lysolecithin; and by direct acylation of lysolecithin by acyl-CoA. Thus, a continuous exchange of the fatty acids is possible, particularly with regard to introducing essential fatty acids into phospholipid molecules.

ALL SPHINGOLIPIDS ARE FORMED FROM CERAMIDE

Ceramide (see [Chapter 21](#)) is synthesized in the endoplasmic reticulum from the amino acid serine as shown in [Figure 24–6](#). Ceramide is an important signaling molecule (second messenger) regulating pathways including programmed cell death (**apoptosis**), the **cell cycle**, and **cell differentiation** and **senescence**.

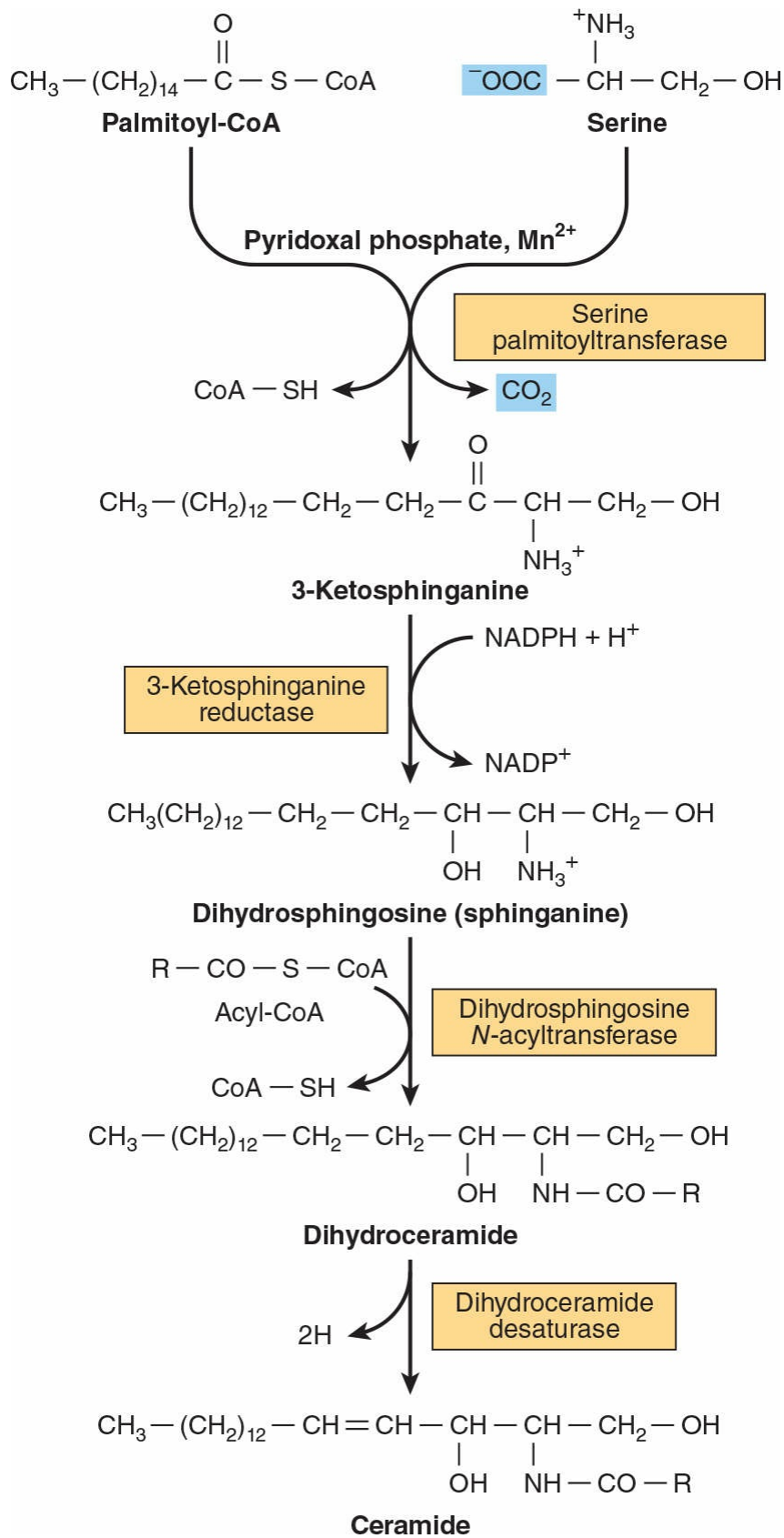

FIGURE 24–6 Biosynthesis of ceramide.

Sphingomyelins (see [Figure 21–10](#)) are phospholipids and are formed

when ceramide reacts with phosphatidylcholine to form sphingomyelin plus diacylglycerol (**Figure 24–7A**). This occurs mainly in the Golgi apparatus and to a lesser extent in the plasma membrane.

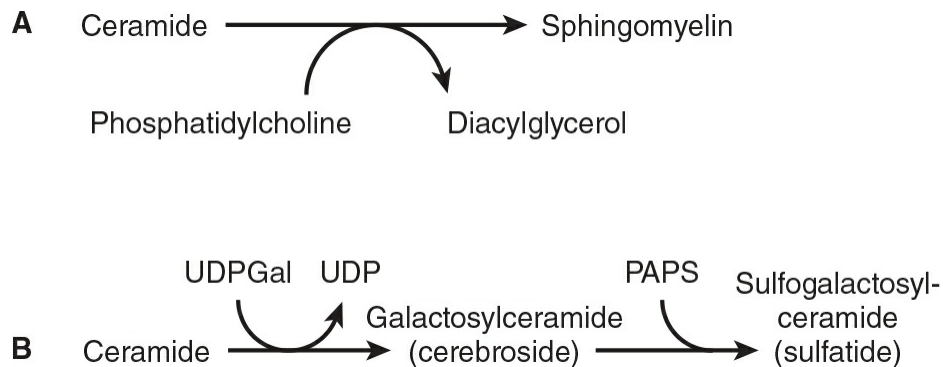

FIGURE 24–7 Biosynthesis of (A) sphingomyelin, (B) galactosylceramide and its sulfo derivative. (PAPS, “active sulfate,” adenosine 3′-phosphate-5′-phosphosulfate.)

Glycosphingolipids Are a Combination of Ceramide With One or More Sugar Residues

The simplest glycosphingolipids (**cerebrosides**) are **galactosylceramide (GalCer)** (see **Figure 21–14**) and **glucosylceramide (GlcCer)**. GalCer is a major lipid of **myelin**, whereas GlcCer is the major glycosphingolipid of **extraneural tissues** and a precursor of most of the more complex glycosphingolipids. GalCer (**Figure 24–7B**) is formed in a reaction between ceramide and uridine diphosphate galactose (UDPGal) (formed by epimerization from UDPGlc—**Figure 20–6**).

Sulfogalactosylceramide and other sulfolipids such as the **sulfo(galacto)-glycerolipids** and the **steroid sulfates** are formed after further reactions involving 3′-phosphoadenosine-5′-phosphosulfate (PAPS; “active sulfate”). **Gangliosides** are synthesized from ceramide by the stepwise addition of activated sugars (eg, UDPGlc and UDPGal) and a **sialic acid**, usually *N*-acetylneuraminic acid (**Figure 24–8**). A large number of gangliosides of increasing molecular weight may be formed. Most of the enzymes transferring sugars from nucleotide sugars (glycosyl transferases) are found in the Golgi apparatus.

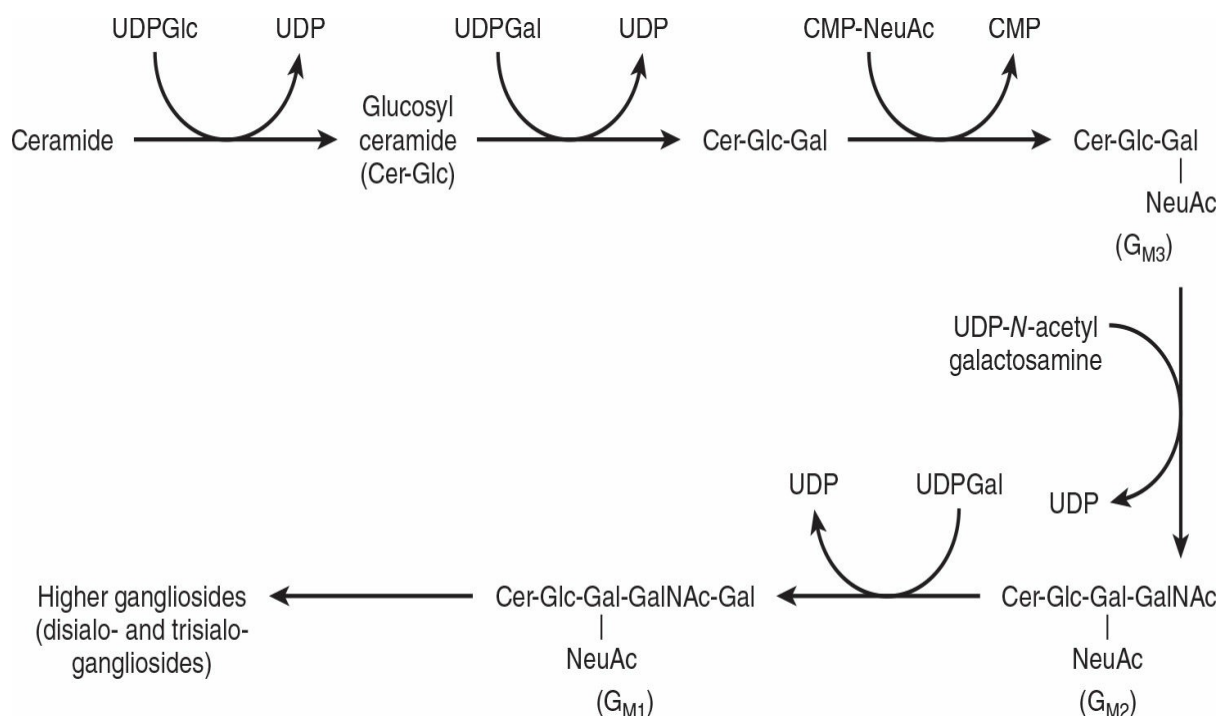

FIGURE 24–8 Biosynthesis of gangliosides. (NeuAc, *N*-acetylneuraminic acid.)

Glycosphingolipids are constituents of the outer leaflet of plasma membranes and are important in **cell adhesion** and **cell recognition**. Some are antigens, for example, ABO blood group substances. Certain gangliosides function as receptors for bacterial toxins (eg, for **cholera toxin**, which subsequently activates adenylyl cyclase).

CLINICAL ASPECTS

Deficiency of Lung Surfactant Causes Respiratory Distress Syndrome

Lung surfactant is composed mainly of lipid with some proteins and carbohydrate and prevents the alveoli from collapsing. The phospholipid **dipalmitoyl-phosphatidylcholine** decreases surface tension at the air-liquid interface and thus greatly reduces the work of breathing, but other surfactant lipid and protein components are also important in surfactant function. Deficiency of lung surfactant in the lungs of many preterm newborns gives rise to **infant respiratory distress syndrome (IRDS)**. Administration of either natural or artificial surfactant is of therapeutic benefit.

Phospholipids & Sphingolipids Are Involved in Multiple Sclerosis and Lipidoses

Certain diseases are characterized by abnormal quantities of these lipids in the tissues, often in the nervous system. They may be classified into two groups: (1) true demyelinating diseases and (2) sphingolipidoses.

In **multiple sclerosis**, which is a demyelinating disease, there is loss of both phospholipids (particularly ethanolamine plasmalogen) and of sphingolipids from white matter. Thus, the lipid composition of white matter resembles that of gray matter. The cerebrospinal fluid shows raised phospholipid levels.

The **sphingolipidoses (lipid storage diseases)** are a group of inherited diseases that are caused by a genetic defect in the catabolism of lipids containing sphingosine. They are part of a larger group of lysosomal disorders and exhibit several constant features: (1) complex lipids containing ceramide accumulate in cells, particularly neurons, causing neurodegeneration and shortening the life span. (2) The rate of **synthesis** of the stored lipid is normal. (3) The enzymatic defect is in the **lysosomal degradation pathway** of sphingolipids. (4) The extent to which the activity of the affected enzyme is decreased is similar in all tissues. There is no effective treatment for many of the diseases, although some success has been achieved with **enzyme replacement therapy** and **bone marrow transplantation** in the treatment of Gaucher and Fabry diseases. Other promising approaches are **substrate deprivation therapy** to inhibit the synthesis of sphingolipids and **chemical chaperone therapy**. **Gene therapy** for lysosomal disorders is also currently under investigation. Some examples of the more important lipid storage diseases are shown in **Table 24–1**.

TABLE 24–1 Examples of Sphingolipidoses

Disease	Enzyme Deficiency	Lipid Accumulating	Clinical Symptoms
Tay-Sachs disease	Hexosaminidase A	Cer—Glc—Gal(NeuAc)— \ddagger GalNAc G _{M2} Ganglioside	Mental retardation, blindness, muscular weakness
Fabry disease	α -Galactosidase	Cer—Glc—Gal— \ddagger Gal Globotriaosylceramide	Skin rash, kidney failure (full symptoms only in males; X-linked recessive)
Metachromatic leukodystrophy	Arylsulfatase A	Cer—Gal— \ddagger OSO ₃ 3-Sulfogalactosylceramide	Mental retardation and psychologic disturbances in adults; demyelination
Krabbe disease	β -Galactosidase	Cer— \ddagger Gal Galactosylceramide	Mental retardation; myelin almost absent
Gaucher disease	β -Glucosidase	Cer— \ddagger Glc Glucosylceramide	Enlarged liver and spleen, erosion of long bones, mental retardation in infants
Niemann-Pick disease	Sphingomyelinase	Cer— \ddagger P—choline Sphingomyelin	Enlarged liver and spleen, mental retardation; fatal in early life
Farber disease	Ceramidase	Acyl— \ddagger Sphingosine Ceramide	Hoarseness, dermatitis, skeletal deformation, mental retardation; fatal in early life

Abbreviations: Cer, ceramide; Gal, galactose; Glc, glucose; NeuAc, *N*-acetylneuraminic acid; \ddagger , site of deficient enzyme reaction.

Multiple sulfatase deficiency results in accumulation of sulfogalactosylceramide, steroid sulfates, and proteoglycans owing to a combined deficiency of arylsulfatases A, B, and C and steroid sulfatase.

SUMMARY

- Triacylglycerols are the major energy-storing lipids, whereas phosphoglycerols, sphingomyelin, and glycosphingolipids are amphipathic and have structural functions in cell membranes as well as other specialized roles.
- Triacylglycerols and some phosphoglycerols are synthesized by progressive acylation of glycerol-3-phosphate. The pathway bifurcates at phosphatidate, forming inositol phospholipids and cardiolipin on the one hand and triacylglycerol and choline and ethanolamine phospholipids on the other.
- Plasmalogens and PAF are ether phospholipids formed from dihydroxyacetone phosphate.
- Sphingolipids are formed from ceramide (*N*-acylsphingosine). Sphingomyelin is present in membranes of organelles involved in secretory processes (eg, Golgi apparatus). The simplest

glycosphingolipids are a combination of ceramide plus a sugar residue (eg, GalCer in myelin). Gangliosides are more complex glycosphingolipids containing more sugar residues plus sialic acid. They are present in the outer layer of the plasma membrane, where they contribute to the glycocalyx and are important as antigens and cell receptors.

- Phospholipids and sphingolipids are involved in several disease processes, including infant respiratory distress syndrome (lack of lung surfactant), multiple sclerosis (demyelination), and sphingolipidoses (inability to break down sphingolipids in lysosomes due to inherited defects in hydrolase enzymes).

REFERENCES

- Eljamil AS: *Lipid Biochemistry: For Medical Sciences*. iUniverse, 2015.
- Futerman AH: Sphingolipids. In *Biochemistry of Lipids, Lipoproteins and Membranes*, 6th ed. Ridgway N, McLeod R (editors). Academic Press, 2015:297-327.
- Ridgway ND: Phospholipid synthesis in mammalian cells. In *Biochemistry of Lipids, Lipoproteins and Membranes*, 6th ed. Academic Press, 2015:210-236.

Lipid Transport & Storage

Kathleen M. Botham, PhD, DSc & Peter A. Mayes, PhD, DSc

OBJECTIVES

After studying this chapter, you should be able to:

- Identify the four major groups of plasma lipoproteins and the four major lipid classes they carry.
- Illustrate the structure of a lipoprotein particle.
- Indicate the major types of apolipoprotein found in the different lipoprotein classes.
- Explain that triacylglycerol from the diet is carried to the liver in chylomicrons and from the liver to extrahepatic tissues in very-low-density lipoprotein (VLDL), and that these particles are synthesized in intestinal and liver cells, respectively, by similar processes.
- Illustrate the processes by which chylomicrons are metabolized by lipases to form chylomicron remnants, which are then removed from the circulation by the liver.
- Explain how VLDL is metabolized by lipases to intermediate-density lipoprotein (IDL) which may be cleared by the liver or converted to low-density lipoprotein (LDL), which functions to deliver cholesterol from the liver to extrahepatic tissues via the

LDL (apoB100, E) receptor.

- Explain how high-density lipoprotein (HDL) is synthesized, indicate the mechanisms by which it accepts cholesterol from extrahepatic tissues and returns it to the liver in reverse cholesterol transport.
- Describe how the liver plays a central role in lipid transport and metabolism and how hepatic VLDL secretion is regulated by the diet and hormones.
- Indicate the roles of LDL and HDL in promoting and retarding, respectively, the development of atherosclerosis.
- Indicate the causes of alcoholic and nonalcoholic fatty liver disease (NAFLD).
- Explain the processes by which fatty acids are released from triacylglycerol stored in adipose tissue.
- Understand the role of brown adipose tissue in the generation of body heat.

BIOMEDICAL IMPORTANCE

Fat absorbed from the diet and lipids synthesized by the liver and adipose tissue must be transported between the various tissues and organs for utilization and storage. Since lipids are insoluble in water, the problem of how to transport them in the aqueous blood plasma is solved by associating nonpolar lipids (triacylglycerol and cholesteryl esters) with amphipathic lipids (phospholipids and cholesterol) and proteins to make **water-miscible lipoproteins**.

In a meal-eating omnivore such as the human, excess calories are ingested in the anabolic phase of the feeding cycle, followed by a period of negative caloric balance when the organism draws on its carbohydrate and fat stores. Lipoproteins mediate this cycle by transporting lipids from the intestines as **chylomicrons**—and from the liver as **very-low-density lipoproteins (VLDL)**—to most tissues for oxidation and to adipose tissue for storage. Lipid is mobilized from adipose tissue as free fatty acids (FFAs) bound to serum albumin. Abnormalities of lipoprotein metabolism cause various **hypo-** or **hyperlipoproteinemias**. The most common of these is in **diabetes mellitus**, where insulin deficiency causes excessive mobilization of FFA and underutilization of chylomicrons and VLDL, leading to **hypertriacylglycerolemia**. Most other pathologic conditions affecting lipid transport are due primarily to inherited defects, some of

which cause **hypercholesterolemia** and premature **atherosclerosis** (see [Table 26–1](#)). **Obesity**—particularly abdominal obesity—is a risk factor for increased mortality, hypertension, type 2 diabetes mellitus, hyperlipidemia, hyperglycemia, and various endocrine dysfunctions.

LIPIDS ARE TRANSPORTED IN THE PLASMA AS LIPOPROTEINS

Four Major Lipid Classes Are Present in Lipoproteins

Plasma lipids consist of **triacylglycerols** (16%), **phospholipids** (30%), **cholesterol** (14%), and **cholesteryl esters** (36%) and a much smaller fraction of unesterified long-chain fatty acids (or FFAs) (4%). This latter fraction, the **FFA**, is metabolically the most active of the plasma lipids.

Four Major Groups of Plasma Lipoproteins Have Been Identified

Since fat is less dense than water, the density of a lipoprotein decreases as the proportion of lipid to protein increases ([Table 25–1](#)). Four major groups of lipoproteins have been identified that are important physiologically and in clinical diagnosis. These are (1) **chylomicrons**, derived from intestinal absorption of triacylglycerol and other lipids; (2) **VLDL**, derived from the liver for the export of triacylglycerol; (3) **low-density lipoproteins** (LDL), representing a final stage in the catabolism of VLDL; and (4) **high-density lipoproteins**, (HDL), involved in cholesterol transport and also in VLDL and chylomicron metabolism. Triacylglycerol is the predominant lipid in chylomicrons and VLDL, whereas cholesterol and phospholipid are the predominant lipids in LDL and HDL, respectively ([Table 25–1](#)). Lipoproteins may also be classified according to their electrophoretic properties into **α** - (HDL), **β** - (LDL), and **pre- β** (VLDL)-lipoproteins.

TABLE 25–1 Composition of the Lipoproteins in Plasma of Humans

Lipoprotein	Source	Diameter (nm)	Density (g/mL)	Composition		Main Lipid Components	Apolipoproteins
				Protein (%)	Lipid (%)		
Chylomicrons	Intestine	90-1000	<0.95	1-2	98-99	Triacylglycerol	A-I, A-II, A-IV, ^a B-48, C-I, C-II, C-III, E
Chylomicron remnants	Chylomicrons	45-150	<1.006	6-8	92-94	Triacylglycerol, phospholipids, cholesterol	B-48, E
VLDL	Liver (intestine)	30-90	0.95-1.006	7-10	90-93	Triacylglycerol	B-100, C-I, C-II, C-III
IDL	VLDL	25-35	1.006-1.019	11	89	Triacylglycerol, cholesterol	B-100, E
LDL	VLDL	20-25	1.019-1.063	21	79	Cholesterol	B-100
HDL	Liver, intestine, VLDL, chylomicrons					Phospholipids, cholesterol	A-I, A-II, A-IV, C-I, C-II, C-III, D, ^b E
HDL ₁		20-25	1.019-1.063	32	68		
HDL ₂		10-20	1.063-1.125	33	67		
HDL ₃		5-10	1.125-1.210	57	43		
Pre β -HDL ^c		<5	>1.210				A-I
Albumin/free fatty acids	Adipose tissue		>1.281	99	1	Free fatty acids	

^aSecreted with chylomicrons but transfers to HDL.

^bAssociated with HDL₂ and HDL₃ subfractions.

^cPart of a minor fraction known as very-high-density lipoproteins (VHDL).

Abbreviations: HDL, high-density lipoproteins; IDL, intermediate-density lipoproteins; LDL, low-density lipoproteins; VLDL, very-low-density lipoproteins.

Lipoproteins Consist of a Nonpolar Core & a Single Surface Layer of Amphipathic Lipids

The **nonpolar lipid core** consists of mainly **triacylglycerol** and **cholesteryl ester** and is surrounded by a **single surface layer** of **amphipathic phospholipid** and **cholesterol** molecules (**Figure 25–1**). These are oriented so that their polar groups face outward to the aqueous medium, as in the cell membrane (see **Chapters 21** and **40**). The protein moiety of a lipoprotein is known as an **apolipoprotein** or **apoprotein**, constituting nearly 70% of some HDL and as little as 1% of chylomicrons.

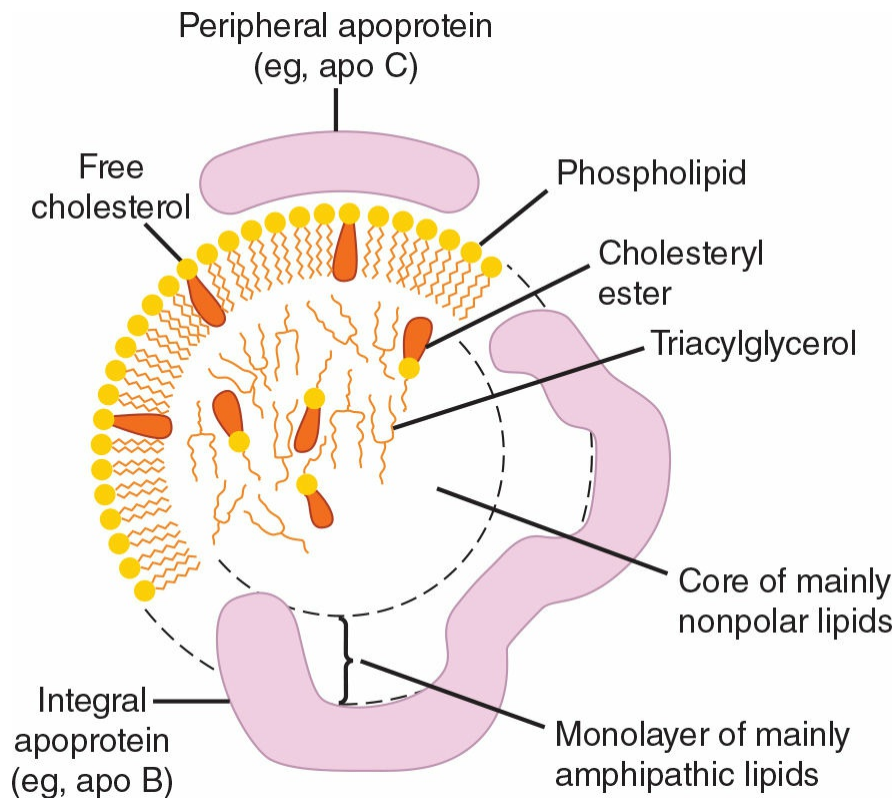

FIGURE 25–1 Generalized structure of a plasma lipoprotein. Small amounts of cholesteryl ester and triacylglycerol are found in the surface layer and a little free cholesterol in the core.

The Distribution of Apolipoproteins Characterizes the Lipoprotein

One or more apolipoproteins are present in each lipoprotein. They are usually abbreviated as apo followed by the letter A, B, C, etc (Table 25–1). Some apolipoproteins are integral and cannot be removed (eg, apo B), whereas others are bound to the surface and are free to transfer to other lipoproteins, eg, apos C and E). The major apolipoproteins of HDL (α -lipoprotein) are apo As (Table 25–1). The main apolipoprotein of LDL (β -lipoprotein) is apo B (B-100), which is found also in VLDL. Chylomicrons contain a truncated form (48% of apo B-100) of apo B (B-48) that is synthesized in the intestine, while B-100 is synthesized in the liver. Apo B-100 is one of the longest single polypeptide chains known, having 4536 amino acids and a molecular mass of 550,000 Da. To produce Apo B-48, a stop signal is introduced into the mRNA transcript for apo B-100 by an RNA editing enzyme. Apos C-I, C-II, and C-III are smaller polypeptides (molecular mass 7000-9000 Da) freely transferable between several different lipoproteins. Apo E, found in VLDL, HDL, chylomicrons, and

chylomicron remnants, is also freely transferable; it accounts for 5 to 10% of total VLDL apolipoproteins in normal subjects.

Apolipoproteins carry out several roles: (1) they can form part of the structure of the lipoprotein, for example, apo B; (2) they are enzyme cofactors, for example, C-II for lipoprotein lipase, A-I for lecithin:cholesterol acyltransferase (LCAT), or enzyme inhibitors, for example, apo A-II and apo C-III for lipoprotein lipase, apo C-I for cholesteryl ester transfer protein; and (3) they act as ligands for interaction with lipoprotein receptors in tissues, for example, apo B-100 and apo E for the LDL receptor, apo E for the LDL-receptor-related protein-1 (LRP-1), which recognizes remnant lipoproteins (see below), and apo A-I for the HDL receptor. Apo A-IV is thought to have a role in chylomicron metabolism and may also act as a regulator of satiety and glucose homeostasis, making it a potential therapeutic target for the treatment of diabetes and obesity, while apo D is believed to be an important factor in human neurodegenerative disorders.

FREE FATTY ACIDS ARE RAPIDLY METABOLIZED

The FFAs (also termed nonesterified fatty acids [NEFAs] or unesterified fatty acids) arise in the plasma from the breakdown of triacylglycerol in adipose tissue or as a result of the action of lipoprotein lipase on the plasma triacylglycerols. They are found **in combination with albumin**, a very effective solubilizer. Levels are low in the fully fed condition and rise to 0.7 to 0.8 mEq/mL in the starved state. In uncontrolled **diabetes mellitus**, the level may rise to as much as 2 mEq/mL.

FFAs are removed from the blood extremely rapidly by the tissues and oxidized (fulfilling 25-50% of energy requirements in starvation) or esterified to form triacylglycerol. In starvation, esterified lipids from the circulation or in the tissues are also oxidized, particularly in heart and skeletal muscle cells, where considerable stores of lipid are found.

The FFA uptake by tissues is related directly to the plasma-FFA concentration, which in turn is determined by the rate of lipolysis in adipose tissue. After dissociation of the fatty acid–albumin complex at the plasma membrane, fatty acids bind to a **membrane fatty acid transport protein** that acts as a transmembrane cotransporter with Na^+ . On entering the cytosol, FFAs are bound by intracellular **fatty acid-binding proteins**. The role of these proteins in intracellular transport is thought to be similar

to that of serum albumin in extracellular transport of long-chain fatty acids.

TRIACYLGLYCEROL IS TRANSPORTED FROM THE INTESTINES IN CHYLOMICRONS & FROM THE LIVER IN VERY-LOW-DENSITY LIPOPROTEINS

By definition, **chylomicrons** are found in **chyle** formed only by the lymphatic system **draining the intestine**. They are responsible for the transport of all dietary lipids into the circulation. Small quantities of VLDL are also to be found in chyle; however, most **VLDL in the plasma** are of hepatic origin. **They are the vehicles of transport of triacylglycerol from the liver to the extrahepatic tissues.**

There are striking similarities in the mechanisms of formation of chylomicrons by intestinal cells and of VLDL by hepatic parenchymal cells (**Figure 25–2**), perhaps because—apart from the mammary gland—the intestine and liver are the only tissues from which particulate lipid is secreted. Newly secreted or “nascent” chylomicrons and VLDL contain only a small amount of apolipoproteins C and E, and the full complement is acquired from HDL in the circulation (**Figures 25–3** and **25–4**). Apo B, however, is an integral part of the lipoprotein particles. It is incorporated into the particles during their assembly inside the cells and is essential for chylomicron and VLDL formation. In **abetalipoproteinemia** (a rare disease), lipoproteins containing apo B are not formed and lipid droplets accumulate in the intestine and liver.

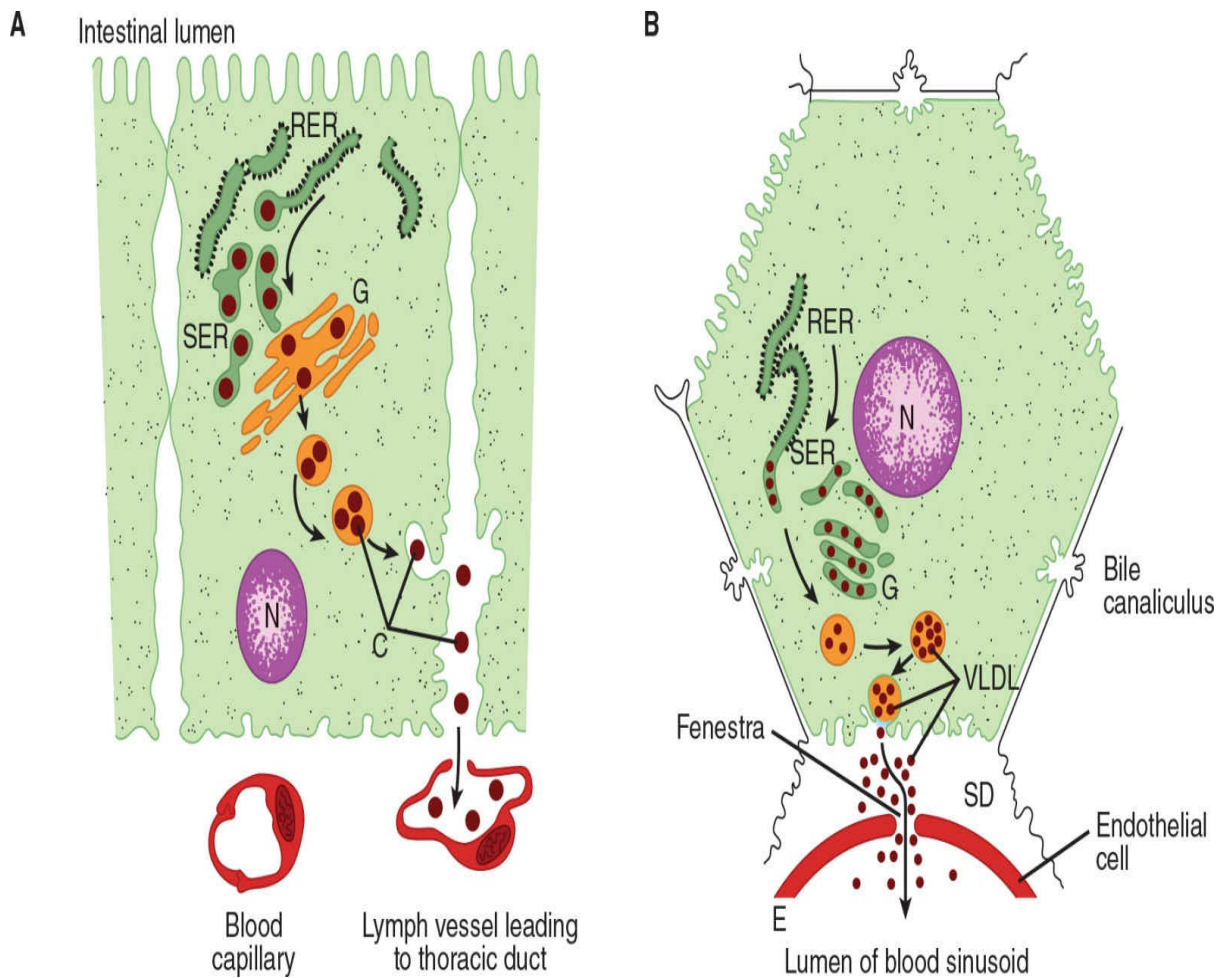

FIGURE 25–2 The formation and secretion of (A) chylomicrons by an intestinal cell and (B) very-low-density lipoproteins by a hepatic cell. (C, chylomicrons; E, endothelium; G, Golgi apparatus; N, nucleus; RER, rough endoplasmic reticulum; SD, space of Disse, containing blood plasma; SER, smooth endoplasmic reticulum; VLDL, very-low-density lipoprotein.) Apolipoprotein B, synthesized in the RER, is incorporated into particles with triacylglycerol, cholesterol, and phospholipids in the SER. After the addition of carbohydrate residues in G, they are released from the cell by reverse pinocytosis. Chylomicrons pass into the lymphatic system. VLDL are secreted into the space of Disse and then into the hepatic sinusoids through fenestrae in the endothelial lining.

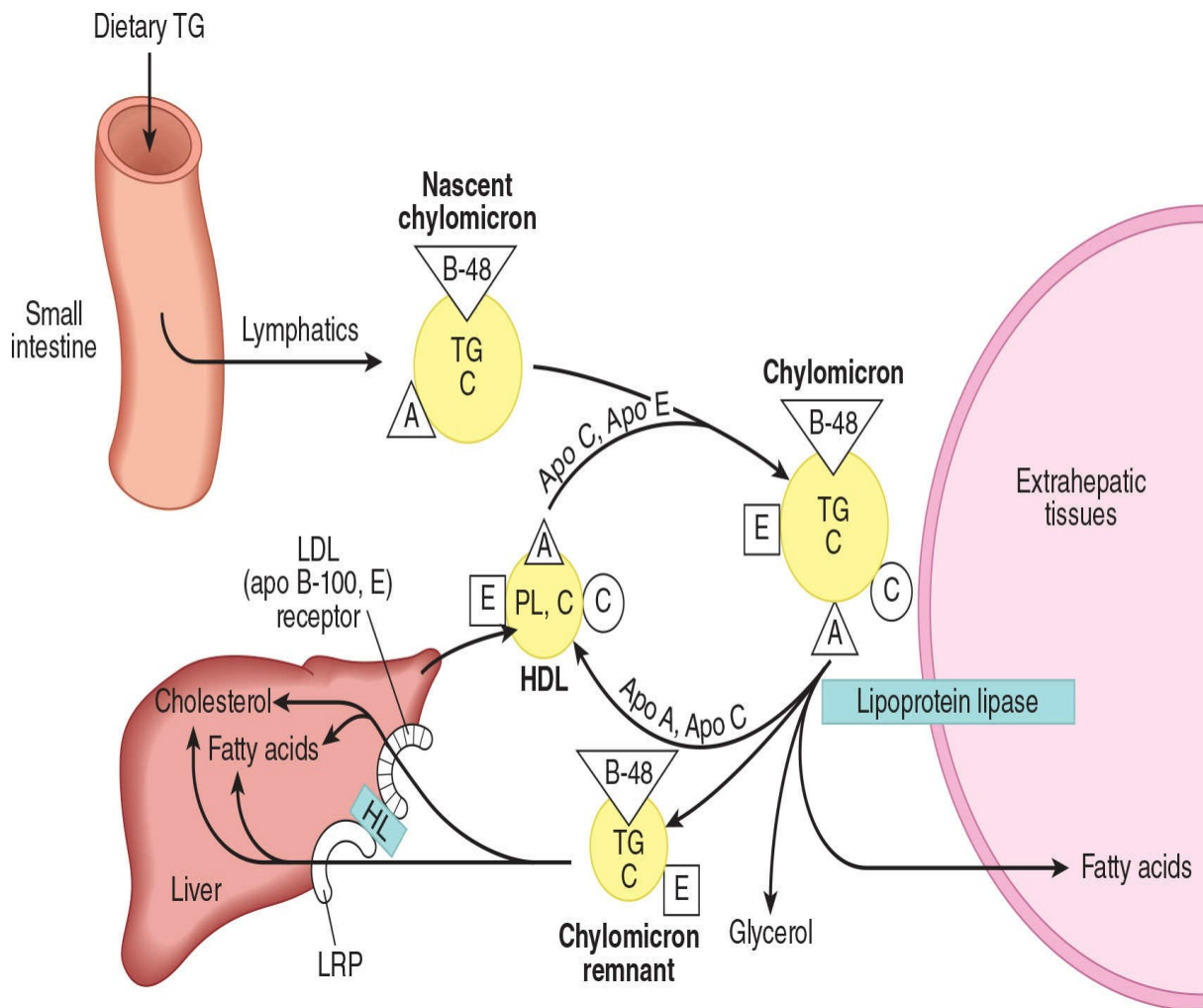

FIGURE 25–3 Metabolic fate of chylomicrons. (A, apolipoprotein A; B-48, apolipoprotein B-48; C, apolipoprotein C; C, cholesterol and cholesteryl ester; E, apolipoprotein E; HDL, high-density lipoprotein; HL, hepatic lipase; LRP, LDL-receptor–related protein; PL, phospholipid; TG, triacylglycerol.) Only the predominant lipids are shown.

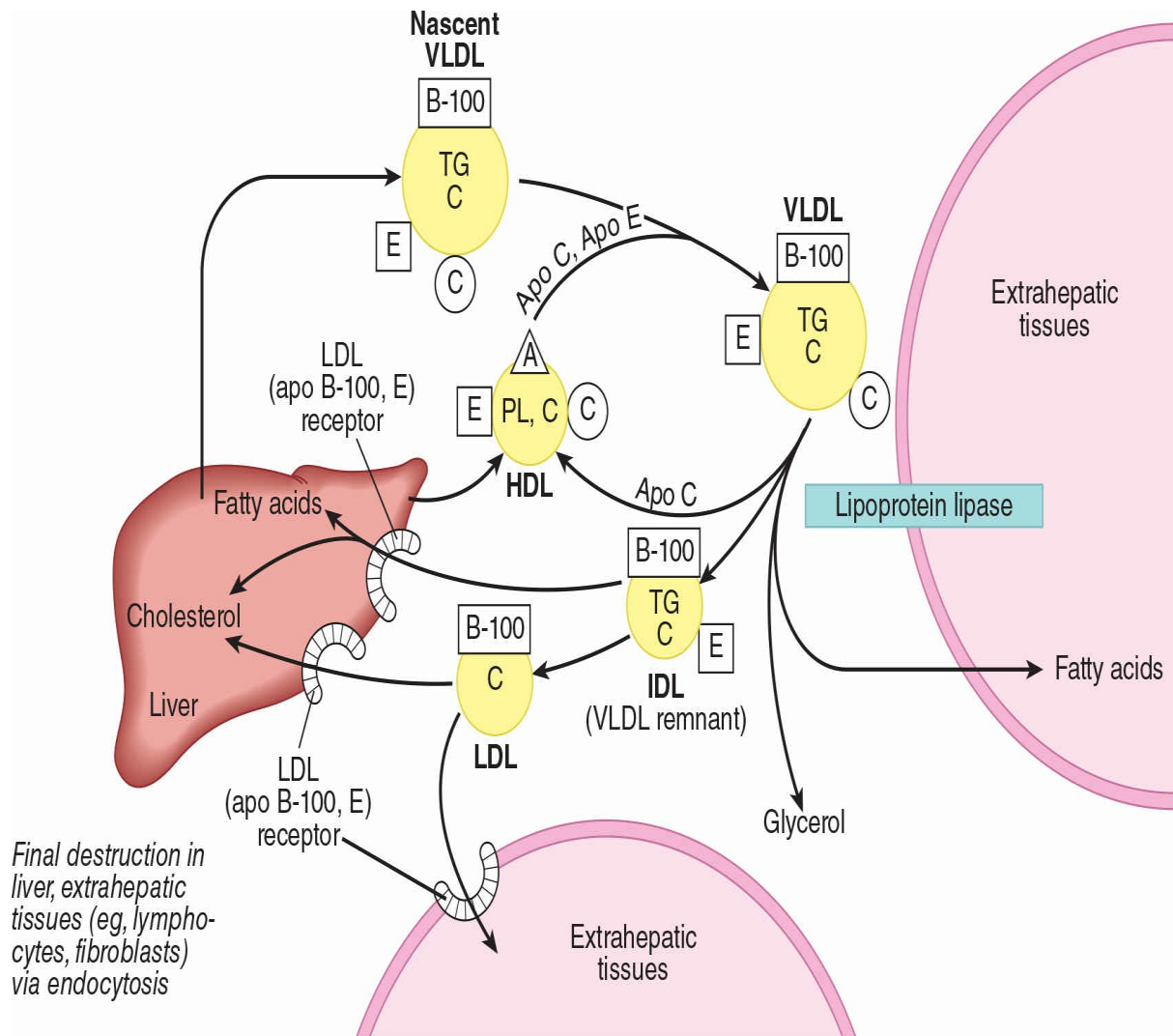

FIGURE 25–4 Metabolic fate of very-low-density lipoproteins (VLDL) and production of low-density lipoproteins (LDL). (A, apolipoprotein A; B-100, apolipoprotein B-100; C, apolipoprotein C; C, cholesterol and cholesteryl ester; E, apolipoprotein E; HDL, high-density lipoprotein; IDL, intermediate-density lipoprotein; PL, phospholipid; TG, triacylglycerol.) Only the predominant lipids are shown. It is possible that some IDL is also metabolized via the low-density lipoprotein receptor–related protein-1 (LRP-1.)

CHYLOMICRONS & VERY-LOW-DENSITY LIPOPROTEINS ARE RAPIDLY CATABOLIZED

The clearance of chylomicrons from the blood is rapid, the half-time of disappearance being under 1 hour in humans. Larger particles are catabolized more quickly than smaller ones. Fatty acids originating from chylomicron triacylglycerol are delivered mainly to adipose tissue, heart,

and muscle (80%), while ~20% goes to the liver. However, **the liver does not metabolize native chylomicrons or VLDL significantly**; thus, the fatty acids in the liver must be secondary to their metabolism in extrahepatic tissues.

Triacylglycerols of Chylomicrons & VLDL Are Hydrolyzed by Lipoprotein Lipase to Form Remnant Lipoproteins

Lipoprotein lipase is an enzyme located on the walls of blood capillaries, anchored to the endothelium by negatively charged proteoglycan chains of heparan sulfate. It has been found in heart, adipose tissue, spleen, lung, renal medulla, aorta, diaphragm, and lactating mammary gland, although it is not active in adult liver. It is not normally found in blood; however, following injection of **heparin**, lipoprotein lipase is released from its heparan sulfate-binding sites into the circulation. **Hepatic lipase** is bound to the sinusoidal surface of liver cells and is also released by heparin. This enzyme, however, does not react readily with chylomicrons or VLDL but is involved in chylomicron remnant and HDL metabolism (see below).

Both **phospholipids** and **apo C-II** are required as cofactors for lipoprotein lipase activity, while **apo A-II** and **apo C-III** act as inhibitors. Hydrolysis takes place while the lipoproteins are attached to the enzyme on the endothelium. Triacylglycerol is hydrolyzed progressively through a diacylglycerol to a monoacylglycerol and finally to FFA plus glycerol. Some of the released FFA return to the circulation, attached to albumin, but the bulk is transported into the tissue ([Figures 25–3](#) and [25–4](#)). Heart lipoprotein lipase has a low K_m for triacylglycerol, about one-tenth of that for the enzyme in adipose tissue. This enables the delivery of fatty acids from triacylglycerol to be **redirected from adipose tissue to the heart in the starved state** when the plasma triacylglycerol decreases. A similar redirection to the mammary gland occurs during lactation, allowing uptake of lipoprotein triacylglycerol fatty acid for **milk fat** synthesis. The **VLDL receptor** plays an important part in the delivery of fatty acids from VLDL triacylglycerol to adipocytes by binding VLDL and bringing it into close contact with lipoprotein lipase. In adipose tissue, **insulin** enhances lipoprotein lipase synthesis in adipocytes and its translocation to the luminal surface of the capillary endothelium.

Reaction with lipoprotein lipase results in the loss of 70 to 90% of the triacylglycerol of chylomicrons and in the loss of apo C (which returns to

HDL) but not apo E, which is retained. The resulting **chylomicron remnant** is about half the diameter of the parent chylomicron and is relatively enriched in cholesterol and cholesteryl esters because of the loss of triacylglycerol (Figure 25–3). Similar changes occur to VLDL, with the formation of **VLDL remnants** (also called **intermediate-density lipoprotein (IDL)**) (Figure 25–4).

The Liver Is Responsible for the Uptake of Remnant Lipoproteins

Chylomicron remnants are taken up by the liver by receptor-mediated endocytosis, and the cholesteryl esters and triacylglycerols are hydrolyzed and metabolized. Uptake is mediated by **apo E** (Figure 25–3), via two apo E-dependent receptors, the **LDL (apo B-100, E) receptor** and **LDL receptor–related protein-1 (LRP-1)**. Hepatic lipase has a dual role: (1) it acts as a ligand to facilitate remnant uptake and (2) it hydrolyzes remnant triacylglycerol and phospholipid.

After VLDL has been converted to IDL, the remnant particles may be taken up by the liver directly via the LDL (apo B-100, E) receptor, or they may be further metabolized to LDL in the circulation. Only one molecule of apo B-100 is present in each of these lipoprotein particles, and this is conserved during the transformations. Thus, each LDL particle is derived from a single precursor VLDL particle (Figure 25–4). In humans, a relatively large proportion of IDL forms LDL, accounting for the increased concentrations of LDL in humans compared with many other mammals.

LDL IS METABOLIZED VIA THE LDL RECEPTOR

The liver and many extrahepatic tissues express the **LDL (apo B-100, E) receptor**. It is so designated because it is specific for apo B-100 but not B-48, which lacks the carboxyl terminal domain of B-100 containing the LDL receptor ligand, and it also takes up lipoproteins rich in apo E. Approximately 30% of LDL is degraded in extrahepatic tissues and 70% in the liver. A positive correlation exists between the incidence of **atherosclerosis** and the plasma concentration of LDL cholesterol. The LDL (apoB-100, E) receptor is defective in **familial hypercholesterolemia**, a genetic condition in which blood LDL cholesterol levels are increased, causing premature atherosclerosis (Table 26–1). For further discussion of the regulation of the LDL receptor, see

HDL TAKES PART IN BOTH LIPOPROTEIN TRIACYLGLYCEROL & CHOLESTEROL METABOLISM

HDL is synthesized and secreted from both liver and intestine (**Figure 25–5**). However, apo C and apo E are synthesized in the liver and transferred from liver HDL to intestinal HDL when the latter enters the plasma. A major function of HDL is to act as a repository for the apo C and apo E required in the metabolism of chylomicrons and VLDL. Nascent HDL consists of discoid phospholipid bilayers containing apo A and free cholesterol. These lipoproteins are similar to the particles found in the plasma of patients with a deficiency of the plasma enzyme **LCAT** and in the plasma of patients with **obstructive jaundice**. LCAT—and the LCAT activator apo A-I—bind to the discoidal particles, and the surface phospholipid and free cholesterol are converted into cholesteryl esters and lysolecithin (see **Chapter 24**). The nonpolar cholesteryl esters move into the hydrophobic interior of the bilayer, whereas lysolecithin is transferred to plasma albumin. Thus, a nonpolar core is generated, forming a spherical, pseudomicellar HDL covered by a surface film of polar lipids and apolipoproteins. This aids the removal of excess unesterified cholesterol from lipoproteins and tissues as described below. The **class B scavenger receptor B1 (SR-B1)** has been identified as an **HDL receptor with a dual role in HDL metabolism**. In the liver and in steroidogenic tissues, it binds HDL via apo A-I, and cholesteryl ester is selectively delivered to the cells, although the particle itself, including apo A-I, is not taken up. In the tissues, on the other hand, SR-B1 mediates the acceptance of cholesterol effluxed from the cells by HDL, which then transports it to the liver for excretion via the bile (either as cholesterol or after conversion to bile acids) in the process known as **reverse cholesterol transport** (**Figure 25–5**). HDL₃, generated from discoidal HDL by the action of LCAT, accepts cholesterol from the tissues via the **SR-B1** and the cholesterol is then esterified by LCAT, increasing the size of the particles to form the less dense HDL₂. HDL₃ is then reformed, either after selective delivery of cholesteryl ester to the liver via the SR-B1 or by hydrolysis of HDL₂ phospholipid and triacylglycerol by hepatic lipase and endothelial lipase. This interchange of HDL₂ and HDL₃ is called the **HDL cycle** (**Figure 25–5**). Free apo A-I is released by these processes and forms **preβ-**

HDL after associating with a minimum amount of phospholipid and cholesterol. Surplus apo A-I is destroyed in the kidney. A second important mechanism for reverse cholesterol transport involves the **ATP-binding cassette transporters A1 (ABCA1)** and **G1 (ABCG1)**. These transporters are members of a family of transporter proteins that couple the hydrolysis of ATP to the binding of a substrate, enabling it to be transported across the membrane. ABCG1 mediates the transport of cholesterol from cells to HDL, while ABCA1 preferentially promotes efflux to poorly lipidated particles such as pre β -HDL or apo A-1, which are then converted to HDL₃ via discoidal HDL (Figure 25–5). Pre β -HDL is the most potent form of HDL inducing cholesterol efflux from the tissues.

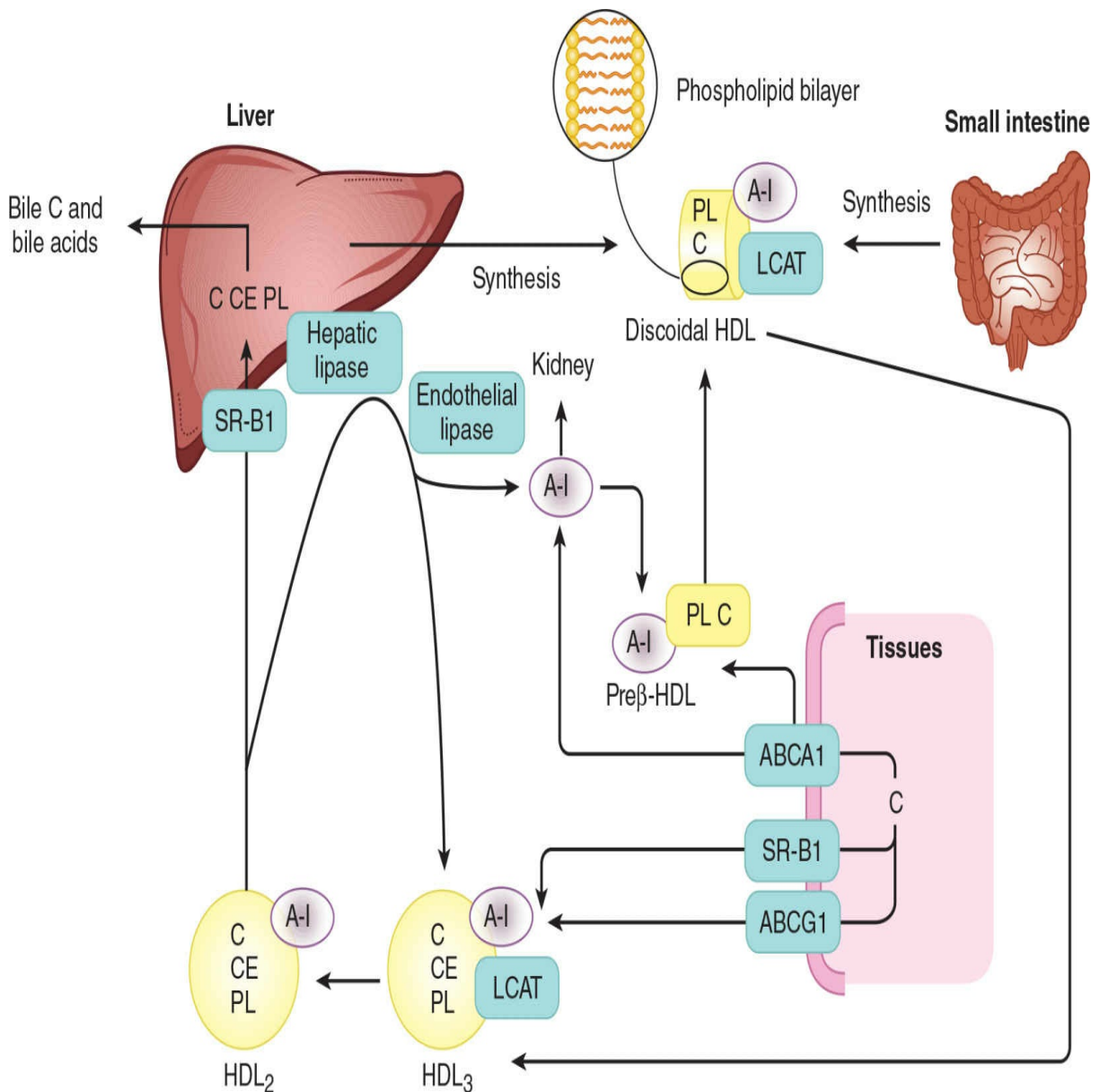

FIGURE 25–5 Metabolism of high-density lipoprotein (HDL) in reverse cholesterol transport. (A-I, apolipoprotein A-I; ABCA1, ATP-binding cassette transporter A1; ABCG1, ATP-binding cassette transporter G1; C, cholesterol; CE, cholesteryl ester; LCAT, lecithin:cholesterol acyltransferase; PL, phospholipid; SR-B1, scavenger receptor B1.) Pre β -HDL, HDL₂, HDL₃—see [Table 25–1](#). Surplus surface constituents from the action of lipoprotein lipase on chylomicrons and VLDL are another source of pre β -HDL.

HDL concentrations vary reciprocally with plasma triacylglycerol concentrations and directly with the activity of lipoprotein lipase. This may be due to surplus surface constituents, for example, phospholipid and apo A-I, being released during hydrolysis of chylomicrons and VLDL and contributing toward the formation of pre β -HDL and discoidal HDL. HDL₂ concentrations are **inversely related to the incidence of atherosclerosis**, possibly because they reflect the efficiency of reverse cholesterol transport. HDL_C (HDL₁) is found in the blood of diet-induced hypercholesterolemic animals. It is rich in cholesterol, and its sole apolipoprotein is apo E. It appears that all plasma lipoproteins are interrelated components of one or more metabolic cycles that together are responsible for the complex process of plasma lipid transport.

THE LIVER PLAYS A CENTRAL ROLE IN LIPID TRANSPORT & METABOLISM

The liver carries out the following major functions in lipid metabolism:

1. Facilitation of the digestion and absorption of lipids by the production of **bile** (see [Chapter 26](#)).
2. Active **synthesis and oxidation of fatty acids** (see [Chapters 22](#) and [23](#)) and also synthesis of triacylglycerols and phospholipids (see [Chapter 24](#)).
3. **Conversion of fatty acids to ketone bodies (ketogenesis)** (see [Chapter 22](#)).
4. **Synthesis and metabolism of plasma lipoproteins.**

Hepatic VLDL Secretion Is Related to Dietary & Hormonal Status

The cellular events involved in hepatic VLDL formation and secretion are shown in [Figure 25–6](#). VLDL assembly requires the synthesis of apo B-100 and a source of triacylglycerol. Apo B-100 is synthesized on polyribosomes and translocated to the lumen of the endoplasmic reticulum (ER) as it is formed. As the protein enters the lumen, it is lipidated with phospholipid with the aid of the **microsomal triacylglycerol transfer protein (MTP)**, which also facilitates the transfer of triacylglycerol across the ER membrane, and apo B-containing **VLDL2** (or precursor VLDL) particles are formed. The triacylglycerol is derived from lipolysis of cytosolic triacylglycerol lipid droplets followed by reesterification in a pathway requiring phospholipid derivatives and diacylglycerol acyl transferases. Triacylglycerol not used for VLDL1 formation is recycled to the cytosolic droplets. After assembly in the ER, VLDL2 are carried in coat protein II (COPII) vesicles (see [Chapter 49](#)) to the golgi, where they fuse with triacylglycerol-rich lipid droplets to produce **VLDL1**. Phosphatidic acid produced by the action of phospholipase D after activation by a small GTP-binding protein called **ADP-ribosylation factor-1 (ARF-1)** is needed for the formation of the triacylglycerol—rich particles and/or VLDL2. Although some VLDL2 particles may be secreted without fusion, most particles which leave the cell are in the form of VLDL1. These nascent VLDL then acquire apolipoproteins C and E from HDL in the circulation to become mature VLDL.

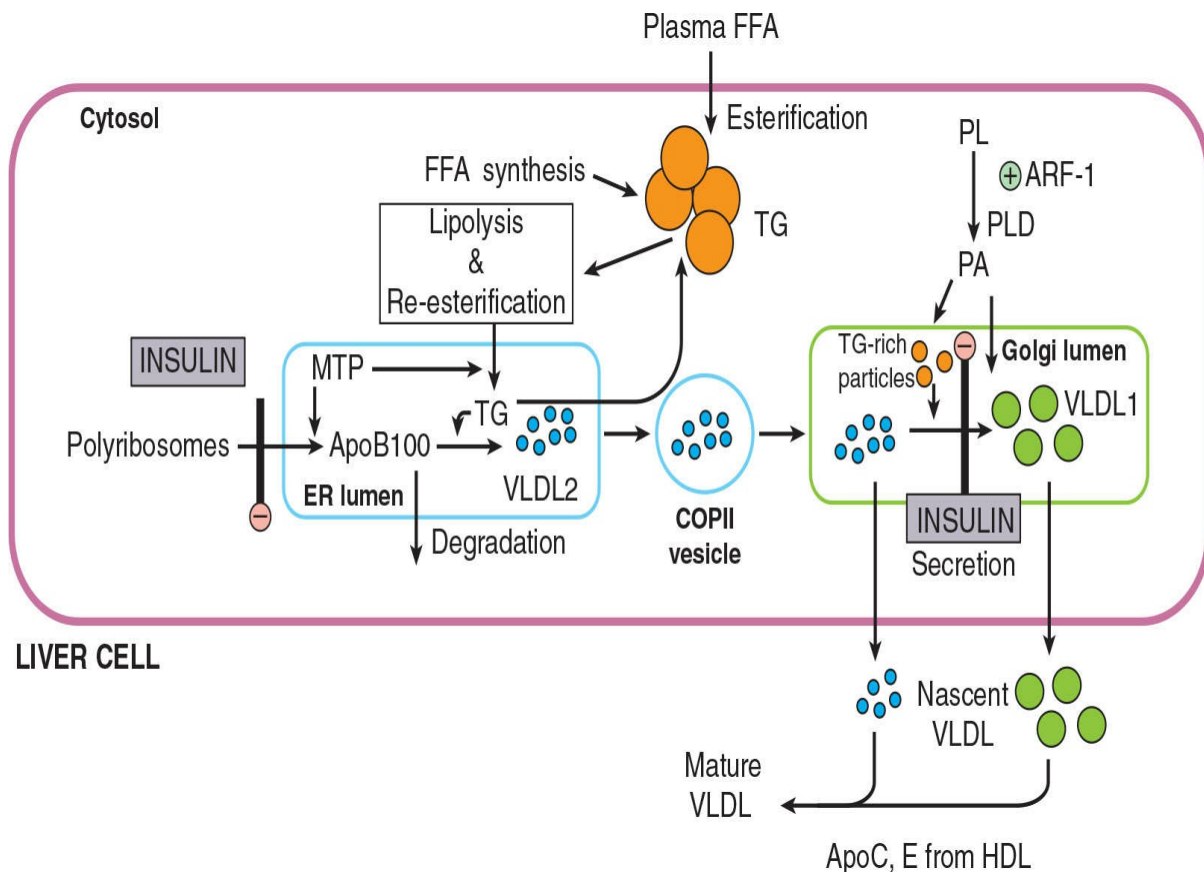

FIGURE 25–6 The assembly of very-low-density lipoprotein (VLDL) in the liver. (Apo, apolipoprotein; ARF-1, ADP-ribosylation factor-1; FFA, free fatty acids; HDL, high-density lipoproteins; MTP, microsomal triacylglycerol transfer protein; PA, phosphatidic acid; PL, phospholipid; PLD, phospholipase D; TG, triacylglycerol.) The pathways indicated underlie the events depicted in [Figure 25–2](#). Apo B-100 is synthesized on polyribosomes and is lipidated with PL by MTP as it enters the ER lumen. Any excess is degraded in proteasomes. TG derived from lipolysis of cytosolic lipid droplets followed by resynthesis is transferred into the ER lumen with the aid of MTP and interacts with apo B-100 forming VLDL2. Excess TG is recycled to the cytosolic lipid droplets. VLDL2 are translocated to the golgi in COPII vesicles where they fuse with TG-rich particles to form VLDL1. PA is produced by activation of PLD by ARF-1 and is incorporated into the TG-rich VLDL1 and/or VLDL2. Both VLDL1 and VLDL2 may be secreted into the blood. Insulin inhibits VLDL secretion by inhibiting apo B-100 synthesis and the formation of VLDL1 from VLDL2.

Triacylglycerol for VLDL formation is synthesized from FFA. The fatty acids used are derived from TG from two possible sources: (1) de novo synthesis within the liver from **acetyl-CoA** derived mainly from

carbohydrate (perhaps not so important in humans) and (2) uptake of **FFA** from the circulation. The first source is predominant in the well-fed condition, when fatty acid synthesis is high and the level of circulating FFAs is low. As triacylglycerol does not normally accumulate in the liver in these conditions, it must be inferred that it is transported from the liver in VLDL as rapidly as it is synthesized. FFAs from the circulation are the main source during starvation, the feeding of high-fat diets, or in diabetes mellitus, when hepatic lipogenesis is inhibited. Factors that enhance both the synthesis of triacylglycerol and the secretion of VLDL by the liver include (1) the fed state rather than the starved state; (2) the feeding of diets high in carbohydrate (particularly if they contain sucrose or fructose), leading to high rates of lipogenesis and esterification of fatty acids; (3) high levels of circulating FFA; (4) ingestion of ethanol; and (5) the presence of high concentrations of insulin and low concentrations of glucagon, which enhance fatty acid synthesis and esterification and inhibit their oxidation.

Insulin suppresses hepatic VLDL secretion both by inhibiting apo B-100 synthesis and the conversion of the smaller VLDL2 into VLDL1 by fusion with bulk triacylglycerol. Some other factors which are known to inhibit or prevent VLDL assembly in the liver include the antibiotic brefeldin A, which inhibits the action of ARF-1; the sulfonylurea hypoglycemic drug, tolbutamide, dietary ω 3 fatty acids (see [Chapter 21](#)), and orotic acid, an intermediate in the synthesis of pyrimidines (see [Chapter 33](#)) decrease the rate of triacylglycerol lipolysis; and a defect in the *MTP* gene. The regulation of VLDL formation in the liver is complex and involves interactions between hormonal and dietary factors that are not yet fully understood.

CLINICAL ASPECTS

Imbalance in the Rate of Triacylglycerol Formation & Export Causes Fatty Liver

For a variety of reasons, lipid—mainly as triacylglycerol—can accumulate in the liver ([Figure 25–6](#)). Extensive accumulation causes **fatty liver** and is regarded as a pathologic condition. **Nonalcoholic fatty liver disease (NAFLD)** is the most common liver disorder worldwide. When accumulation of lipid in the liver becomes chronic, inflammatory and fibrotic changes may develop leading to **nonalcoholic steatohepatitis (NASH)**, which can progress to liver diseases including **cirrhosis**,

hepatocarcinoma, and liver failure.

Fatty livers fall into two main categories. The first type is associated with **raised levels of plasma-free fatty acids** resulting from mobilization of fat from adipose tissue or from the hydrolysis of lipoprotein triacylglycerol by lipoprotein lipase in extrahepatic tissues. The production of VLDL does not keep pace with the increasing influx and esterification of free fatty acids, allowing triacylglycerol to accumulate, which in turn causes a fatty liver. This occurs during **starvation** and the feeding of **high-fat diets**. The ability to secrete VLDL may also be impaired (eg, in starvation). In uncontrolled **diabetes mellitus, twin lamb disease, and ketosis in cattle** fatty infiltration is sufficiently severe to cause visible pallor (fatty appearance) and enlargement of the liver with possible liver dysfunction.

The second type of fatty liver is usually due to a **metabolic block in the production of plasma lipoproteins**, thus allowing triacylglycerol to accumulate. Theoretically, the lesion may be due to (1) a block in apolipoprotein synthesis (or an increase in its degradation before it can be incorporated into VLDL), (2) a block in the synthesis of the lipoprotein from lipid and apolipoprotein, (3) a failure in provision of phospholipids that are found in lipoproteins, or (4) a failure in the secretory mechanism itself.

One type of fatty liver that has been studied extensively in rats is caused by a deficiency of **choline**, which has therefore been called a **lipotropic factor**. **Orotic acid** also causes fatty liver; it is believed to interfere with glycosylation of VLDL, thus inhibiting release, and may also impair the recruitment of triacylglycerol to the particles. A deficiency of vitamin E enhances the hepatic necrosis of the choline deficiency type of fatty liver. Added vitamin E or a source of **selenium** has a protective effect by combating lipid peroxidation. In addition to protein deficiency, essential fatty acid and vitamin deficiencies (eg, linoleic acid, pyridoxine, and pantothenic acid) can cause fatty infiltration of the liver.

Ethanol Also Causes Fatty Liver

Alcoholic fatty liver is the first stage in **alcoholic liver disease (ALD)** which is caused by **alcoholism** and ultimately leads to **cirrhosis**. The fat accumulation in the liver is caused by a combination of impaired fatty acid oxidation and increased lipogenesis, which is thought to be due to changes in the $[NADH]/[NAD^+]$ redox potential in the liver, and also to interference with the action of transcription factors regulating the

expression of the enzymes involved in the pathways. Oxidation of ethanol by **alcohol dehydrogenase** leads to excess production of NADH, which competes with reducing equivalents from other substrates, including fatty acids, for the respiratory chain. This inhibits their oxidation and causes increased esterification of fatty acids to form triacylglycerol, resulting in the fatty liver. Oxidation of ethanol leads to the formation of acetaldehyde, which is oxidized by **aldehyde dehydrogenase**, producing acetate. The increased (NADH)/(NAD⁺) ratio also causes increased (lactate)/(pyruvate), resulting in **hyperlacticacidemia**, which decreases excretion of uric acid, aggravating **gout**.

Some metabolism of ethanol takes place via a cytochrome P450–dependent microsomal ethanol oxidizing system (MEOS) involving NADPH and O₂. This system increases in activity in **chronic alcoholism** and may account for the increased metabolic clearance of ethanol in this condition, but may also promote the development of ALD. Ethanol also inhibits the metabolism of some drugs, for example, barbiturates, by competing for cytochrome P450–dependent enzymes.

In some Asian populations and Native Americans, alcohol consumption results in increased adverse reactions to acetaldehyde owing to a genetic defect of mitochondrial aldehyde dehydrogenase.

ADIPOSE TISSUE IS THE MAIN STORE OF TRIACYLGLYCEROL IN THE BODY

Triacylglycerols are stored in adipose tissue in large lipid droplets and are continually undergoing lipolysis (hydrolysis) and reesterification. These two processes are entirely different pathways involving different reactants and enzymes. This allows the processes of esterification or lipolysis to be regulated separately by many nutritional, metabolic, and hormonal factors. The balance between these two processes determines the magnitude of the FFA pool in adipose tissue, which in turn determines the level of FFA circulating in the plasma. Since the latter has most profound effects on the metabolism of other tissues, particularly liver and muscle, the factors operating in adipose tissue that regulate the outflow of FFA exert an influence far beyond the tissue itself. Moreover, since the discovery in the last 20 years that adipose tissue secretes hormones such as **leptin** and **adiponectin**, known as **adipokines**, its role as an endocrine organ has been recognized. Leptin regulates energy homeostasis by stimulating energy use and limiting food intake. If it is lacking, food intake may be

uncontrolled, causing obesity. Adiponectin modulates glucose and lipid metabolism in muscle and liver, and enhances the sensitivity of tissues to insulin.

The Provision of Glycerol-3-Phosphate Regulates Esterification: Lipolysis Is Controlled by Hormone-Sensitive Lipase

Triacylglycerol is synthesized from acyl-CoA and glycerol-3-phosphate (see [Figure 24-2](#)). Since the enzyme **glycerol kinase** is not expressed in adipose tissue, glycerol cannot be utilized for the provision of glycerol-3-phosphate, which must be supplied from glucose via glycolysis ([Figure 25-7](#)).

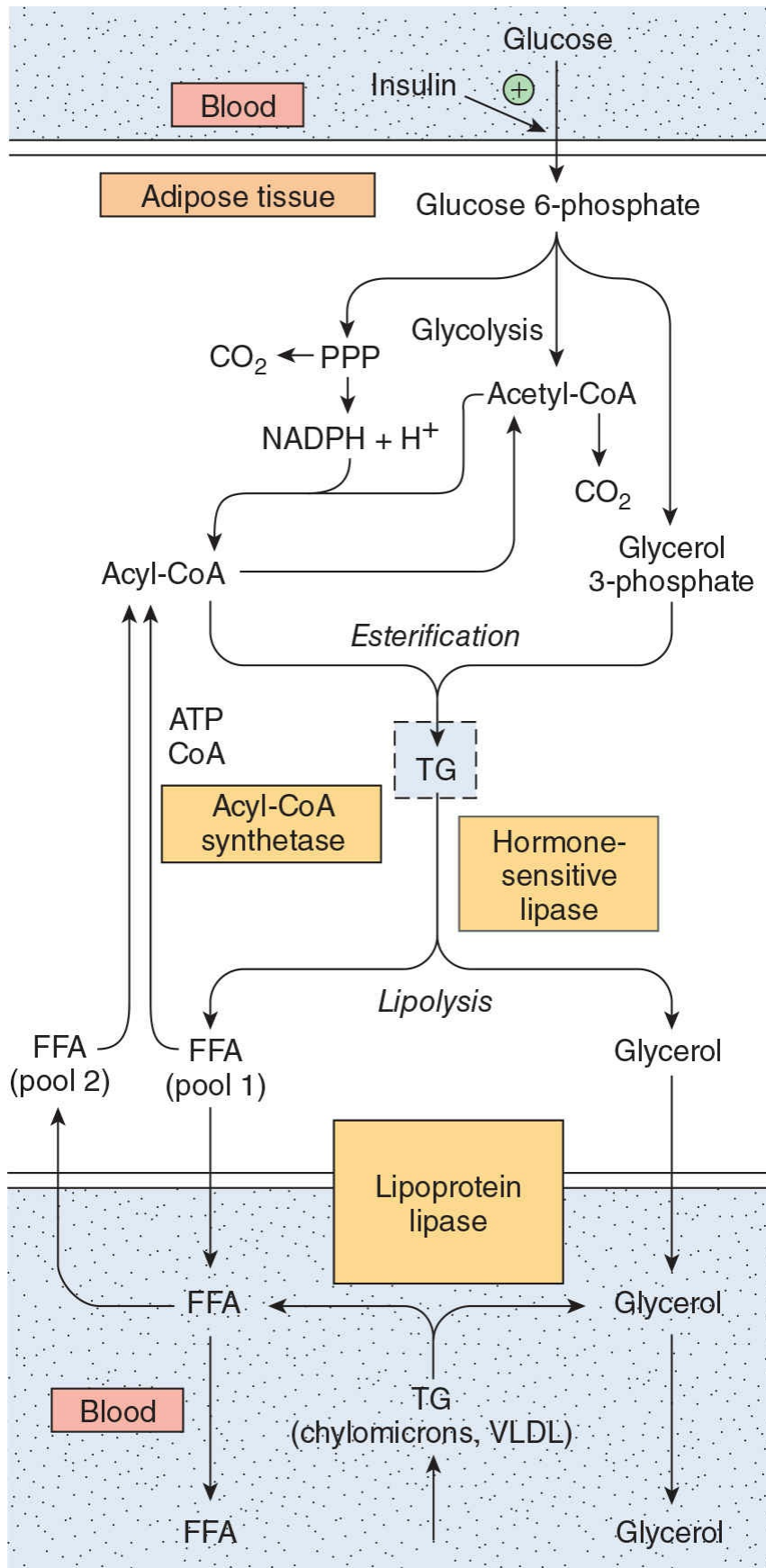

FIGURE 25–7 Triacylglycerol metabolism in adipose tissue.

Hormone-sensitive lipase is activated by ACTH, TSH, glucagon, epinephrine, norepinephrine, and vasopressin and inhibited by insulin, prostaglandin E₁, and nicotinic acid. Details of the formation of glycerol-3-phosphate from intermediates of glycolysis are shown in [Figure 24–2](#). (FFA, free fatty acids; PPP, pentose phosphate pathway; TG, triacylglycerol; VLDL, very-low-density lipoprotein.)

Triacylglycerol undergoes hydrolysis by a **hormone-sensitive lipase** to form FFA and glycerol. This lipase is distinct from lipoprotein lipase, which catalyzes lipoprotein triacylglycerol hydrolysis before its uptake into extrahepatic tissues (see above). Since the glycerol cannot be utilized, it enters the blood and is taken up and transported to tissues such as the liver and kidney, which possess an active glycerol kinase. The FFA formed by lipolysis can be reconverted in adipose tissue to acyl-CoA by **acyl-CoA synthetase** and reesterified with glycerol-3-phosphate to form triacylglycerol. Thus, **there is a continuous cycle of lipolysis and reesterification within the tissue** ([Figure 25–7](#)). However, when the rate of reesterification is not sufficient to match the rate of lipolysis, FFAs accumulate and diffuse into the plasma, where they bind to albumin and raise the concentration of plasma-free fatty acids.

Increased Glucose Metabolism Reduces the Output of FFA

When the utilization of glucose by adipose tissue is increased, the FFA outflow decreases. However, the release of glycerol continues, demonstrating that the effect of glucose is not mediated by reducing the rate of lipolysis. The effect is due to the provision of glycerol-3-phosphate, which enhances esterification of FFA. Glucose can take several pathways in adipose tissue, including oxidation to CO₂ via the citric acid cycle, oxidation in the pentose phosphate pathway, conversion to long-chain fatty acids, and formation of acylglycerol via glycerol-3-phosphate ([Figure 25–7](#)). When glucose utilization is high, a larger proportion of the uptake is oxidized to CO₂ and converted to fatty acids. However, as total glucose utilization decreases, the greater proportion of the glucose is directed to the formation of glycerol-3-phosphate for the esterification of acyl-CoA, which helps to minimize the efflux of FFA.

HORMONES REGULATE FAT MOBILIZATION

Adipose Tissue Lipolysis Is Inhibited by Insulin

The rate of release of FFA from adipose tissue is affected by many hormones that influence either the rate of esterification or the rate of lipolysis. **Insulin** inhibits the release of FFA from adipose tissue, which results in a fall in circulating plasma-free fatty acids. Insulin also enhances lipogenesis and the synthesis of acylglycerol and increases the oxidation of glucose to CO₂ via the pentose phosphate pathway. All of these effects are dependent on the presence of glucose and can be explained, to a large extent, on the basis of the ability of insulin to enhance the uptake of glucose into adipose cells via the **GLUT 4 transporter**. In addition, insulin increases the activity of the enzymes pyruvate dehydrogenase, acetyl-CoA carboxylase, and glycerol phosphate acyltransferase, reinforcing the effects of increased glucose uptake on the enhancement of fatty acid and acylglycerol synthesis. These three enzymes are regulated in a coordinate manner by phosphorylation–dephosphorylation mechanisms (see [Chapters 17, 23, and 24](#)).

Another principal action of insulin in adipose tissue is to inhibit the activity of **hormone-sensitive lipase**, reducing the release not only of FFA but also of glycerol. Adipose tissue is much more sensitive to insulin than many other tissues, and is thus a major site of insulin action in vivo.

Several Hormones Promote Lipolysis

Other hormones accelerate the release of FFA from adipose tissue and raise the plasma-free fatty acid concentration by increasing the rate of lipolysis of the triacylglycerol stores ([Figure 25–8](#)). These include **epinephrine, norepinephrine, glucagon, adrenocorticotrophic hormone (ACTH), α- and β-melanocyte-stimulating hormones (MSH), thyroid-stimulating hormone (TSH), growth hormone (GH), and vasopressin**. Many of these activate hormone-sensitive lipase. For an optimal effect, most of these lipolytic processes require the presence of **glucocorticoids** and **thyroid hormones**. These hormones act in a **facilitatory** or **permissive** capacity with respect to other lipolytic endocrine factors.

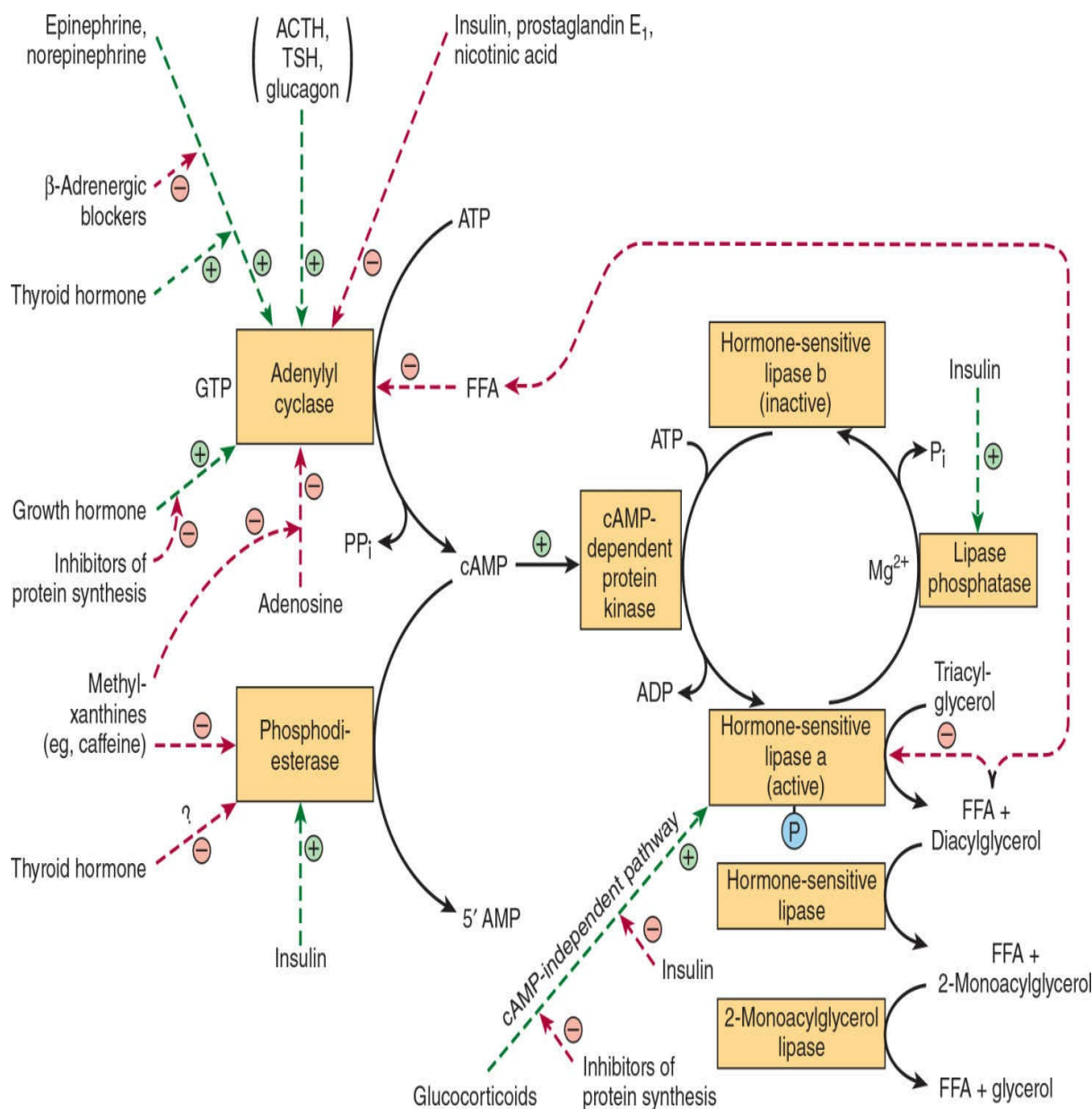

FIGURE 25–8 Control of adipose tissue lipolysis. (ACTH, adrenocorticotropin hormone; FFA, free fatty acids; TSH, thyroid-stimulating hormone.) The cascade sequence of reactions enables amplification at each step. The lipolytic stimulus is “switched off” by removal of the stimulating hormone; the action of lipase phosphatase; the inhibition of the lipase and adenylyl cyclase by high concentrations of FFA; the inhibition of adenylyl cyclase by adenosine; and the removal of cAMP by the action of phosphodiesterase. ACTH, TSH, and glucagon may not activate adenylyl cyclase in vivo since the concentration of each hormone required in vitro is much higher than is found in the circulation. Positive (+) and negative (–) regulatory effects are represented by broken lines and substrate flow by solid lines.

The hormones that act rapidly in promoting lipolysis, that is, catecholamines (epinephrine and norepinephrine), do so by stimulating the activity of **adenylyl cyclase**, the enzyme that converts ATP to cAMP. The mechanism is analogous to that responsible for hormonal stimulation of glycogenolysis (see [Chapter 18](#)). cAMP, by stimulating **cAMP-dependent protein kinase**, activates hormone-sensitive lipase. Thus, processes which destroy or preserve cAMP influence lipolysis. cAMP is degraded to 5'-AMP by the enzyme **cyclic 3',5'-nucleotide phosphodiesterase**. This enzyme is inhibited by methylxanthines such as **caffeine** and **theophylline**. **Insulin** antagonizes the effect of the lipolytic hormones. Lipolysis appears to be more sensitive to changes in concentration of insulin than are glucose utilization and esterification. The antilipolytic effects of insulin, nicotinic acid, and prostaglandin E₁ are accounted for by inhibition of the synthesis of cAMP at the adenylyl cyclase site, acting through a G_i protein. Insulin also stimulates phosphodiesterase and the lipase phosphatase that inactivates hormone-sensitive lipase. The effect of growth hormone in promoting lipolysis is dependent on synthesis of proteins involved in the formation of cAMP. Glucocorticoids promote lipolysis via synthesis of new lipase protein by a cAMP-independent pathway, which may be inhibited by insulin, and also by promoting transcription of genes involved in the cAMP signal cascade. These findings help to explain the role of the pituitary gland and the adrenal cortex in enhancing fat mobilization. The sympathetic nervous system, through liberation of norepinephrine in adipose tissue, plays a central role in the mobilization of FFA. Thus, the increased lipolysis caused by many of the factors described above can be reduced or abolished by denervation of adipose tissue or by ganglionic blockade.

Perilipin Regulates the Balance Between Triacylglycerol Storage and Lipolysis in Adipocytes

Perilipin, a protein involved in the formation of lipid droplets in adipocytes, inhibits lipolysis in basal conditions by preventing access of the lipase enzymes to the stored triacylglycerols. On stimulation with hormones which promote triacylglycerol degradation, however, the protein becomes phosphorylated and changes its conformation, exposing the lipid droplet surface to hormone-sensitive lipase and thus promoting lipolysis. Perilipin, therefore, enables the storage and breakdown of triacylglycerol to be coordinated according to the metabolic needs of the body.

Human Adipose Tissue May Not Be an Important Site of Lipogenesis

In adipose tissue, there is no significant incorporation of glucose or pyruvate into long-chain fatty acids, ATP-citrate lyase, a key enzyme in lipogenesis, does not appear to be present, and other lipogenic enzymes—for example, glucose-6-phosphate dehydrogenase and the malic enzyme—do not undergo adaptive changes. Indeed, it has been suggested that in humans there is a “**carbohydrate excess syndrome**” due to a unique limitation in the ability to dispose of excess carbohydrate by lipogenesis. In birds, lipogenesis is confined to the liver, where it is particularly important in providing lipids for egg formation, stimulated by estrogens.

BROWN ADIPOSE TISSUE PROMOTES THERMOGENESIS

Brown adipose tissue (BAT) is a specialized form of adipose tissue involved in metabolism, and in **thermogenesis** (heat generation). Thus, it is extremely active in some species, for example, during arousal from hibernation, in animals exposed to cold (nonshivering thermogenesis), and in heat production in the newborn. Though not a prominent tissue in humans, it is present in normal individuals. BAT is characterized by a well-developed blood supply and a high content of mitochondria and cytochromes, but low activity of ATP synthase. Metabolic emphasis is placed on oxidation of both glucose and fatty acids. **Norepinephrine** liberated from sympathetic nerve endings is important in increasing lipolysis in the tissue and increasing synthesis of lipoprotein lipase to enhance utilization of triacylglycerol-rich lipoproteins from the circulation. Oxidation and phosphorylation are not coupled in mitochondria of this tissue because of the presence of a thermogenic uncoupling protein, thermogenin (also called uncoupling protein 1 [UCP1]) and the phosphorylation that does occur is at the substrate level, for example, at the succinate thiokinase step and in glycolysis. Thus, **oxidation produces much heat, and little free energy is trapped in ATP. Thermogenin** acts as a proton conductance pathway dissipating the electrochemical potential across the mitochondrial membrane (**Figure 25–9**). Recent research has shown that BAT activity is inversely related to body fat content, and thus is a potential target for the treatment of obesity and related metabolic disorders.

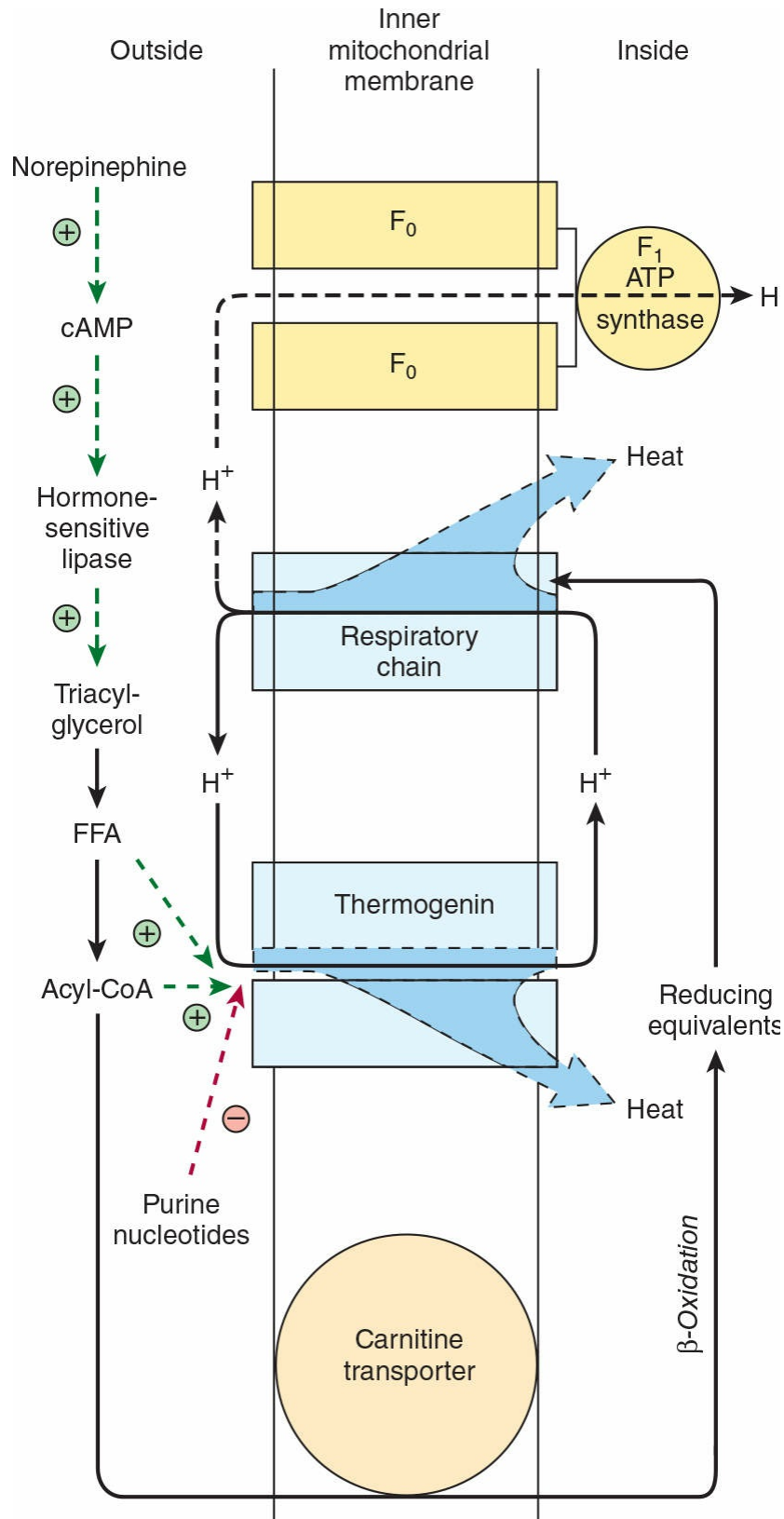

FIGURE 25–9 Thermogenesis in brown adipose tissue. Activity of the respiratory chain results in the translocation of protons from the mitochondrial matrix into the intermembrane space (see Figure 13–7). The presence of thermogenin (UCP1) in brown adipose tissue enables the

protons to flow back into the matrix without passing through the F_1 ATP synthase and the energy generated is dissipated as heat instead of being captured as ATP. The passage of H^+ via thermogenin is inhibited by purine nucleotides when brown adipose tissue is unstimulated. Under the influence of norepinephrine, the inhibition is removed by the production of free fatty acids (FFA) and acyl-CoA. Note the dual role of acyl-CoA in both facilitating the action of thermogenin and supplying reducing equivalents for the respiratory chain. \oplus and \ominus signify positive or negative regulatory effects.

SUMMARY

- Since nonpolar lipids are insoluble in water, for transport between the tissues in the aqueous blood plasma, they are combined with amphipathic lipids and proteins to make water-miscible lipoproteins.
- Four major groups of lipoproteins are recognized. Chylomicrons transport lipids resulting from digestion and absorption. VLDLs transport triacylglycerol from the liver. LDLs deliver cholesterol to the tissues, and HDLs remove cholesterol from the tissues and return it to the liver for excretion in the process known as reverse cholesterol transport.
- Chylomicrons and VLDL are metabolized by hydrolysis of their triacylglycerol, leaving lipoprotein remnants in the circulation. These are taken up by liver, but some of the remnants (IDL) resulting from VLDL form LDL are taken up by the liver and other tissues via the LDL receptor.
- Apolipoproteins constitute the protein moiety of lipoproteins. They act as enzyme activators (eg, apo C-II and apo A-I) or as ligands for cell receptors (eg, apo A-I, apo E, and apo B-100).
- Triacylglycerol is the main storage lipid in adipose tissue. Upon mobilization, FFA and glycerol are released. FFAs are an important fuel source.
- Brown adipose tissue is the site of “nonshivering thermogenesis.” It is found in hibernating and newborn animals and is present in adult humans. Thermogenesis results from the presence of UCP1, thermogenin, in the inner mitochondrial membrane.

REFERENCES

Eljamil AS: *Lipid Biochemistry: For Medical Sciences*. iUniverse, 2015.

Francis G: High density lipoproteins: metabolism and protective roles against atherosclerosis. In *Biochemistry of Lipids, Lipoproteins and Membranes*, 6th ed. Ridgway N, McLeod R (editors). Academic Press, 2015:437-459.

McLeod RS, Yao Z: Assembly and secretion of triacylglycerol-rich lipoproteins. In *Biochemistry of Lipids, Lipoproteins and Membranes*, 6th ed. Ridgway N, McLeod R (editors). Academic Press, 2015:460-488.

Cholesterol Synthesis, Transport, & Excretion

Kathleen M. Botham, PhD, DSc & Peter A. Mayes, PhD, DSc

OBJECTIVES

After studying this chapter, you should be able to:

- Explain the importance of cholesterol as an essential structural component of cell membranes and as a precursor of all other steroids in the body, and indicate its pathologic role in cholesterol gallstone disease and atherosclerosis development.
- Identify the five stages in the biosynthesis of cholesterol from acetyl-CoA.
- Indicate the role of 3-hydroxy-3-methylglutaryl-CoA reductase (HMG-CoA reductase) in controlling the rate of cholesterol synthesis and explain the mechanisms by which its activity is regulated.
- Explain that cholesterol balance in cells is tightly regulated and indicate the factors involved in maintaining the correct balance.
- Explain the role of plasma lipoproteins, including chylomicrons, very-low-density lipoprotein (VLDL), low-density lipoprotein (LDL), and high-density lipoprotein (HDL), in the transport of

cholesterol between tissues in the plasma.

- Name the two main primary bile acids found in mammals, outline the pathways by which they are synthesized from cholesterol in the liver.
- Explain the importance of bile acid synthesis not only in the digestion and absorption of fats but also as a major excretory route for cholesterol.
- Indicate how secondary bile acids are produced from primary bile acids by intestinal bacteria.
- Explain what is meant by the “enterohepatic circulation” and why it is important.
- Identify various factors related to plasma cholesterol concentrations that affect the risk of coronary heart disease, including diet and lifestyle and the class of lipoprotein in which it is carried.
- Give examples of inherited and noninherited conditions affecting lipoprotein metabolism that cause hypo- or hyperlipoproteinemia.

BIOMEDICAL IMPORTANCE

Cholesterol is present in tissues and in plasma either as free cholesterol or combined with a long-chain fatty acid as cholesteryl ester, the storage form. In plasma, both forms are transported in lipoproteins (see [Chapter 25](#)). Cholesterol is an amphipathic lipid and as such is an essential structural component of membranes, where it is important for the maintenance of the correct permeability and fluidity, and of the outer layer of plasma lipoproteins. It is synthesized in many tissues from acetyl-CoA and is the precursor of all other steroids in the body, including **corticosteroids, sex hormones, bile acids, and vitamin D**. As a typical product of animal metabolism, cholesterol occurs in foods of animal origin such as egg yolk, meat, liver, and brain. Plasma **low-density lipoprotein (LDL)** is the vehicle that supplies cholesterol and cholesteryl ester to many tissues. Free cholesterol is removed from tissues by plasma **high-density lipoprotein (HDL)** and transported to the liver, where it is eliminated from the body either unchanged or after conversion to bile acids in the process known as **reverse cholesterol transport** (see [Chapter 25](#)). Cholesterol is a major constituent of **gallstones**. However, its chief role in pathologic processes is as a factor in the development of **atherosclerosis** of vital arteries, causing cerebrovascular, coronary, and

peripheral vascular disease.

CHOLESTEROL IS BIOSYNTHEZED FROM ACETYL-CoA

A little more than half the cholesterol of the body arises by synthesis (about 700 mg/d), and the remainder is provided by the average diet. The liver and intestine account for approximately 10% each of total synthesis in humans. Virtually all tissues containing nucleated cells are capable of cholesterol synthesis, which occurs in the endoplasmic reticulum and the cytosolic compartments.

Acetyl-CoA Is the Source of All Carbon Atoms in Cholesterol

Cholesterol is a 27-carbon compound consisting of four rings and a side chain (see [Figure 21–19](#)). It is synthesized from acetyl-CoA by a lengthy pathway that may be divided into five steps: (1) synthesis of **mevalonate** from acetyl-CoA ([Figure 26–1](#)); (2) formation of **isoprenoid units** from mevalonate by loss of CO₂ ([Figure 26–2](#)); (3) condensation of six isoprenoid units form **squalene** ([Figure 26–2](#)); (4) cyclization of squalene gives rise to the parent steroid, **lanosterol**; (5) formation of cholesterol from lanosterol ([Figure 26–3](#)).

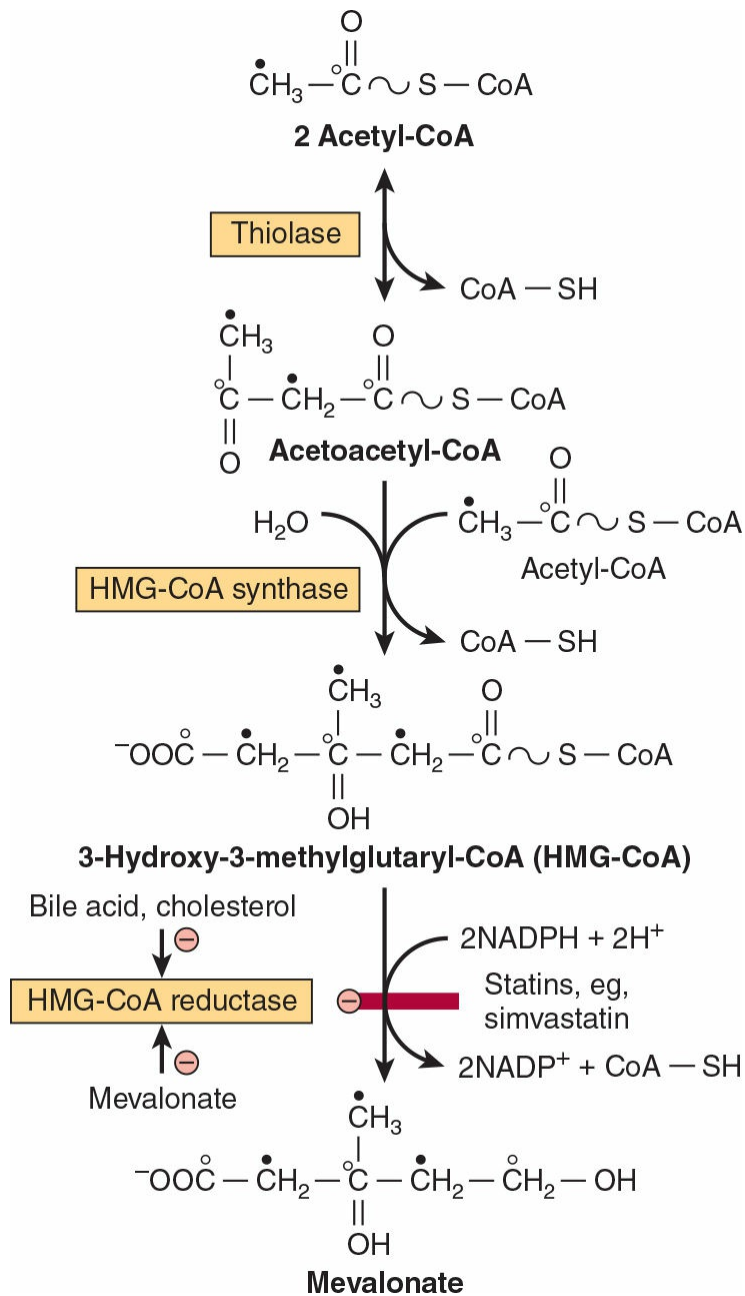

FIGURE 26–1 Biosynthesis of mevalonate. HMG-CoA reductase is inhibited by statins. The open and solid circles indicate the fate of each of the carbons in the acetyl moiety of acetyl-CoA.

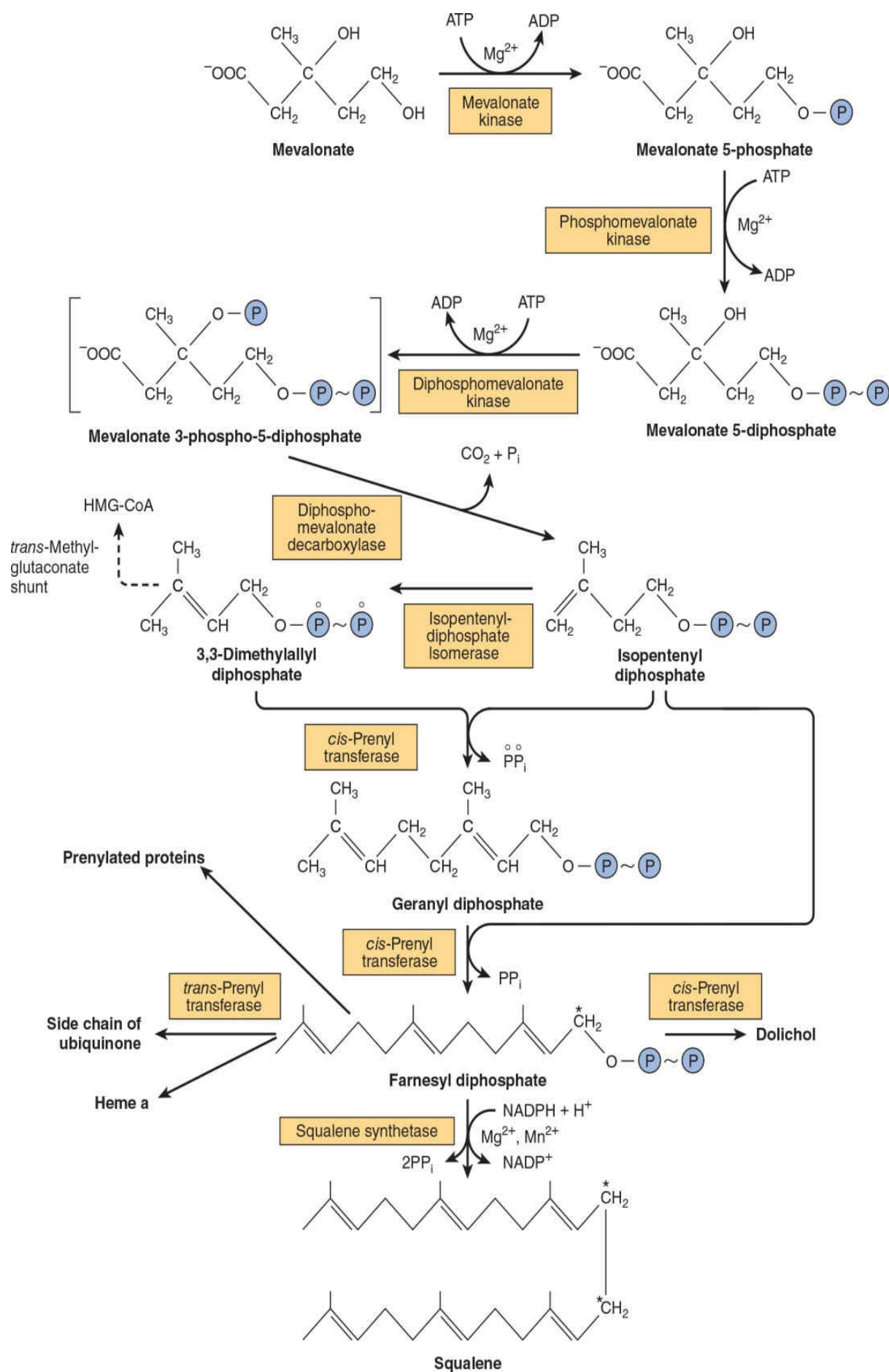

FIGURE 26–2 Biosynthesis of squalene, ubiquinone, dolichol, and other polyisoprene derivatives. (HMG, 3-hydroxy-3-methylglutaryl.) A farnesyl residue is present in heme of a cytochrome oxidase. The carbon marked with an asterisk becomes C₁₁ or C₁₂ in squalene. Squalene synthetase is a microsomal enzyme; all other enzymes indicated are soluble cytosolic proteins, and some are found in peroxisomes.

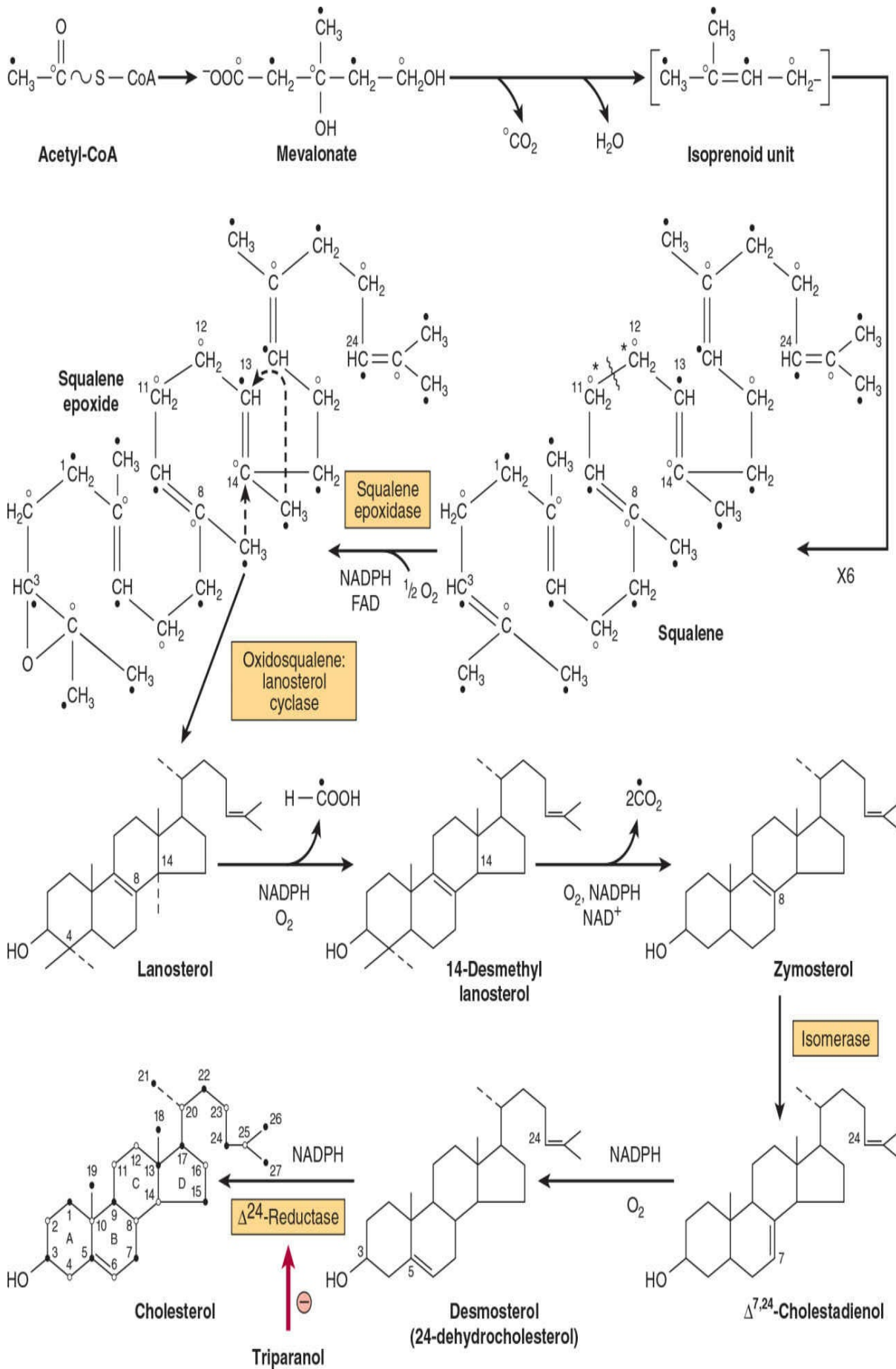

FIGURE 26–3 Biosynthesis of cholesterol. The numbered positions are those of the steroid nucleus and the open and solid circles indicate the fate of each of the carbons in the acetyl moiety of acetyl-CoA. (*Refer to labeling of squalene in Figure 26–2.)

Step 1—Biosynthesis of Mevalonate: HMG-CoA (3-hydroxy-3-methylglutaryl-CoA) is formed by the reactions used in mitochondria to synthesize ketone bodies (see Figure 22–7). However, since cholesterol synthesis is extramitochondrial, the two pathways are distinct. Initially, two molecules of acetyl-CoA condense to form acetoacetyl-CoA catalyzed by cytosolic **thiolase**. Acetoacetyl-CoA condenses with a further molecule of acetyl-CoA catalyzed by **HMG-CoA synthase** to form HMG-CoA, which is reduced to **mevalonate** by NADPH in a reaction catalyzed by **HMG-CoA reductase**. This last step is the principal regulatory step in the pathway of cholesterol synthesis and is the site of action of the most effective class of cholesterol-lowering drugs, the statins, which are HMG-CoA reductase inhibitors (Figure 26–1).

Step 2—Formation of Isoprenoid Units: Mevalonate is phosphorylated sequentially using ATP by three kinases, and after decarboxylation (Figure 26–2) of the active isoprenoid unit, **isopentenyl diphosphate**, is formed.

Step 3—Six Isoprenoid Units Form Squalene: Isopentenyl diphosphate is isomerized by a shift of the double bond to form **dimethylallyl diphosphate**, and then condensed with another molecule of isopentenyl diphosphate to form the 10-carbon intermediate **geranyl diphosphate** (Figure 26–2). A further condensation with isopentenyl diphosphate forms **farnesyl diphosphate**. Two molecules of farnesyl diphosphate condense at the diphosphate end to form **squalene**. Initially, inorganic pyrophosphate is eliminated, forming presqualene diphosphate, which is then reduced by NADPH with elimination of a further inorganic pyrophosphate molecule.

Step 4—Formation of Lanosterol: Squalene can fold into a structure that closely resembles the steroid nucleus (Figure 26–3). Before ring closure occurs, squalene is converted to squalene 2,3-epoxide by a mixed-function oxidase in the endoplasmic reticulum, **squalene epoxidase**. The methyl group on C₁₄ is transferred to C₁₃ and that on C₈ to C₁₄ as cyclization occurs, catalyzed by **oxidosqualene-lanosterol cyclase**.

Step 5—Formation of Cholesterol: The formation of cholesterol from **lanosterol** takes place in the membranes of the endoplasmic reticulum and

involves changes in the steroid nucleus and the side chain (Figure 26–3). The methyl groups on C₁₄ and C₄ are removed to form 14-desmethyl lanosterol and then zymosterol. The double bond at C₈—C₉ is subsequently moved to C₅—C₆ in two steps, forming **desmosterol**. Finally, the double bond of the side chain is reduced, producing cholesterol.

Farnesyl Diphosphate Gives Rise to Dolichol & Ubiquinone

The polyisoprenoids, **dolichol** (see Figure 21–22 and Chapter 46) and **ubiquinone** (see Figure 13–6) are formed from farnesyl diphosphate by the further addition of up to 16 (dolichol) or 3 to 7 (ubiquinone) isopentenyl diphosphate residues (Figure 26–2). Some **GTP-binding proteins** in the cell membrane are prenylated with farnesyl or geranylgeranyl (20 carbon) residues. **Protein prenylation** is believed to facilitate the anchoring of proteins into lipid membranes and may also be involved in protein–protein interactions and membrane-associated protein trafficking.

CHOLESTEROL SYNTHESIS IS CONTROLLED BY REGULATION OF HMG-CoA REDUCTASE

Cholesterol synthesis is tightly controlled by regulation at the HMG-CoA reductase step. The activity of the enzyme is inhibited by mevalonate, the immediate product of the reaction, and by cholesterol, the main product of the pathway. Thus, increased intake of cholesterol from the diet leads to a decrease in *de novo* synthesis, especially in the liver. Regulatory mechanisms include both modulation of the synthesis of enzyme protein and posttranslational modification. Cholesterol and metabolites repress transcription HMG-CoA reductase mRNA via inhibition of a **sterol regulatory element-binding protein (SREBP)** transcription factor. SREBPs are a family of proteins that regulate the transcription of a range of genes involved in the cellular uptake and metabolism of cholesterol and other lipids. SREBP activation is inhibited by insulin-induced gene (**Insig**), a protein whose expression, as its name indicates, is induced by insulin and is present in the endoplasmic reticulum. Insig also promotes degradation of HMG-CoA reductase. A **diurnal variation** occurs both in cholesterol synthesis and reductase activity. Short-term changes in enzyme

activity, however, are brought about by posttranslational modification (**Figure 26–4**). **Insulin** or **thyroid hormone** increases HMG-CoA reductase activity, whereas **glucagon** or **glucocorticoids** decrease it. Activity is reversibly modified by phosphorylation–dephosphorylation mechanisms, some of which may be cAMP-dependent and therefore immediately responsive to glucagon. **AMP-activated protein kinase (AMPK)** (formerly called HM-CoA reductase kinase) phosphorylates and inactivates HMG-CoA reductase. AMPK is activated via phosphorylation by **AMPK kinase (AMPKK)** and allosteric modification by AMP.

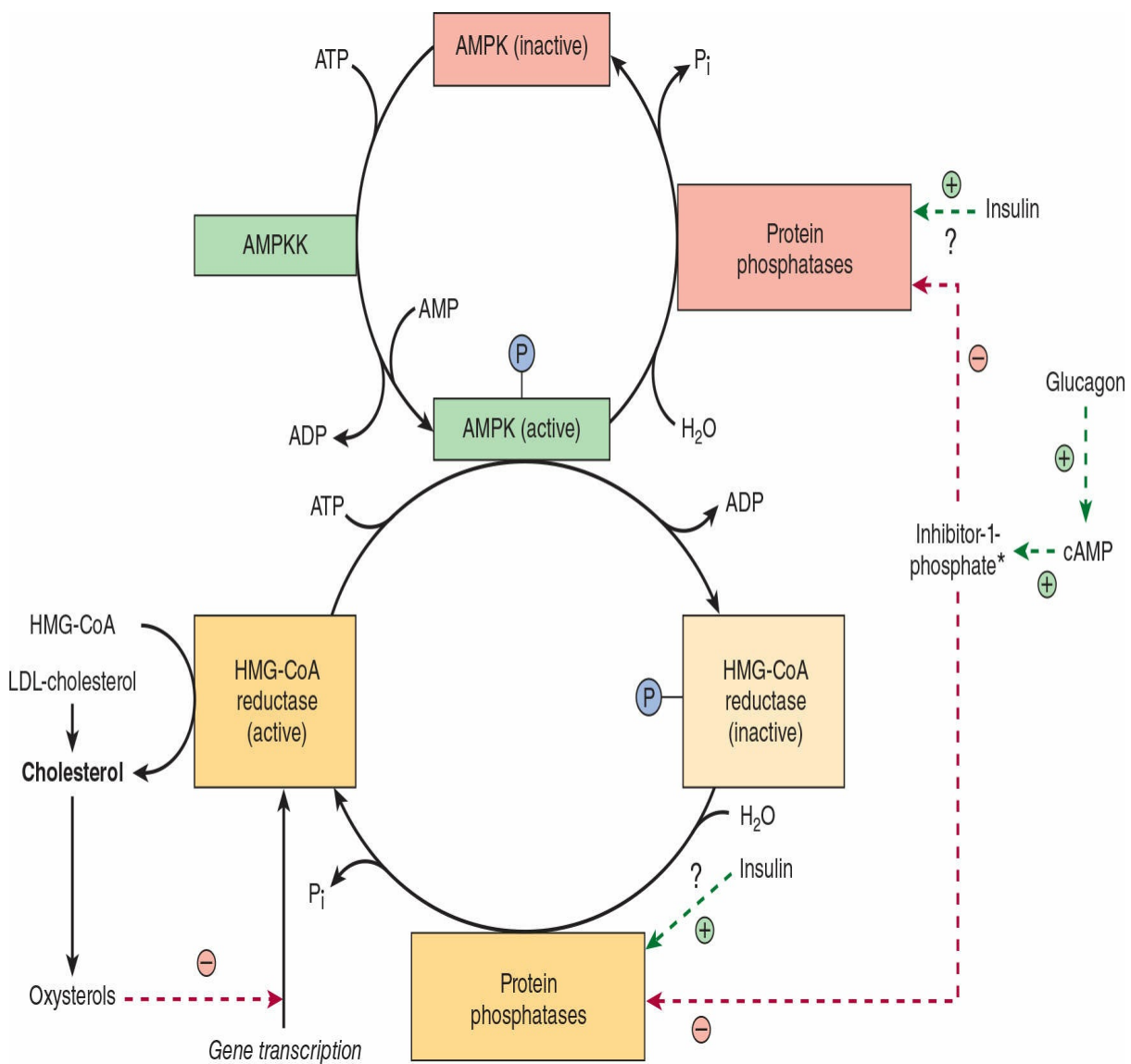

FIGURE 26–4 Possible posttranslational mechanisms in the regulation of cholesterol synthesis by HMG-CoA reductase. Insulin has a dominant role compared with glucagon. (AMPK, AMP-activated protein kinase; AMPKK, AMP-activated protein kinase kinase.) *See [Figure 18–6](#).

MANY FACTORS INFLUENCE THE CHOLESTEROL BALANCE IN TISSUES

In tissues, cholesterol balance is regulated as follows (**Figure 26–5**): An increase in cell cholesterol is caused by uptake of cholesterol-containing lipoproteins by receptors, for example, the LDL receptor or scavenger receptors such as CD36, uptake of free cholesterol from cholesterol-rich lipoproteins to the cell membrane, cholesterol synthesis, and hydrolysis of cholesteryl esters by the enzyme **cholesteryl ester hydrolase**. A decrease is due to efflux of cholesterol from the membrane to HDL via the ABCA1, ABCG1, or SR-B1 (see **Figure 25–5**); esterification of cholesterol by **ACAT** (acyl-CoA:cholesterol acyltransferase); and utilization of cholesterol for synthesis of other steroids, such as hormones, or bile acids in the liver.

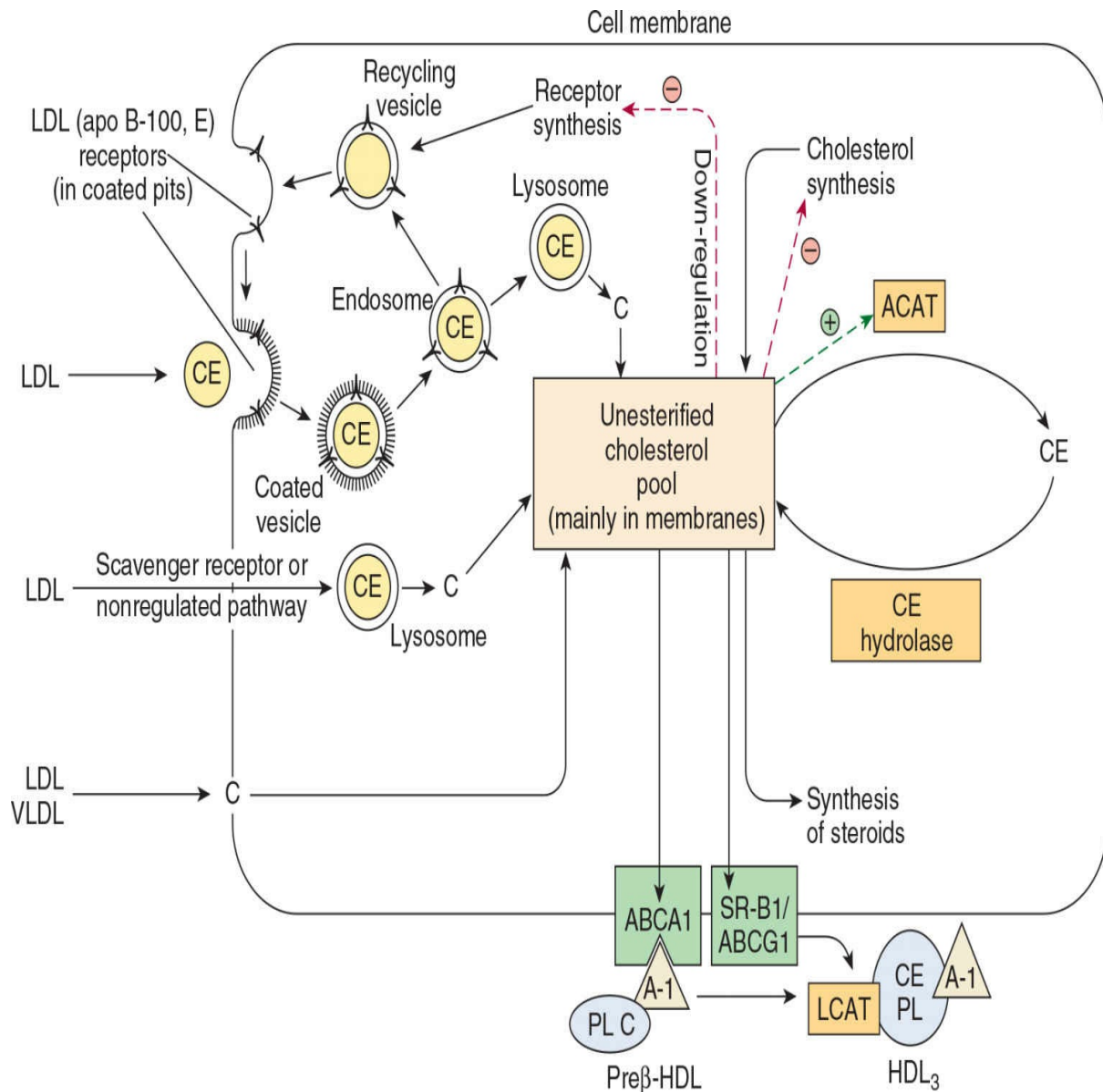

FIGURE 26–5 Factors affecting cholesterol balance at the cellular level. Reverse cholesterol transport may be mediated via the ABCA1 transporter protein (with pre β -HDL as the exogenous acceptor) or the SR-B1 or ABCG1 (with HDL₃ as the exogenous acceptor). (ACAT, acyl-CoA:cholesterol acyltransferase; A-I, apolipoprotein A-I; C, cholesterol; CE, cholesteryl ester; LCAT, lecithin:cholesterol acyltransferase; LDL, low-density lipoprotein; PL, phospholipid; VLDL, very-low-density lipoprotein.) LDL and HDL are not shown to scale.

The LDL Receptor Is Highly Regulated

LDL (apo B-100, E) receptors occur on the cell surface in pits that are coated on the cytosolic side of the cell membrane with a protein called

clathrin. The glycoprotein receptor spans the membrane, the B-100 binding region being at the exposed amino terminal end. After binding, LDL is taken up intact by **endocytosis**. The apoprotein and cholesteryl ester are then hydrolyzed in the lysosomes, and cholesterol is translocated into the cell. The receptors are recycled to the cell surface. This influx of cholesterol inhibits the transcription of the genes encoding HMG-CoA synthase, HMG-CoA reductase, and other enzymes involved in cholesterol synthesis, as well as the LDL receptor itself, via the SREBP pathway, and thus coordinately suppresses cholesterol synthesis and uptake. ACAT activity is also stimulated, promoting cholesterol esterification. In addition, recent research has shown that the protein **proprotein convertase subtilisin/kexin type 9 (PCSK9)** regulates the recycling of the receptor to the cell surface by targeting it for degradation. By these mechanisms, LDL receptor activity on the cell surface is regulated by the cholesterol requirement for membranes, steroid hormones, or bile acid synthesis, and the free cholesterol content of the cell is kept within relatively narrow limits (Figure 26–5).

CHOLESTEROL IS TRANSPORTED BETWEEN TISSUES IN PLASMA LIPOPROTEINS

Cholesterol is transported in plasma in lipoproteins, with the greater part in the form of cholesteryl ester (Figure 26–6), and in humans the highest proportion is found in LDL. Dietary cholesterol equilibrates with plasma cholesterol in days and with tissue cholesterol in weeks. Cholesteryl ester in the diet is hydrolyzed to cholesterol, which is then absorbed by the intestine together with dietary unesterified cholesterol and other lipids. With cholesterol synthesized in the intestines, it is then incorporated into chylomicrons (see Chapter 25). Of the cholesterol absorbed, 80 to 90% is esterified with long-chain fatty acids in the intestinal mucosa. Ninety-five percent of the chylomicron cholesterol is delivered to the liver in chylomicron remnants, and most of the cholesterol secreted by the liver in very-low-density lipoprotein (VLDL) is retained during the formation of intermediate-density lipoprotein (IDL) and ultimately LDL, which is taken up by the LDL receptor in liver and extrahepatic tissues (see Chapter 25).

lipoprotein lipase; LRP, LDL receptor–related protein-1; TG, triacylglycerol; VLDL, very-low-density lipoprotein.)

Plasma LCAT Is Responsible for Virtually All Plasma Cholesteryl Ester in Humans

Lecithin: cholesterol acyltransferase (LCAT) activity is associated with HDL containing apo A-I. As cholesterol in HDL becomes esterified, it creates a concentration gradient and draws in cholesterol from tissues and from other lipoproteins (Figures 26–5 and 26–6), thus enabling HDL to function in **reverse cholesterol transport** (see Figure 25–5).

Cholesteryl Ester Transfer Protein Facilitates Transfer of Cholesteryl Ester From HDL to Other Lipoproteins

Cholesteryl ester transfer protein, associated with HDL, is found in plasma of humans and many other species. It facilitates transfer of cholesteryl ester from HDL to VLDL, IDL, and LDL in exchange for triacylglycerol, relieving product inhibition of the LCAT activity in HDL. Thus, in humans, much of the cholesteryl ester formed by LCAT finds its way to the liver via VLDL remnants (IDL) or LDL (Figure 26–6). The triacylglycerol-enriched HDL₂ delivers its cholesterol to the liver in the HDL cycle (see Figure 25–5).

CHOLESTEROL IS EXCRETED FROM THE BODY IN THE BILE AS CHOLESTEROL OR AS BILE ACIDS (SALTS)

Cholesterol is excreted from the body via the bile either in the unesterified form or after conversion into bile acids in the liver. **Coprostanol** is the principal sterol in the feces; it is formed from cholesterol by the bacteria in the lower intestine.

Bile Acids Are Formed From Cholesterol

The primary bile acids are synthesized in the liver from cholesterol. These are **cholic acid** (found in the largest amount in most mammals) and **chenodeoxycholic acid** (Figure 26–7). The 7 α -hydroxylation of

cholesterol is the first and principal regulatory step in the biosynthesis of bile acids and is catalyzed by **cholesterol 7 α -hydroxylase**, a microsomal cytochrome P450 enzyme—designated **CYP7A1** (see [Chapter 12](#)). A typical monooxygenase, it requires oxygen, NADPH, and cytochrome P450. Subsequent hydroxylation steps are also catalyzed by monooxygenases. The pathway of bile acid biosynthesis divides early into one subpathway leading to **cholyl-CoA**, characterized by an extra α -OH group on position 12, and another pathway leading to **chenodeoxycholyl-CoA** ([Figure 26–7](#)). A second pathway in mitochondria involving the 27-hydroxylation of cholesterol by the cytochrome P450 **sterol 27-hydroxylase (CYP27A1)** as the first step is responsible for a significant proportion of the primary bile acids synthesized. The primary bile acids ([Figure 26–7](#)) enter the bile as glycine or taurine conjugates. Conjugation takes place in liver peroxisomes. In humans, the ratio of the glycine to the taurine conjugates is normally 3:1. In the alkaline bile (pH 7.6–8.4), the bile acids and their conjugates are assumed to be in a salt form—hence the term “bile salts.”

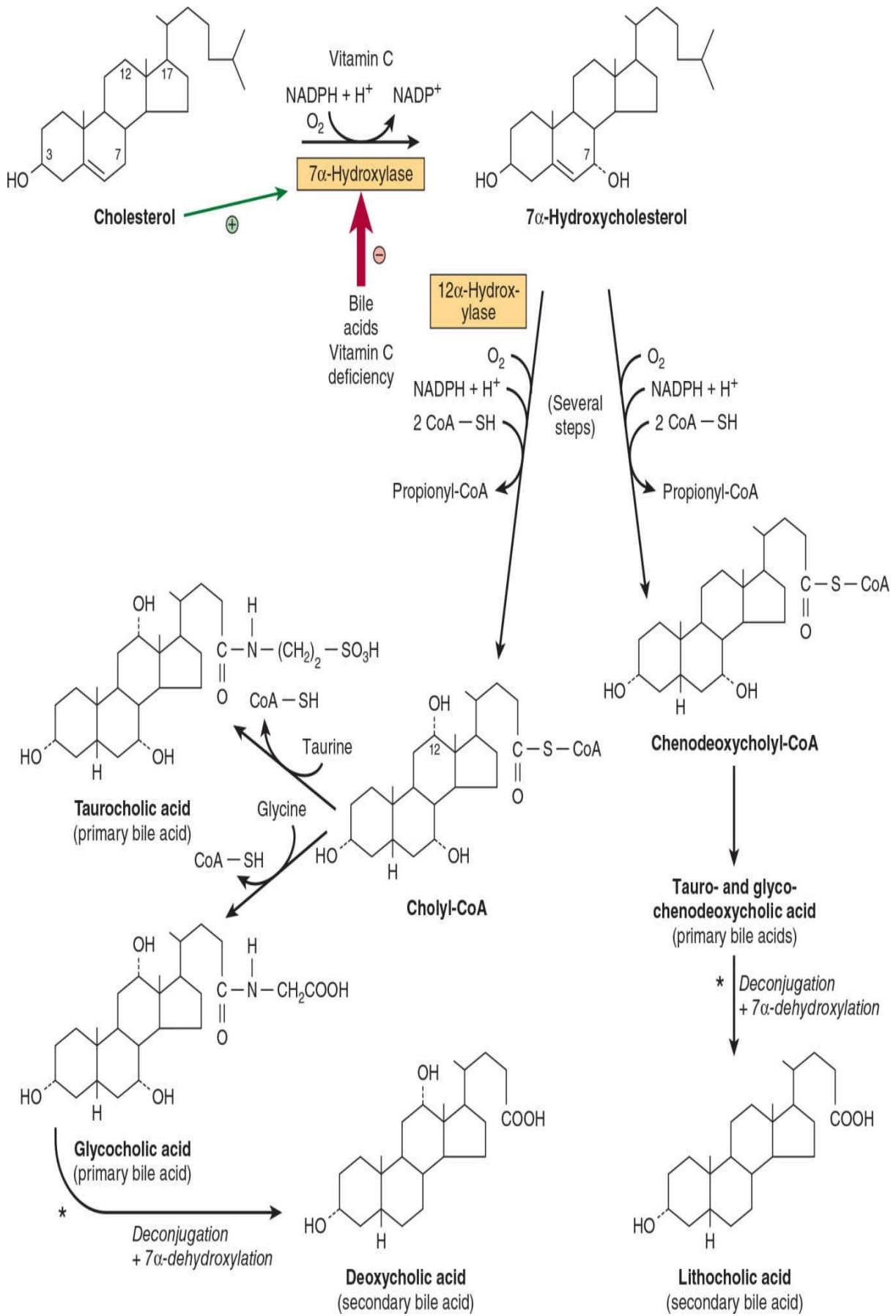

FIGURE 26–7 Biosynthesis and degradation of bile acids. A second pathway in mitochondria involves hydroxylation of cholesterol by sterol 27-hydroxylase. *Catalyzed by microbial enzymes.

Primary bile acids are further metabolized in the intestine by the activity of the intestinal bacteria. Thus, deconjugation and 7 α -dehydroxylation occur, producing the **secondary bile acids, deoxycholic acid, and lithocholic acid.**

Most Bile Acids Return to the Liver in the Enterohepatic Circulation

Although products of fat digestion, including cholesterol, are absorbed in the first 100 cm of small intestine, the primary and secondary bile acids are absorbed almost exclusively in the ileum, and 98 to 99% is returned to the liver via the portal circulation. This is known as the **enterohepatic circulation** (Figure 26–6). However, lithocholic acid, because of its insolubility, is not reabsorbed to any significant extent. Only a small fraction of the bile salts escapes absorption and is therefore eliminated in the feces. Nonetheless, this represents a major pathway for the elimination of cholesterol. Each day the pool of bile acids (about 3-5 g) is cycled through the intestine 6 to 10 times and an amount of bile acid equivalent to that lost in the feces is synthesized from cholesterol, so that a pool of bile acids of constant size is maintained. This is accomplished by a system of feedback controls.

Bile Acid Synthesis Is Regulated at the CYP7A1 Step

The principal rate-limiting step in the biosynthesis of bile acids is at the **CYP7A1 reaction** (Figure 26–7). The activity of the enzyme is feedback regulated via the nuclear bile acid-binding receptor, **farnesoid X receptor (FXR)**. When the size of the bile acid pool in the enterohepatic circulation increases, FXR is activated, and transcription of the *CYP7A1* gene is suppressed. Chenodeoxycholic acid is particularly important in activating FXR. CYP7A1 activity is also enhanced by cholesterol of endogenous and dietary origin and regulated by insulin, glucagon, glucocorticoids, and thyroid hormone.

CLINICAL ASPECTS

Serum Cholesterol Is Correlated With the Incidence of Atherosclerosis & Coronary Heart Disease

Atherosclerosis is an inflammatory disease characterized by the deposition of cholesterol and cholesteryl ester from the plasma lipoproteins into the artery wall and is a major cause of heart disease. Elevated plasma cholesterol levels (> 5.2 mmol/L) are one of the most important factors in promoting atherosclerosis, but it is now recognized that elevated blood triacylglycerol is also an independent risk factor. Diseases in which there is a prolonged elevation of levels of VLDL, IDL, chylomicron remnants, or LDL in the blood (eg, **diabetes mellitus, lipid nephrosis, hypothyroidism, and other conditions of hyperlipidemia**) are often accompanied by premature or more severe atherosclerosis. There is also an inverse relationship between HDL (HDL₂) concentrations and coronary heart disease, making the **LDL:HDL cholesterol ratio a good predictive parameter**. This is consistent with the function of HDL in reverse cholesterol transport. Susceptibility to atherosclerosis varies widely among species, and humans are one of the few in which the disease can be induced by diets high in cholesterol.

Diet Can Play an Important Role in Reducing Serum Cholesterol

Hereditary factors play the most important role in determining the serum cholesterol concentrations of individuals; however, dietary and environmental factors also play a part, and the most beneficial of these is the substitution in the diet of **polyunsaturated and monounsaturated fatty acids** for saturated fatty acids. Plant oils such as corn oil and sunflower seed oil contain a high proportion of $\omega 6$ polyunsaturated fatty acids, while olive oil contains a high concentration of monounsaturated fatty acids. $\omega 3$ fatty acids found in fish oils are also beneficial (see [Chapter 21](#)). On the other hand, butter fat, beef fat, and palm oil contain a high proportion of saturated fatty acids. Sucrose and fructose have a greater effect in raising blood lipids, particularly triacylglycerols, than do other carbohydrates.

One of the mechanisms by which unsaturated fatty acids lower blood cholesterol levels is by the upregulation of LDL receptors on the cell surface, causing an increase in the catabolic rate of LDL, the main atherogenic lipoprotein. In addition, $\omega 3$ fatty acids have anti-inflammatory and triacylglycerol-lowering effects. Saturated fatty acids also cause the

formation of smaller VLDL particles that contain relatively more cholesterol, and they are utilized by extrahepatic tissues at a slower rate than are larger particles—tendencies that may be regarded as atherogenic.

Lifestyle Affects the Serum Cholesterol Level

Additional factors considered to play a part in coronary heart disease include **high blood pressure, smoking, male gender, obesity (particularly abdominal obesity), lack of exercise, and drinking soft as opposed to hard water**. Factors associated with elevation of plasma-free fatty acids (FFAs) followed by increased output of triacylglycerol and cholesterol into the circulation in VLDL include **emotional stress and coffee drinking**. Premenopausal women appear to be protected against many of these deleterious factors, and this is thought to be related to the beneficial effects of **estrogen**. There is an association between **moderate alcohol consumption** and a lower incidence of coronary heart disease. This may be due to elevation of HDL concentrations resulting from increased synthesis of apo A-I and changes in activity of cholesteryl ester transfer protein. It has been claimed that red wine is particularly beneficial, perhaps because of its content of antioxidants. Regular exercise lowers plasma LDL but raises HDL. Triacylglycerol concentrations are also reduced, due most likely to increased insulin sensitivity, which enhances the expression of lipoprotein lipase.

When Diet Changes Fail, Hypolipidemic Drugs Can Reduce Serum Cholesterol & Triacylglycerol

A family of drugs known as **statins** have proved highly efficacious in lowering plasma cholesterol and preventing heart disease. Statins act by inhibiting HMG-CoA reductase and upregulating LDL receptor activity. Examples currently in use include **atorvastatin, simvastatin, fluvastatin, and pravastatin**. **Ezetimibe** reduces blood cholesterol levels by inhibiting the absorption of cholesterol by the intestine by blocking uptake via the **Niemann-Pick C-like 1 protein**. Other drugs used include fibrates such as **clofibrate, gemfibrozil, and nicotinic acid**, which act mainly to lower plasma triacylglycerols by decreasing the secretion of triacylglycerol and cholesterol-containing VLDL by the liver. Since PCSK9 reduces the number of LDL receptors exposed on the cell membrane, it has the effect of raising blood cholesterol levels, thus drugs that inhibit its activity are potentially antiatherogenic and two such compounds have recently been

approved for use and others are currently in clinical trials.

Primary Disorders of the Plasma Lipoproteins (Dyslipoproteinemias) Are Inherited

Inherited defects in lipoprotein metabolism lead to the primary condition of either **hypo-** or **hyperlipoproteinemia** (**Table 26–1**). For example, **familial hypercholesterolemia (FH)**, causes severe hypercholesterolemia and is also associated with premature atherosclerosis. The defect is most often in the gene for the LDL receptor, so that LDL is not cleared from the blood. In addition, diseases such as diabetes mellitus, hypothyroidism, kidney disease (nephrotic syndrome), and atherosclerosis are associated with secondary abnormal lipoprotein patterns that are very similar to one or another of the primary inherited conditions. Virtually all of the primary conditions are due to a defect at a stage in lipoprotein formation, transport, or degradation (see **Figures 25–4, 26–5, and 26–6**). Not all of the abnormalities are harmful.

TABLE 26–1 Primary Disorders of Plasma Lipoproteins (Dyslipoproteinemias)

Name	Defect	Remarks
Hypolipoproteinemias Abetalipoproteinemia	No chylomicrons, VLDL, or LDL are formed because of defect in the loading of apo B with lipid.	Rare; blood acylglycerols low; intestine and liver accumulate acylglycerols. Intestinal malabsorption. Early death avoidable by administration of large doses of fat-soluble vitamins, particularly vitamin E.
Familial α -lipoprotein deficiency Tangier disease Fish-eye disease Apo A-I deficiencies	All have low or near absence of HDL.	Tendency toward hypertriacylglycerolemia as a result of absence of apo C-II, causing inactive LPL. Low LDL levels. Atherosclerosis in the elderly.
Hyperlipoproteinemias Familial lipoprotein lipase deficiency (type I)	Hypertriacylglycerolemia due to deficiency of LPL, abnormal LPL, or apo C-II deficiency causing inactive LPL.	Slow clearance of chylomicrons and VLDL. Low levels of LDL and HDL. No increased risk of coronary disease.
Familial hypercholesterolemia (type IIa)	Defective LDL receptors or mutation in ligand region of apo B-100.	Elevated LDL levels and hypercholesterolemia, resulting in atherosclerosis and coronary disease.
Familial type III hyperlipoproteinemia (broad β -disease, remnant removal disease, familial dysbetalipoproteinemia)	Deficiency in remnant clearance by the liver is due to abnormality in apo E. Patients lack isoforms E3 and E4 and have only E2, which does not react with the E receptor.*	Increase in chylomicron and VLDL remnants of density <1.019 (β -VLDL). Causes hypercholesterolemia, xanthomas, and atherosclerosis.
Familial hypertriacylglycerolemia (type IV)	Overproduction of VLDL often associated with glucose intolerance and hyperinsulinemia.	Cholesterol levels rise with the VLDL concentration. LDL and HDL tend to be subnormal. This type of pattern is commonly associated with coronary heart disease, type 2 diabetes mellitus, obesity, alcoholism, and administration of progestational hormones.
Familial hyperalphalipoproteinemia	Increased concentrations of HDL.	A rare condition apparently beneficial to health and longevity.
Hepatic lipase deficiency	Deficiency of the enzyme leads to accumulation of large triacylglycerol-rich HDL and VLDL remnants.	Patients have xanthomas and coronary heart disease.
Familial lecithin:cholesterol acyltransferase (LCAT) deficiency	Absence of LCAT leads to block in reverse cholesterol transport. HDL remains as nascent disks incapable of taking up and esterifying cholesterol.	Plasma concentrations of cholesteryl esters and lysolecithin are low. Present in an abnormal LDL fraction, lipoprotein X, found also in patients with cholestasis. VLDL is abnormal (β -VLDL).
Familial lipoprotein(a) excess	Lp(a) consists of 1 mol of LDL attached to 1 mol of apo(a). Apo(a) shows structural homologies to plasminogen.	Premature coronary heart disease due to atherosclerosis, plus thrombosis due to inhibition of fibrinolysis.

*There is an association between patients possessing the apo E4 allele and the incidence of Alzheimer disease. Apparently, apo E4 binds more avidly to β -amyloid found in neuritic plaques.

Abbreviations: LDL, low-density lipoprotein; LPL, lipoprotein lipase; HDL, high-density lipoprotein; VLDL, very-low-density lipoprotein.

SUMMARY

- Cholesterol is the precursor of all other steroids in the body, for example, corticosteroids, sex hormones, bile acids, and vitamin D. It also plays an important structural role in membranes and in the outer layer of lipoproteins.
- Cholesterol is synthesized in the body entirely from acetyl-CoA. Three molecules of acetyl-CoA form mevalonate via the important regulatory reaction for the pathway, catalyzed by HMG-CoA reductase. Next, a five-carbon isoprenoid unit is formed, and six of these condense to form squalene. Squalene undergoes cyclization to form the parent steroid lanosterol, which, after the loss of three methyl groups and other changes, forms cholesterol.
- Cholesterol synthesis in the liver is regulated partly by cholesterol in the diet. In tissues, cholesterol balance is maintained between the factors causing gain of cholesterol (eg, synthesis, uptake via the LDL or scavenger receptors) and the factors causing loss of cholesterol (eg, steroid synthesis, cholesteryl ester formation, excretion). The activity of the LDL receptor is modulated by cellular cholesterol levels to achieve this balance. In reverse cholesterol transport, HDL takes up cholesterol from the tissues and LCAT esterifies it and deposits it in the core of the particles. The cholesteryl ester in HDL is taken up by the liver, either directly or after transfer to VLDL, IDL, or LDL via the cholesteryl ester transfer protein.
- Excess cholesterol is excreted from the liver in the bile as cholesterol or bile salts. A large proportion of bile salts is absorbed into the portal circulation and returned to the liver as part of the enterohepatic circulation.
- Elevated levels of cholesterol present in VLDL, IDL, or LDL are associated with atherosclerosis, whereas high levels of HDL have a protective effect.
- Inherited defects in lipoprotein metabolism lead to a primary condition of hypo- or hyperlipoproteinemia. Conditions such as diabetes mellitus, hypothyroidism, kidney disease, and atherosclerosis exhibit secondary abnormal lipoprotein patterns that resemble certain primary conditions.

REFERENCES

- Brown AJ, Sharpe LJ: Cholesterol synthesis. In *Biochemistry of Lipids, Lipoproteins and Membranes*, 6th ed. Ridgway N, McLeod R (editors). Academic Press, 2015:328-358.
- Dawson PA: Bile acid metabolism. In *Biochemistry of Lipids, Lipoproteins and Membranes*, 6th ed. Ridgway N, McLeod R (editors). Academic Press, 2015:359-390.
- Francis G: High density lipoproteins: metabolism and protective roles against atherosclerosis. In *Biochemistry of Lipids, Lipoproteins and Membranes*, 6th ed. Ridgway N, McLeod R (editors). Academic Press, 2015:437-459.

Exam Questions

Section V – Metabolism of Lipids

1. Which one of the following statements concerning fatty acid molecules is CORRECT?
 - A. They consist of a carboxylic acid head group attached to a carbohydrate chain.
 - B. They are called polyunsaturated when they contain one or more carbon–carbon double bonds.
 - C. Their melting points increase with increasing unsaturation.
 - D. They almost always have their double bonds in the *cis* configuration when they occur naturally.
 - E. They occur in the body mainly in the form of free (nonesterified) fatty acids.
2. Which one of the following is NOT a phospholipid?
 - A. Sphingomyelin
 - B. Plasmalogen
 - C. Cardiolipin
 - D. Galactosylceramide
 - E. Lysolecithin

3. Which one of the following statements about gangliosides is INCORRECT?
- A. They are derived from galactosylceramide.
 - B. They contain one or more molecules of sialic acid.
 - C. They are present in nervous tissue in high concentrations.
 - D. The ganglioside GM1 is the receptor for cholera toxin in the human intestine.
 - E. They function in cell–cell recognition.
4. Which one of the following is a chain-breaking antioxidant?
- A. Glutathione peroxidase
 - B. Selenium
 - C. Superoxide dismutase
 - D. EDTA
 - E. Catalase
5. After they are produced from acetyl-CoA in the liver, ketone bodies are mainly used for which one of the following processes?
- A. Excretion as waste products
 - B. Energy generation in the liver
 - C. Conversion to fatty acids for storage of energy
 - D. Generation of energy in the tissues
 - E. Generation of energy in red blood cells
6. The subcellular site of the breakdown of long-chain fatty acids to acetyl-CoA via β -oxidation is:
- A. The cytosol
 - B. The matrix of the mitochondria
 - C. The endoplasmic reticulum
 - D. The mitochondrial intermembrane space
 - E. The Golgi apparatus
7. Carnitine is needed for fatty acid oxidation BECAUSE:
- A. It is a cofactor for acyl-CoA synthetase, which activates fatty acids for breakdown.
 - B. Long-chain acyl-CoA (“activated fatty acids”) need to enter the mitochondrial matrix to be oxidized, but cannot cross the outer

- mitochondrial membrane. Transfer of the acyl group from CoA to carnitine enables translocation to occur.
- C. Acylcarnitine, formed when long-chain acyl groups are transferred from CoA to carnitine is the substrate for the first step in the β -oxidation pathway.
 - D. Long-chain acyl-CoA (“activated fatty acids”) need to enter the mitochondrial intermembrane space to be oxidized, but cannot cross the inner mitochondrial membrane. Transfer of the acyl group from CoA to carnitine enables translocation to occur.
 - E. It prevents the breakdown of long-chain fatty acyl-CoA in the mitochondrial intermembrane space.
8. The breakdown of one molecule of a C16 fully saturated fatty acid (palmitic acid) by β -oxidation lead to the formation of:
- A. 8 FADH₂, 8 NADH, and 8 acetyl-CoA molecules
 - B. 7 FADH₂, 7 NADH, and 7 acetyl-CoA molecules
 - C. 8 FADH₂, 8 NADH, and 7 acetyl-CoA molecules
 - D. 7 FADH₂, 8 NADH, and 8 acetyl-CoA molecules
 - E. 7 FADH₂, 7 NADH, and 8 acetyl-CoA molecules
9. Malonyl-CoA, the first intermediate in fatty acid synthesis, is an important regulator of fatty acid metabolism BECAUSE:
- A. Its formation from acetyl-CoA and bicarbonate by the enzyme acetyl-CoA carboxylase is the main rate-limiting step in fatty acid synthesis.
 - B. It prevents entry of fatty acyl groups into the matrix of the mitochondria because it is a potent inhibitor of carnitine palmitoyl transferase-I.
 - C. It prevents entry of fatty acyl groups into the matrix of the mitochondria because it is a potent inhibitor of carnitine palmitoyl transferase-II.
 - D. It prevents entry of fatty acyl groups into the matrix of the mitochondria because it is a potent inhibitor of carnitine–acylcarnitine translocase.
 - E. It inhibits the synthesis of fatty acyl-CoA.
10. α -Linolenic acid is considered to be nutritionally essential in humans

BECAUSE:

- A. It is an ω 3 fatty acid.
 - B. It contains three double bonds.
 - C. In humans, double bonds cannot be introduced into fatty acids beyond the Δ 9 position.
 - D. In humans, double bonds cannot be introduced into fatty acids beyond the Δ 12 position.
 - E. Human tissues are unable to introduce a double bond in the Δ 9 position of fatty acids.
11. Inactivation of acetyl-CoA carboxylase is favored WHEN:
- A. Cytosolic citrate levels are high.
 - B. It is in a polymeric form.
 - C. Palmitoyl-CoA levels are low.
 - D. The tricarboxylate transporter is inhibited.
 - E. It is dephosphorylated.
12. Which one of the following eicosanoids is synthesized from linoleic acid via the cyclooxygenase pathway?
- A. Prostaglandin E₁ (PGE₁)
 - B. Leukotriene A₃ (LTA₃)
 - C. Prostaglandin E₃ (PGE₃)
 - D. Lipoxin A₄ (LXA₄)
 - E. Thromboxane A₃ (TXA₃)
13. Which one of the following enzymes is inhibited by the nonsteroidal anti-inflammatory drug (NSAID) aspirin?
- A. Lipoxygenase
 - B. Prostacyclin synthase
 - C. Cyclooxygenase
 - D. Thromboxane synthase
 - E. Δ 6 desaturase
14. Which one of the following is the major product of fatty acid synthase?
- A. Acetyl-CoA

- B. Oleate
 - C. Palmitoyl-CoA
 - D. Acetoacetate
 - E. Palmitate
15. Fatty acids are broken down by repeated removal of two carbon fragments as acetyl-CoA in the β -oxidation cycle, and synthesized by repeated condensation of acetyl-CoAs until a long-chain saturated fatty acid with an even number of carbons is formed. Since fatty acids need to be broken down when energy is short supply and synthesized when it is plentiful, there are important differences between the two processes which help cells to regulate them efficiently. Which one of the following statements concerning these differences is INCORRECT?
- A. Fatty acid breakdown takes place inside mitochondria, while synthesis occurs in the cytosol.
 - B. Fatty acid breakdown uses NAD^+ and produces NADH, while synthesis uses NADPH and produces NADP.
 - C. Fatty acyl groups are activated for breakdown using CoA and for synthesis using acyl carrier protein.
 - D. Transport across the mitochondrial membrane of fatty acyl groups is required for fatty acid breakdown, but not for synthesis.
 - E. Glucagon promotes fatty acid synthesis and inhibits fatty acid breakdown.
16. Hormone-sensitive lipase, the enzyme which mobilizes fatty acids from triacylglycerol stores in adipose tissue is inhibited by:
- A. Glucagon
 - B. ACTH
 - C. Epinephrine
 - D. Vasopressin
 - E. Prostaglandin E
17. Which one of the following best describes the action of phospholipase C?
- A. It releases the fatty acyl chain from the *sn*-2 position of a phospholipid.
 - B. It cleaves a phospholipid into its phosphate-containing head group

- and a diacylglycerol.
- C. It releases the head group of a phospholipid, leaving phosphatidic acid.
 - D. It releases the fatty acyl chain from the *sn*-1 position of a phospholipid.
 - E. It releases the fatty acyl chains from the *sn*-1 and *sn*-2 positions of a phospholipid.
18. Tay-Sachs disease is a lipid storage disease caused by a genetic defect in which one of the following enzymes:
- A. β -Galactosidase
 - B. Sphingomyelinase
 - C. Ceramidase
 - D. Hexosaminidase A
 - E. β -Glucosidase
19. Which of the plasma lipoproteins is best described as follows: synthesized in the intestinal mucosa, contains a high concentration of triacylglycerol, and is responsible for the transport of dietary lipids in the circulation?
- A. Chylomicrons
 - B. High-density lipoprotein
 - C. Intermediate-density lipoprotein
 - D. Low-density lipoprotein
 - E. Very-low-density lipoprotein
20. Which of the plasma lipoproteins is best described as follows: synthesized in the liver, contains a high concentration of triacylglycerol, and is mainly cleared from the circulation by adipose tissue and muscle?
- A. Chylomicrons
 - B. High-density lipoprotein
 - C. Intermediate-density lipoprotein
 - D. Low-density lipoprotein
 - E. Very-low-density lipoprotein
21. Which of the plasma lipoproteins is best described as follows: formed

in the circulation by removal of triacylglycerol from very-low-density lipoprotein, contains apo B-100, delivers cholesterol to extrahepatic tissues?

- A. Chylomicrons
 - B. High-density lipoprotein
 - C. Intermediate-density lipoprotein
 - D. Low-density lipoprotein
 - E. Very-low-density lipoprotein
22. Which of the following will be elevated in the bloodstream about 2 hours after eating a high-fat meal?
- A. Chylomicrons
 - B. High-density lipoprotein
 - C. Ketone bodies
 - D. Nonesterified fatty acids
 - E. Very-low-density lipoprotein
23. Which of the following will be elevated in the bloodstream about 4 hours after eating a high-fat meal?
- A. Low-density lipoprotein
 - B. High-density lipoprotein
 - C. Ketone bodies
 - D. Nonesterified fatty acids
 - E. Very-low-density lipoprotein
24. Which one of the following processes is NOT involved in the transfer of cholesterol from extrahepatic tissues and its delivery to the liver for excretion by HDL?
- A. Efflux of cholesterol from tissues to pre β -HDL via ABCA1.
 - B. Esterification of cholesterol to cholesteryl ester by LCAT to form HDL₃.
 - C. Transfer of cholesteryl ester from HDL to VLDL, IDL, and LDL by the action of cholesteryl ester transfer protein (CETP).
 - D. Efflux of cholesterol from tissues to HDL₃ via SR-B1 and ABCG1.
 - E. Selective uptake of cholesteryl ester from HDL₂ by the liver via

SR-B1.

25. Which one of the following statements concerning chylomicrons is CORRECT?
- A. Chylomicrons are made inside intestinal cells and secreted into lymph, where they acquire apolipoproteins B and C.
 - B. The core of chylomicrons contains triacylglycerol and phospholipids.
 - C. The enzyme hormone-sensitive lipase acts on chylomicrons to release fatty acids from triacylglycerol when they are bound to the surface of endothelial cells in blood capillaries.
 - D. Chylomicron remnants differ from chylomicrons in that they are smaller and contain a lower proportion of triacylglycerol and a higher proportion of cholesterol.
 - E. Chylomicrons are taken up by the liver.
26. Which one of the following statements concerning the biosynthesis of cholesterol is CORRECT?
- A. The rate-limiting step is the formation of 3-hydroxy-3-methylglutaryl-CoA (HMG-CoA) by the enzyme HMG-CoA synthase.
 - B. Synthesis occurs in the cytosol of the cell.
 - C. All the carbon atoms in the cholesterol synthesized originate from acetyl-CoA.
 - D. Squalene is the first cyclic intermediate in the pathway.
 - E. The initial substrate is mevalonate.
27. The class of drugs called statins have proved very effective against hypercholesterolemia, a major cause of atherosclerosis and associated cardiovascular disease. These drugs reduce plasma cholesterol levels by:
- A. Preventing absorption of cholesterol from the intestine.
 - B. Increasing the excretion of cholesterol from the body via conversion to bile acids.
 - C. Inhibiting the conversion of 3-hydroxy-3-methylglutaryl-CoA to mevalonate in the pathway for cholesterol biosynthesis.
 - D. Increasing the rate of degradation of 3-hydroxy-3-methylglutaryl-CoA reductase.

- E. Stimulating the activity of the LDL receptor in the liver.
28. Which of the following statements about bile acids (or bile salts) is INCORRECT?
- A. Primary bile acids are synthesized in the liver from cholesterol.
 - B. Bile acids are needed for the breakdown of fats by pancreatic lipase.
 - C. Secondary bile acids are produced by modification of primary bile acids in the liver.
 - D. Bile acids facilitate the absorption of the products of lipid digestion in the jejunum.
 - E. Bile acids are recirculated between the liver and the small intestine in the enterohepatic circulation.
29. A 35-year-old man with severe hypercholesterolemia has a family history of deaths at a young age from heart disease and stroke. Which of the following genes is likely to be defective?
- A. Apolipoprotein E
 - B. The LDL receptor
 - C. Lipoprotein lipase
 - D. *PCSK9*
 - E. *LCAT*
30. The recently discovered protein, proprotein convertase subtilisin/kexin type 9 (*PCSK9*), has been identified as a potential target for antiatherogenic drugs BECAUSE:
- A. It decreases the number of LDL receptors exposed at the cell surface, thus LDL uptake is lowered and blood cholesterol levels rise.
 - B. It inhibits the binding of apo B to the LDL receptor, thus blocking uptake of the lipoprotein and raising blood cholesterol levels.
 - C. It increases the absorption of cholesterol from the intestine.
 - D. It prevents the breakdown of cholesterol to bile acids in the liver.
 - E. It increases the synthesis and secretion of VLDL in the liver, leading to increased LDL formation in the blood.

SECTION

VI

Metabolism of Proteins & Amino Acids

CHAPTER

27

Biosynthesis of the Nutritionally Nonessential Amino Acids

Victor W. Rodwell, PhD

OBJECTIVES

After studying this chapter, you should be able to:

- Explain why the absence from the diet of certain amino acids that are present in most proteins is not deleterious to human health.
- Appreciate the distinction between the terms “essential” and “nutritionally essential” amino acids, and identify the amino acids that are nutritionally nonessential.
- Name the intermediates of the citric acid cycle and of glycolysis that are precursors of aspartate, asparagine, glutamate, glutamine,

glycine, and serine.

- Illustrate the key role of transaminases in amino acid metabolism.
- Explain the process by which the 4-hydroxyproline and 5-hydroxylysine of proteins such as collagen are formed.
- Describe the clinical presentation of scurvy, and provide a biochemical explanation for why a severe deprivation of vitamin C (ascorbic acid) results in this nutritional disorder.
- Appreciate that, despite the toxicity of selenium, selenocysteine is an essential component of several mammalian proteins.
- Define and outline the reaction catalyzed by a mixed-function oxidase.
- Identify the role of tetrahydrobiopterin in tyrosine biosynthesis.
- Indicate the role of a modified transfer RNA (tRNA) in the cotranslational insertion of selenocysteine into proteins.

BIOMEDICAL IMPORTANCE

Amino acid deficiency states can result if nutritionally essential amino acids are absent from the diet, or are present in inadequate amounts. Examples in certain regions of West Africa include **kwashiorkor**, which results when a child is weaned onto a starchy diet poor in protein, and **marasmus**, in which both caloric intake and specific amino acids are deficient. Patients with short bowel syndrome unable to absorb sufficient quantities of calories and nutrients suffer from significant nutritional and metabolic abnormalities. Both the nutritional disorder **scurvy**, a dietary deficiency of vitamin C, and specific genetic disorders are associated with an impaired ability of connective tissue to form peptidyl 4-hydroxyproline and peptidyl 5-hydroxylysine. The resulting conformational instability of collagen is accompanied by bleeding gums, swelling joints, poor wound healing, and ultimately in death. **Menkes syndrome**, characterized by kinky hair and growth retardation, results from a dietary deficiency of copper, an essential cofactor for the enzyme lysyl oxidase that functions in formation of the covalent cross-links that strengthen collagen fibers. Genetic disorders of collagen biosynthesis include several forms of **osteogenesis imperfecta**, characterized by fragile bones, and **Ehlers-Danlos syndrome**, a group of connective tissue disorders that result in mobile joints and skin abnormalities due to defects in the genes that encode enzymes, including procollagen-lysine 5-hydroxylase.

NUTRITIONALLY ESSENTIAL & NUTRITIONALLY NONESSENTIAL AMINO ACIDS

While often employed with reference to amino acids, the terms “essential” and “nonessential” are misleading since all 20 common amino acids are essential to ensure health. Of these 20 amino acids, 8 *must* be present in the human diet, and thus are best termed “*nutritionally essential*.” The other 12 amino acids are “*nutritionally nonessential*” since they need not be present in the diet (**Table 27–1**). The distinction between these two classes of amino acids was established in the 1930s by feeding human subjects purified amino acids in place of protein. Subsequent biochemical investigations revealed the reactions and intermediates involved in the biosynthesis of all 20 amino acids. Amino acid deficiency disorders are endemic in certain regions of West Africa where diets rely heavily on grains that are poor sources of tryptophan and lysine. These nutritional disorders include **kwashiorkor**, which results when a child is weaned onto a starchy diet poor in protein, and **marasmus**, in which both caloric intake and specific amino acids are deficient.

TABLE 27–1 Amino Acid Requirements of Humans

Nutritionally Essential	Nutritionally Nonessential
Arginine ^a	Alanine
Histidine	Asparagine
Isoleucine	Aspartate
Leucine	Cysteine
Lysine	Glutamate
Methionine	Glutamine
Phenylalanine	Glycine
Threonine	Hydroxyproline ^b
Tryptophan	Hydroxylysine ^b
Valine	Proline
	Serine
	Tyrosine

^aNutritionally “semiessential.” Synthesized at rates inadequate to support growth of children.

^bNot necessary for protein synthesis, but is formed during posttranslational processing of collagen.

Lengthy Metabolic Pathways Form the Nutritionally Essential Amino Acids

The existence of nutritional requirements suggests that dependence on an external supply of a given nutrient can be of greater survival value than the ability to biosynthesize it. Why? If a specific nutrient is present in the food, an organism that can synthesize it will transfer to its progeny genetic information of *negative* survival value. The survival value is negative rather than nil because ATP and nutrients are required to synthesize “unnecessary” DNA—even if specific encoded genes are no longer expressed. The number of enzymes required by prokaryotic cells to synthesize the nutritionally essential amino acids is large relative to the number of enzymes required to synthesize the nutritionally nonessential amino acids (**Table 27–2**). This suggests a survival advantage in retaining the ability to manufacture “easy” amino acids while losing the ability to make “difficult” amino acids. The metabolic pathways that form the

nutritionally essential amino acids occur in plants and bacteria, but not in humans, and thus are not discussed. This chapter addresses the reactions and intermediates involved in the biosynthesis by human tissues of the 12 nutritionally *nonessential* amino acids and selected nutritional and metabolic disorders associated with their metabolism.

TABLE 27–2 Enzymes Required for the Synthesis of Amino Acids From Amphibolic Intermediates

Number of Enzymes Required to Synthesize			
Nutritionally Essential		Nutritionally Nonessential	
Arg ^a	7	Ala	1
His	6	Asp	1
Thr	6	Asn ^b	1
Met	5 (4 shared)	Glu	1
Lys	8	Gln ^a	1
Ile	8 (6 shared)	Hyl ^c	1
Val	6 (all shared)	Hyp ^d	1
Leu	7 (5 shared)	Pro ^a	3
Phe	10	Ser	3
Trp	5 (8 shared)	Gly ^e	1
	59 (total)	Cys ^f	2
		Tyr ^g	1
			17 (total)

^aFrom Glu.

^bFrom Asp.

^cFrom Lys.

^dFrom Pro.

^eFrom Ser.

^fFrom Ser plus sulfate.

^gFrom Phe.

BIOSYNTHESIS OF THE NUTRITIONALLY NONESSENTIAL AMINO ACIDS

Glutamate

Glutamate, the precursor of the so-called “glutamate family” of amino acids, is formed by the reductive amidation of the citric acid cycle α -ketoglutarate, a reaction catalyzed by mitochondrial glutamate dehydrogenase (**Figure 27–1**). The reaction strongly favors glutamate synthesis, which lowers the concentration of cytotoxic ammonium ion.

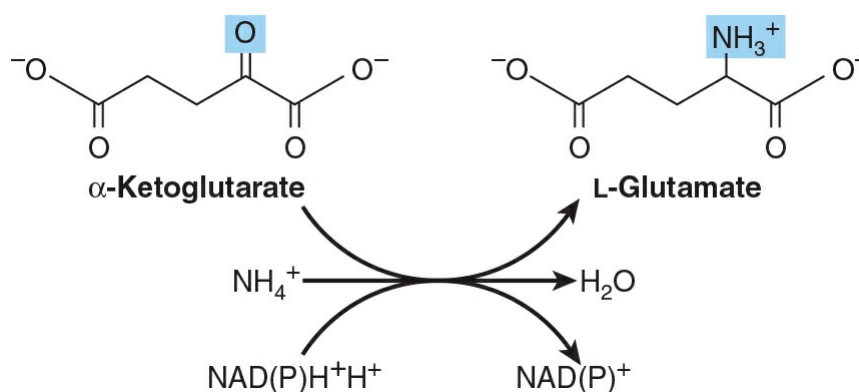

FIGURE 27–1 The reaction catalyzed by glutamate dehydrogenase (EC 1.4.1.3).

Glutamine

The amidation of glutamate to glutamine catalyzed by glutamine synthetase (**Figure 27–2**) involves the intermediate formation of γ -glutamyl phosphate (**Figure 27–3**). Following the ordered binding of glutamate and ATP, glutamate attacks the γ -phosphorus of ATP, forming γ -glutamyl phosphate and ADP. NH_4^+ then binds, and uncharged NH_3 attacks γ -glutamyl phosphate. Release of P_i and of a proton from the γ -amino group of the tetrahedral intermediate then allows release of the product, glutamine.

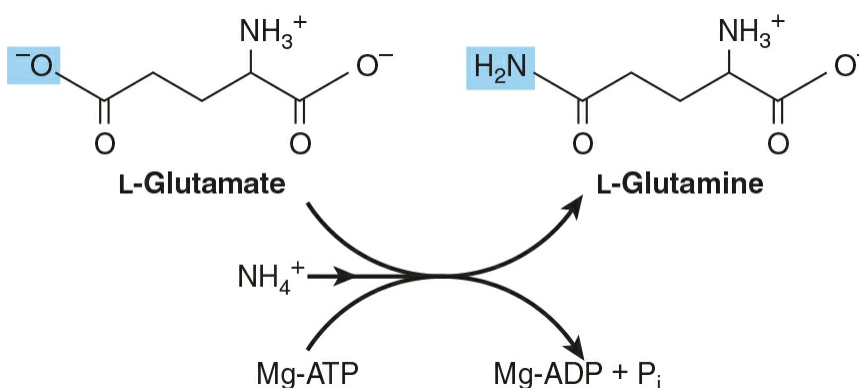

FIGURE 27–2 The reaction catalyzed by glutamine synthetase (EC 6.3.1.2).

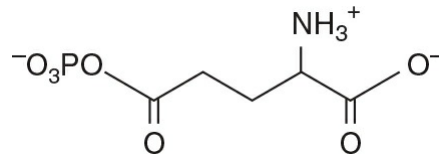

FIGURE 27–3 γ -Glutamyl phosphate.

Alanine & Aspartate

Transamination of pyruvate forms alanine (Figure 27–4). Similarly, transamination of oxaloacetate forms aspartate.

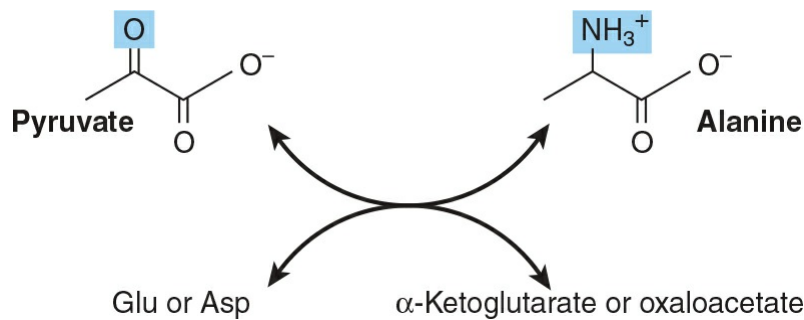

FIGURE 27–4 Formation of alanine by transamination of pyruvate. The amino donor may be glutamate or aspartate. The other product thus is α -ketoglutarate or oxaloacetate.

Glutamate Dehydrogenase, Glutamine Synthetase, & Aminotransferases Play Central Roles in Amino Acid Biosynthesis

The combined action of the enzymes glutamate dehydrogenase, glutamine synthetase, and the aminotransferases (Figures 27–1, 27–2 and 27–4) results in conversion of inorganic ammonium ion into the α -amino nitrogen of amino acids.

Asparagine

The conversion of aspartate to asparagine, catalyzed by asparagine synthetase (Figure 27–5), resembles the glutamine synthetase reaction (Figure 27–2), but glutamine, rather than ammonium ion, provides the nitrogen. Bacterial asparagine synthetases can, however, also use

ammonium ion. The reaction involves the intermediate formation of aspartyl phosphate (**Figure 27-6**). The coupled hydrolysis of PP_i to P_i by pyrophosphatase, EC 3.6.1.1, ensures that the reaction is strongly favored.

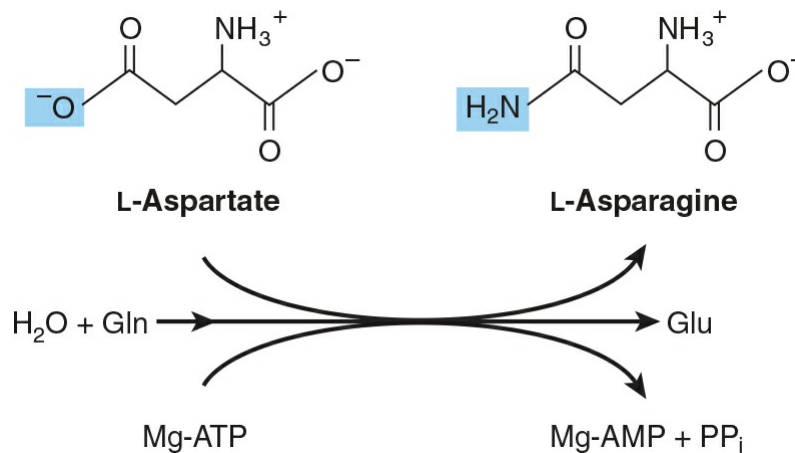

FIGURE 27-5 The reaction catalyzed by asparagine synthetase (EC 6.3.5.4). Note similarities to and differences from the glutamine synthetase reaction (**Figure 27-2**).

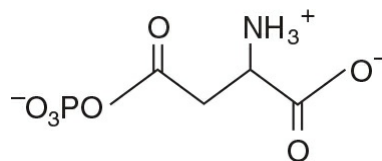

FIGURE 27-6 Aspartyl phosphate.

Serine

Oxidation of the α -hydroxyl group of the glycolytic intermediate 3-phosphoglycerate, catalyzed by 3-phosphoglycerate dehydrogenase, converts it to 3-phosphohydroxypyruvate. Transamination and subsequent dephosphorylation then form serine (**Figure 27-7**).

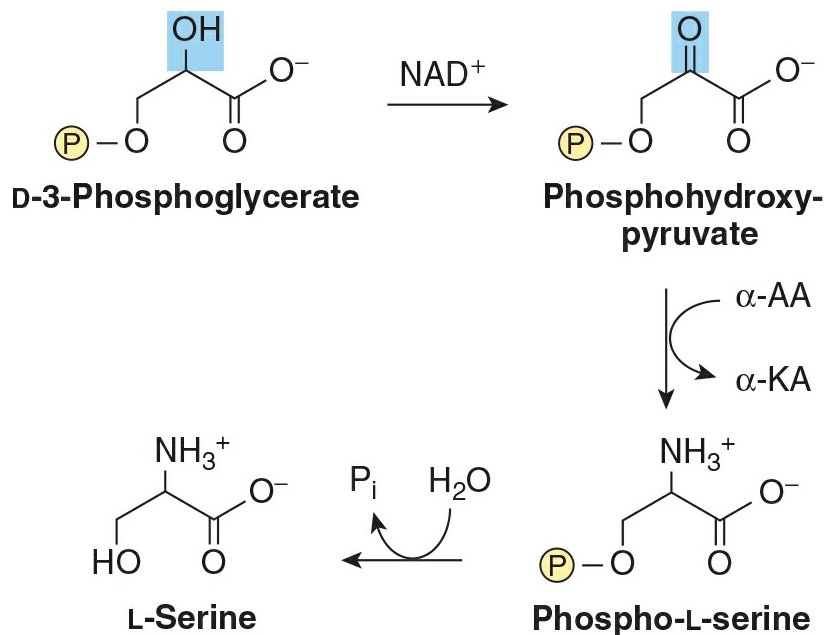

FIGURE 27–7 Serine biosynthesis. Oxidation of 3-phosphoglycerate is catalyzed by 3-phosphoglycerate dehydrogenase (EC 1.1.1.95). Transamination converts phosphohydroxypyruvate to phosphoserine. Hydrolytic removal of the phosphoryl group catalyzed by phosphoserine hydrolase (EC 3.1.3.3) then forms L-serine.

Glycine

Glycine aminotransferases can catalyze the synthesis of glycine from glyoxylate and glutamate or alanine. Unlike most aminotransferase reactions, these strongly favor glycine synthesis. Additional important mammalian routes for glycine formation are from choline (**Figure 27–8**) and from serine (**Figure 27–9**).

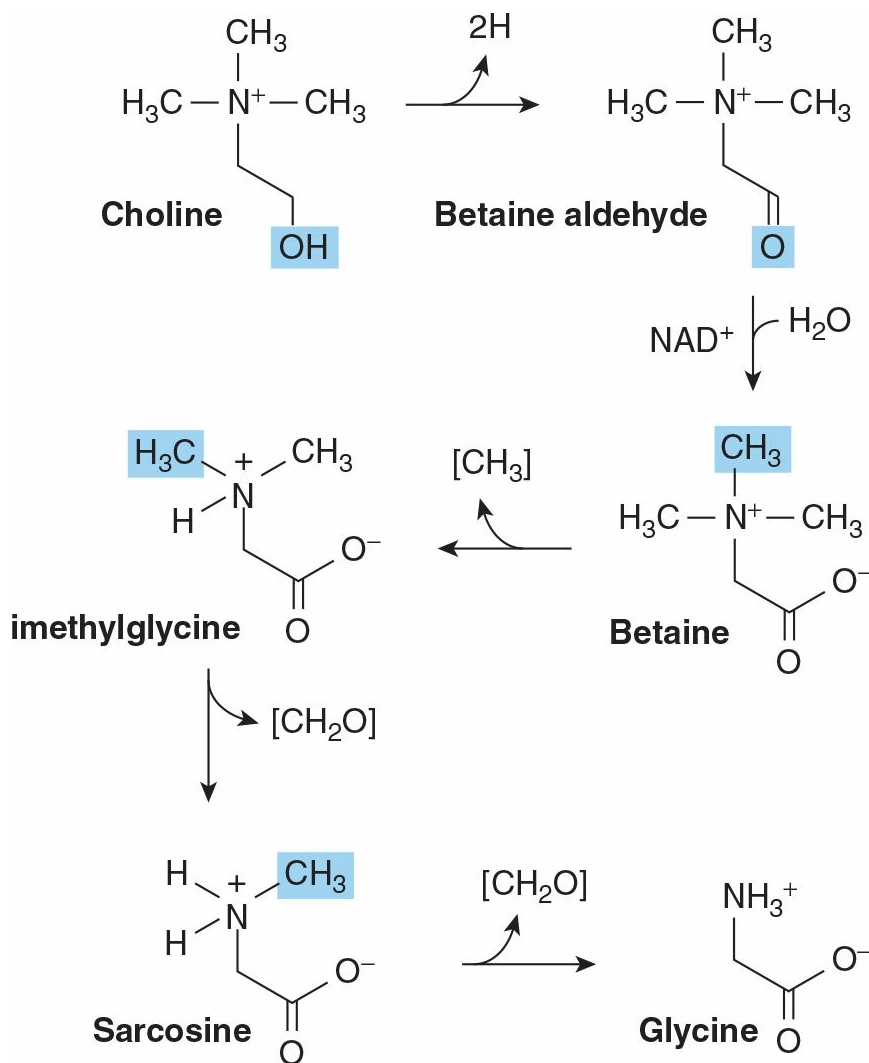

FIGURE 27–8 Formation of glycine from choline. Catalysts include choline dehydrogenase (EC 1.1.3.17), betaine aldehyde dehydrogenase (EC 1.2.1.8), betaine-homocysteine *N*-methyltransferase (EC 2.1.1.157), sarcosine dehydrogenase (EC 1.5.8.3), and dimethylglycine dehydrogenase (EC 1.5.8.4).

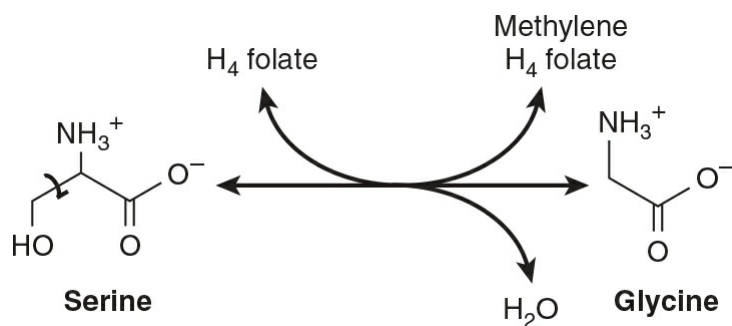

FIGURE 27–9 Interconversion of serine and glycine, catalyzed by serine hydroxymethyltransferase (EC 2.1.2.1). The reaction is freely reversible. (H_4 folate, tetrahydrofolate.)

Proline

The initial reaction of proline biosynthesis converts the γ -carboxyl group of glutamate to the mixed acid anhydride of glutamate γ -phosphate (Figure 27-3). Subsequent reduction forms glutamate γ -semialdehyde, which following spontaneous cyclization is reduced to L-proline (Figure 27-10).

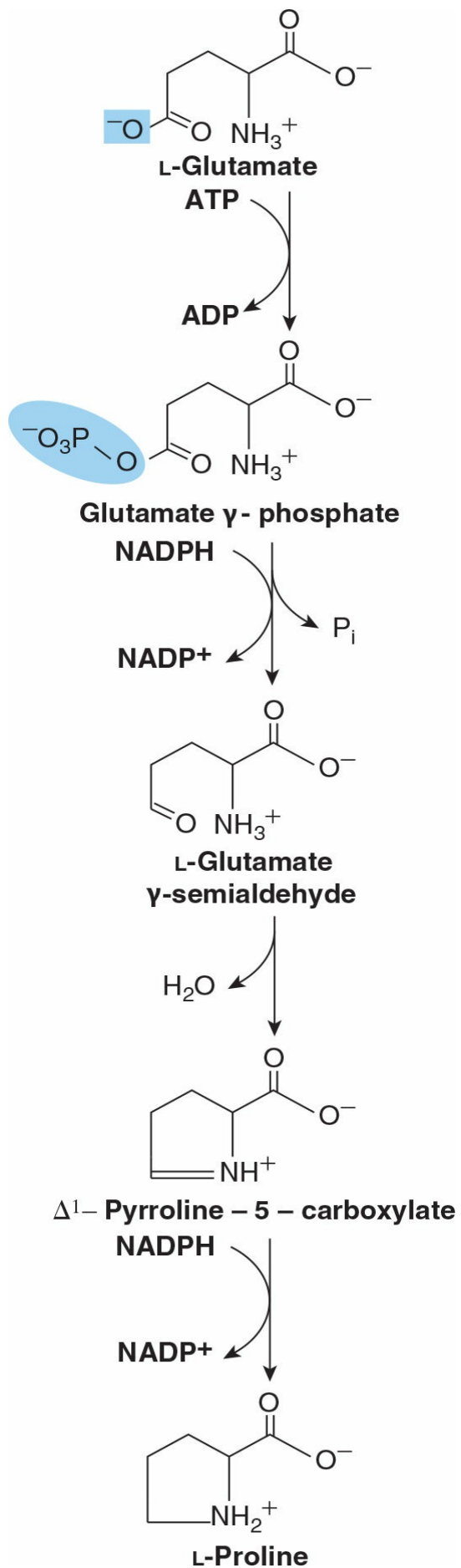

FIGURE 27–10 Biosynthesis of proline from glutamate. Catalysts for these reactions are glutamate-5-kinase (EC 2.7.2.11), glutamate-5-semialdehyde dehydrogenase (EC 1.2.1.41), and pyrroline-5-carboxylate reductase (EC 1.5.1.2). Ring closure of glutamate semialdehyde is spontaneous.

Cysteine

While not nutritionally essential, cysteine is formed from methionine, which is nutritionally essential. Following conversion of methionine to homocysteine (see [Figure 29–18](#)), homocysteine and serine form cystathionine, whose hydrolysis forms cysteine and homoserine ([Figure 27–11](#)).

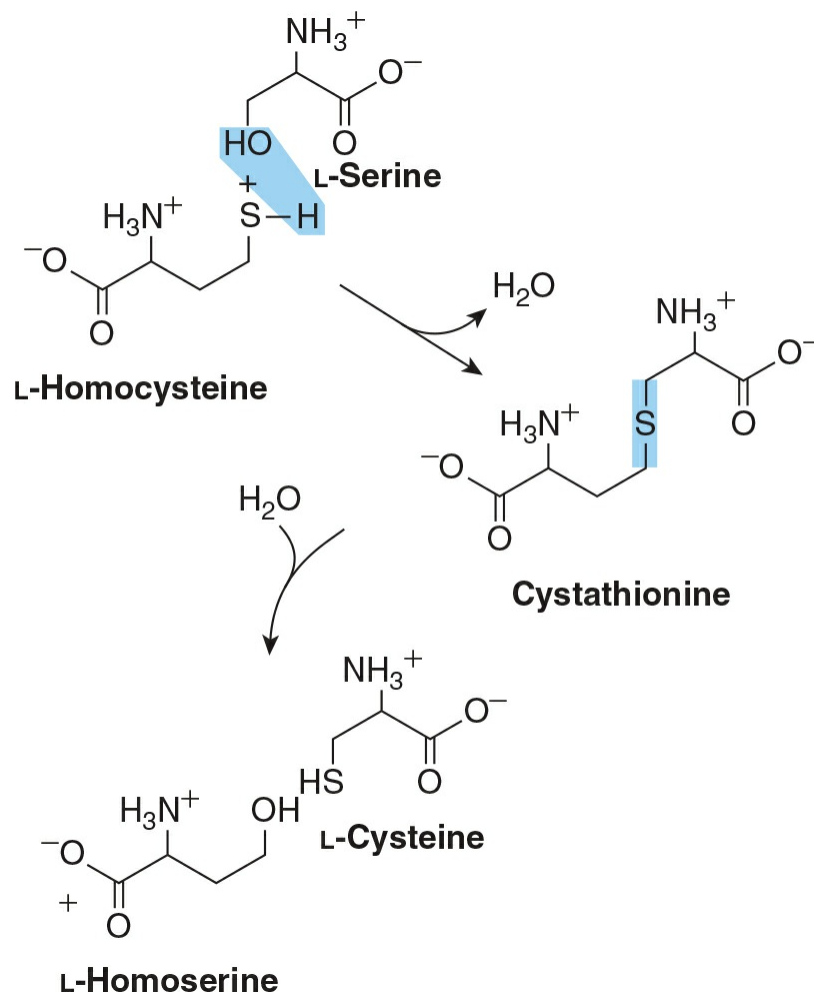

FIGURE 27–11 Conversion of homocysteine and serine to homoserine and cysteine. The sulfur of cysteine derives from methionine and the carbon skeleton from serine. The catalysts are cystathionine β -synthase

(EC 4.2.1.22) and cystathionine γ -lyase (EC 4.4.1.1).

Tyrosine

Phenylalanine hydroxylase converts phenylalanine to tyrosine (**Figure 27–12**). If the diet contains adequate quantities of the nutritionally essential amino acid phenylalanine, tyrosine is nutritionally nonessential. However, since the phenylalanine hydroxylase reaction is irreversible, dietary tyrosine cannot replace phenylalanine. Catalysis by this mixed-function oxidase incorporates one atom of O_2 into the *para* position of phenylalanine and reduces the other atom to water. Reducing power, provided as tetrahydrobiopterin, derives ultimately from NADPH.

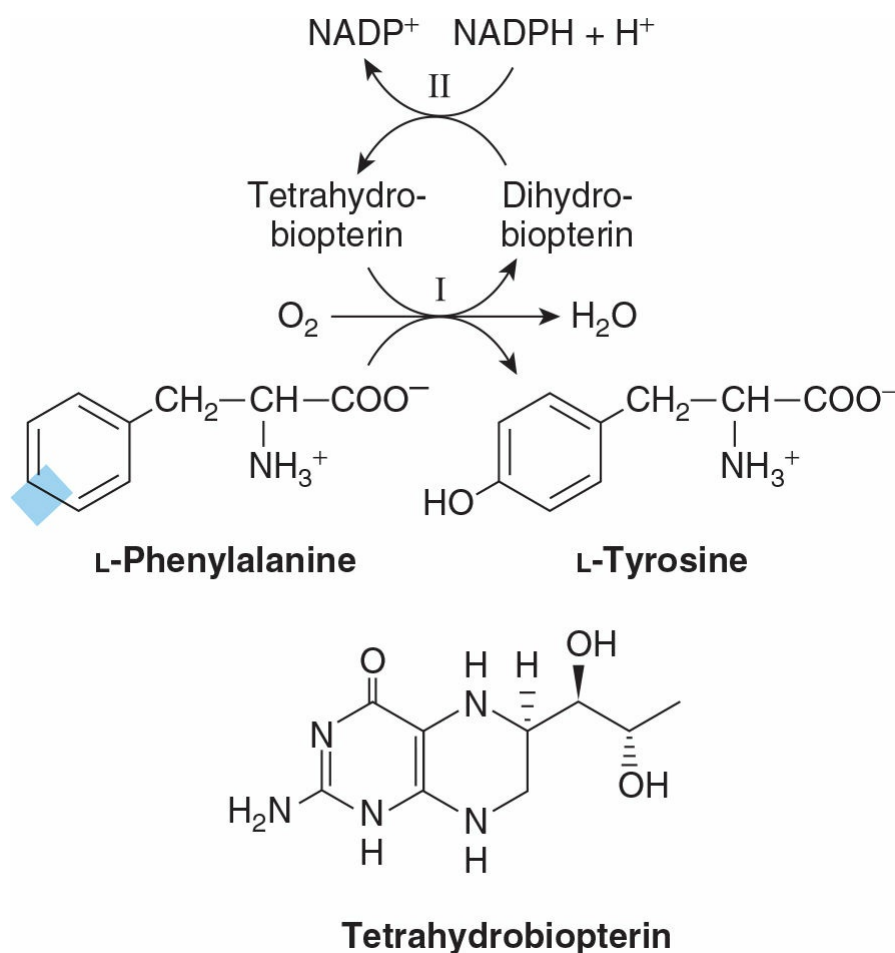

FIGURE 27–12 Conversion of phenylalanine to tyrosine by phenylalanine hydroxylase (EC 1.14.16.1). Two distinct enzymatic activities are involved. Activity II catalyzes reduction of dihydrobiopterin by NADPH, and activity I the reduction of O_2 to H_2O and of phenylalanine to tyrosine. This reaction is associated with several defects of phenylalanine metabolism discussed in [Chapter 29](#).

Hydroxyproline & Hydroxylysine

Hydroxyproline and hydroxylysine occur principally in collagen. Since there is no tRNA for either hydroxylated amino acid, neither dietary hydroxyproline nor dietary hydroxylysine is incorporated during protein synthesis. Peptidyl hydroxyproline and hydroxylysine arise from proline and lysine, but only after these amino acids have been incorporated into peptides. Hydroxylation of peptidyl prolyl and peptidyl lysyl residues, catalyzed by **prolyl hydroxylase** and **lysyl hydroxylase** of skin, skeletal muscle, and granulating wounds requires, in addition to the substrate, molecular O_2 , ascorbate, Fe^{2+} , and α -ketoglutarate (**Figure 27–13**). For every mole of proline or lysine hydroxylated, one mole of α -ketoglutarate is decarboxylated to succinate. The hydroxylases are mixed-function oxidases. One atom of O_2 is incorporated into proline or lysine, the other into succinate (**Figure 27–13**). A deficiency of the vitamin C required for these two hydroxylases results in **scurvy**, in which bleeding gums, swelling joints, and impaired wound healing result from the impaired stability of collagen (see **Chapters 5** and **50**).

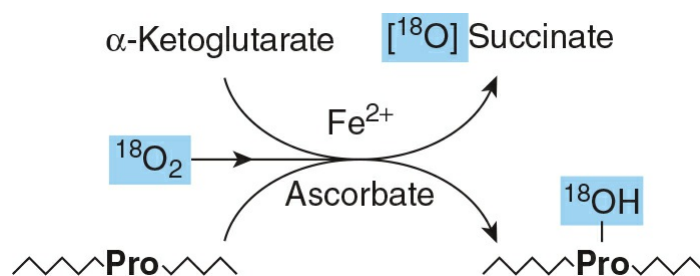

FIGURE 27–13 Hydroxylation of a proline-rich peptide. Molecular oxygen is incorporated into both succinate and proline. Procollagen-proline 4-hydroxylase (EC 1.14.11.2) thus is a mixed-function oxidase. Procollagen-lysine 5-hydroxylase (EC 1.14.11.4) catalyzes an analogous reaction.

Valine, Leucine, & Isoleucine

While leucine, valine, and isoleucine are all nutritionally essential amino acids, tissue aminotransferases reversibly interconvert all three amino acids and their corresponding α -keto acids. These α -keto acids thus can replace their amino acids in the diet.

Selenocysteine, the 21st Amino Acid

While the occurrence of selenocysteine (**Figure 27–14**) in proteins is uncommon, at least 25 human selenoproteins are known. Selenocysteine is present at the active site of several human enzymes that catalyze redox reactions. Examples include thioredoxin reductase, glutathione peroxidase, and the deiodinase that converts thyroxine to triiodothyronine. Where present, selenocysteine participates in the catalytic mechanism of these enzymes. Significantly, the replacement of selenocysteine by cysteine can actually *reduce* catalytic activity. Impairments in human selenoproteins have been implicated in tumorigenesis and atherosclerosis, and are associated with selenium deficiency cardiomyopathy (Keshan disease).

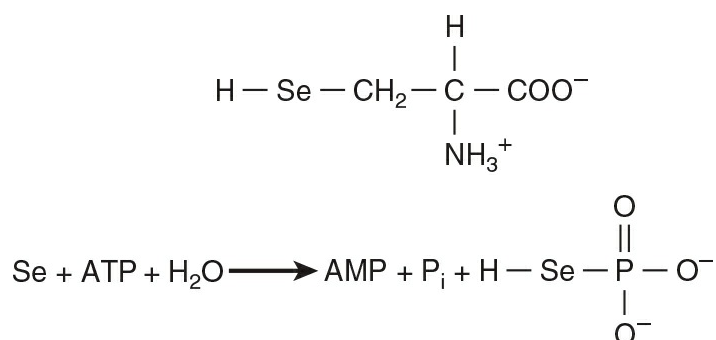

FIGURE 27–14 Selenocysteine (top) and the reaction catalyzed by selenophosphate synthetase (EC 2.7.9.3) (bottom).

Biosynthesis of selenocysteine requires serine, selenate (SeO_4^{2-}), ATP, a specific tRNA, and several enzymes. Serine provides the carbon skeleton of selenocysteine. Selenophosphate, formed from ATP and selenate (**Figure 27–14**), serves as the selenium donor. Unlike 4-hydroxyproline or 5-hydroxylysine, selenocysteine arises *cotranslationally* during its incorporation into peptides. The UGA anticodon of the unusual tRNA called tRNA^{Sec} normally signals STOP. The ability of the protein synthetic apparatus to identify a selenocysteine-specific UGA codon involves the selenocysteine insertion element, a stem-loop structure in the untranslated region of the mRNA. tRNA^{Sec} is first charged with serine by the ligase that charges tRNA^{Ser} . Subsequent replacement of the serine oxygen by selenium involves selenophosphate formed by selenophosphate synthetase (**Figure 27–14**). Successive enzyme-catalyzed reactions convert cysteyl- tRNA^{Sec} to aminoacrylyl- tRNA^{Sec} and then to selenocysteyl- tRNA^{Sec} . In the presence of a specific elongation factor that recognizes selenocysteyl- tRNA^{Sec} , selenocysteine can then be incorporated into proteins.

SUMMARY

- All vertebrates can form certain amino acids from amphibolic intermediates or from other dietary amino acids. The intermediates and the amino acids to which they give rise are α -ketoglutarate (Glu, Gln, Pro, Hyp), oxaloacetate (Asp, Asn), and 3-phosphoglycerate (Ser, Gly).
- Cysteine, tyrosine, and hydroxylysine are formed from nutritionally essential amino acids. Serine provides the carbon skeleton and homocysteine the sulfur for cysteine biosynthesis.
- In scurvy, a nutritional disease that results from a deficiency of vitamin C, impaired hydroxylation of peptidyl proline and peptidyl lysine results in a failure to provide the substrates for cross-linking of maturing collagens.
- Phenylalanine hydroxylase converts phenylalanine to tyrosine. Since the reaction catalyzed by this mixed function oxidase is irreversible, tyrosine cannot give rise to phenylalanine.
- Neither dietary hydroxyproline nor hydroxylysine is incorporated into proteins because no codon or tRNA dictates their insertion into peptides.
- Peptidyl hydroxyproline and hydroxylysine are formed by hydroxylation of peptidyl proline or lysine in reactions catalyzed by mixed-function oxidases that require vitamin C as cofactor.
- Selenocysteine, an essential active site residue in several mammalian enzymes, arises by cotranslational insertion from a previously modified tRNA.

REFERENCES

- Beckett GJ, Arthur JR: Selenium and endocrine systems. *J Endocrinol* 2005;184:455.
- Bender DA: *Amino Acid Metabolism*, 3rd ed. Wiley, 2012.
- Donovan J, Copeland PR: The efficiency of selenocysteine incorporation is regulated by translation initiation factors. *J Mol Biol* 2010;400:659.
- Kilberg MS: Asparagine synthetase chemotherapy. *Annu Rev Biochem* 2006;75:629.
- Ruzzo EK, Capo-Chichi JM, Ben-Zeev B, et al: Deficiency of asparagine synthetase causes congenital microcephaly and a progressive form of encephalopathy. *Neuron* 2013;80:429.
- Stickel F, Inderbitzin D, Candinas D: Role of nutrition in liver

transplantation for end-stage chronic liver disease. *Nutr Rev* 2008;66:47.

Turanov AA, Shchedrina VA, Everley RA, et al: Selenoprotein S is involved in maintenance and transport of multiprotein complexes. *Biochem J* 2014;462:555.

Catabolism of Proteins & of Amino Acid Nitrogen

Victor W. Rodwell, PhD

OBJECTIVES

After studying this chapter, you should be able to:

- Describe protein turnover, indicate the mean rate of protein turnover in healthy individuals, and provide examples of human proteins that are degraded at rates greater than the mean rate.
- Outline the events in protein turnover by both ATP-dependent and ATP-independent pathways, and indicate the roles in protein degradation played by the proteasome, ubiquitin, cell surface receptors, circulating asialoglycoproteins, and lysosomes.
- Indicate how the ultimate end products of nitrogen catabolism in mammals differ from those in birds and fish.
- Illustrate the central roles of transaminases (aminotransferases), of glutamate dehydrogenase, and of glutaminase in human nitrogen metabolism.
- Use structural formulas to represent the reactions that convert NH_3 , CO_2 , and the amide nitrogen of aspartate into urea, and identify the subcellular locations of the enzymes that catalyze urea

biosynthesis.

- Indicate the roles of allosteric regulation and of acetylglutamate in the regulation of the earliest steps in urea biosynthesis.
- Explain why metabolic defects in different enzymes of urea biosynthesis, although distinct at the molecular level, present similar clinical signs and symptoms.
- Describe both the classical approaches and the role of tandem mass spectrometry in screening neonates for inherited metabolic diseases.

BIOMEDICAL IMPORTANCE

In normal adults, nitrogen intake matches nitrogen excreted. Positive nitrogen balance, an excess of ingested over excreted nitrogen, accompanies growth and pregnancy. Negative nitrogen balance, where output exceeds intake, may follow surgery, advanced cancer, and the nutritional disorders kwashiorkor and marasmus. Genetic disorders that result from defects in the genes that encode ubiquitin, ubiquitin ligases, or deubiquitinating enzymes that participate in the degradation of certain proteins include Angelman syndrome, juvenile Parkinson disease, von Hippel-Lindau syndrome, and congenital polycythemia. This chapter describes how the nitrogen of amino acids is converted to urea, and the metabolic disorders that accompany defects in this process. Ammonia, which is highly toxic, arises in humans primarily from the α -amino nitrogen of amino acids. Tissues therefore convert ammonia to the amide nitrogen of the nontoxic amino acid glutamine. Subsequent deamination of glutamine in the liver releases ammonia, which is efficiently converted to urea, which is not toxic. However, if liver function is compromised, as in cirrhosis or hepatitis, elevated blood ammonia levels generate clinical signs and symptoms. Each enzyme of the urea cycle provides examples of metabolic defects and their physiologic consequences. In addition, the urea cycle provides a useful molecular model for the study of other human metabolic defects.

PROTEIN TURNOVER

The continuous degradation and synthesis (turnover) of cellular proteins occur in all forms of life. Each day, humans turn over 1 to 2% of their total body protein, principally muscle protein. High rates of protein degradation

occur in tissues that are undergoing structural rearrangement, for example, uterine tissue during pregnancy, skeletal muscle in starvation, and tadpole tail tissue during metamorphosis. While approximately 75% of the amino acids liberated by protein degradation are reutilized, the remaining excess free amino acids are not stored for future use. Amino acids not immediately incorporated into new protein are rapidly degraded. The major portion of the carbon skeletons of the amino acids is converted to amphibolic intermediates, while in humans the amino nitrogen is converted to urea and excreted in the urine.

PROTEASES & PEPTIDASES DEGRADE PROTEINS TO AMINO ACIDS

The relative susceptibility of a protein to degradation is expressed as its **half-life ($t_{1/2}$)**, the time required to lower its concentration to half of its initial value. Half-lives of liver proteins range from under 30 minutes to over 150 hours. Typical “housekeeping” enzymes such as those of glycolysis, have $t_{1/2}$ values of over 100 hours. By contrast, key regulatory enzymes may have $t_{1/2}$ values as low as 0.5 to 2 hours. PEST sequences, regions rich in proline (P), glutamate (E), serine (S), and threonine (T), target some proteins for rapid degradation. Intracellular proteases hydrolyze internal peptide bonds. The resulting peptides are then degraded to amino acids by endopeptidases that hydrolyze internal peptide bonds, and by aminopeptidases and carboxypeptidases that remove amino acids sequentially from the amino- and carboxyl-termini, respectively.

ATP-Independent Degradation

Degradation of blood glycoproteins (see [Chapter 46](#)) follows loss of a sialic acid moiety from the nonreducing ends of their oligosaccharide chains. Asialoglycoproteins are then internalized by liver-cell asialoglycoprotein receptors and degraded by lysosomal proteases. Extracellular, membrane-associated, and long-lived intracellular proteins are also degraded in lysosomes by ATP-independent processes.

ATP & Ubiquitin-Dependent Degradation

Degradation of regulatory proteins with short half-lives and of abnormal or misfolded proteins occurs in the cytosol, and requires ATP and **ubiquitin**. Named based on its presence in all eukaryotic cells, ubiquitin is a small

(8.5 kDa, 76 residue) polypeptide that targets many intracellular proteins for degradation. The primary structure of ubiquitin is highly conserved. Only 3 of 76 residues differ between yeast and human ubiquitin. **Figure 28–1** illustrates the three-dimensional structure of ubiquitin. Ubiquitin molecules are attached by **non- α -peptide bonds** formed between the carboxyl terminal of ubiquitin and the ϵ -amino groups of lysyl residues in the target protein (**Figure 28–2**). The residue present at its amino terminus affects whether a protein is ubiquitinated. Amino terminal Met or Ser residues retard, whereas Asp or Arg accelerate ubiquitination. Attachment of a single ubiquitin molecule to transmembrane proteins alters their subcellular localization and targets them for degradation. Soluble proteins undergo **polyubiquitination**, the ligase-catalyzed attachment of four or more additional ubiquitin molecules (**Figure 28–1**). Subsequent degradation of ubiquitin-tagged proteins takes place in the **proteasome**, a macromolecule that also is ubiquitous in eukaryotic cells. The proteasome consists of a macromolecular, cylindrical complex of proteins, whose stacked rings form a central pore that harbors the active sites of proteolytic enzymes. For degradation, a protein thus must first enter the central pore. Entry into the core is regulated by the two outer rings that recognize polyubiquitinated proteins (**Figures 28–3** and **28–4**).

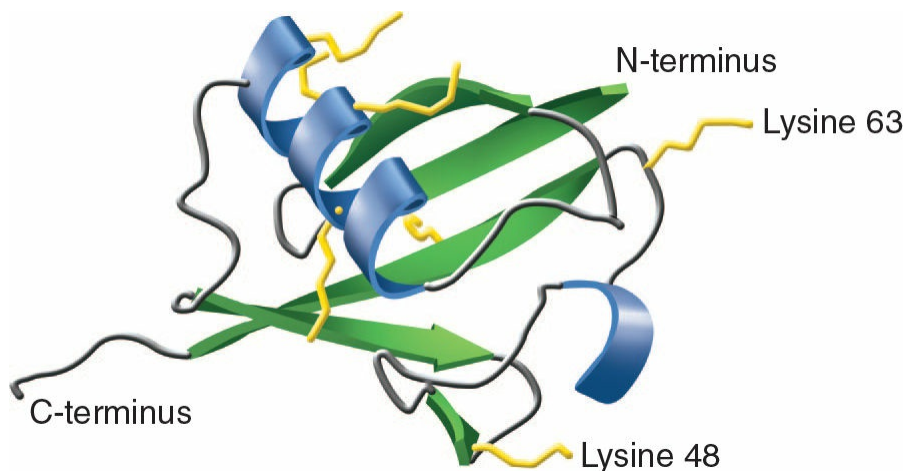

FIGURE 28–1 Three-dimensional structure of ubiquitin. Shown are α -helices (blue), β -strands (green), and the R-groups of lysyl residues (orange). Lys48 & Lys63 are sites for attachment of additional ubiquitin molecules during polyubiquitination. Created by Rogerdodd at Wikipedia using PyMOL, PDB id 1ubi, and crediting the European Bioinformatics Institute.

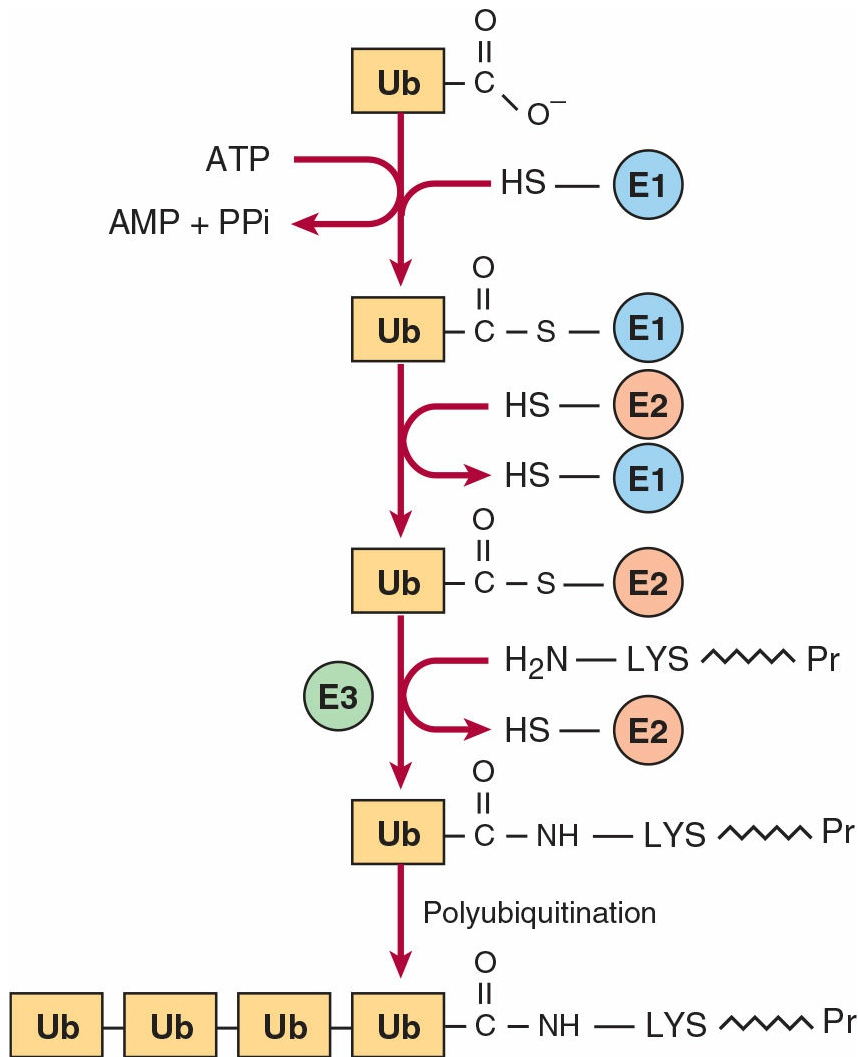

FIGURE 28–2 Reactions involved in the attachment of ubiquitin (Ub) to proteins. Three enzymes are involved. E1 is an activating enzyme, E2 a transferase, and E3 a ligase. While depicted as single entities, there are several types of E1, and over 500 types of E2. The terminal COOH of ubiquitin first forms a thioester. The coupled hydrolysis of PP_i by pyrophosphatase ensures that the reaction will proceed readily. A thioester exchange reaction now transfers activated ubiquitin to E2. E3 then catalyzes the transfer of ubiquitin to the ε-amino group of a lysyl residue of the target protein. Additional rounds of ubiquitination result in subsequent polyubiquitination.

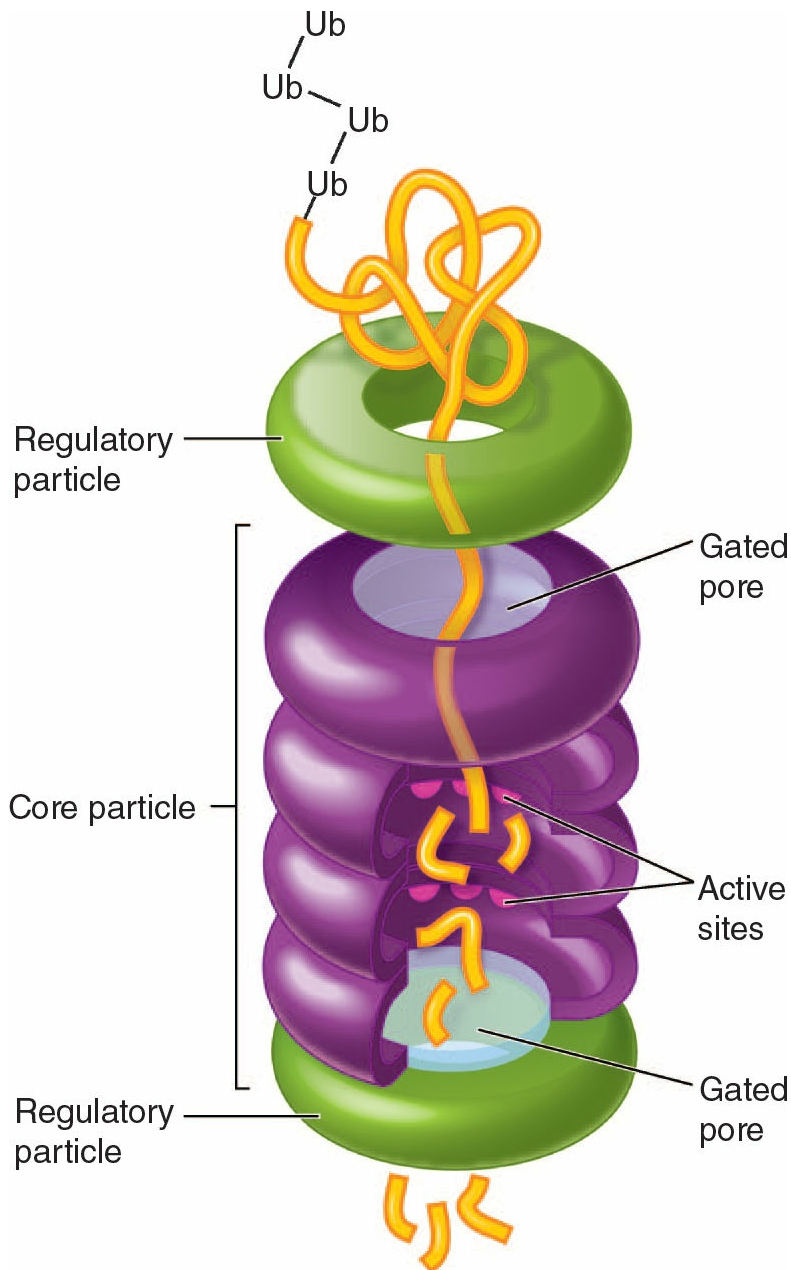

FIGURE 28–3 Representation of the structure of a proteasome. The upper ring is gated to permit only polyubiquitinated proteins to enter the proteasome, where immobilized internal proteases degrade them to peptides.

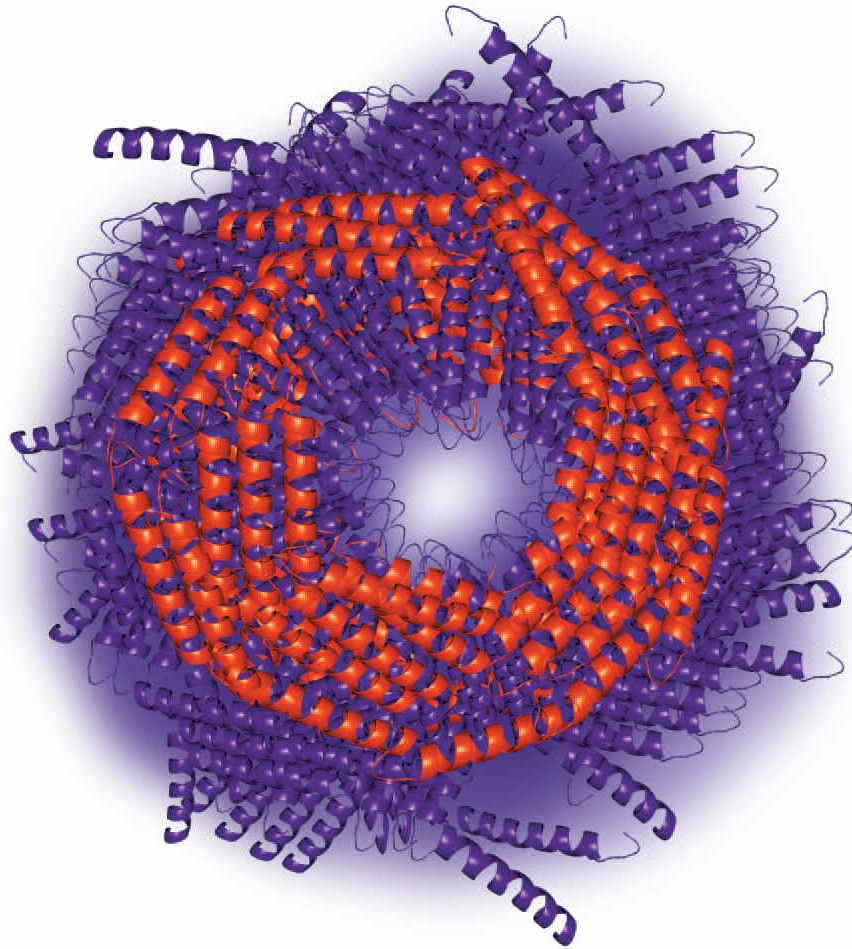

FIGURE 28–4 An end-on view of a proteasome. Created by Rogerdodd at Wikipedia and crediting the European Bioinformatics Institute.

For the discovery of ubiquitin-mediated protein degradation, Aaron Ciechanover and Avram Hershko of Israel and Irwin Rose of the United States were awarded the 2004 Nobel Prize in Chemistry. Genetic disorders that result from defects in the genes that encode ubiquitin, ubiquitin ligases, or deubiquitinating enzymes include Angelman syndrome, autosomal recessive juvenile Parkinson disease, von Hippel-Lindau syndrome, and congenital polycythemia. For additional aspects of protein degradation and of ubiquitination, including its role in the cell cycle, see [Chapters 4 and 35](#).

INTERORGAN EXCHANGE MAINTAINS CIRCULATING LEVELS OF AMINO ACIDS

The maintenance of steady-state concentrations of circulating plasma amino acids between meals depends on the net balance between release

from endogenous protein stores and utilization by various tissues. Muscle generates over half of the total body pool of free amino acids, and liver is the site of the urea cycle enzymes necessary for disposal of excess nitrogen. Muscle and liver thus play major roles in maintaining circulating amino acid levels.

Figure 28–5 summarizes the postabsorptive state. Free amino acids, particularly alanine and glutamine, are released from muscle into the circulation. Alanine is extracted primarily by the liver, and glutamine is extracted by the gut and the kidney, both of which convert a significant portion to alanine. Glutamine also serves as a source of ammonia for excretion by the kidney. The kidney provides a major source of serine for uptake by peripheral tissues, including liver and muscle. Branched-chain amino acids, particularly valine, are released by muscle and taken up predominantly by the brain.

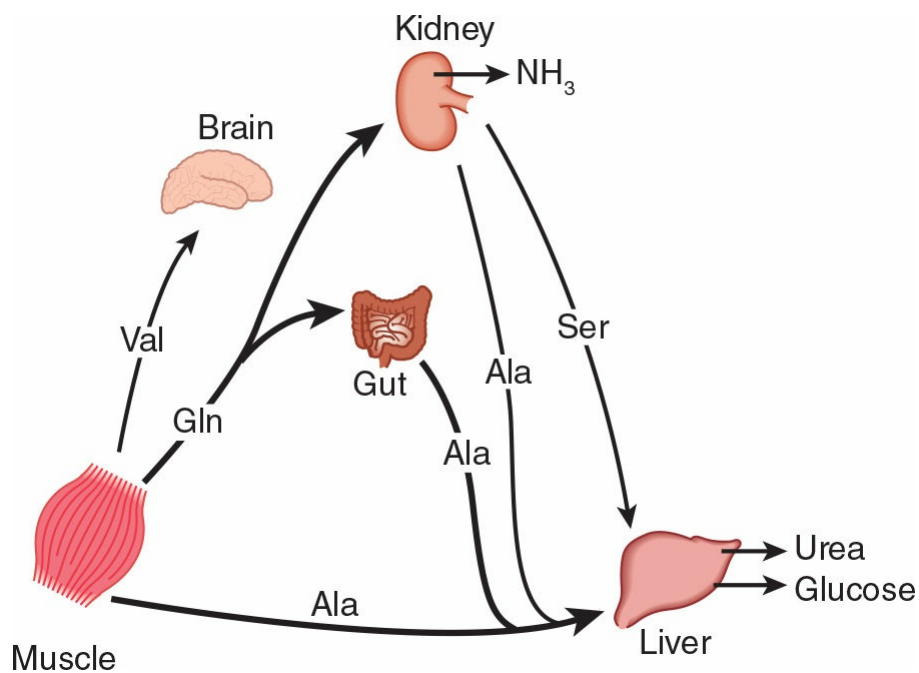

FIGURE 28–5 Interorgan amino acid exchange in normal postabsorptive humans. The key role of alanine in amino acid output from muscle and gut and uptake by the liver is shown.

Alanine is a key **gluconeogenic amino acid** (**Figure 28–6**). The rate of hepatic gluconeogenesis from alanine is far higher than from all other amino acids. The capacity of the liver for gluconeogenesis from alanine does not reach saturation until the alanine concentration reaches 20 to 30 times its normal physiologic level. Following a protein-rich meal, the splanchnic tissues release amino acids (**Figure 28–7**) while the peripheral

muscles extract amino acids, in both instances predominantly branched-chain amino acids. Branched-chain amino acids thus serve a special role in nitrogen metabolism. In the fasting state, they provide the brain with an energy source, and postprandially they are extracted predominantly by muscle, having been spared by the liver.

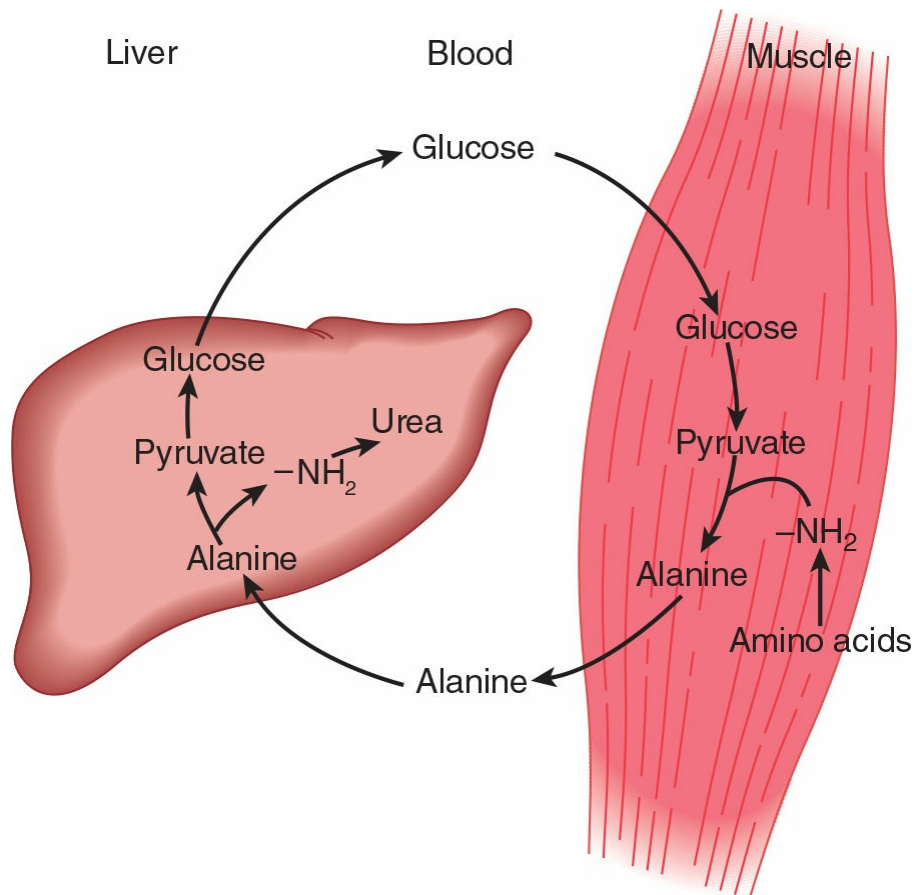

FIGURE 28–6 The glucose-alanine cycle. Alanine is synthesized in muscle by transamination of glucose-derived pyruvate, released into the bloodstream, and taken up by the liver. In the liver, the carbon skeleton of alanine is reconverted to glucose and released into the bloodstream, where it is available for uptake by muscle and resynthesis of alanine.

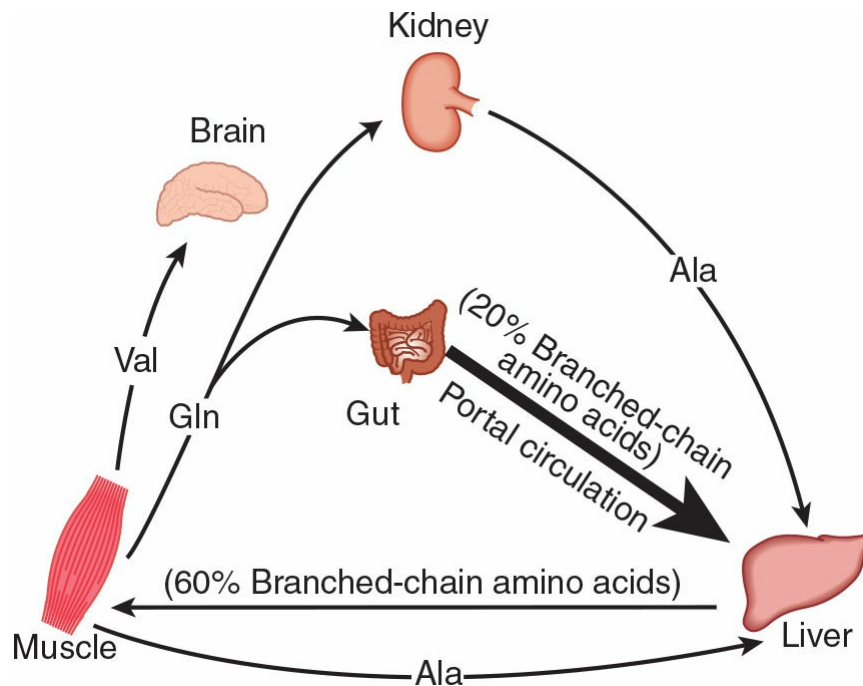

FIGURE 28–7 Summary of amino acid exchange between organs immediately after feeding.

ANIMALS CONVERT α -AMINO NITROGEN TO VARIED END PRODUCTS

Depending on their ecological niche and physiology, different animals excrete excess nitrogen as ammonia, uric acid, or urea. The aqueous environment of teleostean fish, which are **ammonotelic** (excrete ammonia), permits them to excrete water continuously to facilitate excretion of ammonia, which is highly toxic. While this approach is appropriate for an aquatic animal, birds must both conserve water and maintain low weight. Birds, which are **uricotelic**, address both problems by excreting nitrogen-rich uric acid (see [Figure 33–11](#)) as semisolid guano. Many land animals, including humans, are **ureotelic** and excrete nontoxic, highly water-soluble urea. Since urea is nontoxic to humans, high blood levels in renal disease are a consequence, not a cause, of impaired renal function.

BIOSYNTHESIS OF UREA

Urea biosynthesis occurs in four stages: (1) transamination, (2) oxidative deamination of glutamate, (3) ammonia transport, and (4) reactions of the urea cycle ([Figure 28–8](#)). The expression in liver of the RNAs for all the enzymes of the urea cycle increases severalfold in starvation, probably

secondary to enhanced protein degradation to provide energy.

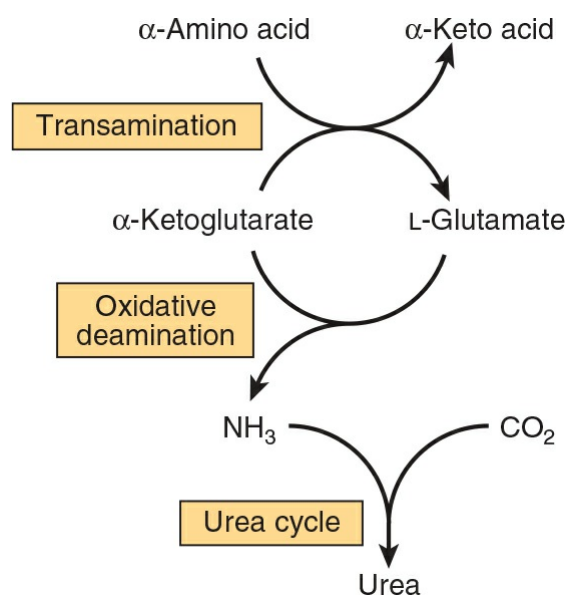

FIGURE 28–8 Overall flow of nitrogen in amino acid catabolism.

Transamination Transfers α -Amino Nitrogen to α -Ketoglutarate, Forming Glutamate

Transamination reactions interconvert pairs of α -amino acids and α -keto acids (**Figure 28–9**). Transamination reactions, which are freely reversible, also function in amino acid biosynthesis (see **Figure 27–4**). All of the common amino acids except lysine, threonine, proline, and hydroxyproline participate in transamination. Transamination is not restricted to α -amino groups. The δ -amino group of ornithine (but not the ϵ -amino group of lysine) readily undergoes transamination.

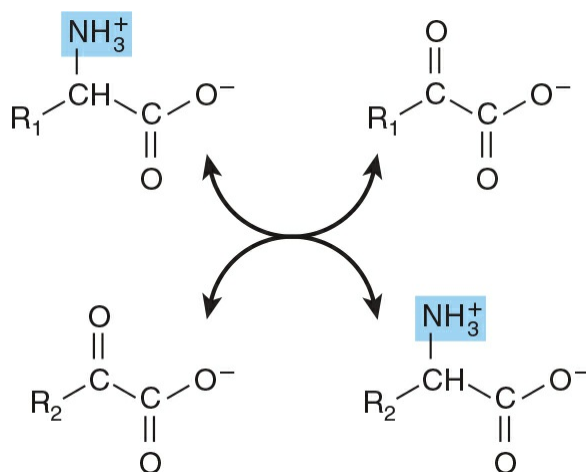

FIGURE 28–9 Transamination. The reaction is freely reversible with an

equilibrium constant close to unity.

Alanine-pyruvate aminotransferase (alanine aminotransferase, EC 2.6.1.2) and glutamate- α -ketoglutarate aminotransferase (glutamate aminotransferase, EC 2.6.1.1) catalyze the transfer of amino groups to pyruvate (forming alanine) or to α -ketoglutarate (forming glutamate).

Each aminotransferase is specific for one pair of substrates, but nonspecific for the other pair. Since alanine is also a substrate for glutamate aminotransferase, the α -amino nitrogen from all amino acids that undergo transamination can be concentrated in glutamate. This is important because L-glutamate is the only amino acid that undergoes oxidative deamination at an appreciable rate in mammalian tissues. The formation of ammonia from α -amino groups thus occurs mainly via the α -amino nitrogen of L-glutamate.

Transamination occurs via a “ping-pong” mechanism characterized by the alternate addition of a substrate and release of a product (**Figure 28–10**). Following removal of its α -amino nitrogen by transamination, the remaining carbon “skeleton” of an amino acid is degraded by pathways discussed in **Chapter 29**.

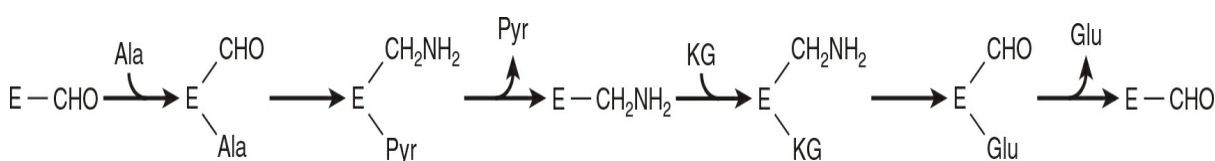

FIGURE 28–10 “Ping-pong” mechanism for transamination. E—CHO and E—CH₂NH₂ represent enzyme-bound pyridoxal phosphate and pyridoxamine phosphate, respectively. (Ala, alanine; Glu, glutamate; KG, α -ketoglutarate; Pyr, pyruvate.)

Pyridoxal phosphate (PLP), a derivative of vitamin B₆, is present at the catalytic site of all aminotransferases, and plays a key role in catalysis. During transamination, PLP serves as a “carrier” of amino groups. An enzyme-bound Schiff base (**Figure 28–11**) is formed between the oxo group of enzyme-bound PLP and the α -amino group of an α -amino acid. The Schiff base can rearrange in various ways. In transamination, rearrangement forms an α -keto acid and enzyme-bound pyridoxamine phosphate. As noted earlier, certain diseases are associated with elevated serum levels of aminotransferases (see **Table 7–1**).

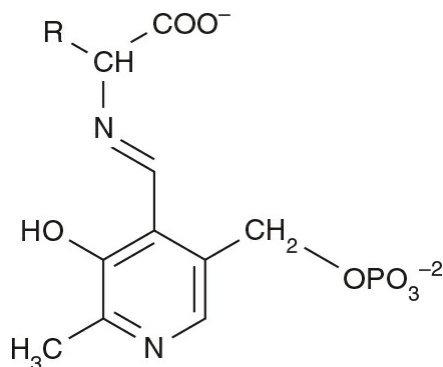

FIGURE 28–11 Structure of a Schiff base formed between pyridoxal phosphate and an amino acid.

L-GLUTAMATE DEHYDROGENASE OCCUPIES A CENTRAL POSITION IN NITROGEN METABOLISM

Transfer of amino nitrogen to α -ketoglutarate forms L-glutamate. Hepatic **L-glutamate dehydrogenase** (GDH), which can use either NAD^+ or NADP^+ , releases this nitrogen as ammonia (**Figure 28–12**). Conversion of α -amino nitrogen to ammonia by the concerted action of glutamate aminotransferase and GDH is often termed “transdeamination.” Liver GDH activity is allosterically inhibited by ATP, GTP, and NADH, and is activated by ADP. The GDH reaction is freely reversible, and also functions in amino acid biosynthesis (see **Figure 27–1**).

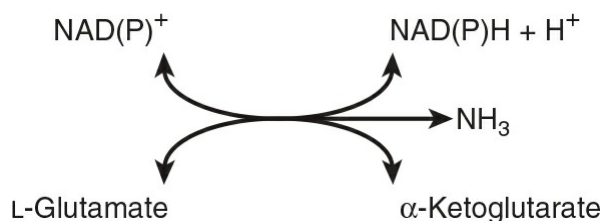

FIGURE 28–12 The reaction catalyzed by glutamate dehydrogenase, **EC 1.4.1.2**. NAD(P)^+ means that either NAD^+ or NADP^+ can serve as the oxidoreductant. The reaction is reversible, but strongly favors glutamate formation.

AMINO ACID OXIDASES REMOVE NITROGEN AS AMMONIA

L-Amino acid oxidase of liver and kidney convert an amino acid to an α -

imino acid that decomposes to an α -keto acid with release of ammonium ion (**Figure 28–13**). The reduced flavin is reoxidized by molecular oxygen, forming hydrogen peroxide (H_2O_2), which then is split to O_2 and H_2O by **catalase**, EC 1.11.1.6.

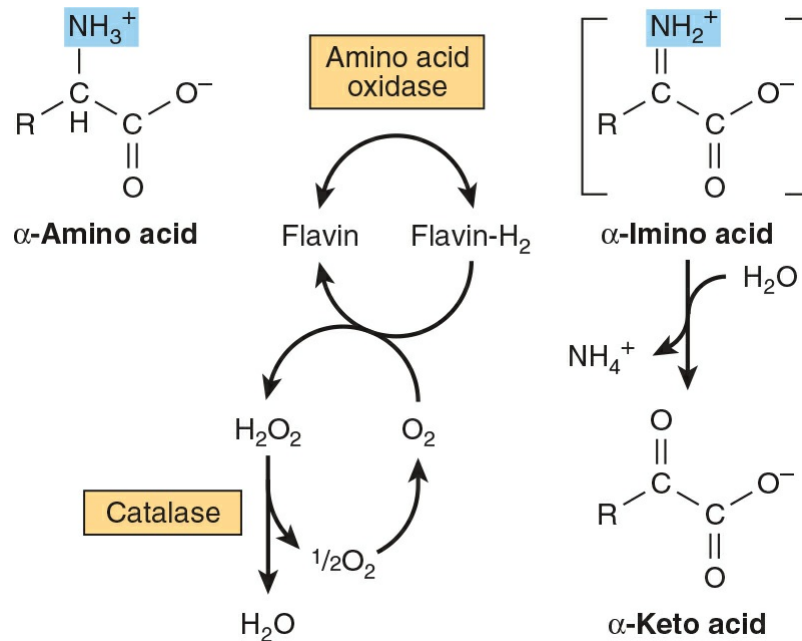

FIGURE 28–13 Oxidative deamination catalyzed by L-amino acid oxidase (L- α -amino acid: O_2 oxidoreductase, EC 1.4.3.2). The α -imino acid, shown in brackets, is not a stable intermediate.

Ammonia Intoxication Is Life-Threatening

The ammonia produced by enteric bacteria and absorbed into portal venous blood and the ammonia produced by tissues are rapidly removed from circulation by the liver and converted to urea. Thus, normally, only traces (10-20 $\mu\text{g}/\text{dL}$) are present in peripheral blood. This is essential, since ammonia is toxic to the central nervous system. Should portal blood bypass the liver, systemic blood ammonia may reach toxic levels. This occurs in severely impaired hepatic function or the development of collateral links between the portal and systemic veins in cirrhosis. Symptoms of **ammonia intoxication** include tremor, slurred speech, blurred vision, coma, and ultimately death. Ammonia may be toxic to the brain in part because it reacts with α -ketoglutarate to form glutamate. The resulting depletion of α -ketoglutarate then impairs function of the tricarboxylic acid (TCA) cycle in neurons.

Glutamine Synthetase Fixes Ammonia as Glutamine

Formation of glutamine is catalyzed by mitochondrial **glutamine synthetase** (Figure 28–14). Since amide bond synthesis is coupled to the hydrolysis of ATP to ADP and P_i , the reaction strongly favors glutamine synthesis. During catalysis, glutamate attacks the γ -phosphoryl group of ATP, forming γ -glutamyl phosphate and ADP. Following deprotonation of NH_4^+ , NH_3 attacks γ -glutamyl phosphate, and glutamine and P_i are released. In addition to providing glutamine to serve as a carrier of nitrogen, carbon and energy between organs (Figure 28–5), glutamine synthetase plays a major role both in ammonia detoxification and in acid–base homeostasis. A rare deficiency in neonate glutamine synthetase results in severe brain damage, multiorgan failure, and death.

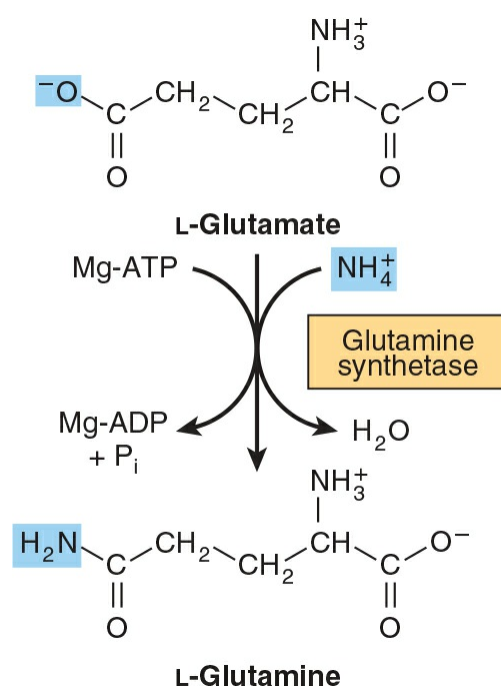

FIGURE 28–14 Formation of glutamine, catalyzed by glutamine synthetase, EC 6.3.1.2.

Glutaminase & Asparaginase Deamidate Glutamine & Asparagine

There are two human isoforms of mitochondrial **glutaminase**, termed liver-type and renal-type glutaminase. Products of different genes, the glutaminases differ with respect to their structure, kinetics, and regulation. Hepatic glutaminase levels rise in response to high protein intake while renal kidney-type glutaminase increases in metabolic acidosis. Hydrolytic

release of the amide nitrogen of glutamine as ammonia, catalyzed by glutaminase (**Figure 28–15**), strongly favors glutamate formation. An analogous reaction is catalyzed by L-asparaginase (EC 3.5.1.1). The concerted action of glutamine synthetase and glutaminase thus catalyzes the interconversion of free ammonium ion and glutamine.

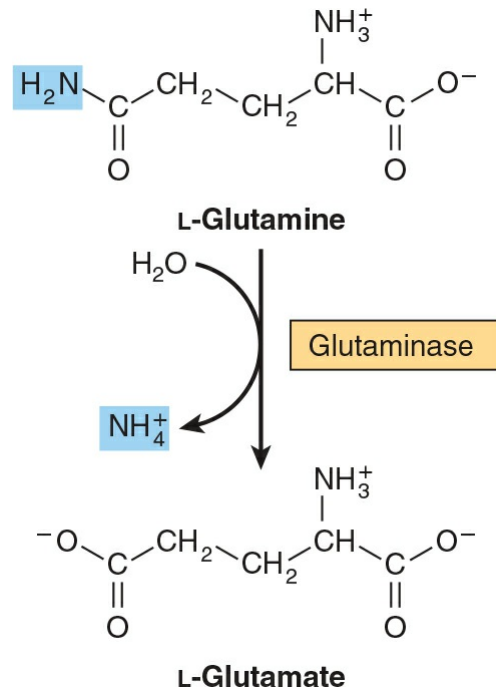

FIGURE 28–15 The reaction catalyzed by glutaminase, EC 3.5.1.2. The reaction proceeds essentially irreversibly in the direction of glutamate and NH_4^+ formation. Note that the *amide* nitrogen, not the α -amino nitrogen, is removed.

Formation & Secretion of Ammonia Maintains Acid–Base Balance

Excretion into urine of ammonia produced by renal tubular cells facilitates cation conservation and regulation of acid–base balance. Ammonia production from intracellular renal amino acids, especially glutamine, increases in **metabolic acidosis** and decreases in **metabolic alkalosis**.

Urea is the Major End Product of Nitrogen Catabolism in Humans

Synthesis of 1 mol of urea requires 3 mol of ATP, 1 mol each of ammonium ion and of aspartate, and employs five enzymes (**Figure 28–**

16). Of the six participating amino acids, *N*-acetylglutamate functions solely as an enzyme activator. The others serve as carriers of the atoms that ultimately become urea. The major metabolic role of **ornithine**, **citrulline**, and **argininosuccinate** in mammals is urea synthesis. Urea synthesis is a cyclic process. While ammonium ion, CO₂, ATP, and aspartate are consumed, the ornithine consumed in reaction 2 is regenerated in reaction 5. Thus, there is no net loss or gain of ornithine, citrulline, argininosuccinate, or arginine. As indicated in [Figure 28–16](#), some reactions of urea synthesis occur in the matrix of the mitochondrion, and other reactions in the cytosol.

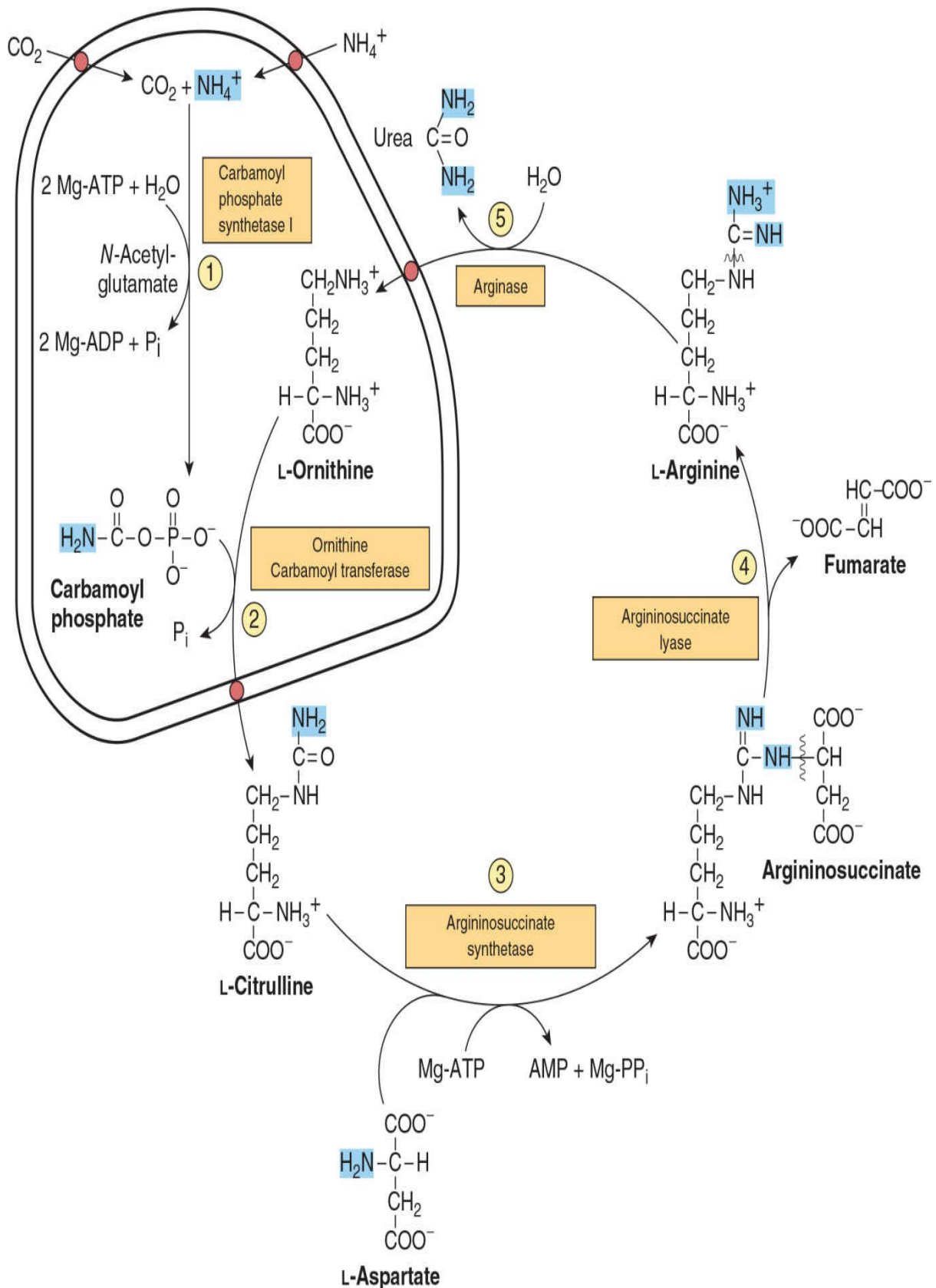

FIGURE 28–16 Reactions and intermediates of urea biosynthesis. The nitrogen-containing groups that contribute to the formation of urea are shaded. Reactions ① and ② occur in the matrix of liver mitochondria and

reactions ③, ④, and ⑤ in liver cytosol. CO₂ (as bicarbonate), ammonium ion, ornithine, and citrulline enter the mitochondrial matrix via specific carriers (see red dots) present in the inner membrane of liver mitochondria.

Carbamoyl Phosphate Synthetase I Initiates Urea Biosynthesis

Condensation of CO₂, ammonia, and ATP to form **carbamoyl phosphate** is catalyzed by mitochondrial **carbamoyl phosphate synthetase I** (EC 6.3.4.16). A cytosolic form of this enzyme, carbamoyl phosphate synthetase II, uses glutamine rather than ammonia as the nitrogen donor and functions in pyrimidine biosynthesis (see [Figure 33–9](#)). The concerted action of glutamate dehydrogenase and carbamoyl phosphate synthetase I thus shuttles amino nitrogen into carbamoyl phosphate, a compound with high group transfer potential.

Carbamoyl phosphate synthetase I, the rate-limiting enzyme of the urea cycle, is active only in the presence of ***N*-acetylglutamate**, an allosteric activator that enhances the affinity of the synthetase for ATP. Synthesis of 1 mol of carbamoyl phosphate requires 2 mol of ATP. One ATP serves as the phosphoryl donor for formation of the mixed acid anhydride bond of carbamoyl phosphate. The second ATP provides the driving force for synthesis of the amide bond of carbamoyl phosphate. The other products are 2 mol of ADP and 1 mol of P_i (reaction 1, [Figure 28–16](#)). The reaction proceeds stepwise. Reaction of bicarbonate with ATP forms carbonyl phosphate and ADP. Ammonia then displaces ADP, forming carbamate and orthophosphate. Phosphorylation of carbamate by the second ATP then forms carbamoyl phosphate.

Carbamoyl Phosphate Plus Ornithine Forms Citrulline

L-Ornithine transcarbamoylase (EC 2.1.3.3) catalyzes transfer of the carbamoyl group of carbamoyl phosphate to ornithine, forming citrulline and orthophosphate (reaction 2, [Figure 28–16](#)). While the reaction occurs in the mitochondrial matrix, both the formation of ornithine and the subsequent metabolism of citrulline take place in the cytosol. Entry of ornithine into mitochondria and exodus of citrulline from mitochondria therefore involve mitochondrial inner membrane permeases ([Figure 28–16](#)).

Citrulline Plus Aspartate Forms Argininosuccinate

Argininosuccinate synthetase (EC 6.3.4.5) links aspartate and citrulline via the amino group of aspartate (reaction 3, [Figure 28–16](#)) and provides the second nitrogen of urea. The reaction requires ATP and involves intermediate formation of citrullyl-AMP. Subsequent displacement of AMP by aspartate then forms argininosuccinate.

Cleavage of Argininosuccinate Forms Arginine & Fumarate

Cleavage of argininosuccinate is catalyzed by **argininosuccinate lyase** (EC 4.3.2.1). The reaction proceeds with retention of all three nitrogens in arginine and release of the aspartate skeleton as fumarate (reaction 4, [Figure 28–16](#)). Subsequent addition of water to fumarate forms L-malate, whose subsequent NAD^+ -dependent oxidation forms oxaloacetate. These two reactions are analogous to reactions of the citric acid cycle, but are catalyzed by **cytosolic fumarase** and **malate dehydrogenase**. Transamination of oxaloacetate by glutamate aminotransferase then reforms aspartate. The carbon skeleton of aspartate-fumarate thus acts as a carrier of the nitrogen of glutamate into a precursor of urea.

Cleavage of Arginine Releases Urea & Reforms Ornithine

Hydrolytic cleavage of the guanidino group of arginine, catalyzed by liver **arginase** (EC 3.5.3.1), releases urea (reaction 5, [Figure 28–16](#)). The other product, ornithine, reenters liver mitochondria and participates in additional rounds of urea synthesis. Ornithine and lysine are potent inhibitors of arginase, and compete with arginine. Arginine also serves as the precursor of the potent muscle relaxant nitric oxide (NO) in a Ca^{2+} -dependent reaction catalyzed by NO synthetase.

Carbamoyl Phosphate Synthetase I Is the Pacemaker Enzyme of the Urea Cycle

The activity of carbamoyl phosphate synthetase I is determined by **N-acetylglutamate**, whose steady-state level is dictated by the balance between its rate of synthesis from acetyl-CoA and glutamate and its rate of hydrolysis to acetate and glutamate, reactions catalyzed by *N*-

acetylglutamate synthetase (NAGS) and *N*-acetylglutamate deacylase (hydrolase), respectively.

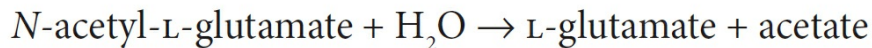
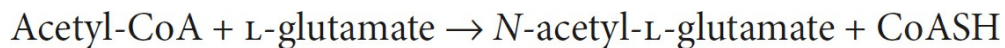

Major changes in diet can increase the concentrations of individual urea cycle enzymes 10- to 20-fold. For example, starvation elevates enzyme levels, presumably to cope with the increased production of ammonia that accompanies enhanced starvation-induced degradation of protein.

GENERAL FEATURES OF METABOLIC DISORDERS

The comparatively rare, but well-characterized and medically devastating metabolic disorders associated with the enzymes of urea biosynthesis illustrate the following general principles of inherited metabolic diseases.

1. Similar or identical clinical signs and symptoms can accompany various genetic mutations in a gene that encodes a given enzyme or in enzymes that catalyze successive reactions in a metabolic pathway.
2. Rational therapy is based on an understanding of the relevant biochemical enzyme-catalyzed reactions in both normal and impaired individuals.
3. The identification of intermediates and of ancillary products that accumulate prior to a metabolic block provides the basis for metabolic screening tests that can implicate the reaction that is impaired.
4. Definitive diagnosis involves quantitative assay of the activity of the enzyme suspected to be defective.
5. The DNA sequence of the gene that encodes a given mutant enzyme is compared to that of the wild-type gene to identify the specific mutation(s) that cause the disease.
6. The exponential increase in DNA sequencing of human genes has identified dozens of mutations of an affected gene that are benign or are associated with symptoms of varying severity of a given metabolic disorder.

METABOLIC DISORDERS ARE ASSOCIATED

WITH EACH REACTION OF THE UREA CYCLE

Five well-documented diseases represent defects in the biosynthesis of enzymes of the urea cycle. Molecular genetic analysis has pinpointed the loci of mutations associated with each deficiency, each of which exhibits considerable genetic and phenotypic variability (**Table 28–1**).

TABLE 28–1 Enzymes of Inherited Metabolic Disorders of the Urea Cycle

Enzyme	Enzyme Catalog Number	OMIM ^a Reference	Figure and Reaction
Carbamoyl-phosphate synthetase 1	6.3.4.16	237300	28-13①
Ornithine carbamoyl transferase	2.1.3.3	311250	28-13②
Argininosuccinate synthetase	6.3.4.5	215700	28-13③
Argininosuccinate lyase	4.3.2.1	608310	28-13④
Arginase	3.5.3.1	608313	28-13⑤

^aOnline Mendelian inheritance in man database: ncbi.nlm.nih.gov/omim/

Urea cycle disorders are characterized by hyperammonemia, encephalopathy, and respiratory alkalosis. Four of the five metabolic diseases, deficiencies of carbamoyl phosphate synthetase I, ornithine carbamoyl transferase, argininosuccinate synthetase, and argininosuccinate lyase, result in the accumulation of precursors of urea, principally ammonia and glutamine. Ammonia intoxication is most severe when the metabolic block occurs at reactions 1 or 2 (**Figure 28–16**), for if citrulline can be synthesized, some ammonia has already been removed by being covalently linked to an organic metabolite.

Clinical symptoms common to all urea cycle disorders include vomiting, avoidance of high-protein foods, intermittent ataxia, irritability, lethargy, and severe mental retardation. The most dramatic clinical presentation occurs in full-term infants who initially appear normal, then exhibit progressive lethargy, hypothermia, and apnea due to high plasma ammonia levels. The clinical features and treatment of all five disorders are similar. Significant improvement and minimization of brain damage can accompany a low-protein diet ingested as frequent small meals to avoid sudden increases in blood ammonia levels. The goal of dietary therapy is to provide sufficient protein, arginine, and energy to promote growth and development while simultaneously minimizing the metabolic

perturbations.

Carbamoyl Phosphate Synthetase I

N-Acetylglutamate is essential for the activity of carbamoyl phosphate synthetase I, EC 6.3.4.16 (reaction 1, [Figure 28–16](#)). Defects in carbamoyl phosphate synthetase I are responsible for the relatively rare (estimated frequency 1:62,000) metabolic disease termed “hyperammonemia type 1.”

N-Acetylglutamate Synthetase

N-Acetylglutamate synthetase, EC 2.3.1.1 (NAGS), catalyzes the formation from acetyl-CoA and glutamate of the *N*-acetylglutamate essential for carbamoyl phosphate synthetase I activity.

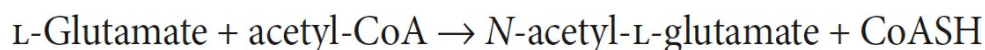

While the clinical and biochemical features of NAGS deficiency are indistinguishable from those arising from a defect in carbamoyl phosphate synthetase I, a deficiency in NAGS may respond to administered *N*-acetylglutamate.

Ornithine Permease

The hyperornithinemia, hyperammonemia, and homocitrullinuria (**HHH**) syndrome results from mutation of the *ORNT1* gene that encodes the mitochondrial membrane ornithine permease. The failure to import cytosolic ornithine into the mitochondrial matrix renders the urea cycle inoperable, with consequent hyperammonemia, and hyperornithinemia due to the accompanying accumulation of cytosolic ornithine. In the absence of its normal acceptor (ornithine), mitochondrial carbamoyl phosphate carbamoylates lysine to homocitrulline, resulting in homocitrullinuria.

Ornithine Transcarbamoylase

The X-chromosome–linked deficiency termed “hyperammonemia type 2” reflects a defect in ornithine transcarbamoylase (reaction 2, [Figure 28–16](#)). The mothers also exhibit hyperammonemia and an aversion to high-protein foods. Levels of glutamine are elevated in blood, cerebrospinal fluid, and urine, probably as a result of enhanced glutamine synthesis in response to elevated levels of tissue ammonia.

Argininosuccinate Synthetase

In addition to patients who lack detectable argininosuccinate synthetase activity (reaction 3, [Figure 28–16](#)), a 25-fold elevated K_m for citrulline has been reported. In the resulting citrullinemia, plasma and cerebrospinal fluid citrulline levels are elevated, and 1 to 2 g of citrulline are excreted daily.

Argininosuccinate Lyase

Argininosuccinic aciduria, accompanied by elevated levels of argininosuccinate in blood, cerebrospinal fluid, and urine, is associated with friable, tufted hair (trichorhexis nodosa). Both early- and late-onset types are known. The metabolic defect is in argininosuccinate lyase (reaction 4, [Figure 28–16](#)). Diagnosis by the measurement of erythrocyte argininosuccinate lyase activity can be performed on umbilical cord blood or amniotic fluid cells.

Arginase

Hyperargininemia is an autosomal recessive defect in the gene for arginase (reaction 5, [Figure 28–16](#)). Unlike other urea cycle disorders, the first symptoms of hyperargininemia typically do not appear until age 2 to 4 years. Blood and cerebrospinal fluid levels of arginine are elevated. The urinary amino acid pattern, which resembles that of lysine-cystinuria (see [Chapter 29](#)), may reflect competition by arginine with lysine and cysteine for reabsorption in the renal tubule.

Analysis of Neonate Blood by Tandem Mass Spectrometry Can Detect Metabolic Diseases

Metabolic diseases caused by the absence or functional impairment of metabolic enzymes can be devastating. Early dietary intervention, however, can in many instances ameliorate the otherwise inevitable dire effects. The early detection of such metabolic diseases is thus of primary importance. Since the initiation in the United States of newborn screening programs in the 1960s, all states now conduct metabolic screening of newborn infants. The powerful and sensitive technique of **tandem mass spectrometry** (MS) (see [Chapter 4](#)) can in a few minutes detect over 40 analytes of significance in the detection of metabolic disorders. Most states employ tandem MS to screen newborns to detect metabolic disorders such

as organic acidemias, aminoacidemias, disorders of fatty acid oxidation, and defects in the enzymes of the urea cycle. An article in *Clinical Chemistry* 2006 39:315 reviews the theory of tandem MS, its application to the detection of metabolic disorders, and situations that can yield false positives, and includes a lengthy table of detectable analytes and the relevant metabolic diseases.

Can Metabolic Disorders Be Rectified by Gene or Protein Modification

Despite results in animal models using an adenoviral vector to treat citrullinemia, at present gene therapy provides no effective solution for human subjects. However, direct CRISPR/Cas9-based modification of a defective enzyme can restore functional enzyme activity of cultured human pluripotent stem cells.

SUMMARY

- Human subjects degrade 1 to 2% of their body protein daily at rates that vary widely between proteins and with physiologic state. Key regulatory enzymes often have short half-lives.
- Proteins are degraded by both ATP-dependent and ATP-independent pathways. Ubiquitin targets many intracellular proteins for degradation. Liver cell surface receptors bind and internalize circulating asialoglycoproteins destined for lysosomal degradation.
- Polyubiquitinated proteins are degraded by proteases on the inner surface of a cylindrical macromolecule, the proteasome. Entry into the proteasome is gated by a donut-shaped protein pore that rejects entry to all but polyubiquitinated proteins.
- Fishes excrete highly toxic NH_3 directly. Birds convert NH_3 to uric acid. Higher vertebrates convert NH_3 to urea.
- Transamination channels amino acid nitrogen into glutamate. GDH occupies a central position in nitrogen metabolism.
- Glutamine synthetase converts NH_3 to nontoxic glutamine. Glutaminase releases NH_3 for use in urea synthesis.
- NH_3 , CO_2 , and the amide nitrogen of aspartate provide the atoms of urea.
- Hepatic urea synthesis takes place in part in the mitochondrial matrix and in part in the cytosol.

- Changes in enzyme levels and allosteric regulation of carbamoyl phosphate synthetase I by *N*-acetylglutamate regulate urea biosynthesis.
- Metabolic diseases are associated with defects in each enzyme of the urea cycle, of the membrane-associated ornithine permease, and of NAGS.
- The metabolic disorders of urea biosynthesis illustrate six general principles of all metabolic disorders.
- Tandem mass spectrometry is the technique of choice for screening neonates for inherited metabolic diseases.

REFERENCES

- Adam S, Almeida MF, Assoun M et al: Dietary management of urea cycle disorders: European practice. *Mol Genet Metab* 2013;110:439.
- Burgard P, Kölker S, Haege G, et al. Neonatal mortality and outcome at the end of the first year of life in early onset urea cycle disorders. *J Inherit Metab Dis*. 2016;39:219.
- Dwane L, Gallagher WM, Ni Chonghaile T, et al: The emerging role of non-traditional ubiquitination in oncogenic pathways. *J Biol Chem* 2017;292:3543.
- Häberle J, Pauli S, Schmidt E, et al: Mild citrullinemia in caucasians is an allelic variant of argininosuccinate synthetase deficiency (citrullinemia type 1). *Mol Genet Metab* 2003;80:302.
- Jiang YH, Beaudet AL: Human disorders of ubiquitination and proteasomal degradation. *Curr Opin Pediatr* 2004;16:419.
- Monné M, Miniero DV, Dabbabbo L, et al: Mitochondrial transporters for ornithine and related amino acids: a review. *Amino Acids* 2015;9:1963.
- Pal A, Young MA, Donato NJ: Emerging potential of therapeutic targeting of ubiquitin-specific proteases in the treatment of cancer. *Cancer Res* 2014;14:721.
- Pickart CM: Mechanisms underlying ubiquitination. *Annu Rev Biochem* 2001;70:503.
- Sylvestersen KB, Young C, Nielsen ML: Advances in characterizing ubiquitylation sites by mass spectrometry. *Curr Opin Chem Biol* 2013;17:49.
- Waisbren SE, Gropman AL: Improving long term outcomes in urea cycle disorders. *J Inherit Metab Dis* 2016;39:573.

Catabolism of the Carbon Skeletons of Amino Acids

Victor W. Rodwell, PhD

OBJECTIVES

After studying this chapter, you should be able to:

- Name the principal catabolites of the carbon skeletons of the protein amino acids and the major metabolic fates of these catabolites.
- Write an equation for an aminotransferase (transaminase) reaction and illustrate the role played by the coenzyme.
- Outline the metabolic pathways for each of the protein amino acids, and identify reactions associated with clinically significant metabolic disorders.
- Provide examples of aminoacidurias that arise from defects in glomerular tubular reabsorption, and the consequences of impaired intestinal absorption of tryptophan.
- Explain why metabolic defects in different enzymes of the catabolism of a specific amino acid can be associated with similar clinical signs and symptoms.
- Describe the implications of a metabolic defect in Δ^1 -pyrroline-5-

carboxylate dehydrogenase for the catabolism of proline and of 4-hydroxyproline.

- Explain how the α -amino nitrogen of proline and of lysine is removed by processes other than transamination.
- Draw analogies between the reactions that participate in the catabolism of fatty acids and of the branched-chain amino acids.
- Identify the specific metabolic defects in hypervalinemia, maple syrup urine disease, intermittent branched-chain ketonuria, isovaleric acidemia, and methylmalonic aciduria.

BIOMEDICAL IMPORTANCE

Chapter 28 described the removal by transamination and the metabolic fate of the nitrogen atoms of most of the protein L- α -amino acids. This chapter addresses the metabolic fates of the resulting hydrocarbon skeletons of each of the protein amino acids, the enzymes and intermediates involved, and several associated metabolic diseases or “inborn errors of metabolism.” Most disorders of amino acid catabolism are rare, but if left untreated, they can result in irreversible brain damage and early mortality. Prenatal or early postnatal detection of metabolic disorders and timely initiation of treatment thus are essential. The ability to detect the activities of enzymes in cultured amniotic fluid cells facilitates prenatal diagnosis by amniocentesis. In the United States, all states conduct screening tests of newborns for up to 40 metabolic diseases, including disorders associated with defects in the catabolism of amino acids. The most reliable screening tests use tandem mass spectrometry to detect, in a few drops of neonate blood, catabolites suggestive of a given metabolic defect, and thereby implicate the absence or lowered activity of one or more specific enzymes.

Mutations either of a gene or of associated regulatory regions of DNA can result either in the failure to synthesize the encoded enzyme or in synthesis of a partially or completely nonfunctional enzyme. Mutations that affect enzyme activity, those that compromise its three-dimensional structure, or that disrupt its catalytic or regulatory sites, can have severe metabolic consequences. Low catalytic efficiency of a mutant enzyme can result from impaired positioning of residues involved in catalysis, or in binding a substrate, coenzyme, or metal ion. Mutations may also impair the ability of certain enzymes to respond appropriately to the signals that modulate their activity by altering an enzyme’s affinity for an allosteric regulator of activity. Since different mutations can have similar effects on

any of the above factors, various mutations may give rise to the same clinical signs and symptoms. At a molecular level, these, therefore, are distinct molecular diseases. Present treatment of metabolic disorders of amino acid metabolism consists primarily of feeding diets low in the amino acid whose catabolism is impaired. Ultimately, however, genetic engineering may be able to permanently correct a given metabolic defect.

AMINO ACIDS ARE CATABOLIZED TO INTERMEDIATES FOR CARBOHYDRATE AND LIPID BIOSYNTHESIS

Nutritional studies in the period 1920 to 1940, reinforced and confirmed by studies using isotopically labeled amino acids conducted from 1940 to 1950, established the interconvertibility of the carbon atoms of fat, carbohydrate, and protein. These studies also revealed that all or a portion of the carbon skeleton of every amino acid is convertible either to carbohydrate, fat, or both fat and carbohydrate (**Table 29–1**). **Figure 29–1** outlines overall aspects of these interconversions.

TABLE 29–1 Fate of the Carbon Skeletons of the Protein L- α -Amino Acids

Converted to Amphibolic Intermediates That Form			
	Carbohydrate (Glycogenic)	Fat (Ketogenic)	Glycogen and Fat (Glycogenic and Ketogenic)
Ala	Hyp	Leu	Ile
Arg	Met	Lys	Phe
Asp	Pro		Trp
Cys	Ser		Tyr
Glu	Thr		
Gly	Val		
His			

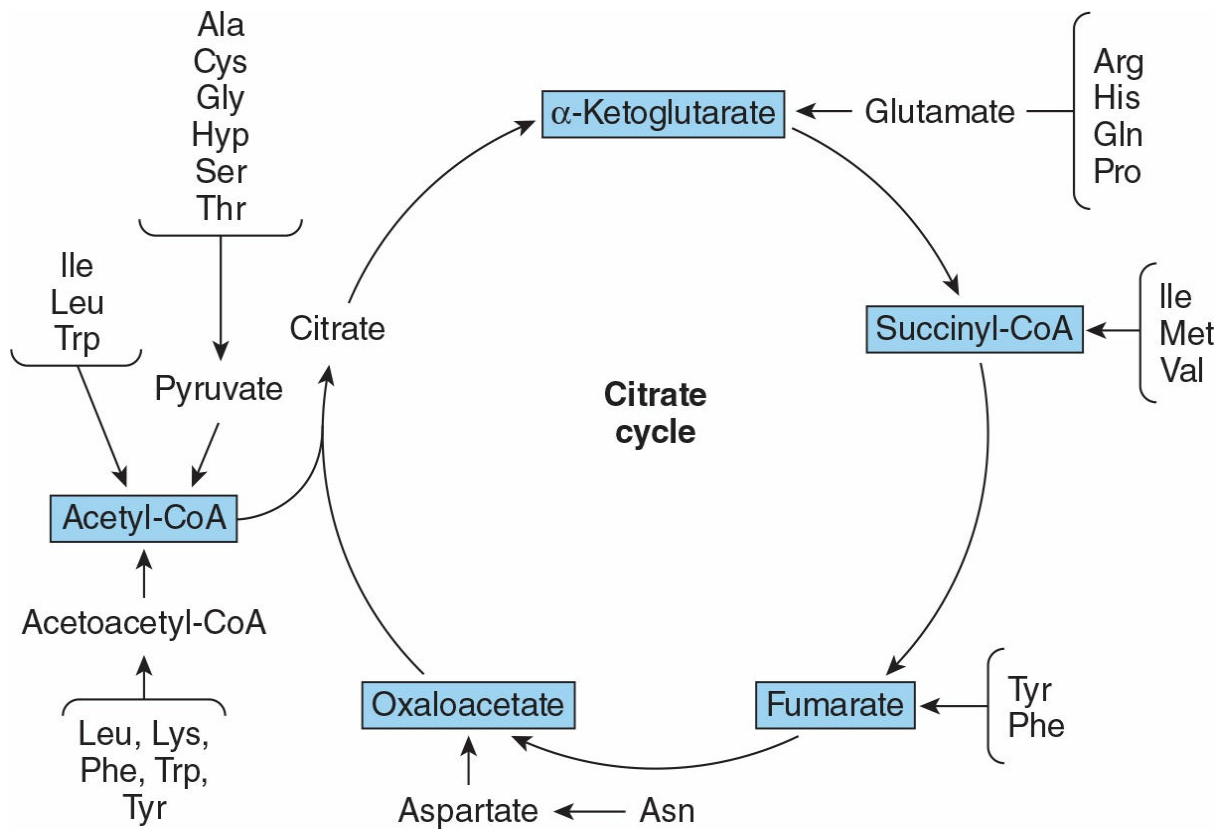

FIGURE 29–1 Overview of the amphibolic intermediates that result from catabolism of the protein amino acids.

TRANSAMINATION TYPICALLY INITIATES AMINO ACID CATABOLISM

Removal of α -amino nitrogen by transamination, catalyzed by a transaminase (see Figure 28–9), is the first catabolic reaction of most of the protein amino acids. The exceptions are proline, hydroxyproline, threonine, and lysine, whose α -amino groups do not participate in transamination. The hydrocarbon skeletons that remain are then degraded to amphibolic intermediates as outlined in Figure 29–1.

Asparagine & Aspartate Form Oxaloacetate

All four carbons of asparagine and of aspartate form **oxaloacetate** via reactions catalyzed by **asparaginase** (EC 3.5.1.1) and a **transaminase**.

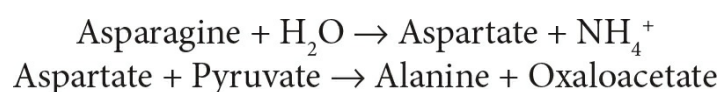

Glutamine & Glutamate Form α -Ketoglutarate

Successive reactions catalyzed by **glutaminase** (EC 3.5.1.2) and a **transaminase** form **α -ketoglutarate**

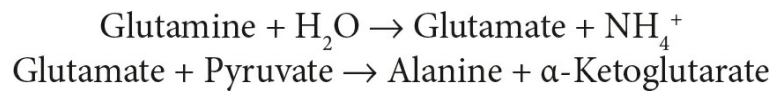

While both glutamate and aspartate are substrates for the same transaminase, metabolic defects in transaminases, which fulfill central amphibolic functions, may be incompatible with life. Consequently, no known metabolic defect is associated with these two short catabolic pathways that convert asparagine and glutamine to amphibolic intermediates.

Proline

The catabolism of proline takes place in mitochondria. Since proline does not participate in transamination, its α -amino nitrogen is retained throughout a two-stage oxidation to glutamate. Oxidation to Δ^1 -pyrroline-5-carboxylate is catalyzed by proline dehydrogenase, EC 1.5.5.2.

Subsequent oxidation to glutamate is catalyzed by Δ^1 -pyrroline-5-carboxylate dehydrogenase (also called glutamate- γ -semialdehyde dehydrogenase, EC 1.2.1.88) (**Figure 29–2**). There are two metabolic disorders of proline catabolism. Inherited as autosomal recessive traits, both are consistent with a normal adult life. The metabolic block in **type I hyperprolinemia** is at **proline dehydrogenase**. There is no associated impairment of hydroxyproline catabolism. The metabolic block in **type II hyperprolinemia** is at Δ^1 -pyrroline-5-carboxylate dehydrogenase, which also participates in the catabolism of arginine, ornithine, and hydroxyproline (see below). Since proline and hydroxyproline catabolism are affected, both Δ^1 -pyrroline-5-carboxylate and Δ^1 -pyrroline-3-hydroxy-5-carboxylate (see **Figure 29–11**) are excreted.

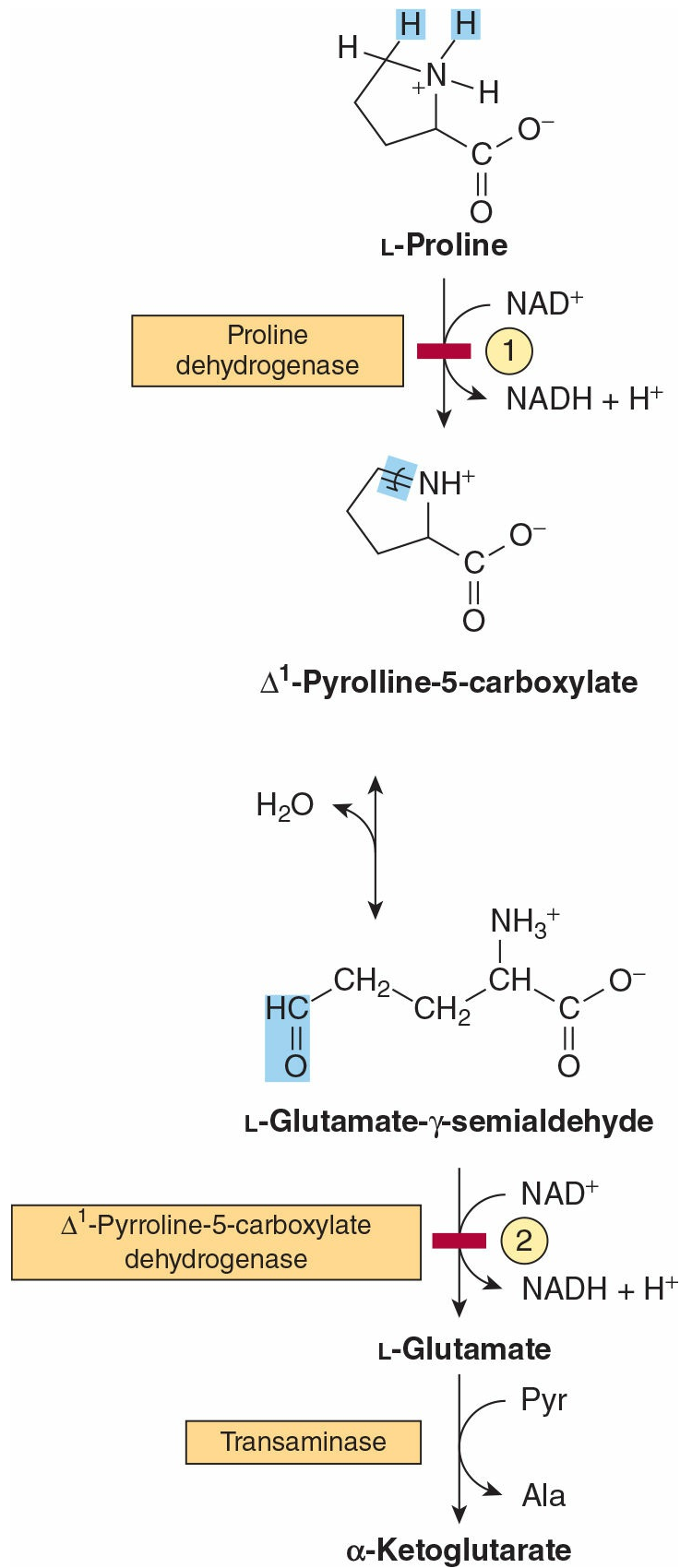

FIGURE 29–2 Catabolism of proline. Red bars and circled numerals indicate the locus of the inherited metabolic defects in ① type-I

hyperprolinemia and ② type-II hyperprolinemia. In this and subsequent figures, blue highlights emphasize the portions of the molecules that are undergoing chemical change.

Arginine & Ornithine

The initial reactions in arginine catabolism are conversion to ornithine followed by transamination of ornithine to glutamate- γ -semialdehyde (**Figure 29–3**). Subsequent catabolism of glutamate- γ -semialdehyde to α -ketoglutarate occurs as described for proline (**Figure 29–2**). Mutations in **ornithine δ -aminotransferase** (ornithine transaminase, EC 2.6.1.13) elevate plasma and urinary ornithine, and are associated with **gyrate atrophy of the choroid and retina**. Treatment involves restricting dietary arginine. In the **hyperornithinemia–hyperammonemia syndrome**, a defective mitochondrial **ornithine-citrulline antiporter** (see **Figure 28–16**) impairs transport of ornithine into mitochondria, where it participates in urea synthesis.

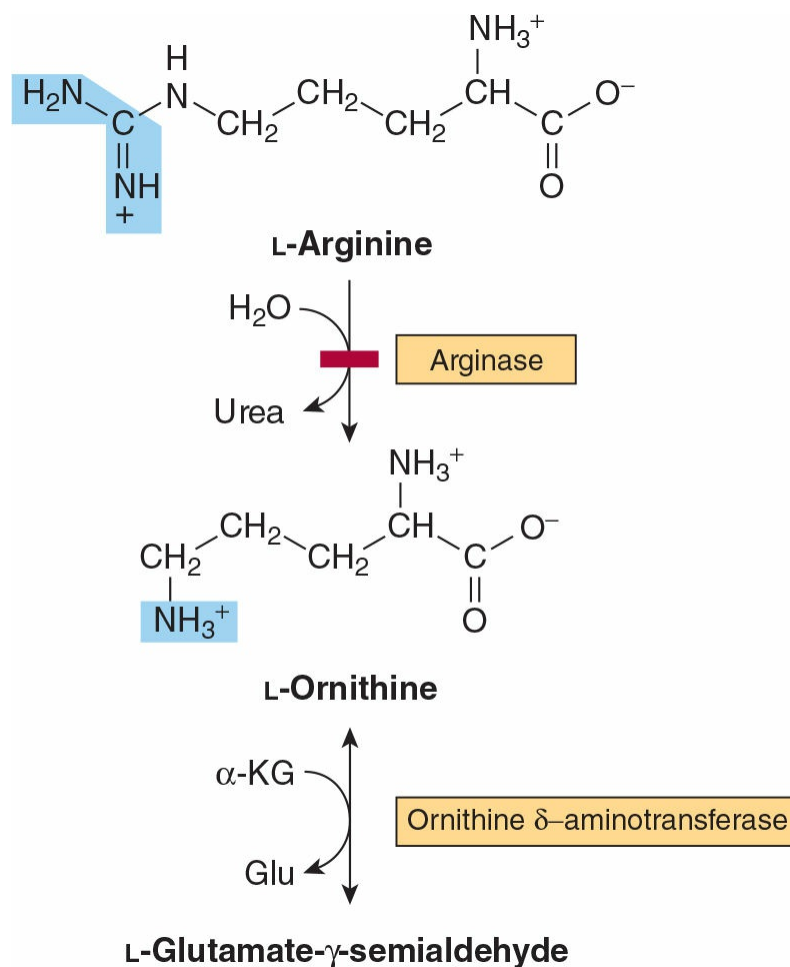

FIGURE 29–3 Catabolism of arginine. Arginase-catalyzed cleavage of

L-arginine forms urea and L-ornithine. This reaction (red bar) represents the site of the inherited metabolic defect in hyperargininemia. Subsequent transamination of ornithine to glutamate- γ -semialdehyde is followed by its oxidation to α -ketoglutarate.

Histidine

Catabolism of histidine proceeds via urocanate, 4-imidazolone-5-propionate, and *N*-formiminoglutamate (Figlu). Formimino group transfer to tetrahydrofolate forms glutamate, then α -ketoglutarate (Figure 29–4). In **follic acid deficiency**, transfer of the formimino group is impaired, and Figlu is excreted. Excretion of Figlu following a dose of histidine thus can be used to detect folic acid deficiency. Benign disorders of histidine catabolism include **histidinemia** and **urocanic aciduria** associated with impaired **histidase**.

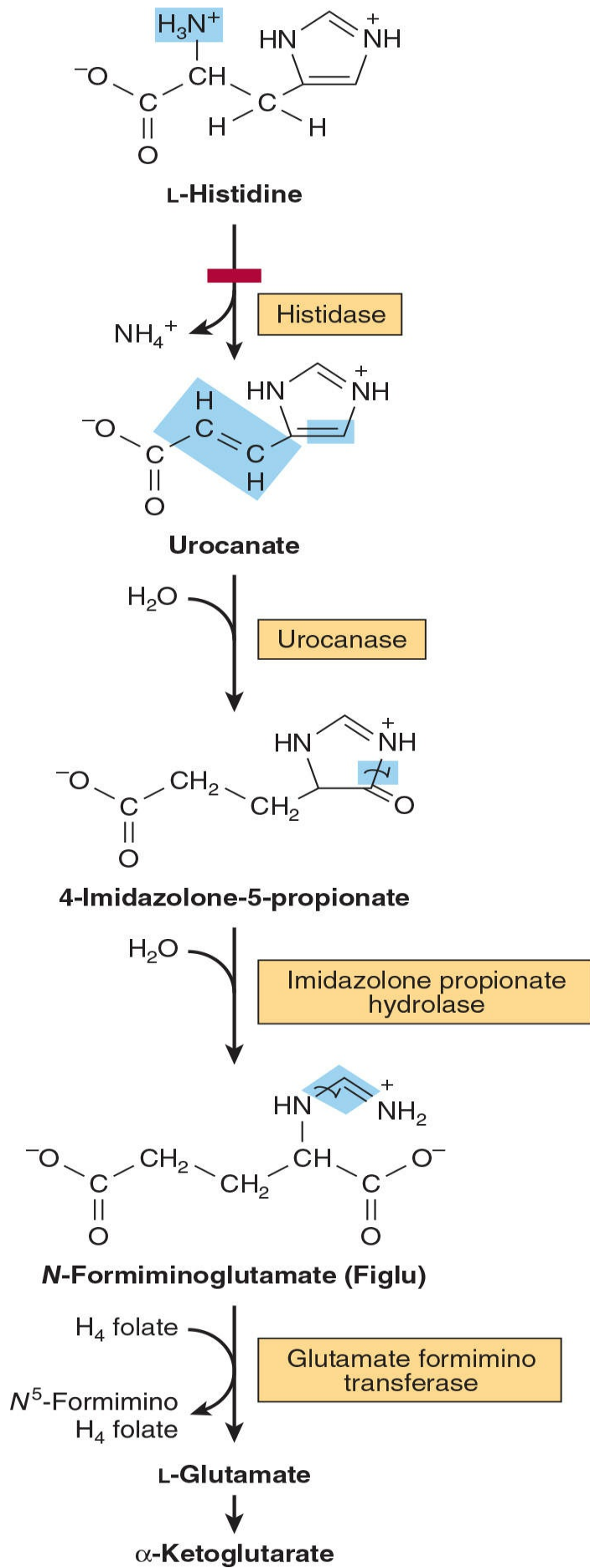
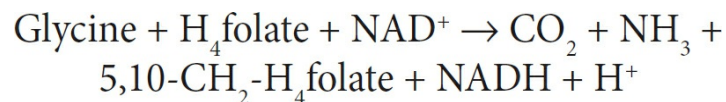

FIGURE 29–4 Catabolism of L-histidine to α -ketoglutarate. (H_4 folate, tetrahydrofolate.) The red bar indicates the site of an inherited metabolic defect.

CATABOLISM OF GLYCINE, SERINE, ALANINE, CYSTEINE, THREONINE, & 4-HYDROXYPROLINE

Glycine

The **glycine cleavage complex** of liver mitochondria splits glycine to CO_2 and NH_4^+ and forms N^5,N^{10} -methylene tetrahydrofolate.



The glycine cleavage system (**Figure 29–5**) consists of three enzymes and an “H-protein” that has a covalently attached dihydrolipoyl moiety. **Figure 29–5** also illustrates the individual reactions and intermediates in glycine cleavage. In **nonketotic hyperglycinemia**, a rare inborn error of glycine degradation, glycine accumulates in all body tissues including the central nervous system. The defect in **primary hyperoxaluria** is the failure to catabolize glyoxylate formed by the deamination of glycine. Subsequent oxidation of glyoxylate to oxalate results in urolithiasis, nephrocalcinosis, and early mortality from renal failure or hypertension. **Glycinuria** results from a defect in renal tubular reabsorption.

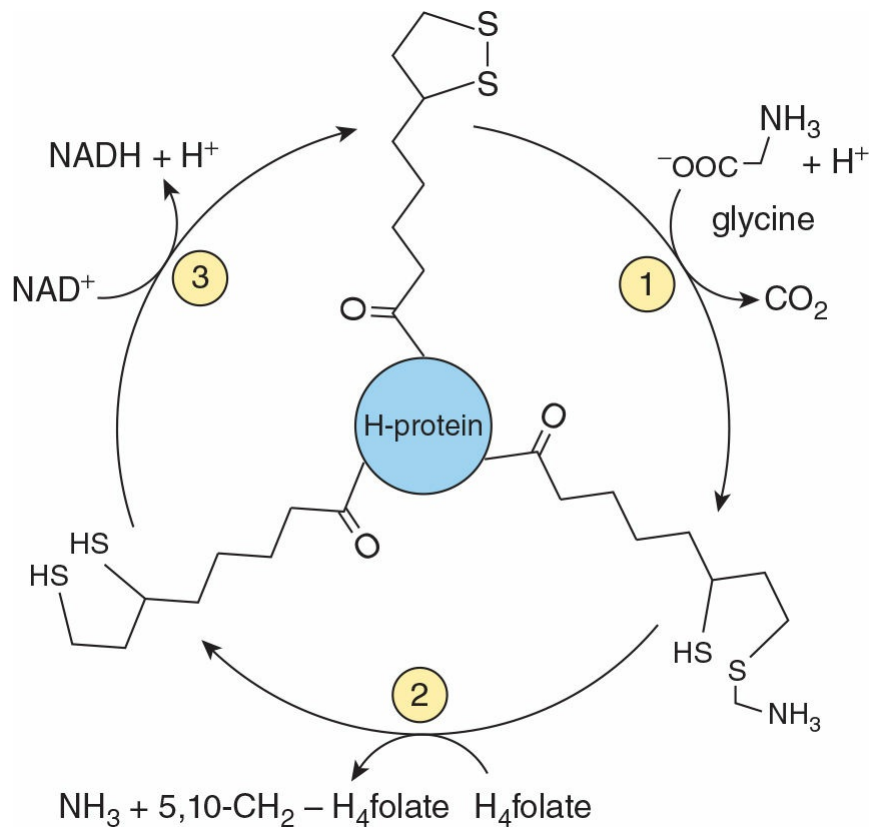

FIGURE 29–5 The glycine cleavage system of liver mitochondria. The glycine cleavage complex consists of three enzymes and an “H-protein” that has covalently attached dihydropyridine. Catalysts for the numbered reactions are ① glycine dehydrogenase (decarboxylating), ② an ammonia-forming aminomethyltransferase, and ③ dihydropyridinamide dehydrogenase. (H_4 folate, tetrahydrofolate).

Serine

Following conversion to glycine, catalyzed by glycine hydroxymethyltransferase (EC 2.1.2.1), serine catabolism merges with that of glycine (**Figure 29–6**).

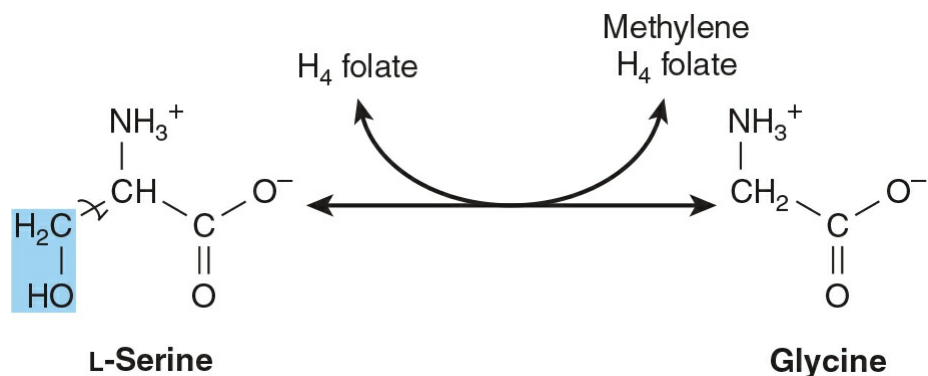

FIGURE 29–6 Interconversion of serine and glycine by glycine hydroxymethyltransferase. (H₄ folate, tetrahydrofolate.)

Alanine

Transamination of α-alanine forms pyruvate. Probably on account of its central role in metabolism, there is no known metabolic defect of α-alanine catabolism.

Cystine & Cysteine

Cystine is first reduced to cysteine by **cystine reductase**, EC 1.8.1.6 (**Figure 29–7**). Two different pathways then convert cysteine to pyruvate (**Figure 29–8**). There are numerous abnormalities of cysteine metabolism. Cystine, lysine, arginine, and ornithine are excreted in **cystine-lysinuria (cystinuria)**, a defect in renal reabsorption of these amino acids. Apart from cystine calculi, cystinuria is benign. The mixed disulfide of L-cysteine and L-homocysteine (**Figure 29–9**) excreted by cystinuric patients is more soluble than cystine and reduces formation of cystine calculi.

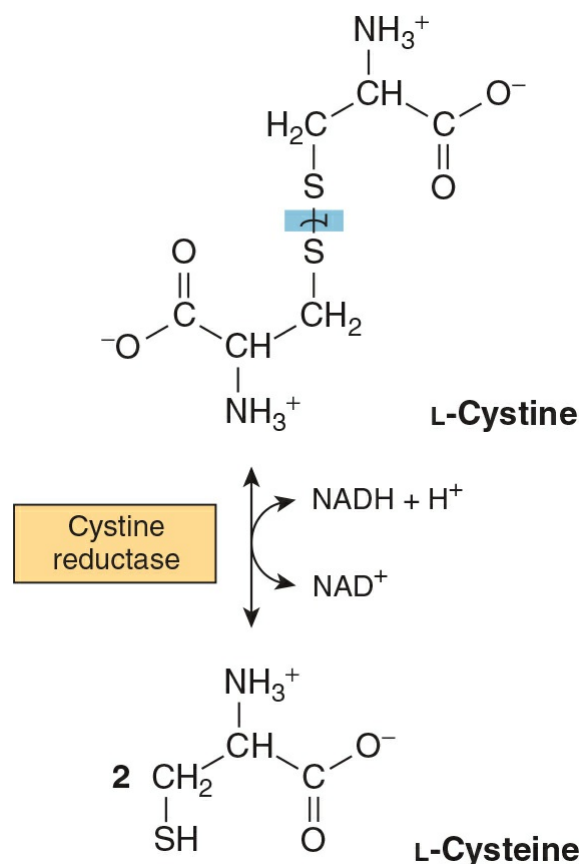

FIGURE 29–7 Reduction of cystine to cysteine by cystine reductase.

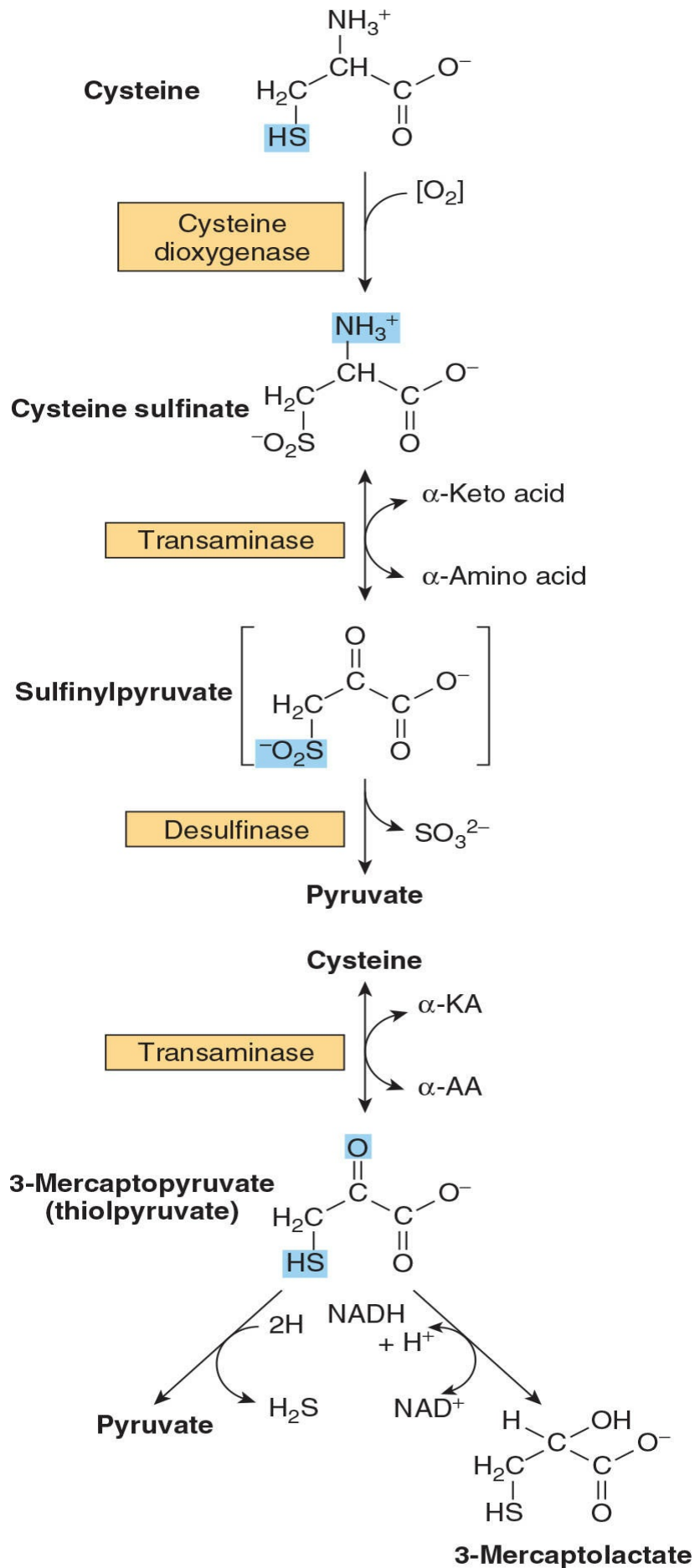

FIGURE 29–8 Two pathways catabolize cysteine: the cysteine sulfinic pathway (*top*) and the 3-mercaptopyruvate pathway (*bottom*).

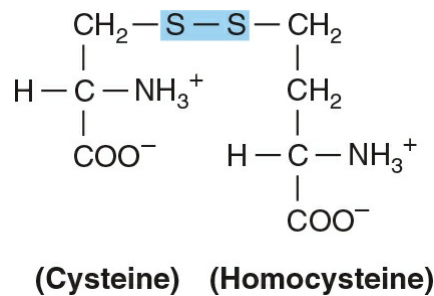
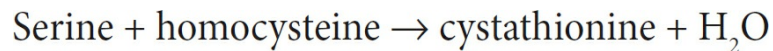

FIGURE 29–9 Structure of the mixed disulfide of cysteine and homocysteine.

Several metabolic defects result in vitamin B₆-responsive or vitamin B₆-unresponsive **homocystinurias**. These include a deficiency in the reaction catalyzed by cystathionine β-synthase, EC 4.2.1.22:



Consequences include osteoporosis and mental retardation. Defective carrier-mediated transport of cystine results in **cystinosis (cystine storage disease)** with deposition of cystine crystals in tissues and early mortality from acute renal failure. Epidemiologic and other data link plasma homocysteine levels to cardiovascular risk, but the role of homocysteine as a causal cardiovascular risk factor remains controversial.

Threonine

Threonine aldolase (EC 4.1.2.5) cleaves threonine to glycine and acetaldehyde. Catabolism of glycine is discussed above. Oxidation of acetaldehyde to acetate is followed by formation of acetyl-CoA (**Figure 29–10**).

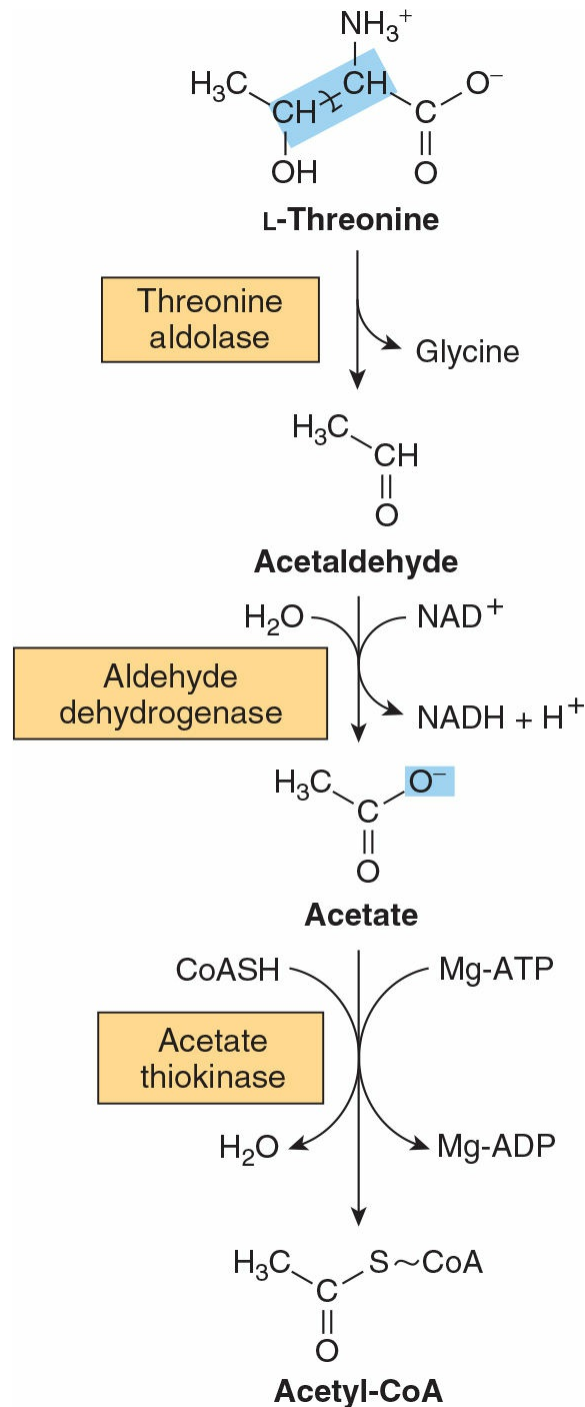
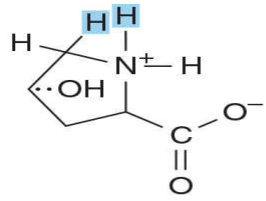

FIGURE 29–10 Intermediates in the conversion of threonine to glycine and acetyl-CoA.

4-Hydroxyproline

Catabolism of 4-hydroxy-L-proline forms, successively, L- Δ^1 -pyrroline-3-hydroxy-5-carboxylate, γ -hydroxy-L-glutamate- γ -semialdehyde, erythro- γ -hydroxy-L-glutamate, and α -keto- γ -hydroxyglutarate. An aldol-type cleavage then forms glyoxylate plus pyruvate (**Figure 29–11**). A defect in

4-hydroxyproline dehydrogenase results in **hyperhydroxyprolinemia**, which is benign. There is no associated impairment of proline catabolism. A defect in **glutamate- γ -semialdehyde dehydrogenase** is accompanied by excretion of Δ^1 -pyrroline-3-hydroxy-5-carboxylate.



4-Hydroxy-L-proline

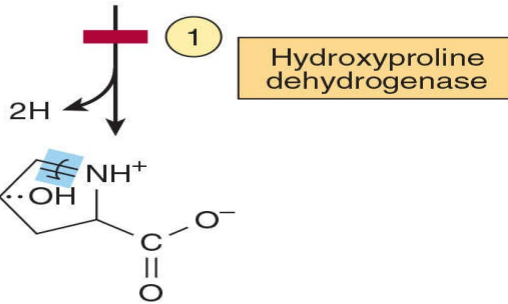

L- Δ^1 -Pyrroline-3-hydroxy-5-carboxylate

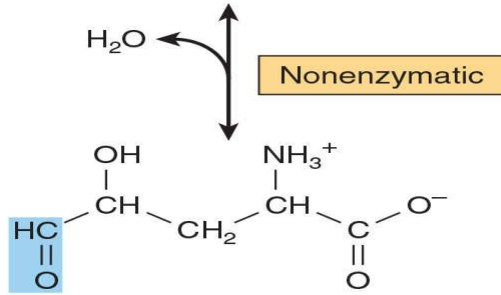

γ -Hydroxy-L-glutamate- γ -semialdehyde

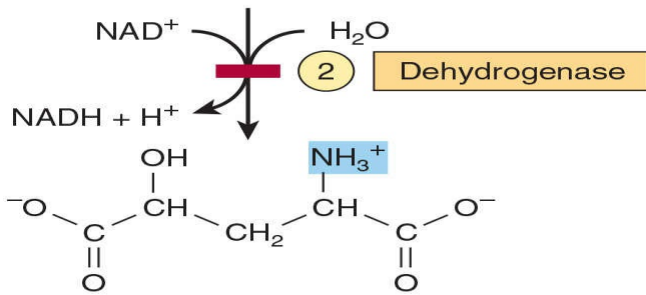

Erythro- γ -hydroxy-L-glutamate

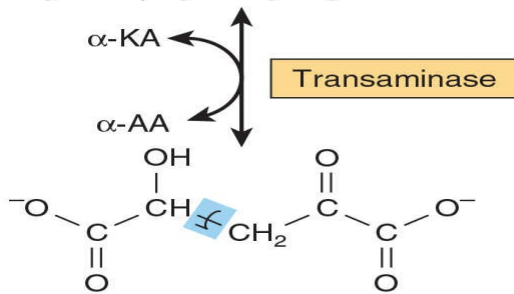

α -Keto- γ -hydroxyglutarate

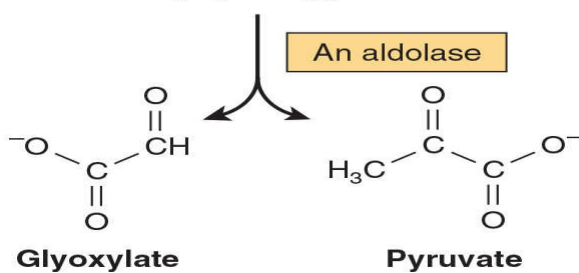

Glyoxylate

Pyruvate

FIGURE 29–11 Intermediates in hydroxyproline catabolism. (α -AA, α -amino acid; α -KA, α -keto acid.) Red bars indicate the sites of the inherited metabolic defects in ① hyperhydroxyprolinemia and ② type II hyperprolinemia.

ADDITIONAL AMINO ACIDS THAT FORM ACETYL-CoA

Tyrosine

Figure 29–12 illustrates the intermediates and enzymes that participate in the catabolism of tyrosine to amphibolic intermediates. Following transamination of tyrosine to *p*-hydroxyphenylpyruvate, successive reactions form homogentisate, maleylacetoacetate, fumarylacetoacetate, fumarate, acetoacetate, and ultimately acetyl-CoA and acetate.

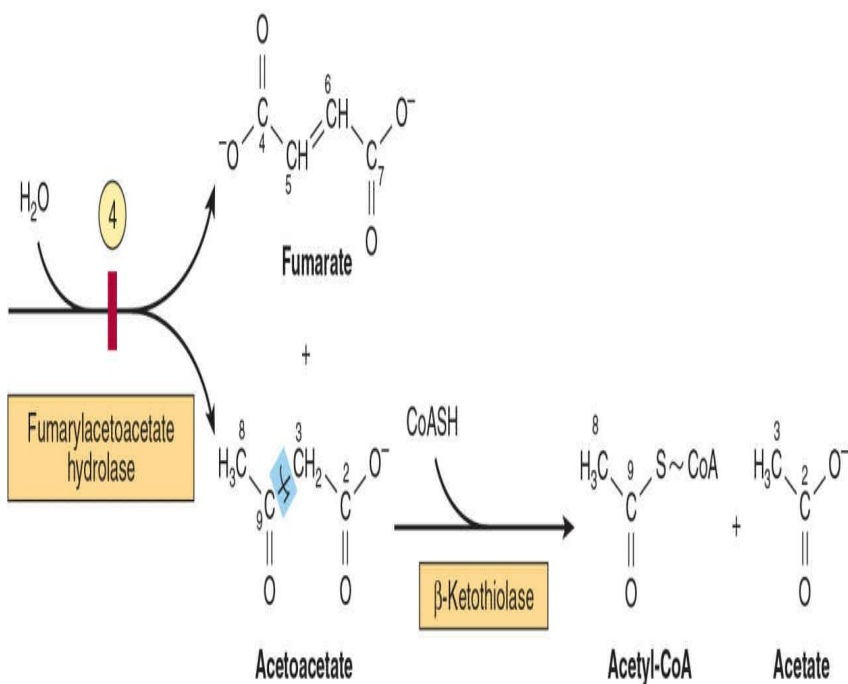
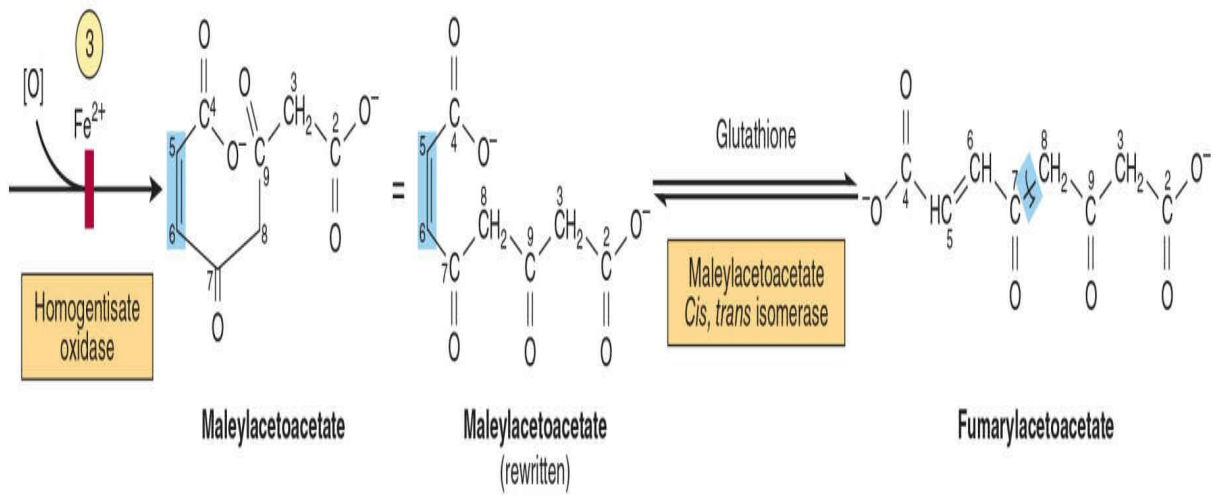
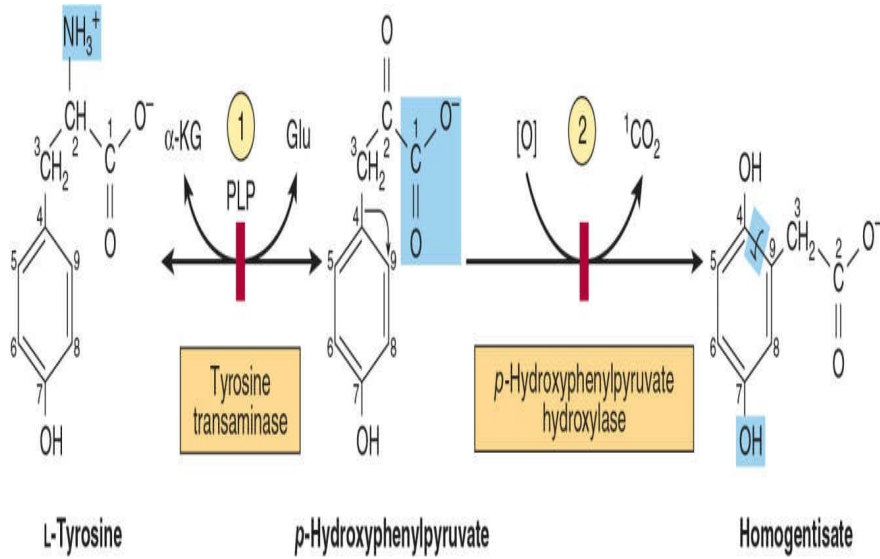

FIGURE 29–12 Intermediates in tyrosine catabolism. Carbons are numbered to emphasize their ultimate fate. (α -KG, α -ketoglutarate; Glu, glutamate; PLP, pyridoxal phosphate.) Red bars indicate the probable sites of the inherited metabolic defects in type II tyrosinemia; neonatal tyrosinemia; ① alkaptonuria; and ② type I tyrosinemia, or tyrosinosis. ③ alkaptonuria; and ④ type I tyrosinemia, or tyrosinosis.

Several metabolic disorders are associated with the tyrosine catabolic pathway. The probable metabolic defect in **type I tyrosinemia (tyrosinosis)** is at **fumarylacetoacetate hydrolase**, EC 3.7.1.12 (reaction 4, [Figure 29–12](#)). Therapy employs a diet low in tyrosine and phenylalanine. Untreated acute and chronic tyrosinosis leads to death from liver failure. Alternate metabolites of tyrosine are also excreted in **type II tyrosinemia (Richner-Hanhart syndrome)**, a defect in **tyrosine aminotransferase** (reaction 1, [Figure 29–12](#)), and in **neonatal tyrosinemia**, due to lowered activity of *p*-hydroxyphenylpyruvate hydroxylase, EC 1.13.11.27 (reaction 2, [Figure 29–12](#)). Therapy employs a diet low in protein.

The metabolic defect in **alkaptonuria** is a defective **homogentisate oxidase** (EC 1.13.11.5), the enzyme that catalyzes reaction 3 of [Figure 29–12](#). The urine darkens on exposure to air due to oxidation of excreted homogentisate. Late in the disease, there is arthritis and connective tissue pigmentation (ochronosis) due to oxidation of homogentisate to benzoquinone acetate, which polymerizes and binds to connective tissue. First described in the 16th century based on the observation that the urine darkened on exposure to air, alkaptonuria provided the basis for Sir Archibald Garrod's early 20th century classic ideas concerning heritable metabolic disorders. Based on the presence of ochronosis and on chemical evidence, the earliest known case of alkaptonuria is, however, its 1977 detection in an Egyptian mummy dating from 1500 B.C.

Phenylalanine

Phenylalanine is first converted to tyrosine (see [Figure 27–12](#)). Subsequent reactions are those of tyrosine ([Figure 29–12](#)). **Hyperphenylalaninemias** arise from defects in phenylalanine hydroxylase, EC 1.14.16.1 (**type I, classic phenylketonuria [PKU]**, frequency 1 in 10,000 births), in dihydrobiopterin reductase (**types II and III**), or in dihydrobiopterin biosynthesis (**types IV and V**) (see [Figure 27–12](#)). Alternative catabolites

are excreted (**Figure 29–13**). A diet low in phenylalanine can prevent the mental retardation of PKU.

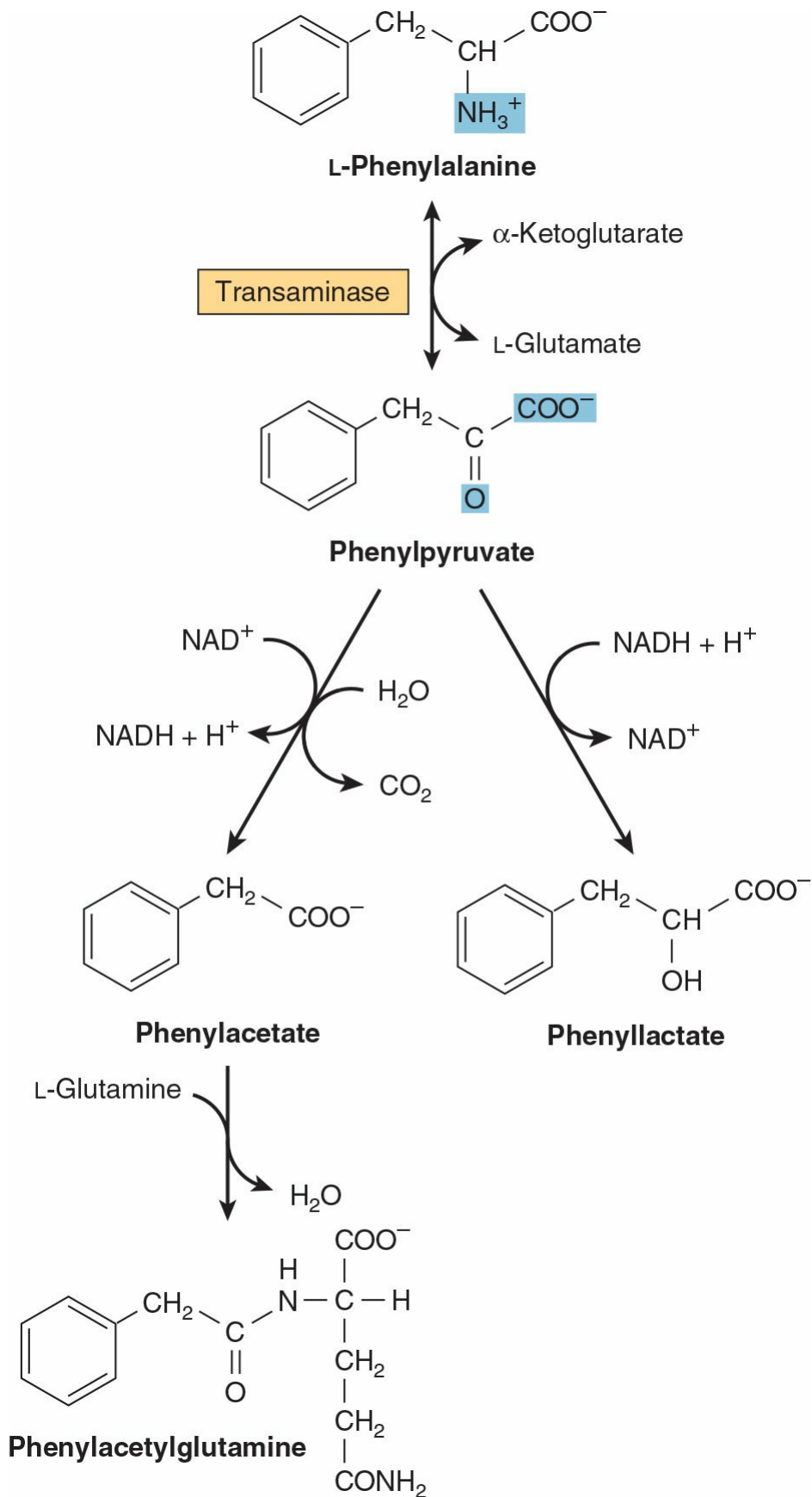

FIGURE 29–13 Alternative pathways of phenylalanine catabolism in phenylketonuria. The reactions also occur in normal liver tissue but are of minor significance.

DNA probes facilitate prenatal diagnosis of defects in phenylalanine hydroxylase or dihydrobiopterin reductase. Elevated blood phenylalanine may not be detectable until 3 to 4 days postpartum. False positives in premature infants may reflect delayed maturation of enzymes of phenylalanine catabolism. An older and less reliable screening test employs FeCl_3 to detect urinary phenylpyruvate. FeCl_3 screening for PKU of the urine of newborn infants is compulsory in many countries, but in the United States has been largely supplanted by tandem mass spectrometry.

Lysine

Removal of the ϵ -nitrogen of lysine proceeds via initial formation of **saccharopine** and subsequent reactions that also liberate the α -nitrogen. The ultimate product of the carbon skeleton is crotonyl-CoA. Circled numerals refer to the corresponding numbered reactions of **Figure 29–14**. Reactions 1 and 2 convert the Schiff base formed between α -ketoglutarate and the ϵ -amino group of lysine to L- α -aminoadipate- δ -semialdehyde. Reactions 1 and 2 both are catalyzed by a single bifunctional enzyme, aminoadipate- δ -semialdehyde synthase (EC 1.5.1.8) whose *N*-terminal and *C*-terminal domains contain lysine- α -ketoglutarate reductase and saccharopine dehydrogenase activity, respectively. Reduction of L- α -aminoadipate- δ -semialdehyde to L- α -aminoadipate (reaction 3) is followed by transamination to α -ketoadipate (reaction 4). Conversion to the thioester glutaryl-CoA (reaction 5) is followed by the decarboxylation of glutaryl-CoA to crotonyl-CoA (reaction 6). Reduction of crotonyl-CoA by crotonyl-CoA reductase, EC 1.3.1.86, forms butanoyl-CoA:

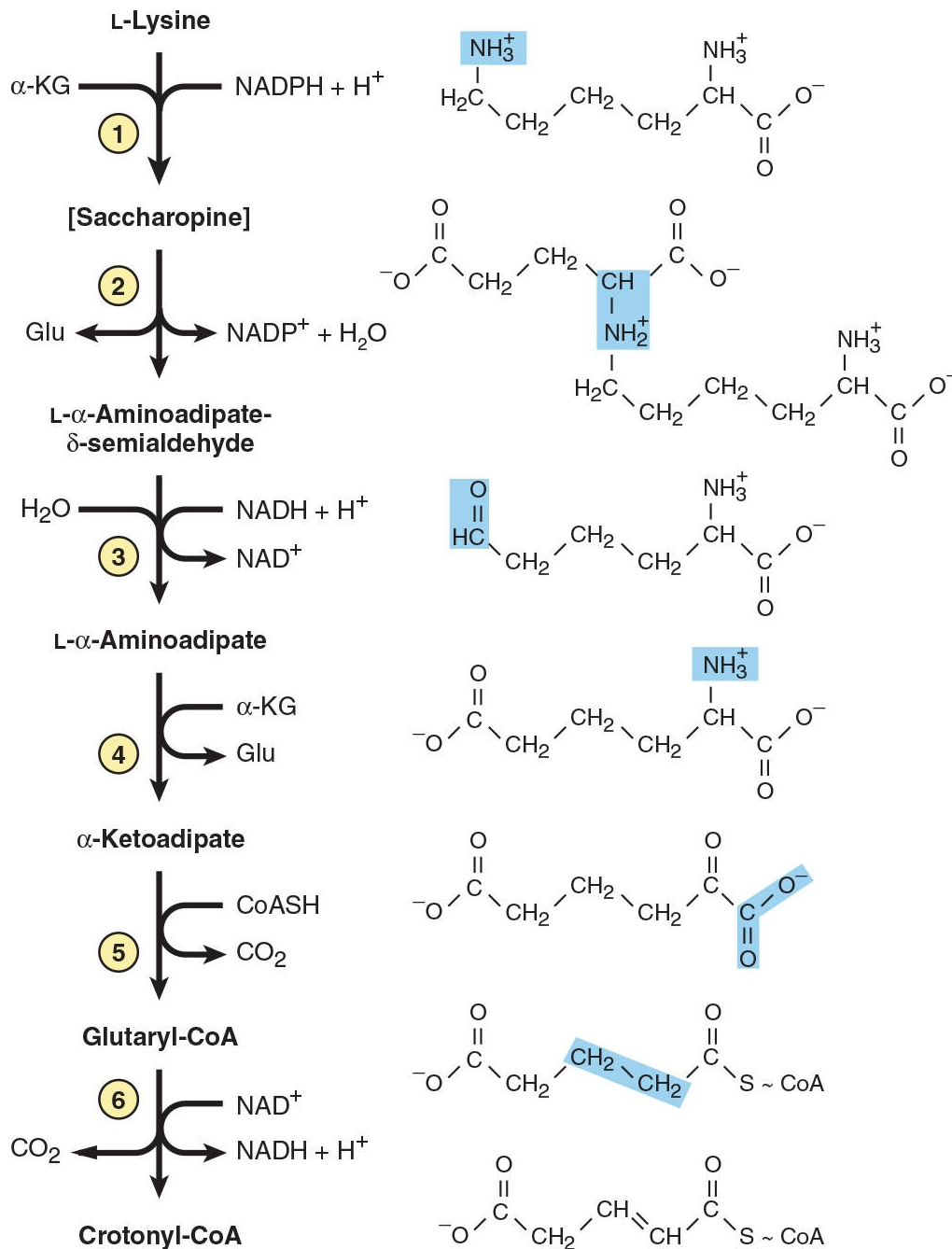
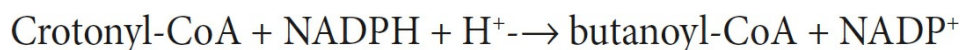

FIGURE 29–14 Reactions and intermediates in the catabolism of lysine.



Subsequent reactions are those of fatty acid catabolism (see [Chapter 22](#)).

Hyperlysinemia can result from a metabolic defect in either the first or second activity of the bifunctional enzyme amino adipate-δ-semialdehyde synthase, but this is accompanied by elevated levels of blood saccharopine only if the defect involves the second activity. A metabolic defect at reaction 6 results in an inherited metabolic disease that is associated with

striatal and cortical degeneration, and is characterized by elevated concentrations of glutarate and its metabolites glutaconate and 3-hydroxyglutarate. The challenge in management of these metabolic defects is to restrict dietary intake of L-lysine without producing malnutrition.

Tryptophan

Tryptophan is degraded to amphibolic intermediates via the kynurenine-anthranilate pathway (**Figure 29–15**). **Tryptophan 2,3-dioxygenase**, EC 1.13.11.11 (**tryptophan pyrrolase**) opens the indole ring, incorporates molecular oxygen, and forms *N*-formylkynurenine. Tryptophan oxygenase, an iron porphyrin metalloprotein that is inducible in liver by adrenal corticosteroids and by tryptophan, is feedback inhibited by nicotinic acid derivatives, including NADPH. Hydrolytic removal of the formyl group of *N*-formylkynurenine, catalyzed by **kynurenine formylase** (EC 3.5.1.9), produces kynurenine. Since **kynureninase** (EC 3.7.1.3) requires pyridoxal phosphate, excretion of xanthurenate (**Figure 29–16**) in response to a tryptophan load is diagnostic of vitamin B₆ deficiency. **Hartnup disease** reflects impaired intestinal and renal transport of tryptophan and other neutral amino acids. Indole derivatives of unabsorbed tryptophan formed by intestinal bacteria are excreted. The defect limits tryptophan availability for niacin biosynthesis and accounts for the pellagra-like signs and symptoms.

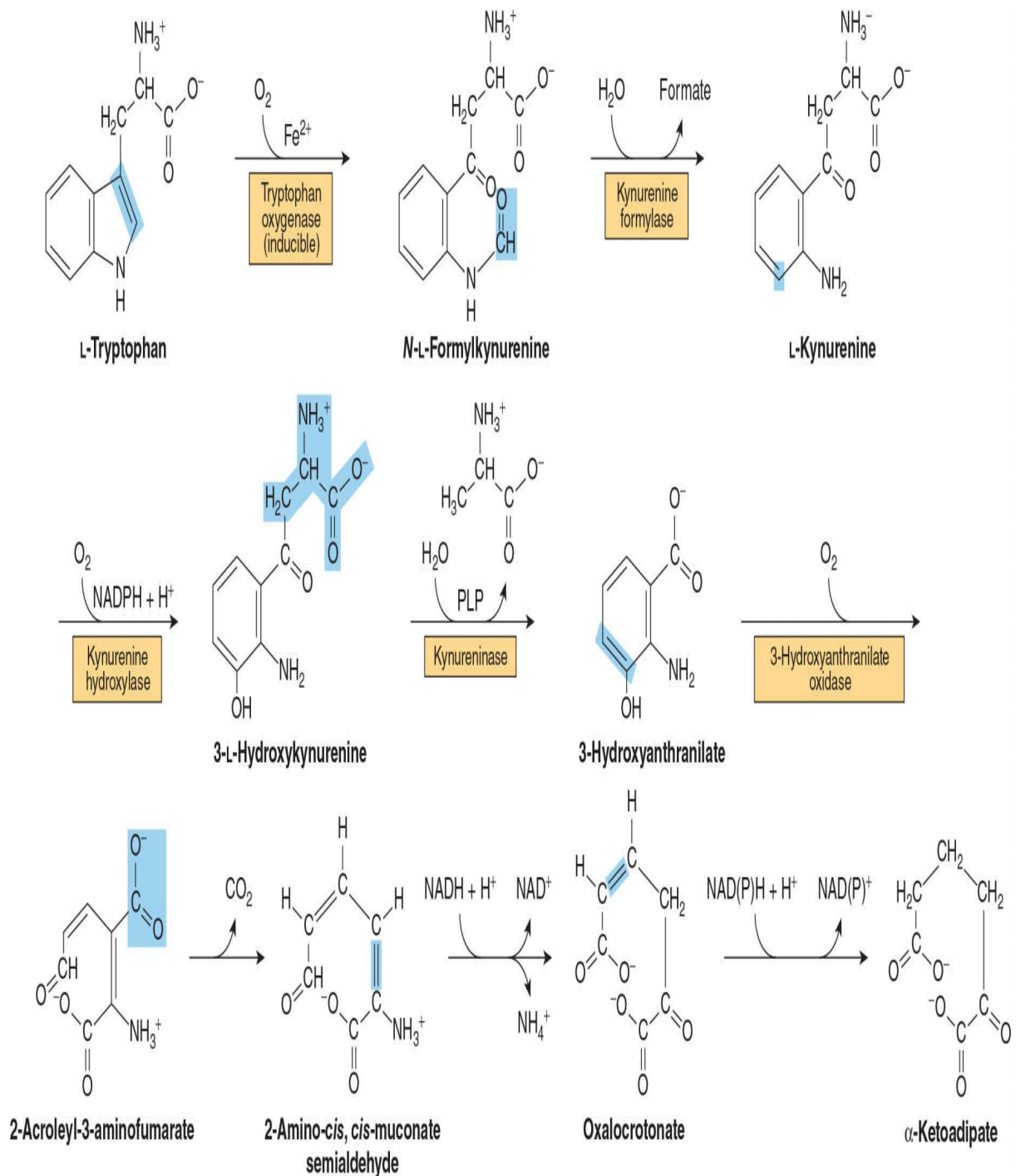

FIGURE 29–15 Reactions and intermediates in the catabolism of tryptophan. (PLP, pyridoxal phosphate.)

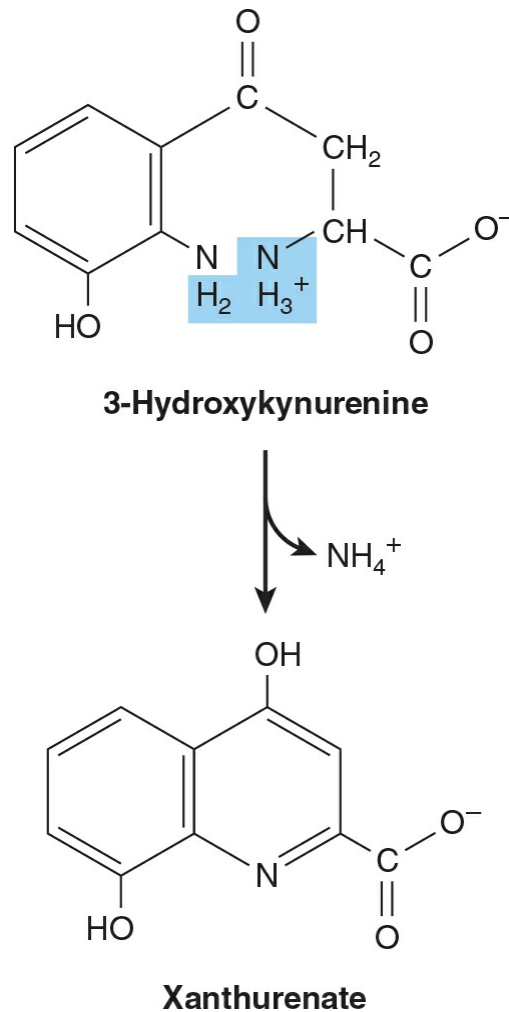

FIGURE 29–16 Formation of xanthurenate in vitamin B₆ deficiency.

Conversion of the tryptophan metabolite 3-hydroxykynurenine to 3-hydroxyanthranilate is impaired (see [Figure 29–15](#)). A large portion is therefore converted to xanthurenate.

Methionine

Methionine reacts with ATP forming S-adenosylmethionine, “active methionine” ([Figure 29–17](#)). Subsequent reactions form propionyl-CoA ([Figure 29–18](#)), whose conversion to succinyl-CoA occurs via reactions 2, 3 & 4 of [Figure 19-2](#).

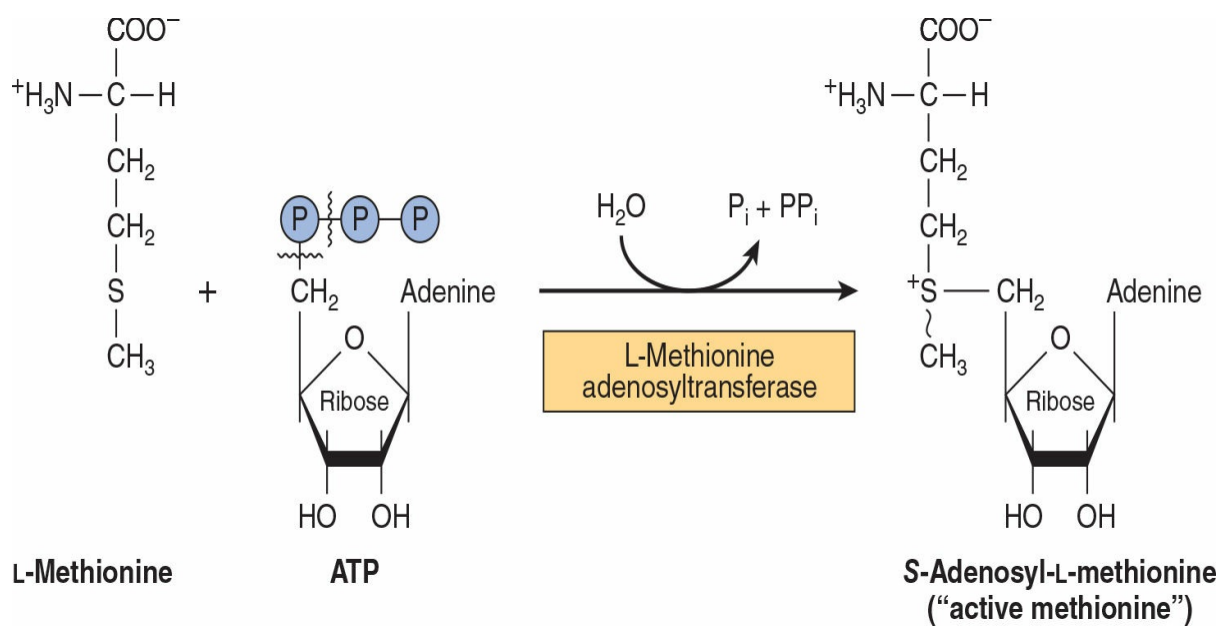

FIGURE 29–17 Formation of S-adenosylmethionine. ~ CH_3 represents the high group transfer potential of “active methionine.”

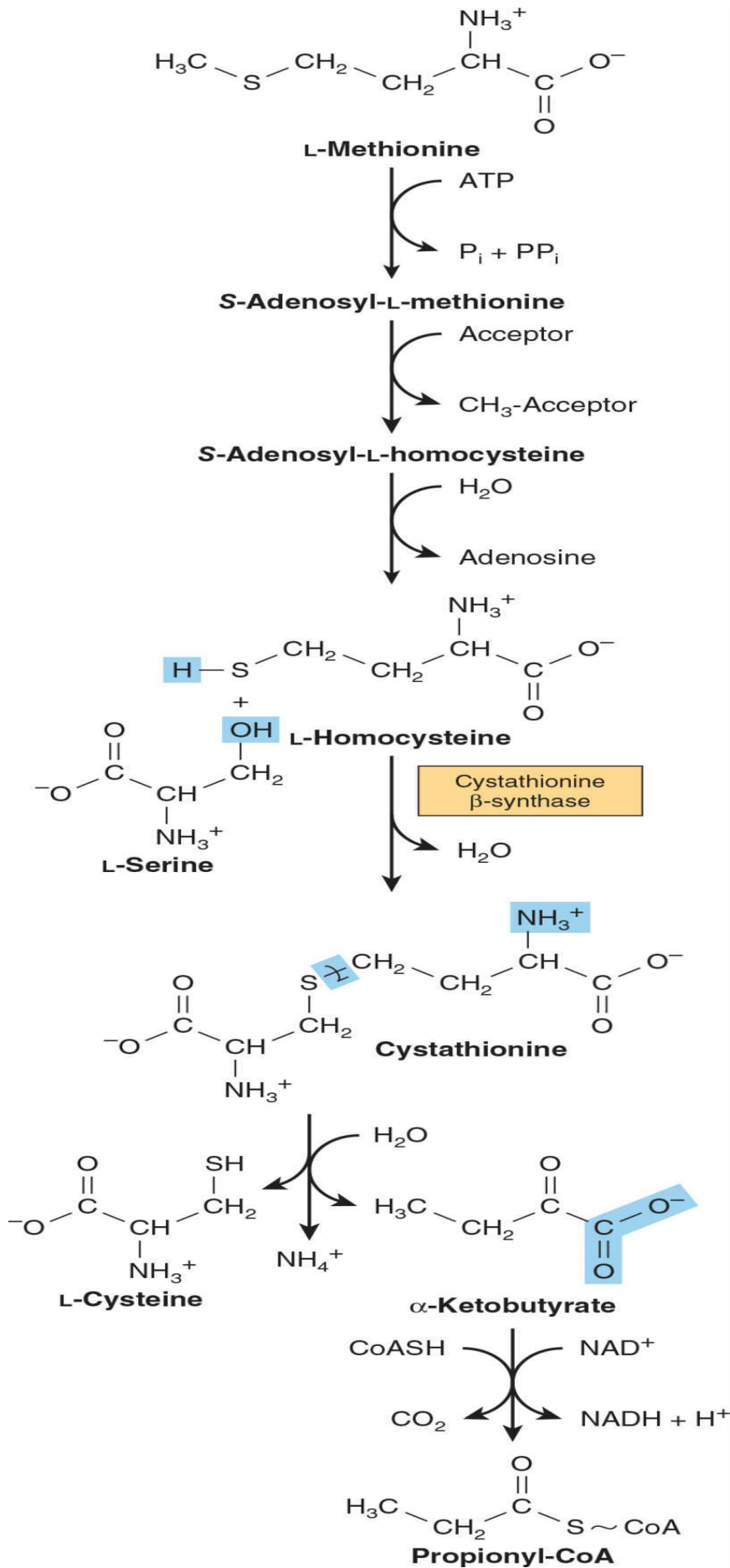

FIGURE 29–18 Conversion of methionine to propionyl-CoA.

THE INITIAL REACTIONS ARE COMMON TO ALL THREE BRANCHED-CHAIN AMINO ACIDS

The first three reactions of the catabolism of isoleucine, leucine, and valine (**Figure 29–19**) are analogous to reactions of fatty acid catabolism (see **Figure 22–3**). Following transamination (**Figure 29–19**, reaction 1), the carbon skeletons of the resulting α -keto acids undergo oxidative decarboxylation and conversion to coenzyme A thioesters. This multistep process is catalyzed by the **mitochondrial branched-chain α -ketoacid dehydrogenase complex**, whose components are functionally identical to those of the pyruvate dehydrogenase complex (PDH) (see **Figure 18–5**). Like PDH, the branched-chain α -ketoacid dehydrogenase complex consists of five components.

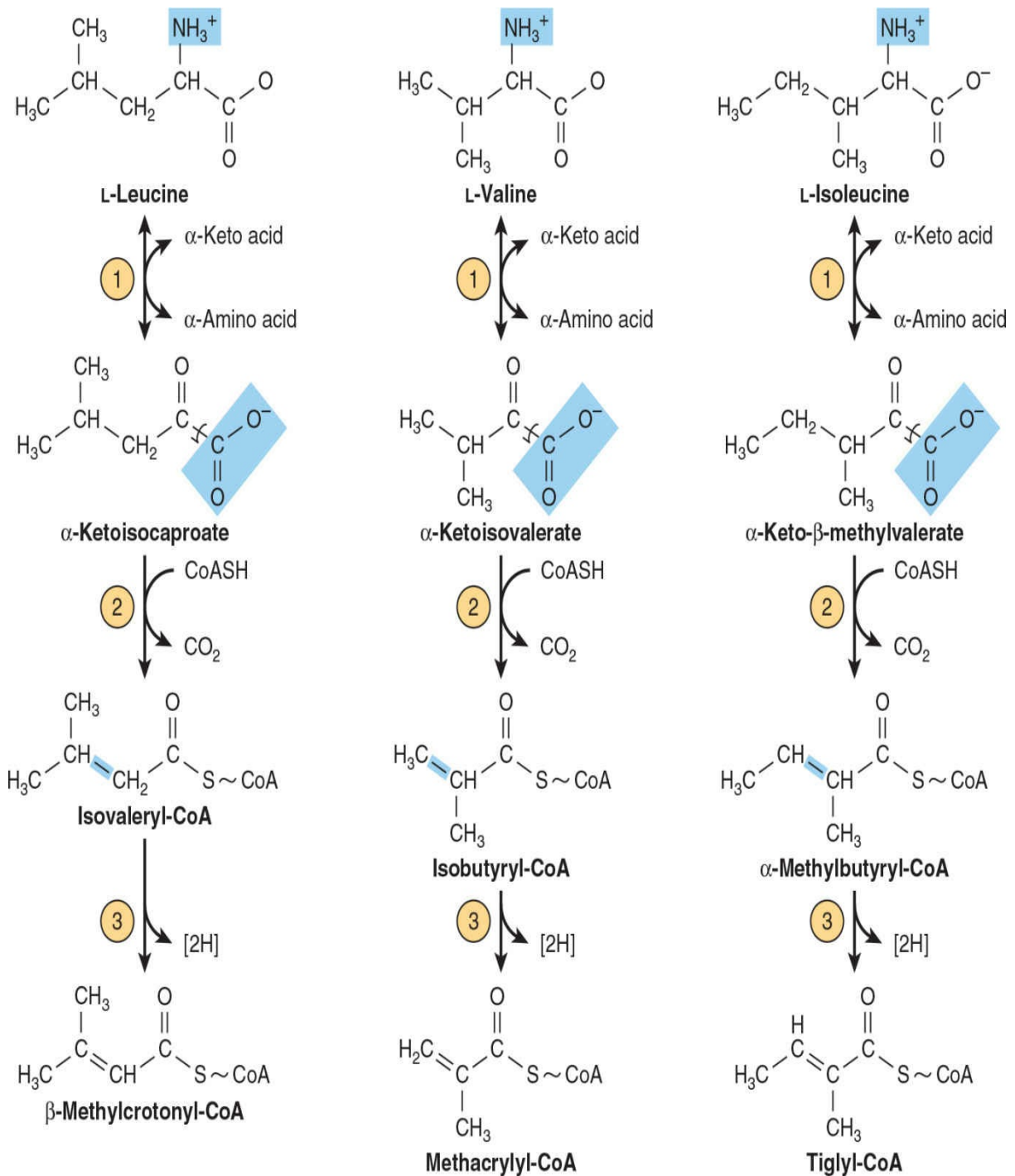

FIGURE 29–19 The first three reactions in the catabolism of leucine, valine, and isoleucine. Note the analogy of reactions 2 and 3 to reactions of the catabolism of fatty acids (see Figure 22–3). The analogy to fatty acid catabolism continues, as shown in subsequent figures.

E1: thiamin pyrophosphate (TPP)-dependent branched-chain α -ketoacid decarboxylase

E2: dihydrolipoyl transacylase (contains lipoamide)

E3: dihydrolipoamide dehydrogenase (contains FAD)

Protein kinase

Protein phosphatase

As for pyruvate dehydrogenase, the protein kinase and protein phosphatase regulate activity of the branched-chain α -ketoacid dehydrogenase complex via phosphorylation (inactivation) and dephosphorylation (activation).

Dehydrogenation of the resulting coenzyme A thioesters (reaction 3, [Figure 29–19](#)) proceeds like the dehydrogenation of lipid-derived fatty acyl-CoA thioesters (see [Chapter 22](#)). Subsequent reactions that are unique for each amino acid skeleton are given in [Figures 29–20](#), [29–21](#), and [29–22](#).

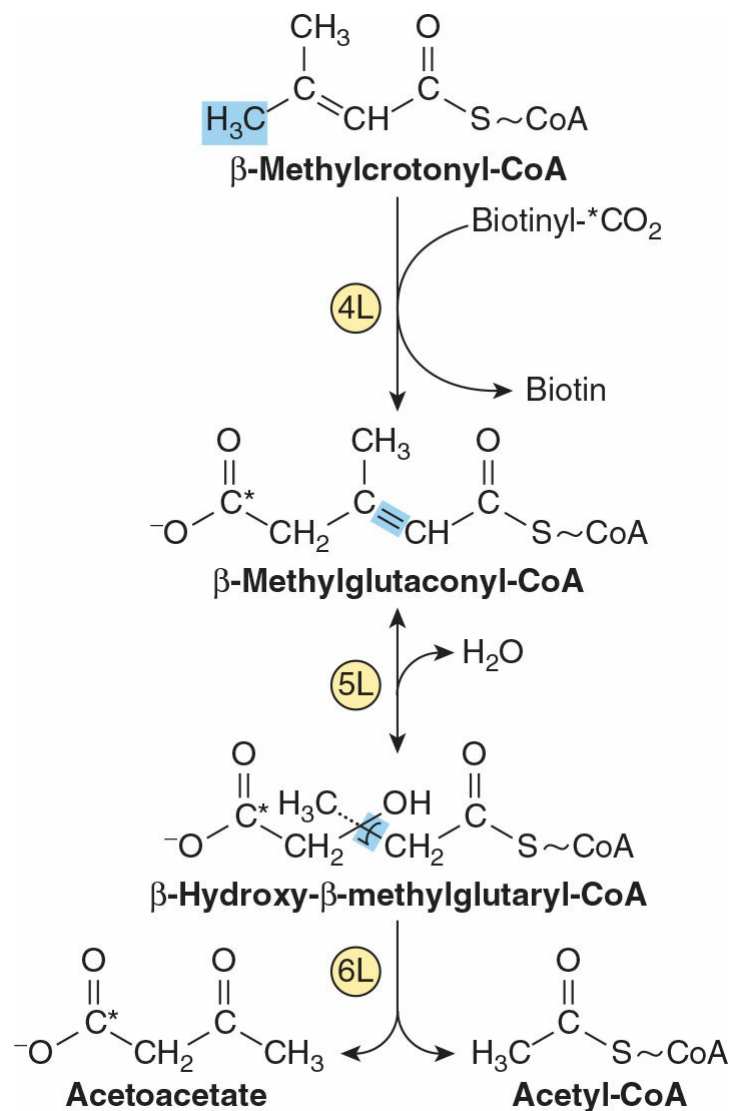

FIGURE 29–20 Catabolism of the β -methylcrotonyl-CoA formed

from L-leucine. Asterisks indicate carbon atoms derived from CO₂.

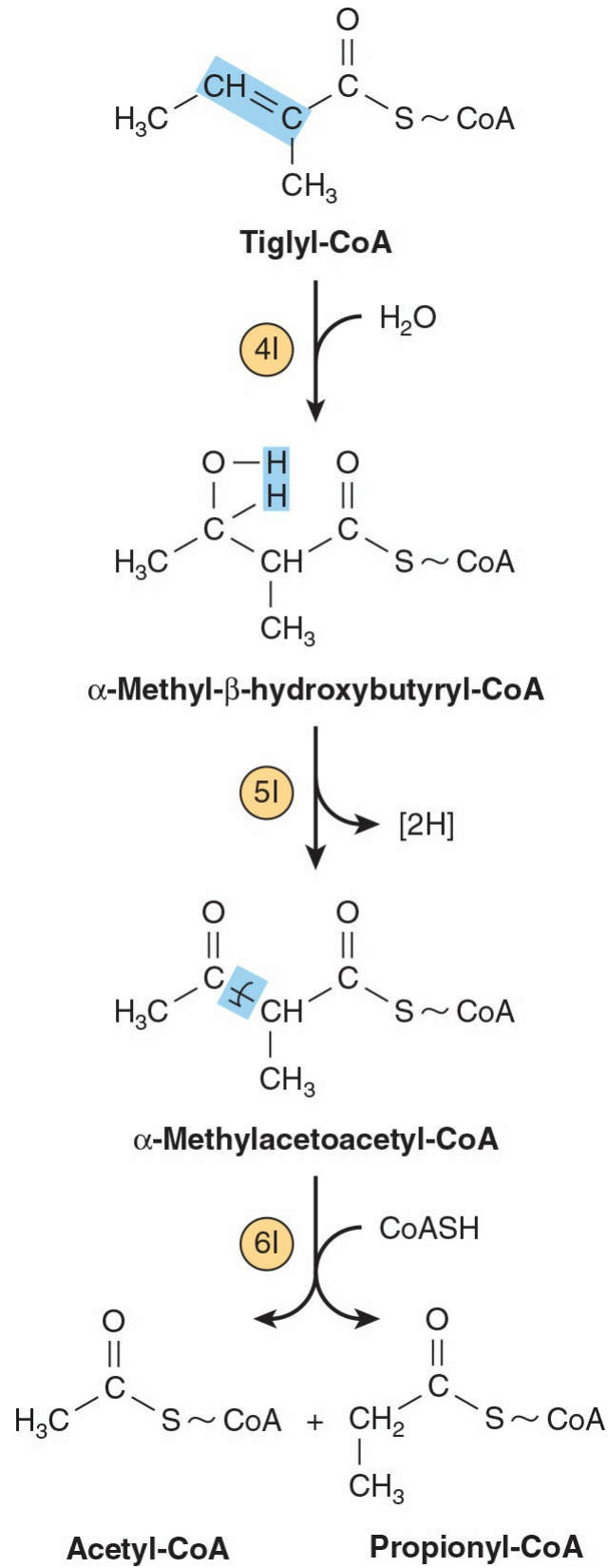

FIGURE 29–21 Subsequent catabolism of the tiglyl-CoA formed from

L-isoleucine.

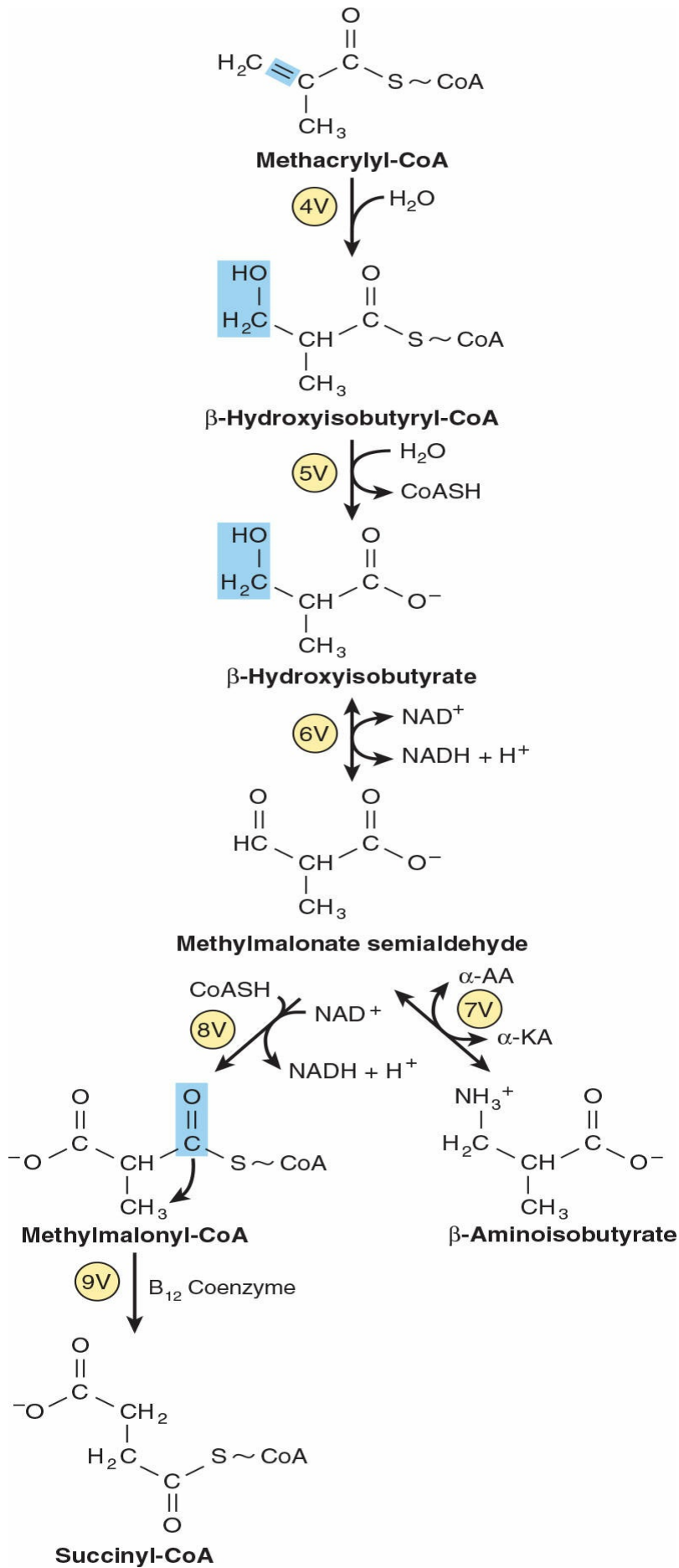

FIGURE 29–22 Subsequent catabolism of the methacrylyl-CoA formed from L-valine (see [Figure 29–19](#)). (α -AA, α -amino acid; α -KA, α -keto acid.)

METABOLIC DISORDERS OF BRANCHED-CHAIN AMINO ACID CATABOLISM

As the name implies, the odor of urine in **maple syrup urine disease (branched-chain ketonuria, or MSUD)** suggests maple syrup, or burnt sugar. The biochemical defect in MSUD involves the **α -ketoacid decarboxylase complex** (reaction 2, [Figure 29–19](#)). Plasma and urinary levels of leucine, isoleucine, valine, and their α -keto acids and α -hydroxy acids (reduced α -keto acids) are elevated, but the urinary keto acids derive principally from leucine. Signs and symptoms of MSUD often include fatal ketoacidosis, neurological derangements, mental retardation, and a maple syrup odor of urine. The mechanism of toxicity is unknown. Early diagnosis by enzymatic analysis is essential to avoid brain damage and early mortality by replacing dietary protein by an amino acid mixture that lacks leucine, isoleucine, and valine.

The molecular genetics of MSUD are heterogeneous. MSUD can result from mutations in the genes that encode E1 α , E1 β , E2, and E3. Based on the locus affected, genetic subtypes of MSUD are recognized. Type IA MSUD arises from mutations in the *E1 α* gene, type IB in the *E1 β* gene, type II in the *E2* gene, and type III in the *E3* gene ([Table 29–2](#)). In **intermittent branched-chain ketonuria**, the α -ketoacid decarboxylase retains some activity, and symptoms occur later in life. In **isovaleric acidemia**, ingestion of protein-rich foods elevates isovalerate, the deacylation product of isovaleryl-CoA. The impaired enzyme in **isovaleric acidemia** is **isovaleryl-CoA dehydrogenase**, EC 1.3.8.4 (reaction 3, [Figure 29–19](#)). Vomiting, acidosis, and coma follow ingestion of excess protein. Accumulated isovaleryl-CoA is hydrolyzed to isovalerate and excreted.

TABLE 29–2 Maple Syrup Urine Disease Can Reflect Impaired Function of Various Components of the α -Ketoacid Decarboxylase Complex

Branched-Chain α -Ketoacid Decarboxylase Component		OMIM ^a Reference	Maple Syrup Urine Disease
E1 α	α -Ketoacid decarboxylase	608348	Type 1A
E1 β	α -Ketoacid decarboxylase	248611	Type 1B
E2	Dihydrolipoyl transacylase	608770	Type II
E3	Dihydrolipoamide dehydrogenase	238331	Type III

^aOnline Mendelian Inheritance in Man database: ncbi.nlm.nih.gov/omim/.

Table 29–3 summarizes the metabolic disorders associated with the catabolism of amino acids, and lists the impaired enzyme, its IUB enzyme catalog (EC) number, a cross-reference to a specific figure, and numbered reaction in this text, and a numerical link to the Online Mendelian Inheritance in Man database (**OMIM**).

TABLE 29–3 Metabolic Diseases of Amino Acid Metabolism

Defective Enzyme	Enzyme Catalog Number	OMIM ^a Reference	Major Signs and Symptoms	Figure and Reaction
S-Adenosylhomocysteine hydrolase	3.3.1.1	180960	Hypermethioninemia	29-18 ③
Arginase	3.5.3.1	207800	Argininemia	29-3 ①
Cystathionine-β-synthase	4.2.1.22	236200	Homocystinuria	29-18 ④
Fumarylacetoacetate hydrolase	3.7.1.12	276700	Type I tyrosinemia (tyrosinosis)	29-12 ④
Histidine ammonia lyase (histidase)	4.3.1.3	609457	Histidinemia & urocanic acidemia	29-4 ①
Homogentisate oxidase	1.13.11.5	607474	Alkaptonuria. Homogentisate excreted	29-12 ③
p-Hydroxyphenylpyruvate hydroxylase	1.13.11.27	276710	Neonatal tyrosinemia	29-12 ③
Isovaleryl-CoA dehydrogenase	1.3.8.4	607036	Isovaleric acidemia	29-19 ③
Branched chain α-ketoacid decarboxylase complex		248600	Branched-chain ketonuria (MSUD)	29-19 ①
Methionine adenosyltransferase	2.5.1.6	250850	Hypermethioninemia	29-17 ①
Ornithine-δ-aminotransferase	2.6.1.13	258870	Ornithemia, gyrate atrophy	29-3 ②
Phenylalanine hydroxylase	1.14.16.1	261600	Type I (classic) phenylketonuria	27-9 ①
Proline dehydrogenase	1.5.5.2	606810	Type I hyperprolinemia	29-2 ①
Δ ¹ -Pyrroline-5-carboxylate dehydrogenase	1.2.1.88	606811	Type II hyperprolinemia & hyper 4-hydroxyprolinemia	29-2 ②
Saccharopine dehydrogenase	1.5.1.7	268700	Saccharopinuria	29-14 ②
Tyrosine aminotransferase	2.6.1.5	613018	Type II tyrosinemia	29-12 ①

^aOnline Mendelian Inheritance in Man database: ncbi.nlm.nih.gov/omim/.

SUMMARY

- Excess amino acids are catabolized to amphibolic intermediates that serve as sources of energy or for the biosynthesis of carbohydrates and lipids.
- Transamination is the most common initial reaction of amino acid catabolism. Subsequent reactions remove any additional nitrogen and restructure hydrocarbon skeletons for conversion to oxaloacetate, α-ketoglutarate, pyruvate, and acetyl-CoA.
- Metabolic diseases associated with glycine catabolism include

glycinuria and primary hyperoxaluria.

- Two distinct pathways convert cysteine to pyruvate. Metabolic disorders of cysteine catabolism include cystine-lysinuria, cystine storage disease, and the homocystinurias.
- Threonine catabolism merges with that of glycine after threonine aldolase cleaves threonine to glycine and acetaldehyde.
- Following transamination, the carbon skeleton of tyrosine is degraded to fumarate and acetoacetate. Metabolic diseases of tyrosine catabolism include tyrosinosis, Richner-Hanhart syndrome, neonatal tyrosinemia, and alkaptonuria.
- Metabolic disorders of phenylalanine catabolism include PKU and several hyperphenylalaninemias.
- Neither nitrogen of lysine participates in transamination. The same net effect is, however, achieved by the intermediate formation of saccharopine. Metabolic diseases of lysine catabolism include periodic and persistent forms of hyperlysinemia-ammonemia.
- The catabolism of leucine, valine, and isoleucine presents many analogies to fatty acid catabolism. Metabolic disorders of branched-chain amino acid catabolism include hypervalinemia, maple syrup urine disease, intermittent branched-chain ketonuria, isovaleric acidemia, and methylmalonic aciduria.

REFERENCES

- Blikrud YT, Brodtkorb E, Andresen PA, et al: Tyrosinemia type I, de novo mutation in liver tissue suppressing an inborn splicing defect. *J Mol Med* 2005;83:406.
- Dobrowolski SF, Pey AL, Koch R, et al: Biochemical characterization of mutant phenylalanine hydroxylase enzymes and correlation with clinical presentation in hyperphenylalaninaemic patients. *J Inher Metab Dis* 2009;32:10.
- Garg U, Dasouki M: Expanded newborn screening of inherited metabolic disorders by tandem mass spectrometry. Clinical and laboratory aspects. *Clin Biochem* 2006;39:315.
- Geng J, Liu A: Heme-dependent dioxygenases in tryptophan oxidation. *Arch Biochem Biophys* 2014;44:18.
- Heldt K, Schwahn B, Marquardt I, et al: Diagnosis of maple syrup urine disease by newborn screening allows early intervention without extraneous detoxification. *Mol Genet Metab* 2005;84:313.

- Houten SM, Te Brinke H, Denis S, et al: Genetic basis of hyperlysinemia. *Orphanet J Rare Dis* 2013;8:57.
- Lamp J, Keyser B, Koeller DM, et al: Glutaric aciduria type 1 metabolites impair the succinate transport from astrocytic to neuronal cells. *J Biol Chem* 2011;286:17-777.
- Mayr JA, Feichtinger RG, Tort F, et al: Lipoic acid biosynthesis defects. *J Inherit Metab Dis* 2014;37:553.
- Nagao M, Tanaka T, Furujo M: Spectrum of mutations associated with methionine adenosyltransferase I/III deficiency among individuals identified during newborn screening in Japan. *Mol Genet Metab* 2013;110:460.
- Stenn FF, Milgram JW, Lee SL, et al: Biochemical identification of homogentisic acid pigment in an ochronotic Egyptian mummy. *Science* 1977;197:566.
- Tondo M, Calpena E, Arriola G, et al: Clinical, biochemical, molecular and therapeutic aspects of 2 new cases of 2-amino adipic semialdehyde synthase deficiency. *Mol Genet Metab* 2013;110:231.

Conversion of Amino Acids to Specialized Products

Victor W. Rodwell, PhD

OBJECTIVES

After studying this chapter, you should be able to:

- Cite examples of how amino acids participate in a variety of biosynthetic processes other than protein synthesis.
- Outline how arginine participates in the biosynthesis of creatine, nitric oxide (NO), putrescine, spermine, and spermidine.
- Indicate the contribution of cysteine and of β -alanine to the structure of coenzyme A.
- Discuss the role played by glycine in drug catabolism and excretion.
- Document the role of glycine in the biosynthesis of heme, purines, creatine, and sarcosine.
- Identify the reaction that converts an amino acid to the neurotransmitter histamine.
- Document the role of *S*-adenosylmethionine in metabolism.
- Recognize the structures of tryptophan metabolites serotonin, melatonin, tryptamine, and indole 3-acetate.

- Describe how tyrosine gives rise to norepinephrine and epinephrine.
- Illustrate the key roles of peptidyl serine, threonine, and tyrosine in metabolic regulation and signal transduction pathways.
- Diagram the roles of glycine, arginine, and S-adenosylmethionine in the biosynthesis of creatine.
- Explain the role of creatine phosphate in energy homeostasis.
- Illustrate the formation of γ -aminobutyrate (GABA) and the rare metabolic disorders associated with defects in GABA catabolism.

BIOMEDICAL IMPORTANCE

Certain proteins contain amino acids that have been posttranslationally modified to permit them to perform specific functions. Examples include the carboxylation of glutamate to form γ -carboxyglutamate, which functions in Ca^{2+} binding, the hydroxylation of proline for incorporation into the collagen triple helix, and the hydroxylation of lysine to 5-hydroxylysine, whose subsequent modification and cross-linking stabilize maturing collagen fibers. In addition to serving as the building blocks for protein synthesis, amino acids serve as precursors of biologic materials as diverse and important as heme, purines, pyrimidines, hormones, neurotransmitters, and biologically active peptides. Histamine plays a central role in many allergic reactions. Neurotransmitters derived from amino acids include γ -aminobutyrate (GABA), 5-hydroxytryptamine (serotonin), dopamine, norepinephrine, and epinephrine. Many drugs used to treat neurologic and psychiatric conditions act by altering the metabolism of these neurotransmitters. Discussed below are the metabolism and metabolic roles of selected α - and non- α -amino acids.

L- α -AMINO ACIDS

Alanine

Alanine serves as a carrier of ammonia and of the carbons of pyruvate from skeletal muscle to liver via the Cori cycle (see [Chapters 19 & 28](#)), and together with glycine constitutes a major fraction of the free amino acids in plasma.

Arginine

Figure 30–1 summarizes the metabolic fates of arginine. In addition to serving as a carrier of nitrogen atoms in urea biosynthesis (see [Figure 28–16](#)), the guanidino group of arginine is incorporated into creatine, and following conversion to ornithine, its carbon skeleton becomes that of the polyamines putrescine and spermine (see below).

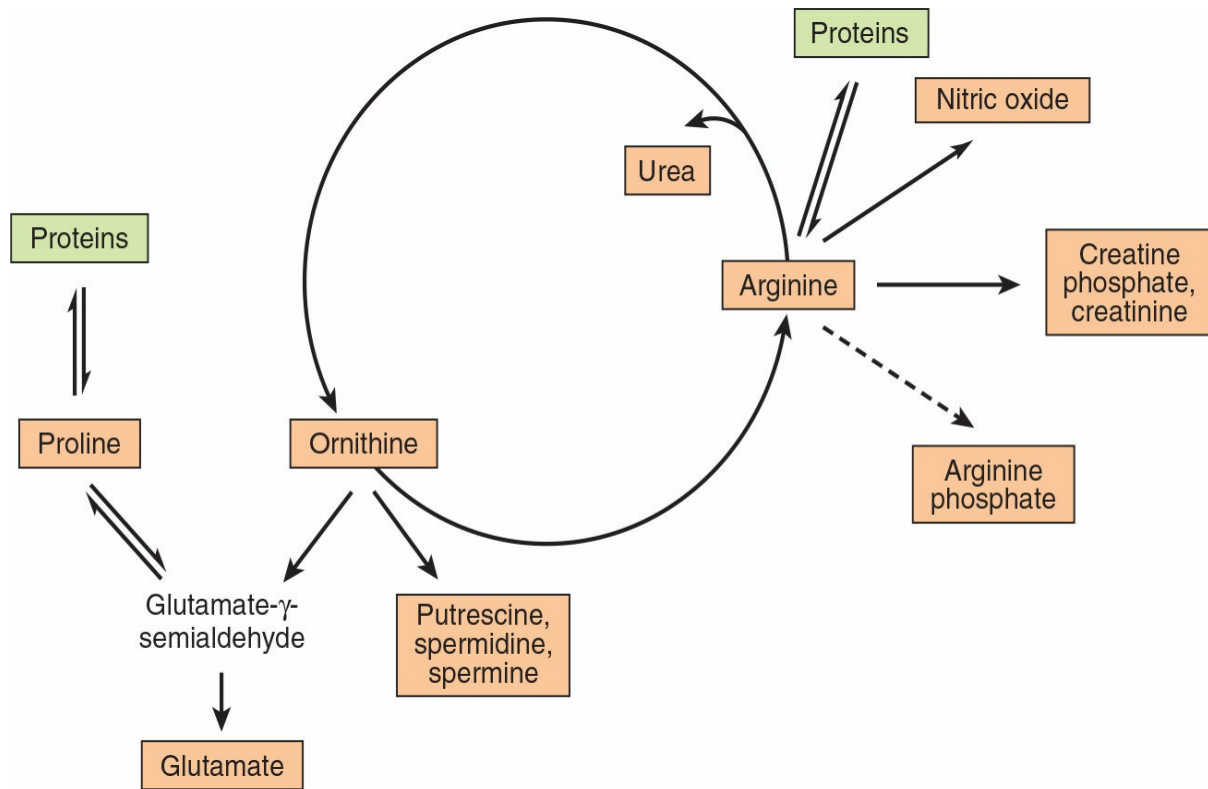

FIGURE 30–1 Arginine, ornithine, and proline metabolism. Reactions with solid arrows all occur in mammalian tissues. Putrescine and spermine synthesis occurs in both mammals and bacteria. Arginine phosphate of invertebrate muscle functions as a phosphagen analogous to creatine phosphate of mammalian muscle.

The reaction catalyzed by nitric oxide synthase, EC 1.14.13.39 ([Figure 30–2](#)), a five-electron oxidoreductase with multiple cofactors, converts one nitrogen of the guanidino group of arginine to L-ornithine and nitric oxide, an intercellular signaling molecule that serves as a neurotransmitter, smooth muscle relaxant, and vasodilator (see [Chapter 51](#)).

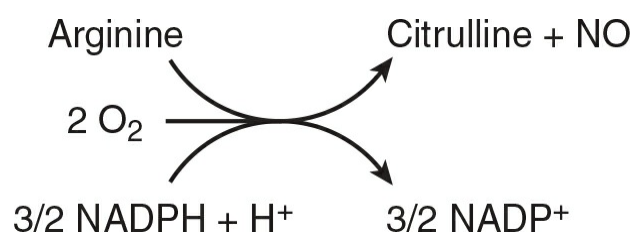

FIGURE 30–2 The reaction catalyzed by nitric oxide synthase.

Cysteine

Cysteine participates in the biosynthesis of coenzyme A (see [Chapter 44](#)) by reacting with pantothenate to form 4-phosphopantothencysteine. Taurine, formed from cysteine, can displace the coenzyme A moiety of cholel-CoA to form the bile acid taurocholic acid (see [Chapter 26](#)). The conversion of cysteine to taurine involves catalysis by the nonheme Fe²⁺ enzyme cysteine dioxygenase, (EC 1.13.11.20), sulfinoalanine decarboxylase (EC 4.1.1.29), and hypotaurine dehydrogenase (EC 1.8.1.3) ([Figure 30–3](#)).

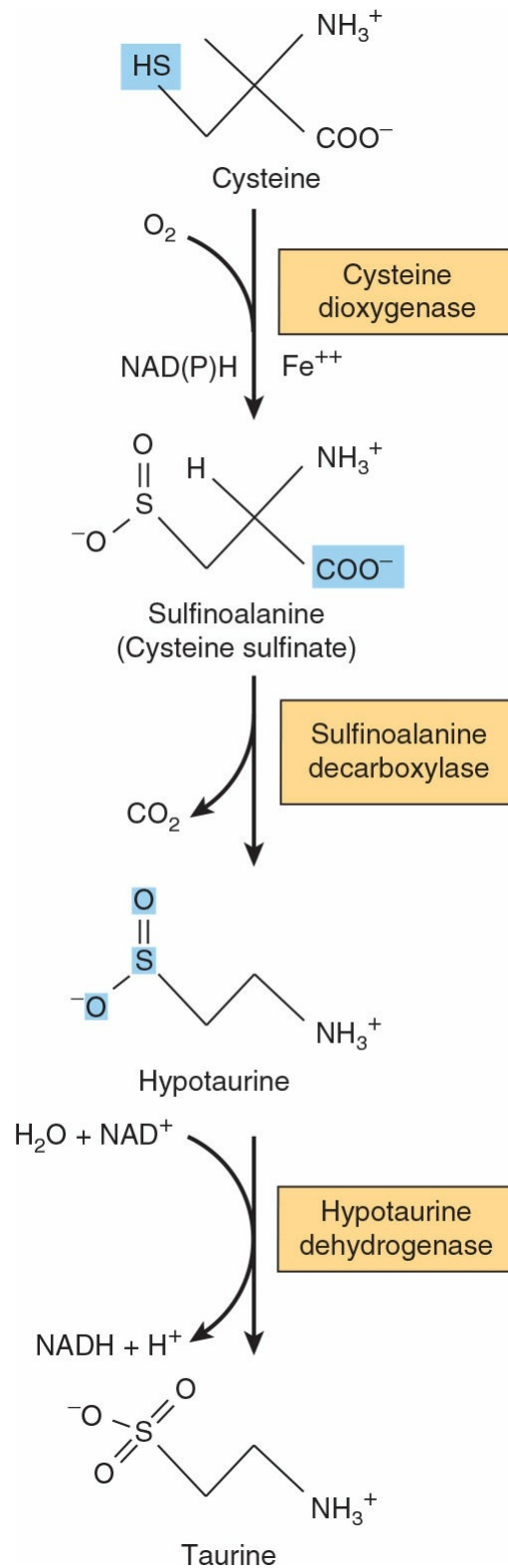

FIGURE 30–3 Conversion of cysteine to taurine. The reactions are catalyzed by cysteine dioxygenase, cysteine sulfinate decarboxylase, and hypotaurine dehydrogenase, respectively.

Glycine

Many relatively apolar metabolites are converted to water-soluble glycine conjugates. An example is the hippuric acid formed from the food additive benzoate (**Figure 30–4**). Many drugs, drug metabolites, and other compounds with carboxyl groups are conjugated with glycine. This makes them more water soluble and thereby facilitates their excretion in the urine.

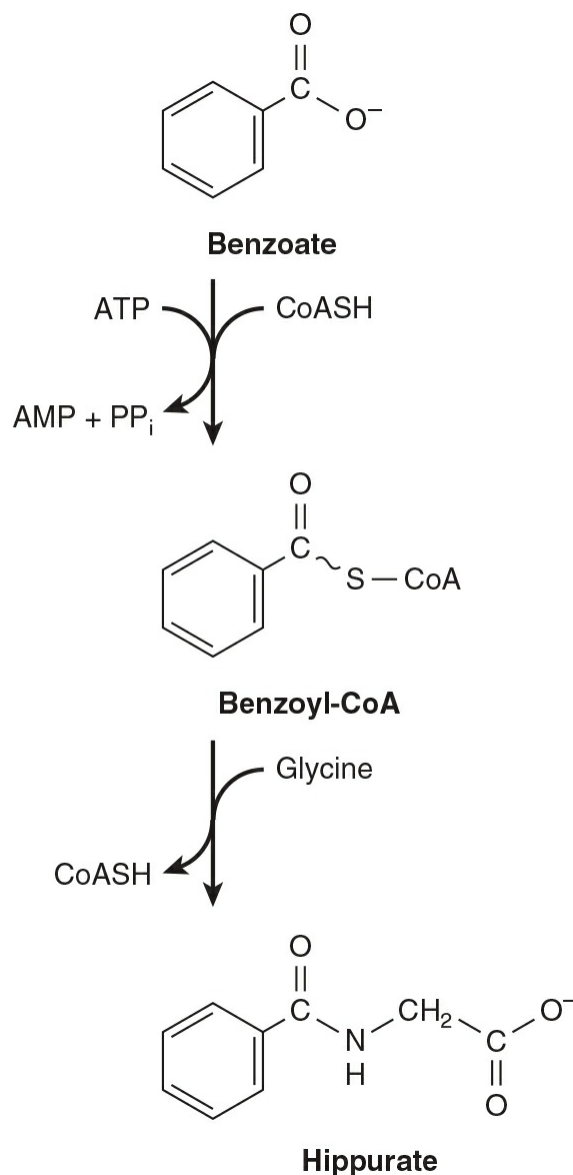

FIGURE 30–4 Biosynthesis of hippurate. Analogous reactions occur with many acidic drugs and catabolites.

Glycine is incorporated into creatine, and the nitrogen and α -carbon of glycine are incorporated into the pyrrole rings and the methylene bridge carbons of heme (see **Chapter 31**), and the entire glycine molecule becomes atoms 4, 5, and 7 of the purines (see **Figure 33–1**).

Histidine

Decarboxylation of histidine to histamine is catalyzed by the pyridoxal 5'-phosphate-dependent enzyme histidine decarboxylase, EC 4.1.1.22 (**Figure 30–5**). A biogenic amine that functions in allergic reactions and gastric secretion, histamine is present in all tissues. Its concentration in the brain hypothalamus varies in accordance with a circadian rhythm. Histidine compounds present in the human body include carnosine, and dietarily derived ergothioneine and anserine (**Figure 30–6**). Carnosine (β -alanyl-histidine) and homocarnosine (γ -aminobutyryl-histidine) are major constituents of excitable tissues, brain, and skeletal muscle. Urinary levels of 3-methylhistidine are unusually low in patients with **Wilson disease**.

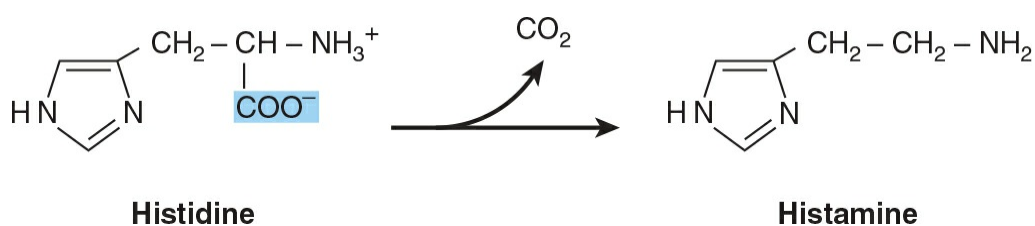
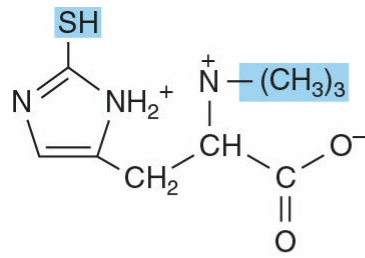
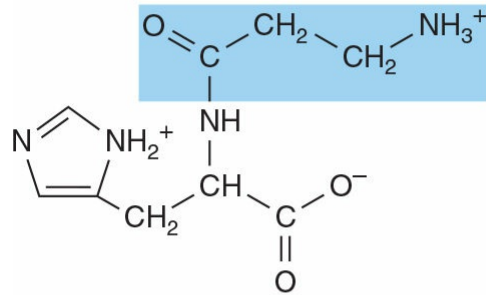

FIGURE 30–5 The reaction catalyzed by histidine decarboxylase.



Ergothioneine



Carnosine

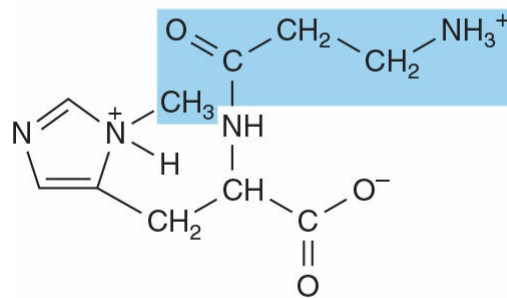

Anserine

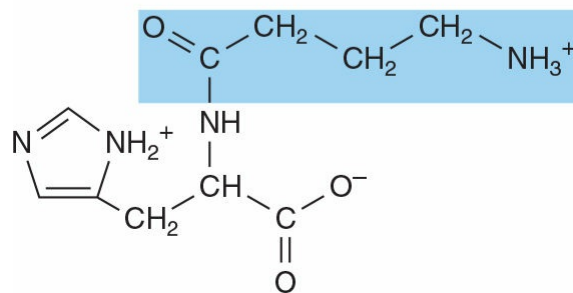

Homocarnosine

FIGURE 30–6 Derivatives of histidine. Colored boxes surround the components not derived from histidine. The SH group of ergothioneine derives from cysteine.

Methionine

The major nonprotein fate of methionine is conversion to *S*-adenosylmethionine, the principal source of methyl groups in the body. Biosynthesis of *S*-adenosylmethionine from methionine and ATP is catalyzed by methionine adenosyltransferase (MAT), EC 2.5.1.6 (**Figure 30–7**). Human tissues contain three MAT isozymes: MAT-1 and MAT-3 of liver and MAT-2 of nonhepatic tissues. Although **hypermethioninemia** can result from severely decreased hepatic MAT-1 and MAT-3 activity, if there is residual MAT-1 or MAT-3 activity and MAT-2 activity is normal, a high tissue concentration of methionine will ensure synthesis of adequate amounts of *S*-adenosylmethionine.

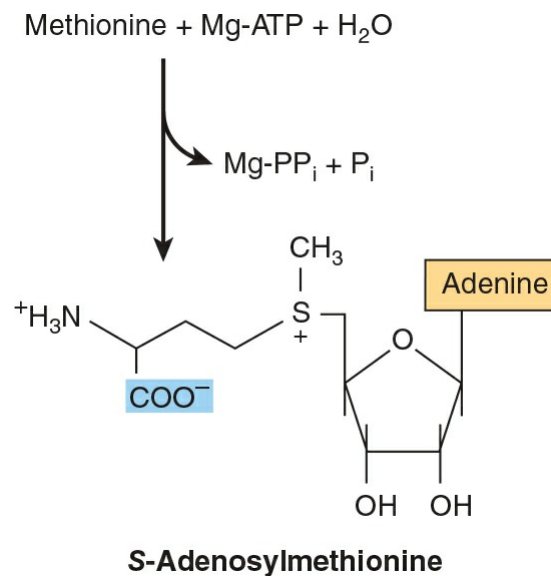

FIGURE 30–7 Biosynthesis of *S*-adenosylmethionine, catalyzed by methionine adenosyltransferase.

Following decarboxylation of *S*-adenosylmethionine by methionine decarboxylase (EC 4.1.1.57), three carbons and the α -amino group of methionine contribute to the biosynthesis of the polyamines **spermine** and **spermidine**. These polyamines function in cell proliferation and growth, are growth factors for cultured mammalian cells, and stabilize intact cells, subcellular organelles, and membranes. Pharmacologic doses of polyamines are hypothermic and hypotensive. Since they bear multiple positive charges, polyamines readily associate with DNA and RNA. **Figure 30–8** summarizes the biosynthesis of polyamines from methionine and ornithine, and **Figure 30–9** the catabolism of polyamines.

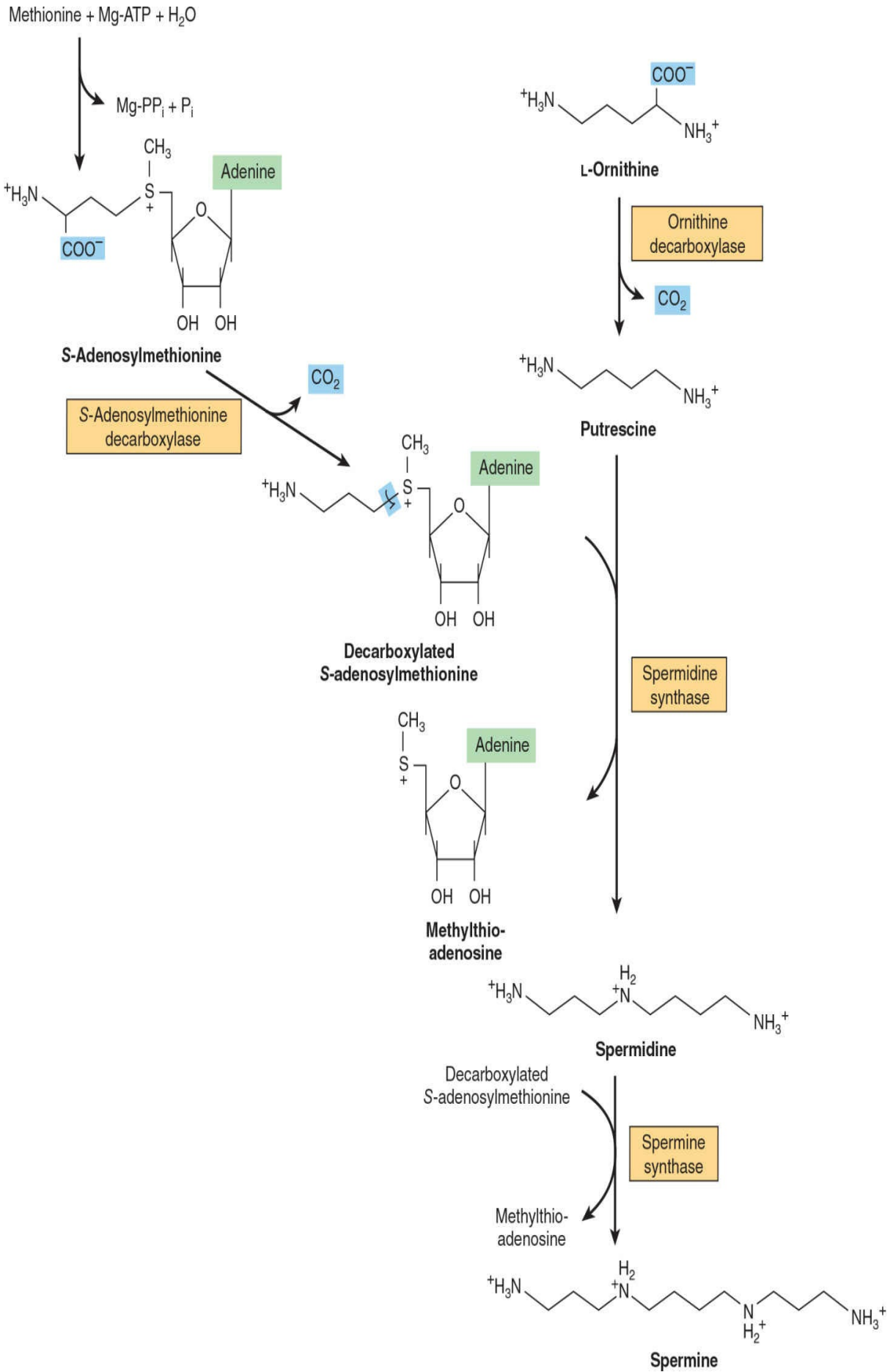

FIGURE 30–8 Intermediates and enzymes that participate in the biosynthesis of spermidine and spermine.

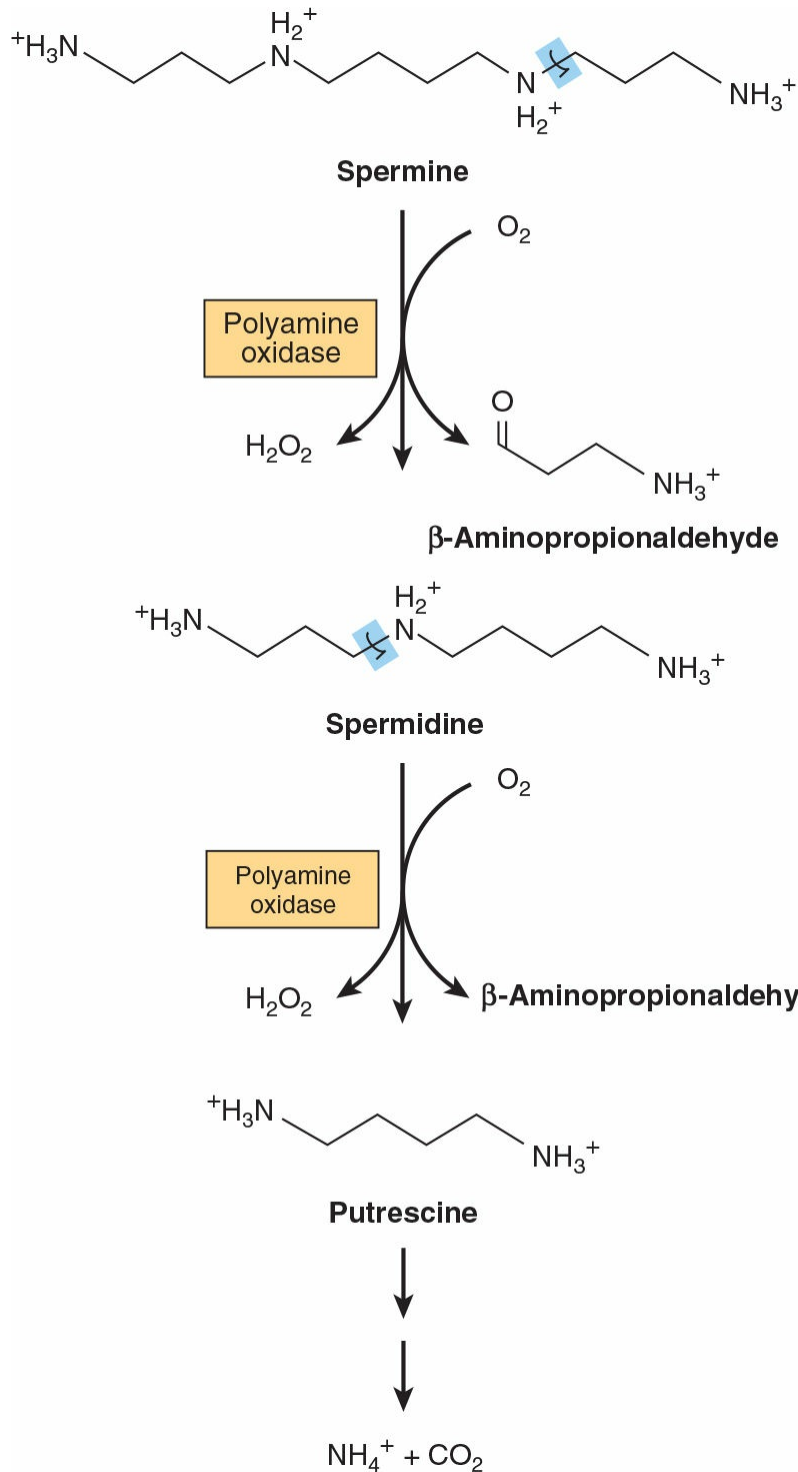
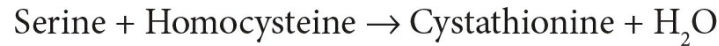

FIGURE 30–9 Catabolism of polyamines.

Serine

Serine participates in the biosynthesis of sphingosine (see [Chapter 24](#)), and of purines and pyrimidines, where it provides carbons 2 and 8 of purines and the methyl group of thymine (see [Chapter 33](#)). Genetic defects in cystathionine β -synthase (EC 4.2.1.22)



a heme protein that catalyzes the pyridoxal 5'-phosphate-dependent condensation of serine with homocysteine to form cystathionine, result in **homocystinuria**. Finally, serine (not cysteine) serves as the precursor of peptidyl selenocysteine (see [Chapter 27](#)).

Tryptophan

Following hydroxylation of tryptophan to 5-hydroxytryptophan by liver tryptophan hydroxylase (EC 1.14.16.4), subsequent decarboxylation forms serotonin (5-hydroxytryptamine), a potent vasoconstrictor and stimulator of smooth muscle contraction. Catabolism of serotonin is initiated by deamination to 5-hydroxyindole-3-acetate, a reaction catalyzed by monoamine oxidase, EC 1.4.3.4 ([Figure 30–10](#)). The psychic stimulation that follows administration of iproniazid results from its ability to prolong the action of serotonin by inhibiting monoamine oxidase. In carcinoid (argentaffinoma), tumor cells overproduce serotonin. Urinary metabolites of serotonin in patients with carcinoid include *N*-acetylserotonin glucuronide and the glycine conjugate of 5-hydroxyindoleacetate. Serotonin and 5-methoxytryptamine are metabolized to the corresponding acids by monoamine oxidase. *N*-Acetylation of serotonin, followed by its *O*-methylation in the pineal body, forms melatonin. Circulating melatonin is taken up by all tissues, including brain, but is rapidly metabolized by hydroxylation followed by conjugation with sulfate or with glucuronic acid. Kidney tissue, liver tissue, and fecal bacteria all convert tryptophan to tryptamine, then to indole 3-acetate. The principal normal urinary catabolites of tryptophan are 5-hydroxyindoleacetate and indole 3-acetate ([Figure 30–10](#)).

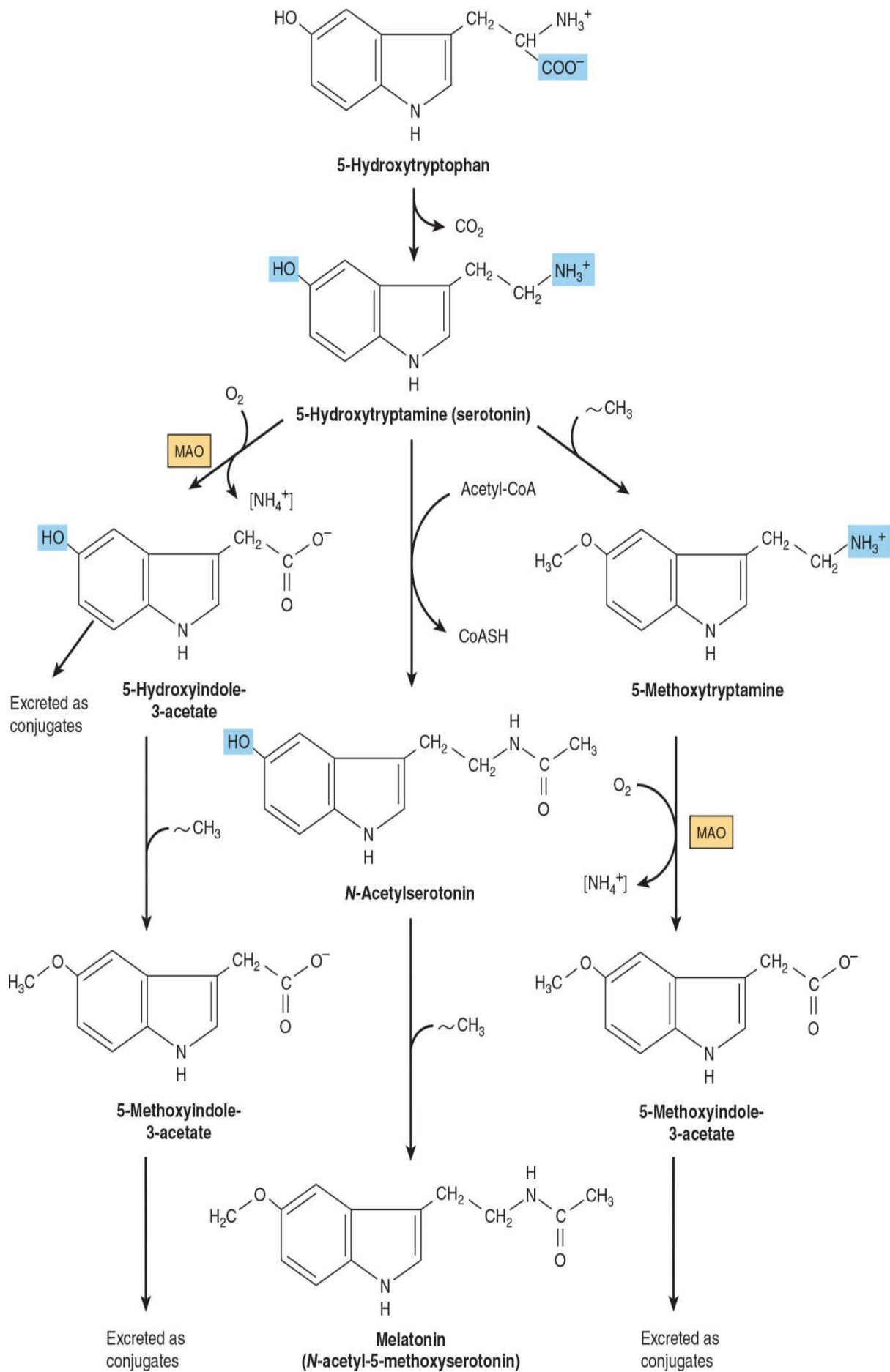

FIGURE 30–10 Biosynthesis and metabolism of serotonin and melatonin. ($[\text{NH}_4^+]$, by transamination; MAO, monoamine oxidase; $\sim\text{CH}_3$, from S-adenosylmethionine.)

Tyrosine

Neural cells convert tyrosine to epinephrine and norepinephrine (**Figure 30–11**). While dopa is also an intermediate in the formation of melanin, different enzymes hydroxylate tyrosine in melanocytes. DOPA decarboxylase (EC 4.1.1.28), a pyridoxal phosphate-dependent enzyme, forms dopamine. Subsequent hydroxylation, catalyzed by dopamine β -oxidase (EC 1.14.17.1), then forms norepinephrine. In the adrenal medulla, phenylethanolamine *N*-methyltransferase (EC 2.1.1.28) utilizes S-adenosylmethionine to methylate the primary amine of norepinephrine, forming epinephrine (**Figure 30–11**). Tyrosine is also a precursor of triiodothyronine and thyroxine (see **Chapter 41**).

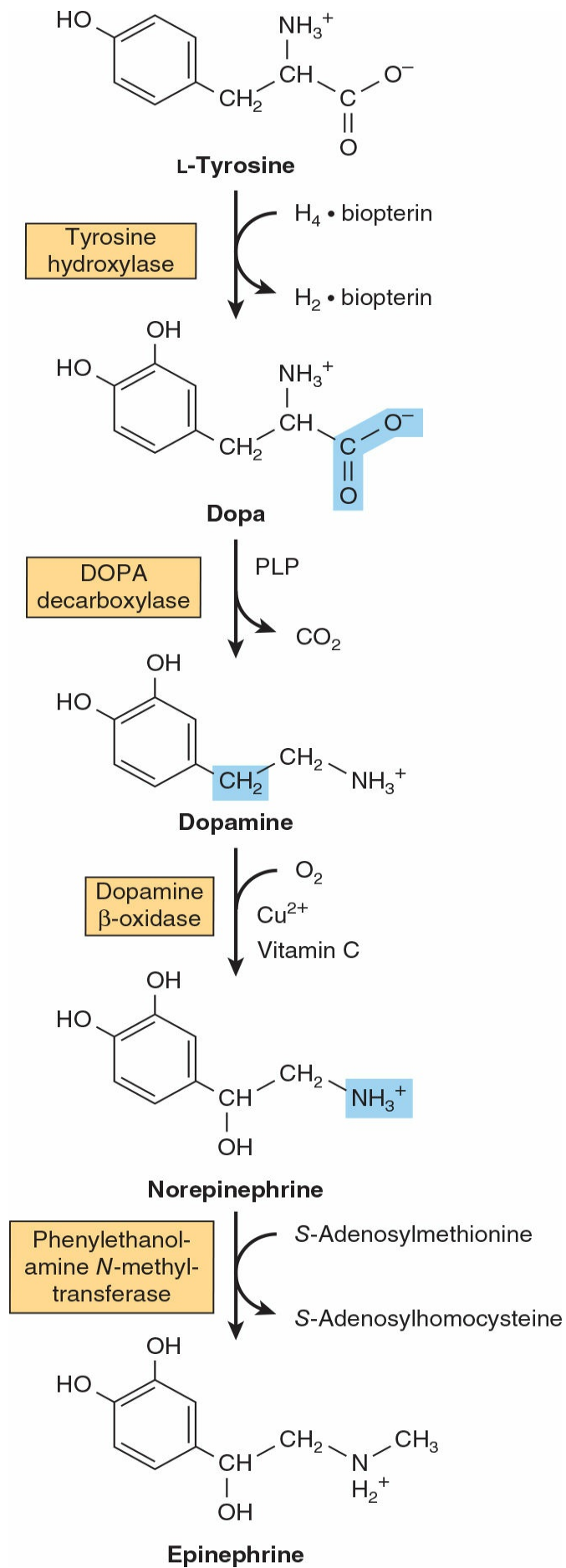

FIGURE 30–11 Conversion of tyrosine to epinephrine and norepinephrine in neuronal and adrenal cells. (PLP, pyridoxal phosphate.)

Phosphoserine, Phosphothreonine, & Phosphotyrosine

The phosphorylation and dephosphorylation of specific seryl, threonyl, or tyrosyl residues of proteins regulate the activity of certain enzymes of lipid and carbohydrate metabolism and of proteins that participate in signal transduction cascades (see [Chapter 42](#)).

Sarcosine (*N*-Methylglycine)

The biosynthesis and catabolism of sarcosine (*N*-methylglycine) occur in mitochondria. Formation of sarcosine from dimethyl glycine is catalyzed by the flavoprotein dimethyl glycine dehydrogenase EC 1.5.8.4, which requires reduced pteroylpentaglutamate (TPG).

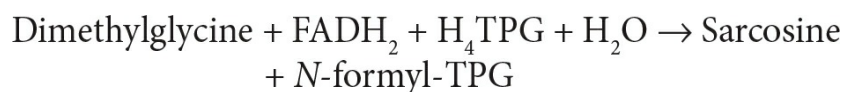

Traces of sarcosine can also arise by methylation of glycine, a reaction catalyzed by glycine *N*-methyltransferase, EC 2.1.1.20.

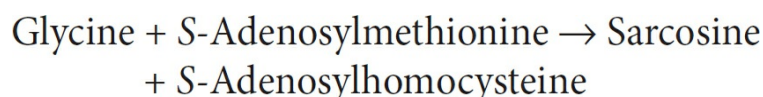

Catabolism of sarcosine to glycine, catalyzed by the flavoprotein sarcosine dehydrogenase EC 1.5.8.3, also requires reduced pteroylpentaglutamate.

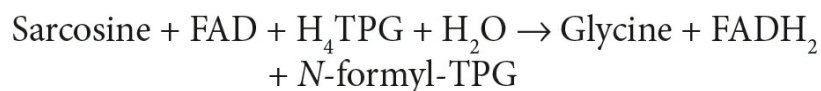

The demethylation reactions that form and degrade sarcosine represent important sources of one-carbon units. FADH₂ is reoxidized via the electron transport chain (see [Chapter 13](#)).

Creatine & Creatinine

Creatinine is formed in muscle from creatine phosphate by irreversible,

nonenzymatic dehydration, and loss of phosphate (**Figure 30–12**). Since the 24-hour urinary excretion of creatinine is proportionate to muscle mass, it provides a measure of whether a complete 24-hour urine specimen has been collected. Glycine, arginine, and methionine all participate in creatine biosynthesis. Synthesis of creatine is completed by methylation of guanidoacetate by *S*-adenosylmethionine (**Figure 30–12**).

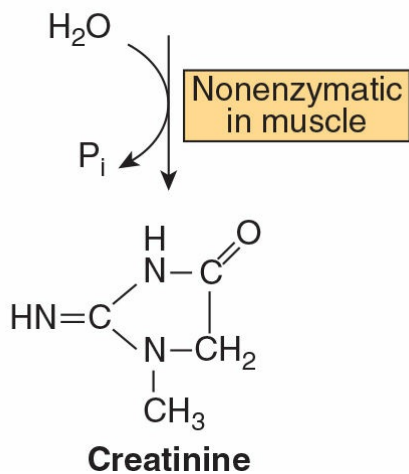
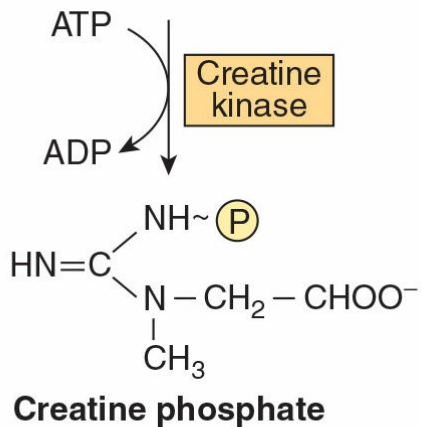
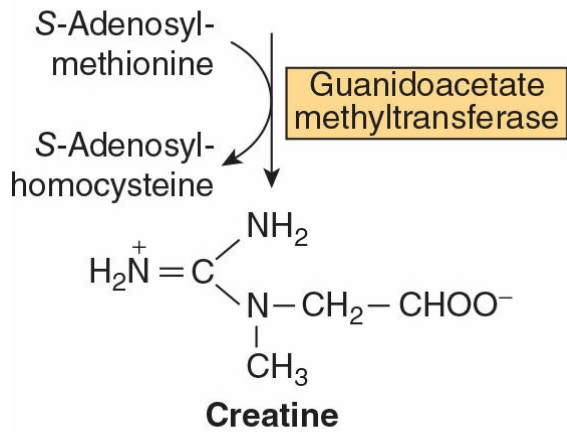
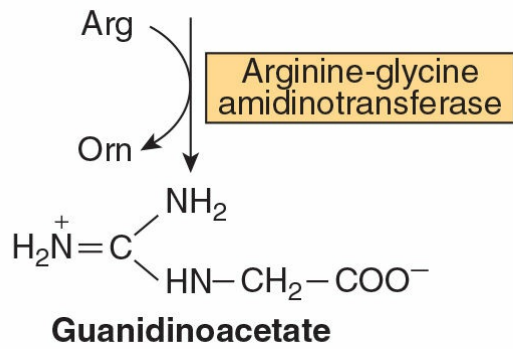
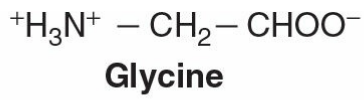

FIGURE 30–12 Biosynthesis of creatine and creatinine. Conversion of glycine and the guanidine group of arginine to creatine and creatine phosphate. Also shown is the nonenzymic hydrolysis of creatine phosphate to creatinine.

NON- α -AMINO ACIDS

Non- α -amino acids present in tissues in a free form include β -alanine, β -aminoisobutyrate, and GABA. β -Alanine is also present in combined form in coenzyme A, and in the β -alanyl dipeptides carnosine, anserine, and homocarnosine (see below).

β -Alanine & β -Aminoisobutyrate

β -Alanine and β -aminoisobutyrate are formed during catabolism of the pyrimidines uracil and thymine, respectively (see [Figure 33–9](#)). Traces of β -alanine also result from the hydrolysis of β -alanyl dipeptides by the enzyme carnosinase, EC 3.4.13.20. β -Aminoisobutyrate also arises by transamination of methylmalonate semialdehyde, a catabolite of L-valine (see [Figure 29–22](#)).

The initial reaction of β -alanine catabolism is transamination to malonate semialdehyde. Subsequent transfer of coenzyme A from succinyl-CoA forms malonyl-CoA semialdehyde, which is then oxidized to malonyl-CoA and decarboxylated to the amphibolic intermediate acetyl-CoA. Analogous reactions characterize the catabolism of β -aminoisobutyrate. Transamination forms methylmalonate semialdehyde, which is converted to the amphibolic intermediate succinyl-CoA by reactions 8V and 9V of [Figure 29–22](#). Disorders of β -alanine and β -aminoisobutyrate metabolism arise from defects in enzymes of the pyrimidine catabolic pathway. Principal among these are disorders that result from a total or partial deficiency of dihydropyrimidine dehydrogenase (see [Chapter 33](#)).

β -Alanyl Dipeptides

The β -alanyl dipeptides carnosine and anserine (*N*-methyl-carnosine) ([Figure 30–6](#)) activate myosin ATPase (EC 3.6.4.1), chelate copper, and enhance copper uptake. β -Alanyl-imidazole buffers the pH of anaerobically contracting skeletal muscle. Biosynthesis of carnosine is catalyzed by carnosine synthetase (EC 6.3.2.11) in a two-stage reaction

that involves initial formation of an enzyme-bound acyl-adenylate of β -alanine and subsequent transfer of the β -alanyl moiety to L-histidine.

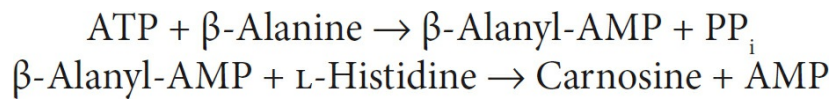

Hydrolysis of carnosine to β -alanine and L-histidine is catalyzed by carnosinase. The heritable disorder carnosinase deficiency is characterized by **carnosinuria**.

Homocarnosine (Figure 30–6, present in human brain at higher levels than carnosine, is synthesized in brain tissue by carnosine synthetase. Serum carnosinase does not hydrolyze homocarnosine.

Homocarnosinosis, a rare genetic disorder, is associated with progressive spastic paraplegia and mental retardation.

γ -Aminobutyrate

GABA functions in brain tissue as an inhibitory neurotransmitter by altering transmembrane potential differences. GABA is formed by decarboxylation of glutamate by L-glutamate decarboxylase, EC 4.1.1.15 (Figure 30–13). Transamination of GABA forms succinate semialdehyde, which can be reduced to γ -hydroxybutyrate by L-lactate dehydrogenase, or be oxidized to succinate and thence via the citric acid cycle to CO_2 and H_2O (Figure 30–13). A rare genetic disorder of GABA metabolism involves a defective GABA aminotransferase EC 2.6.1.19, an enzyme that participates in the catabolism of GABA subsequent to its postsynaptic release in brain tissue. Defects in succinic semialdehyde dehydrogenase, EC 1.2.1.24 (Figure 30–13) are responsible for **4-hydroxybutyric aciduria**, a rare metabolic disorder of GABA catabolism characterized by the presence of 4-hydroxybutyrate in urine, plasma, and cerebrospinal fluid (CSF). No present treatment is available for the accompanying mild-to-severe neurologic symptoms.

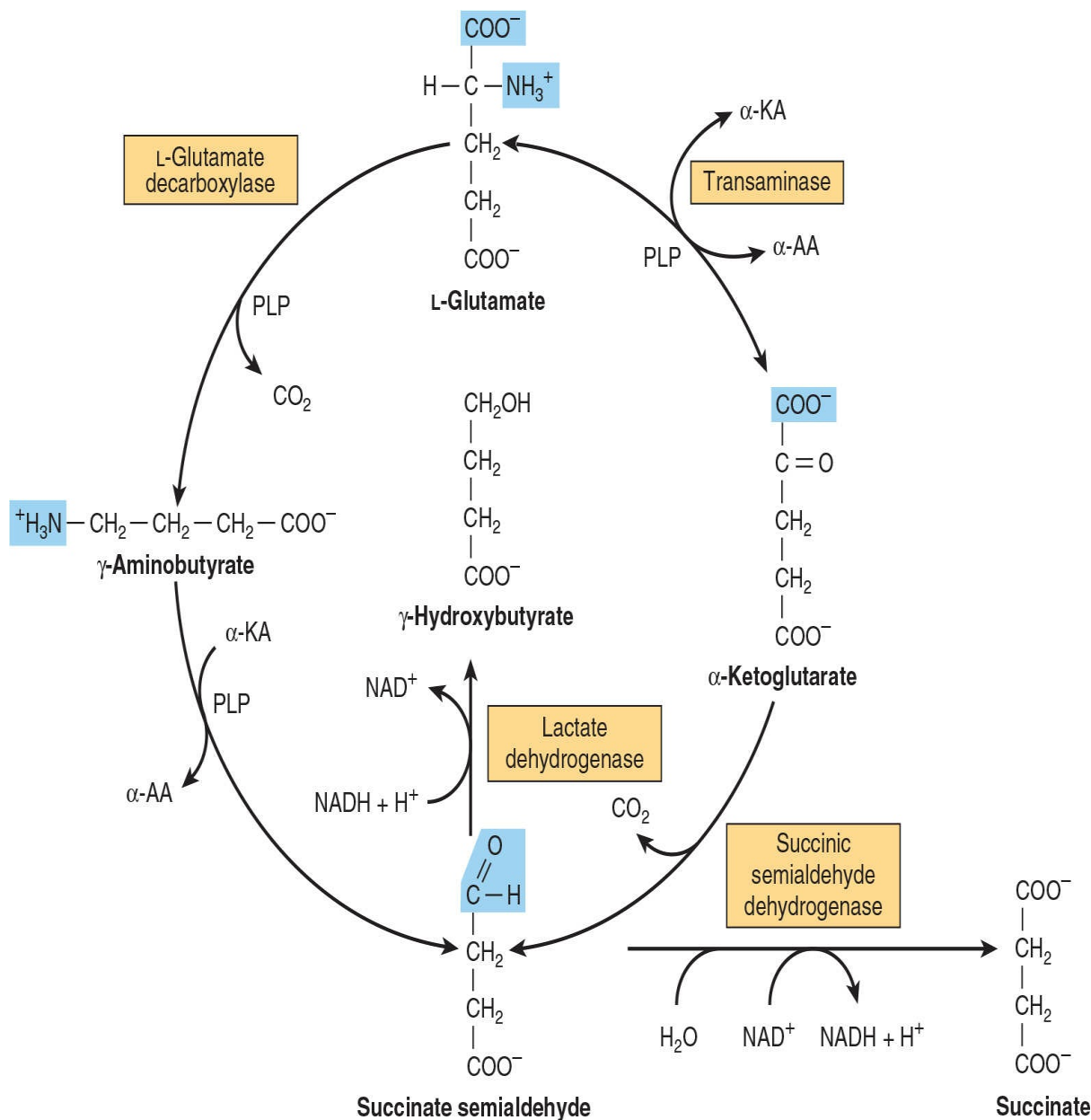

FIGURE 30–13 Metabolism of γ -aminobutyrate. (α -AA, α -amino acids; α -KA, α -keto acids; PLP, pyridoxal phosphate.)

SUMMARY

- In addition to serving structural and functional roles in proteins, α -amino acids participate in a wide variety of other biosynthetic processes.
- Arginine provides the formamidine group of creatine and the nitrogen of NO. Via ornithine, arginine provides the skeleton of the polyamines putrescine, spermine, and spermidine.
- Cysteine provides the thioethanolamine portion of coenzyme A, and

following its conversion to taurine, is part of the bile acid taurocholic acid.

- Glycine participates in the biosynthesis of heme, purines, creatine, and *N*-methylglycine (sarcosine). Many drugs and drug metabolites are excreted as glycine conjugates. This enhances their water solubility for urinary excretion.
- Decarboxylation of histidine forms the neurotransmitter histamine. Histidine compounds present in the human body include ergothioneine, carnosine, and anserine.
- *S*-Adenosylmethionine, the principal source of methyl groups in metabolism, contributes its carbon skeleton to the biosynthesis of the polyamines spermine and spermidine.
- In addition to its roles in phospholipid and sphingosine biosynthesis, serine provides carbons 2 and 8 of purines and the methyl group of thymine.
- Key tryptophan metabolites include serotonin and melatonin. Kidney and liver tissue, and also fecal bacteria, convert tryptophan to tryptamine and thence to indole 3-acetate. The principal tryptophan catabolites in urine are indole 3-acetate and 5-hydroxyindoleacetate.
- Tyrosine forms norepinephrine and epinephrine, and following iodination the thyroid hormones triiodothyronine and thyroxine.
- The enzyme-catalyzed interconversion of the phospho- and dephospho- forms of peptide-bound serine, threonine, and tyrosine plays key roles in metabolic regulation, including signal transduction.
- Glycine, arginine, and *S*-adenosylmethionine all participate in the biosynthesis of creatine, which as creatine phosphate serves as a major energy reserve in muscle and brain tissue. Excretion in the urine of its catabolite creatinine is proportionate to muscle mass.
- β -Alanine and β -aminoisobutyrate both are present in tissues as free amino acids. β -Alanine also occurs in bound form in coenzyme A, carnosine, anserine, and homocarnosine. Catabolism of β -alanine involves stepwise conversion to acetyl-CoA. Analogous reactions catabolize β -aminoisobutyrate to succinyl-CoA. Disorders of β -alanine and β -aminoisobutyrate metabolism arise from defects in enzymes of pyrimidine catabolism.
- Decarboxylation of glutamate forms the inhibitory neurotransmitter GABA. Two rare metabolic disorders are associated with defects in GABA catabolism.

REFERENCES

- Allen GF, Land JM, Heales SJ: A new perspective on the treatment of aromatic L-amino acid decarboxylase deficiency. *Mol Genet Metab* 2009;97:6.
- Caine C, Shohat M, Kim JK, et al: A pathogenic S250F missense mutation results in a mouse model of mild aromatic L-amino acid decarboxylase (AADC) deficiency. *Hum Mol Genet* 2017;26:4406.
- Cravedi E, Deniau E, Giannitelli M, et al: Tourette syndrome and other neurodevelopmental disorders: a comprehensive review. *Child Adolesc Psychiatry Ment Health* 2017;11:59.
- Jansen EE, Vogel KR, Salomons GS, et al: Correlation of blood biomarkers with age informs pathomechanisms in succinic semialdehyde dehydrogenase deficiency (SSADHD), a disorder of GABA metabolism. *J Inherit Metab Dis* 2016;39:795.
- Manegold C, Hoffmann GF, Degen I, et al: Aromatic L-amino acid decarboxylase deficiency: clinical features, drug therapy and followup. *J Inherit Metab Dis* 2009;32:371.
- Moinard C, Cynober L, de Bandt JP: Polyamines: metabolism and implications in human diseases. *Clin Nutr* 2005;24:184.
- Montioli R, Dindo M, Giorgetti A, et al: A comprehensive picture of the mutations associated with aromatic amino acid decarboxylase deficiency: from molecular mechanisms to therapy implications. *Hum Mol Genet* 2014;23:5429.
- Pearl PL, Gibson KM, Cortez MA, et al: Succinic semialdehyde dehydrogenase deficiency: lessons from mice and men. *J Inherit Metab Dis* 2009;32:343.
- Schippers KJ, Nichols SA: Deep, dark secrets of melatonin in animal evolution. *Cell* 2014;159:9.
- Wernli C, Finochiaro S, Volken C, et al: Targeted screening of succinic semialdehyde dehydrogenase deficiency (SSADHD) employing an enzymatic assay for γ -hydroxybutyric acid (GHB) in biofluids. *Mol Genet Metab Rep*. 2016;17:81.

Porphyrins & Bile Pigments

Victor W. Rodwell, PhD & Robert K. Murray, MD, PhD

OBJECTIVES

After studying this chapter, you should be able to:

- Write the structural formulas of the two amphibolic intermediates whose condensation initiates heme biosynthesis.
- Identify the enzyme that catalyzes the key regulated enzyme of hepatic heme biosynthesis.
- Explain why, although porphyrinogens and porphyrins both are tetrapyrroles, porphyrins are colored whereas porphyrinogens are colorless.
- Specify the intracellular locations of the enzymes and metabolites of heme biosynthesis.
- Outline the causes and clinical presentations of various porphyrias.
- Identify the roles of heme oxygenase and of UDP-glucosyl transferase in heme catabolism.
- Define jaundice, name some of its causes, and suggest how to determine its biochemical basis.
- Specify the biochemical basis of the clinical laboratory terms “direct bilirubin” and “indirect bilirubin.”

BIOMEDICAL IMPORTANCE

The biochemistry of the porphyrins and of the bile pigments are closely related topics. Heme is synthesized from porphyrins and iron, and the products of degradation of heme are the bile pigments and iron. The biochemistry of the porphyrins and of heme is basic to understanding the varied functions of **hemoproteins**, and the **porphyrias**, a group of diseases caused by abnormalities in the pathway of porphyrin biosynthesis. A much more common clinical condition is **jaundice**, a consequence of an elevated level of plasma bilirubin, due either to overproduction of bilirubin or to failure of its excretion. Jaundice occurs in numerous diseases ranging from hemolytic anemias to viral hepatitis and to cancer of the pancreas.

PORPHYRINS

Porphyrins are cyclic compounds formed by the linkage of four **pyrrole rings** through methyne (—HC—) bridges (**Figure 31–1**). Various **side chains** can replace the eight numbered hydrogen atoms of the pyrrole rings.

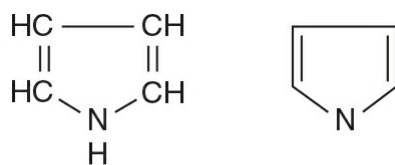

Pyrrole

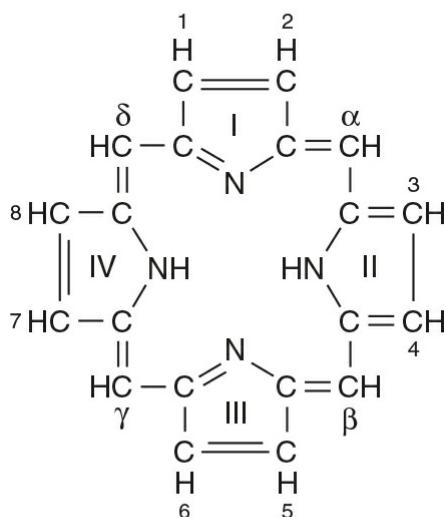

Porphyrin
($C_{20}H_{14}N_4$)

FIGURE 31–1 The porphyrin molecule. Rings are labeled I, II, III, and IV. Substituent positions are labeled 1 through 8. The four methyne bridges (=HC—) are labeled α , β , γ , and δ .

Porphyrins can form complexes with metal ions that form coordinate bonds to the nitrogen atom of each of the four pyrrole rings. Examples include **iron porphyrins** such as the **heme** of hemoglobin and the **magnesium-containing porphyrin chlorophyll**, the photosynthetic pigment of plants. Heme proteins are ubiquitous in biology and serve diverse functions including, but not limited to, oxygen transport and storage (eg, hemoglobin and myoglobin) and electron transport (eg, cytochrome c and cytochrome P450). Hemes are **tetrapyrroles**, of which two types, heme *b* and heme *c*, predominate (**Figure 31–2**). In heme *c* the vinyl groups of heme *b* are replaced by covalent thioether links to an apoprotein, typically via cysteinyl residues. Unlike heme *b*, heme *c* thus does not readily dissociate from its apoprotein.

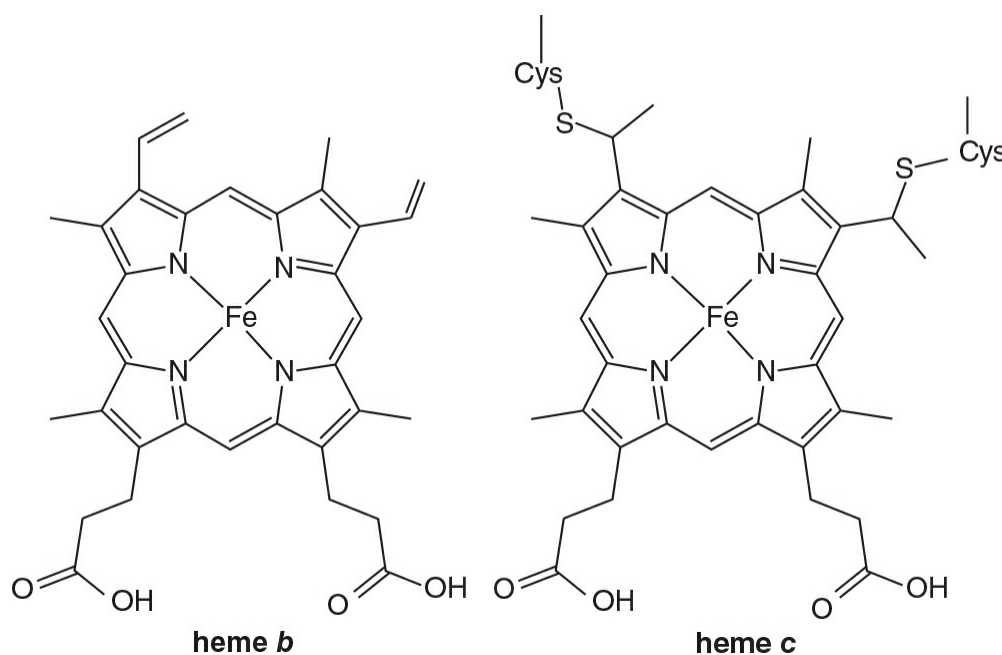

FIGURE 31–2 Structures of heme *b* and heme *c*.

Proteins that contain heme are widely distributed in nature (**Table 31–1**). Vertebrate heme proteins generally bind one mole of heme *c* per mole, although those of nonvertebrates may bind significantly more heme.

TABLE 31–1 Examples of Important Heme Proteins^a

Protein	Function
Hemoglobin	Transport of oxygen in blood
Myoglobin	Storage of oxygen in muscle
Cytochrome <i>c</i>	Involvement in the electron transport chain
Cytochrome P450	Hydroxylation of xenobiotics
Catalase	Degradation of hydrogen peroxide
Tryptophan pyrrolase	Oxidation of tryptophan

^aThe functions of the above proteins are described in various chapters of this text.

HEME IS SYNTHESIZED FROM SUCCINYL-CoA & GLYCINE

The biosynthesis of heme involves both cytosolic and mitochondrial reactions and intermediates. Heme biosynthesis occurs in most mammalian cells except mature erythrocytes, which lack mitochondria. Approximately 85% of heme synthesis occurs in erythroid precursor cells in the **bone marrow**, and the majority of the remainder in **hepatocytes**. Heme biosynthesis is initiated by the condensation of succinyl-CoA and glycine in a pyridoxal phosphate-dependent reaction catalyzed by mitochondrial **δ -aminolevulinic acid synthase (ALA synthase, EC 2.3.1.37)**.

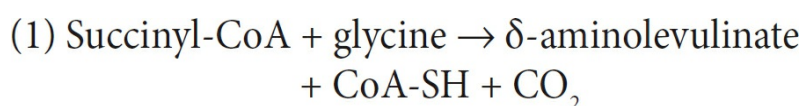

Humans express two isozymes of ALA synthase. ALAS1 is ubiquitously expressed throughout the body, whereas ALAS2 is expressed in erythrocyte precursor cells. Formation of δ -aminolevulinic acid is rate-limiting for porphyrin biosynthesis in mammalian liver (**Figure 31–3**).

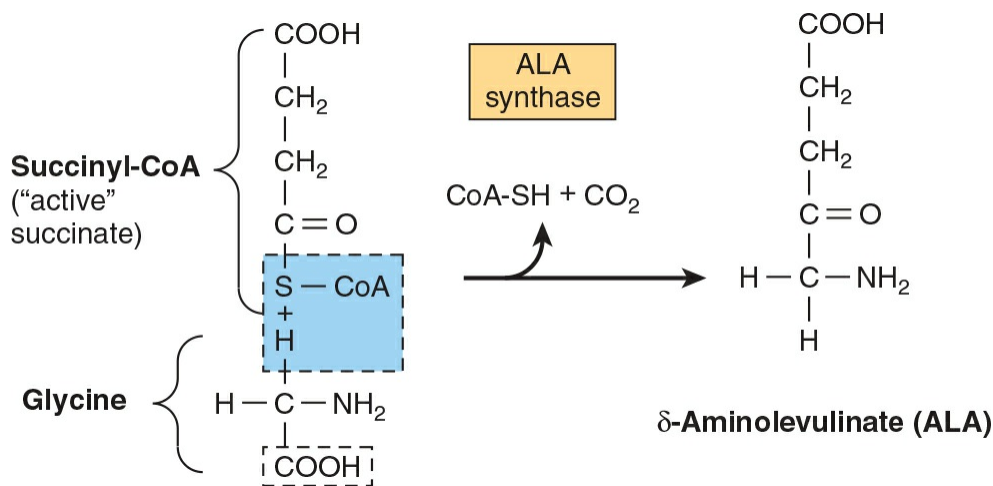
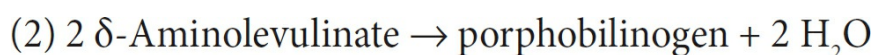

FIGURE 31–3 Synthesis of δ -aminolevulinic acid (ALA). This mitochondrial reaction is catalyzed by ALA synthase.

Following the exit of δ -aminolevulinic acid into the cytosol, the reaction catalyzed by cytosolic **ALA dehydratase** (EC 4.2.1.24; porphobilinogen synthase) condenses two molecules of ALA, forming **porphobilinogen**:



(Figure 31–4). A zinc metalloprotein, ALA dehydratase is sensitive to inhibition by **lead**, as can occur in lead poisoning.

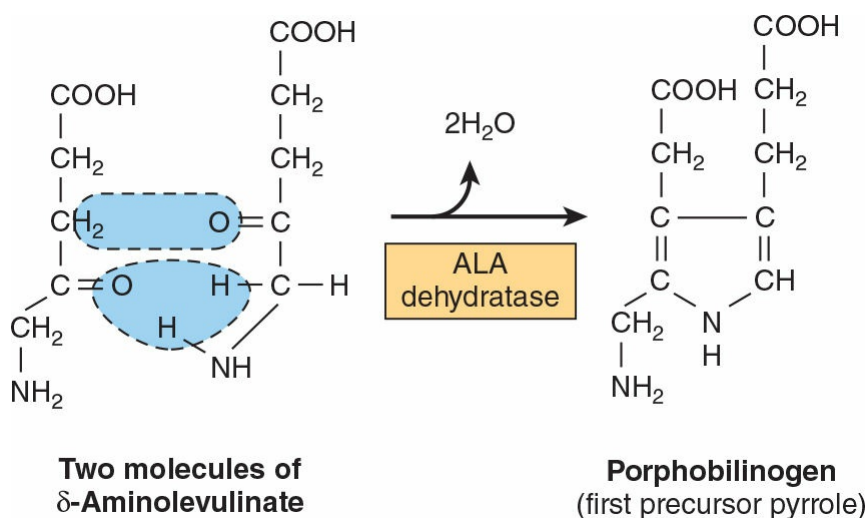

FIGURE 31–4 Formation of porphobilinogen. Cytosolic porphobilinogen synthase converts two molecules of δ -aminolevulinic acid to porphobilinogen.

The third reaction, catalyzed by *cytosolic hydroxymethylbilane synthase* (uroporphyrinogen I synthase, EC 2.5.1.61) involves head-to-tail

condensation of four molecules of porphobilinogen to form the *linear* tetrapyrrole **hydroxymethylbilane** (Figure 31–5, top):

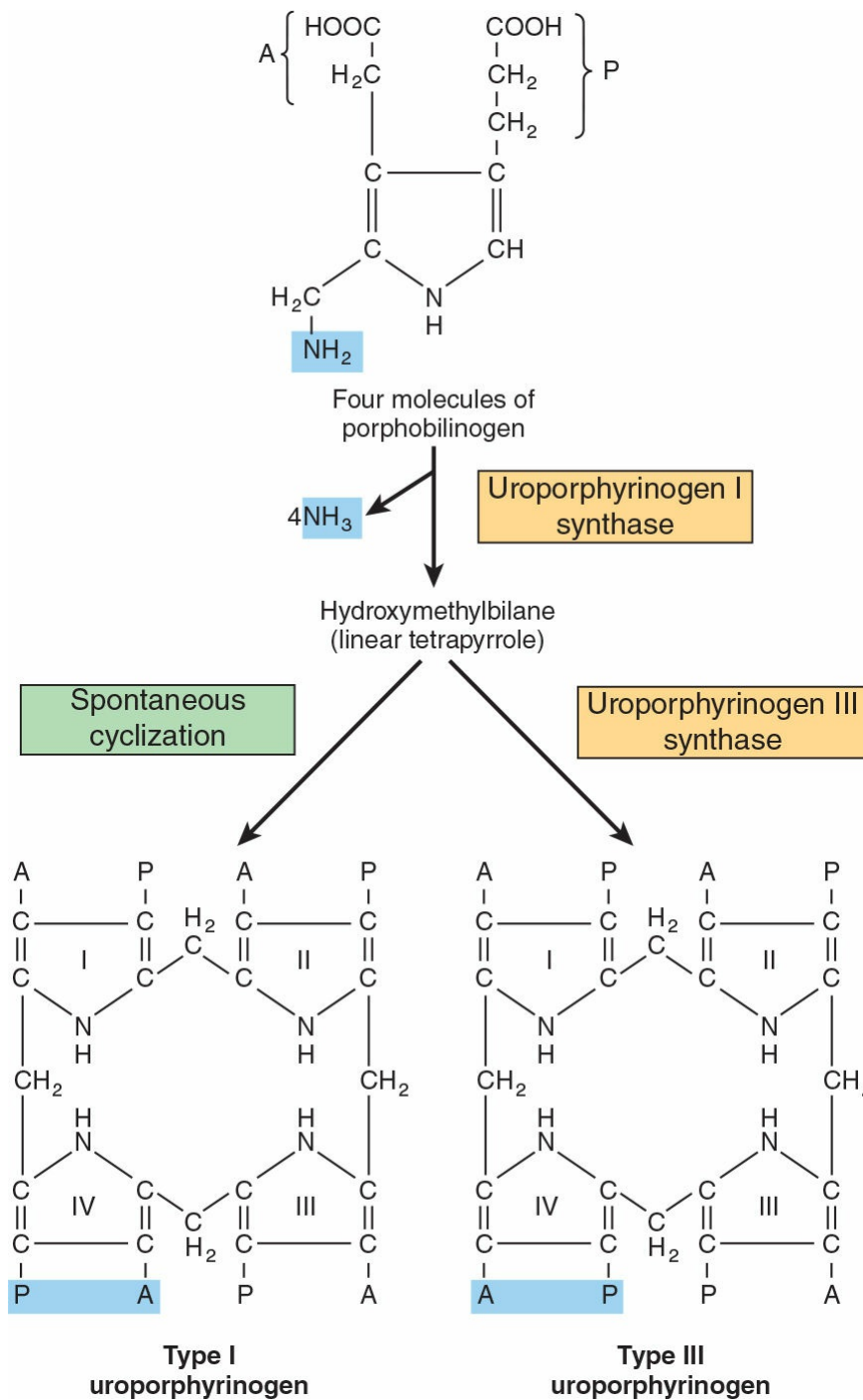
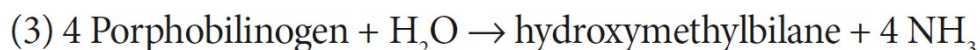
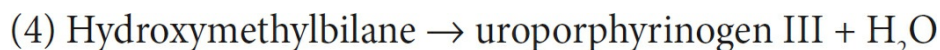

FIGURE 31–5 Synthesis of hydroxymethylbilane and its subsequent cyclization to porphobilinogen III. *Cytosolic* hydroxymethylbilane synthase (ALA dehydratase) forms a linear tetrapyrrole, which *cytosolic* uroporphyrinogen synthase cyclizes to form **uroporphyrinogen III**. Notice the asymmetry of the substituents on ring 4, so that the highlighted acetate and propionate substituents are reversed in uroporphyrinogens I

and III. (A, acetate [$-\text{CH}_2\text{COO}^-$]; P, propionate [$-\text{CH}_2\text{CH}_2\text{COO}^-$].)



Subsequent cyclization of hydroxymethylbilane, catalyzed by cytosolic **uroporphyrinogen III synthase**, EC 4.2.1.75:



forms **uroporphyrinogen III** (Figure 31–5, *bottom right*).

Hydroxymethylbilane can undergo spontaneous cyclization forming **uroporphyrinogen I** (Figure 31–5, *bottom left*), but under normal conditions, the uroporphyrinogen formed is almost exclusively the type III isomer. The type I isomers of porphyrinogens are, however, formed in excess in certain porphyrias. Since the pyrrole rings of these uroporphyrinogens are connected by **methylene** ($-\text{CH}_2-$) rather than by methyne bridges ($-\text{HC}-$), the double bonds do not form a conjugated system. **Porphyrinogens** thus are **colorless**. They are, however, readily auto-oxidized to **colored porphyrins**.

All four acetate moieties of uroporphyrinogen III next undergo decarboxylation to methyl (M) substituents, forming **coproporphyrinogen III** in a cytosolic reaction catalyzed by **uroporphyrinogen decarboxylase**, EC 4.1.1.37 (Figure 31–6):

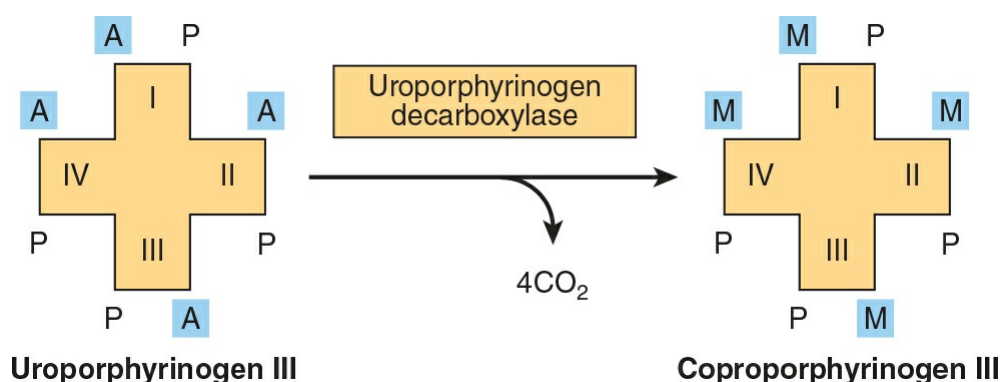

FIGURE 31–6 Decarboxylation of uroporphyrinogen III to coproporphyrinogen III. Shown is a representation of the tetrapyrrole to emphasize the conversion of four attached acetyl groups to methyl groups. (A, acetyl; M, methyl; P, propionyl.)



This decarboxylase can also convert uroporphyrinogen I, if present, to

coproporphyrinogen I.

The final three reactions of heme biosynthesis all occur in mitochondria. Coproporphyrinogen III enters the mitochondria and is converted, successively, to **protoporphyrinogen III**, and then to **protoporphyrin III**. These reactions are catalyzed by **coproporphyrinogen oxidase** (EC 1.3.3.3), which decarboxylates and oxidizes the two propionic acid side chains to form **protoporphyrinogen III**:



This oxidase is specific for type III coproporphyrinogen, so type I protoporphyrins generally do not occur in humans. Protoporphyrinogen III is next oxidized to **protoporphyrin III** in a reaction catalyzed by **protoporphyrinogen oxidase**, EC 1.3.3.4:

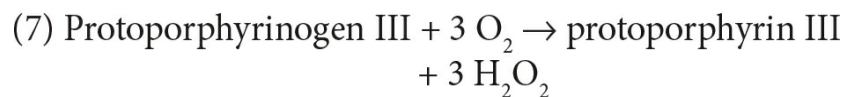

The eighth and final step in heme synthesis involves the incorporation of ferrous iron into protoporphyrin III in a reaction catalyzed by **ferrochelatase** (heme synthase, EC 4.99.1.1), ([Figure 31–7](#)):

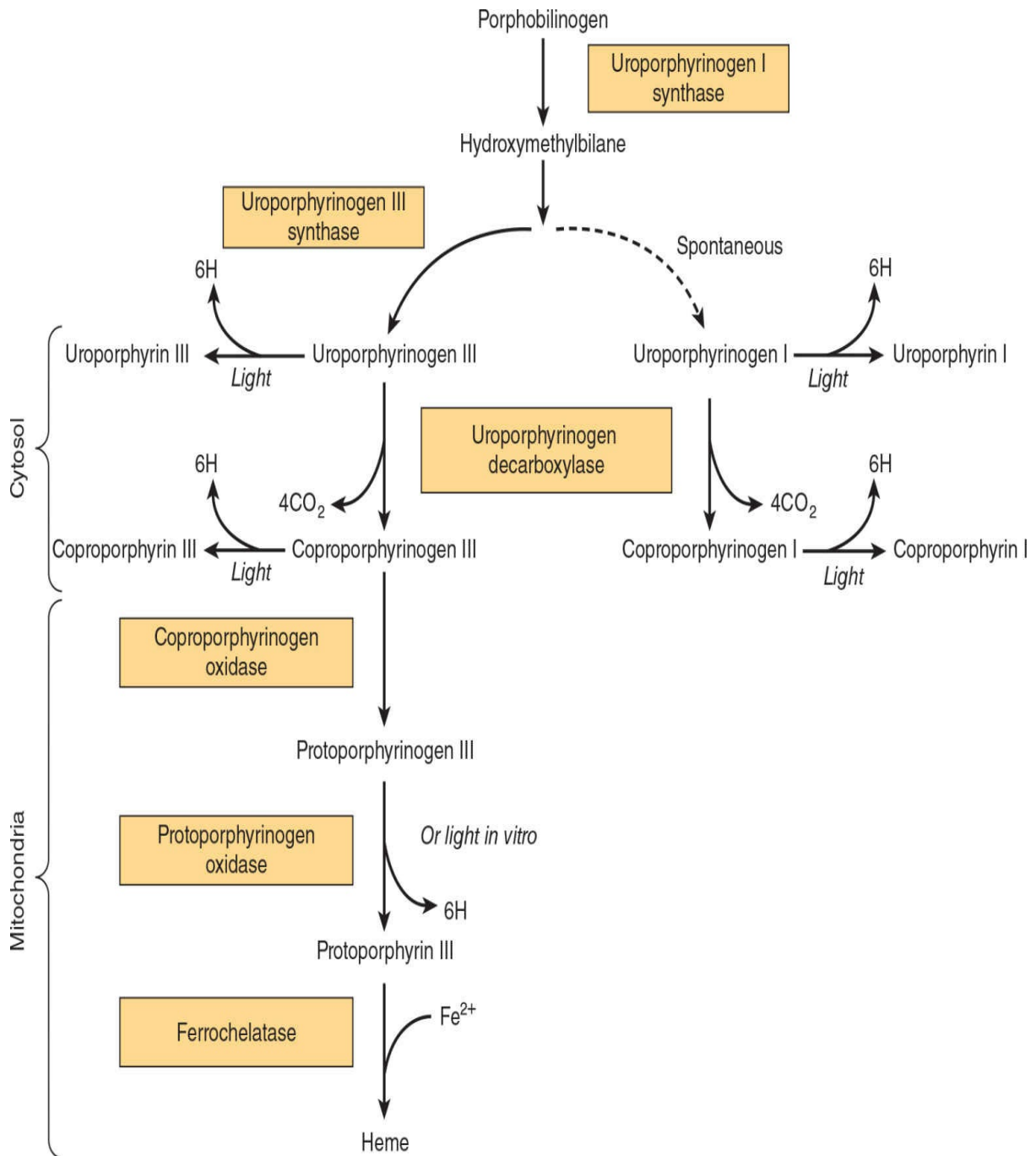

FIGURE 31–7 Biosynthesis from porphobilinogen of the indicated porphyrin derivatives.



Figure 31–8 summarizes the stages of the biosynthesis of the porphyrin derivatives from porphobilinogen. For the above reactions, numbers correspond to those in **Figure 31–8** and in **Table 31–2**.

TABLE 31–2 Summary of Major Findings in the Porphyrrias^a

Enzyme Involved ^b	Type, Class, and OMIM Number	Major Signs and Symptoms	Results of Laboratory Tests
1. ALA synthase 2 (ALAS2), EC 2.3.1.37	X-linked sideroblastic anemia ^c (erythropoietic) (OMIM 301300)	Anemia	Red cell counts and hemoglobin decreased
2. ALA dehydratase EC 4.2.1.24	ALA dehydratase deficiency (hepatic) (OMIM 125270)	Abdominal pain, neuropsychiatric symptoms	Urinary ALA and coproporphyrin III increased
3. Uroporphyrinogen I synthase ^d EC 2.5.1.61	Acute intermittent porphyria (hepatic) (OMIM 176000)	Abdominal pain, neuropsychiatric symptoms	Urinary ALA and PBG ^e increased
4. Uroporphyrinogen III synthase EC 4.2.1.75	Congenital erythropoietic (erythropoietic) (OMIM 263700)	Photosensitivity	Urinary, fecal, and red cell uroporphyrin I increased
5. Uroporphyrinogen decarboxylase EC 4.1.1.37	Porphyria cutaneatarda (hepatic) (OMIM 176100)	Photosensitivity	Urinary uroporphyrin I increased
6. Coproporphyrinogen oxidase EC 1.3.3.3	Hereditary coproporphyria (hepatic) (OMIM 121300)	Photosensitivity, abdominal pain, neuropsychiatric symptoms	Urinary ALA, PBG, and coproporphyrin III and fecal coproporphyrin III increased
7. Protoporphyrinogen oxidase EC 1.3.3.4	Variegate porphyria (hepatic) (OMIM 176200)	Photosensitivity, abdominal pain, neuropsychiatric symptoms	Urinary ALA, PBG, and coproporphyrin III and fecal protoporphyrin IX increased
8. Ferrochelatase EC 4.99.1.1	Protoporphyria (erythropoietic) (OMIM 177000)	Photosensitivity	Fecal and red cell protoporphyrin IX increased

^aOnly the biochemical findings in the active stages of these diseases are listed. Certain biochemical abnormalities are detectable in the latent stages of some of the above conditions. Conditions 3, 5, and 8 are generally the most prevalent porphyrias. Condition 2 is rare.

^bThe numbering of the enzymes in this Table corresponds to that used in Figure 31-8.

^cX-linked sideroblastic anemia is not a porphyria but is included here because ALA synthase is involved.

^dThis enzyme is also called PBG deaminase or hydroxymethylbilane synthase.

^ePBG = porphobilinogen III.

Abbreviations: ALA, δ -aminolevulinic acid; PBG, porphobilinogen.

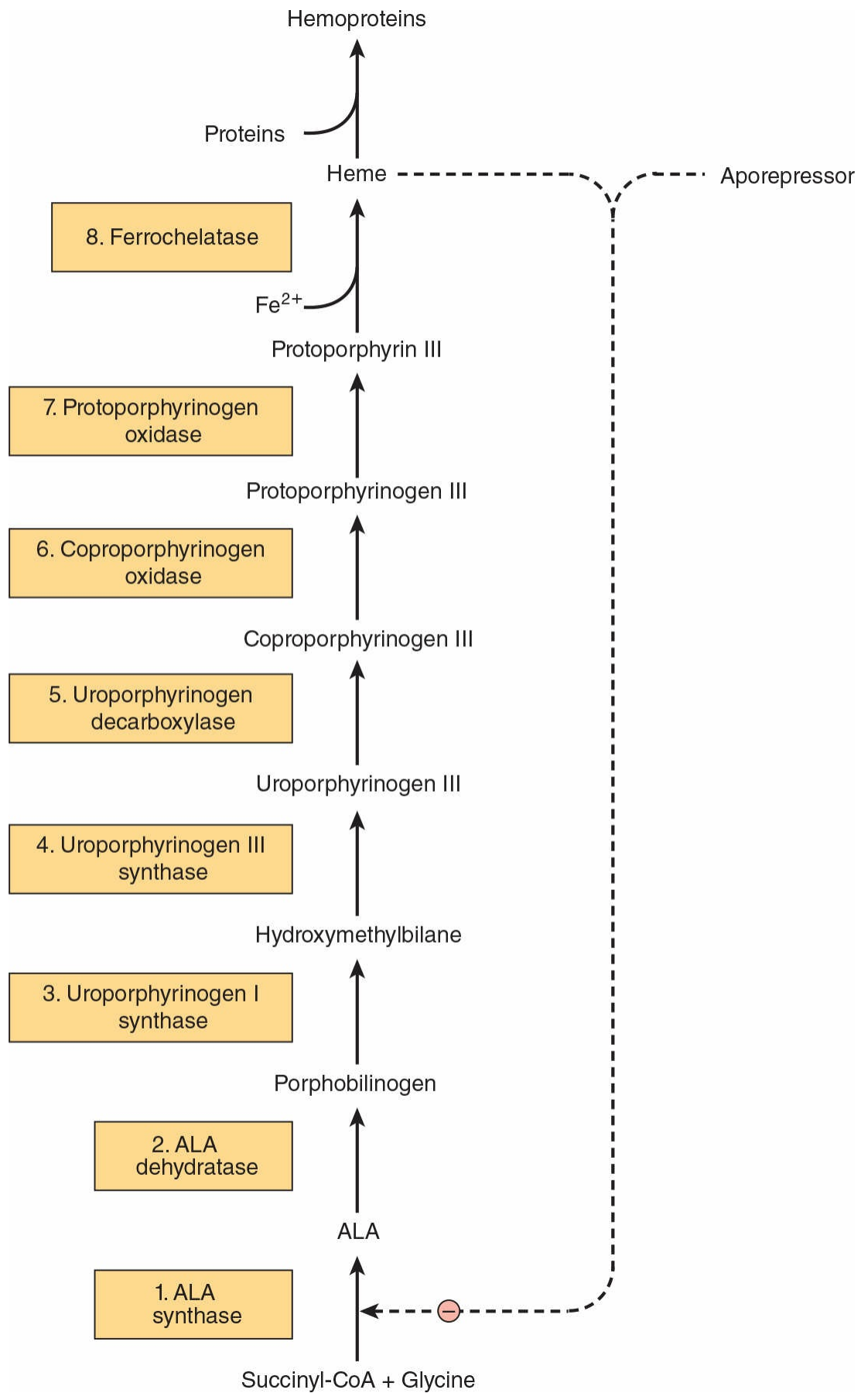

FIGURE 31–8 Intermediates, enzymes, and regulation of heme synthesis. The numbers of the enzymes that catalyze the indicated reactions are those used in the accompanying text and in column 1 of **Table 31–2**. Enzymes 1, 6, 7, and 8 are *mitochondrial*, but enzymes 2 to 5 are *cytosolic*. Regulation of hepatic heme synthesis occurs at ALA synthase (ALAS1) by a repression–derepression mechanism mediated by heme and a hypothetical aporepressor (not shown). Mutations in the gene encoding enzyme 1 cause X-linked sideroblastic anemia. Mutations in the genes encoding enzymes 2 to 8 give rise to the porphyrias.

ALA Synthase Is the Key Regulatory Enzyme in Hepatic Biosynthesis of Heme

Unlike ALAS2, which is expressed exclusively in erythrocyte precursor cells, ALAS1 is expressed throughout body tissues. The reaction catalyzed by ALA synthase 1 (**Figure 31–3**) is rate-limiting for biosynthesis of heme in liver. Typically for an enzyme that catalyzes a rate-limiting reaction, ALAS1 has a short half-life. **Heme**, probably acting through an aporepressor molecule, acts as a **negative regulator** of the synthesis of ALAS1 (**Figure 31–8**). Synthesis of ALAS1 thus increases greatly in the *absence* of heme, but diminishes in its *presence*. Heme also affects translation of ALAS1 and its translocation from its cytosolic site of synthesis into the mitochondrion. Many drugs whose metabolism requires the hemoprotein cytochrome P450 increase cytochrome P450 biosynthesis. The resulting depletion of the intracellular heme pool induces synthesis of ALAS1, and the rate of heme synthesis rises to meet metabolic demand. By contrast, since ALAS2 is not feedback regulated by heme, its biosynthesis is not induced by these drugs.

PORPHYRINS ARE COLORED & FLUORESCES

While **porphyrinogens are colorless**, the various **porphyrins are colored**. The **conjugated double bonds** in the pyrrole rings and linking methylene groups of porphyrins (absent in the porphyrinogens) are responsible for their characteristic absorption and fluorescence spectra. The visible and the ultraviolet spectra of porphyrins and porphyrin derivatives are useful for their identification (**Figure 31–9**). The sharp absorption band **near 400 nm**, a distinguishing feature shared by all porphyrins, is termed the **Soret band** after its discoverer, the French physicist Charles Soret.

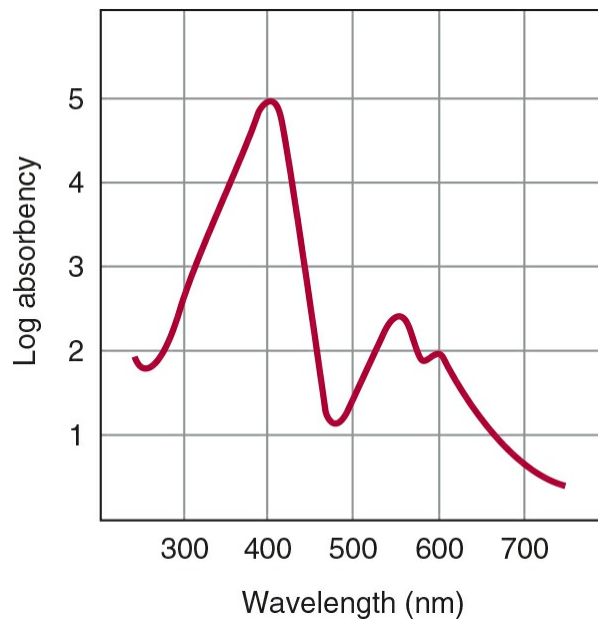

FIGURE 31–9 Absorption spectrum of hematoporphyrin. The spectrum is of a dilute (0.01%) solution of hematoporphyrin in 5% HCl.

Porphyrins dissolved in strong mineral acids or in organic solvents and illuminated by ultraviolet light emit a strong red **fluorescence**, a property often used to detect small amounts of free porphyrins. The photodynamic properties of porphyrins have suggested their possible use in the treatment of certain types of cancer, a procedure called **cancer phototherapy**. Since tumors often take up more porphyrins than do normal tissues, **hematoporphyrin** or related compounds are administered to a patient with an appropriate tumor. The tumor is then exposed to an **argon laser** to excite the porphyrins, producing cytotoxic effects.

Spectrophotometry Is Used to Detect Porphyrins & Their Precursors

Coproporphyrins and uroporphyrins are excreted in increased amounts in the **porphyrias**. When present in urine or feces, they can be separated by extraction with appropriate solvents, then identified and quantified using spectrophotometric methods.

DISORDERS OF HEME BIOSYNTHESIS

Disorders of heme biosynthesis may be genetic or acquired. An example of an acquired defect is lead poisoning. Lead can inactivate ferrochelatase and ALA dehydratase by combining with essential thiol groups. Signs

include elevated levels of protoporphyrin in erythrocytes and elevated urinary levels of ALA and coproporphyrin.

Genetic disorders of heme metabolism and of bilirubin metabolism (see below) share the following features with metabolic disorders of urea biosynthesis (see [Chapter 28](#)):

1. Similar or identical clinical signs and symptoms can arise from different mutations in genes that encode either a given enzyme or an enzyme that catalyzes a successive reaction.
2. Rational therapy requires an understanding of the biochemistry of the enzyme-catalyzed reactions in both normal and impaired individuals.
3. Identification of the intermediates and side products that accumulate prior to a metabolic block can provide the basis for metabolic screening tests that can implicate the impaired reaction.
4. Definitive diagnosis involves quantitative assay of the activity of the enzyme(s) suspected to be defective. To this might be added consideration of the as yet incompletely identified factors that facilitate translocation of enzymes and intermediates between cellular compartments.
5. Comparison of the DNA sequence of the gene that encodes a given mutant enzyme to that of the wild-type gene can identify the specific mutation(s) that cause the disease.

The Porphyrrias

The signs and symptoms of porphyria result either from a **deficiency** of intermediates beyond the enzymatic block, or from the **accumulation** of metabolites prior to the block. [Table 31–2](#) lists six major types of **porphyria** that reflect low or absent activity of enzymes that catalyze reactions 2 through 8 of [Figure 31–8](#). Possibly due to potential lethality, there is no known defect of ALAS1. Individuals with low ALAS2 activity develop anemia, not porphyria ([Table 31–2](#)). Porphyria consequent to low activity of ALA dehydratase, termed ALA dehydratase-deficient porphyria, is extremely rare.

Congenital Erythropoietic Porphyria

While most porphyrias are inherited in an **autosomal dominant manner**, congenital erythropoietic porphyria is inherited in a **recessive mode**. The

defective enzyme in congenital erythropoietic porphyria is **uroporphyrinogen III synthase** (Figure 31–5, bottom). The photosensitivity and severe disfigurement exhibited by some victims of congenital erythropoietic porphyria has suggested them as prototypes of so-called werewolves.

Acute Intermittent Porphyria

The defective enzyme in acute intermittent porphyria is hydroxymethylbilane synthase (Figure 31–5, bottom). ALA and porphobilinogen accumulate in body tissues and fluids (Figure 31–10).

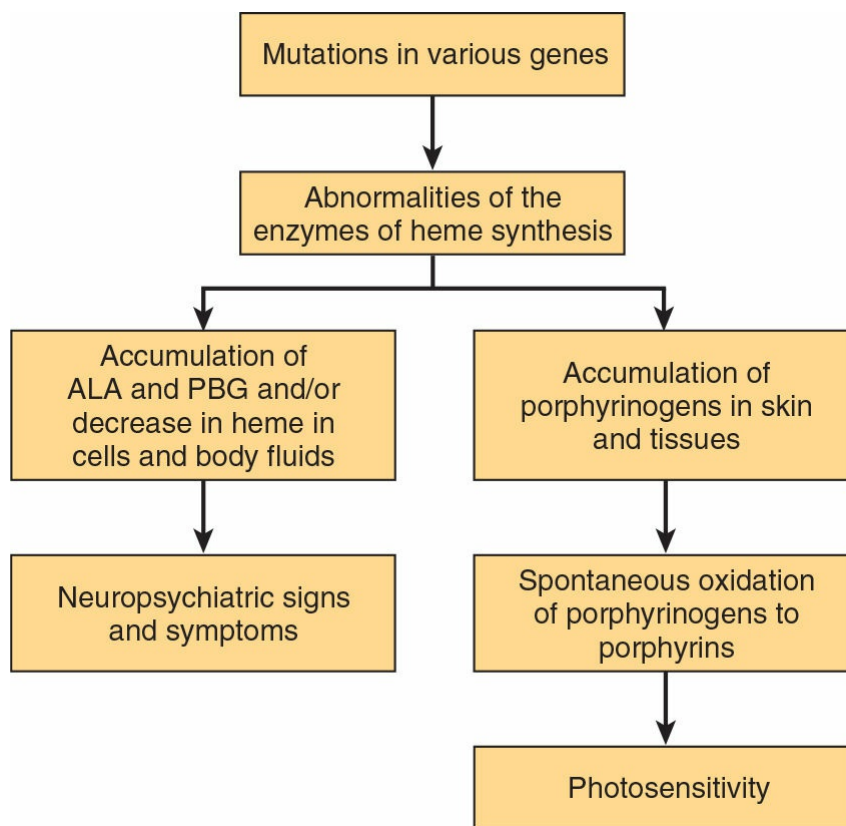

FIGURE 31–10 Biochemical basis of the major signs and symptoms of the porphyrias.

Subsequent Metabolic Blocks

Blocks later in the pathway result in the **accumulation of the porphyrinogens** indicated in Figures 31–8 and 31–10. Their oxidation products, the corresponding porphyrin derivatives, cause **photosensitivity** to visible light of about 400-nm wavelength. Possibly as a result of their excitation and reaction with molecular oxygen, the resulting oxygen

radicals injure lysosomes and other subcellular organelles, releasing proteolytic enzymes that cause variable degrees of skin damage, including scarring.

CLASSIFICATION OF THE PORPHYRIAS

Porphyrias may be termed **erythropoietic** or **hepatic** based on the organs most affected, typically bone marrow and the liver (Table 31–2). Different and variable levels of heme, toxic precursors, or metabolites probably account for why specific porphyrias differentially affect some cell types and organs. Alternatively, porphyrias may be classified as **acute** or **cutaneous** based on their clinical features. The diagnosis of a specific type of porphyria involves consideration of the clinical and family history, physical examination, and appropriate laboratory tests. Table 31–2 lists the major signs, symptoms, and relevant laboratory findings in the six principal types of porphyria.

Drug-Induced Porphyria

Certain drugs (eg, barbiturates, griseofulvin) induce the production of cytochrome P450. In patients with porphyria, this can precipitate an attack of porphyria by depleting heme levels. The compensating derepression of synthesis of ALAS1 then results in increased levels of potentially harmful heme precursors.

Possible Treatments for Porphyrias

Present treatment of porphyrias is essentially symptomatic: avoiding drugs that induce production of cytochrome P450, ingestion of large amounts of carbohydrate, and administration of hematin to repress ALAS1 synthesis to diminish production of harmful heme precursors. Patients exhibiting photosensitivity benefit from sunscreens and possibly from administered β -carotene, which appears to lessen production of free radicals, decreasing photosensitivity.

CATABOLISM OF HEME PRODUCES BILIRUBIN

Human adults normally destroy about 200 billion erythrocytes per day. A 70-kg human therefore turns over approximately **6 g of hemoglobin** daily. All products are reused. The **globin** is degraded to its constituent amino acids, and the released **iron** enters the iron pool. The iron-free **porphyrin**

portion of heme is also degraded, mainly in the reticuloendothelial cells of the liver, spleen, and bone marrow.

The catabolism of heme from all heme proteins takes place in the **microsomal fraction** of cells by **heme oxygenase**, EC 1.14.18.18. Heme oxygenase synthesis is substrate-inducible, and heme also serves both as a substrate and as a cofactor for the reaction. The iron of the heme that reaches heme oxygenase has usually been oxidized to its **ferric form (hemin)**. Conversion of one mole of heme-Fe³⁺ to biliverdin, carbon monoxide, and Fe³⁺ consumes three moles of O₂, plus seven electrons provided by NADH and NADPH–cytochrome P450 reductase:

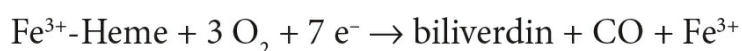

Despite its high affinity for heme-Fe²⁺ (see [Chapter 6](#)), the carbon monoxide produced does not severely inhibit heme oxygenase. Birds and amphibians excrete the green-colored biliverdin directly. In humans, **biliverdin reductase** (EC 1.3.1.24) reduces the central methylene bridge of biliverdin to a methyl group, producing the yellow-pigment **bilirubin** ([Figure 31–11](#)):

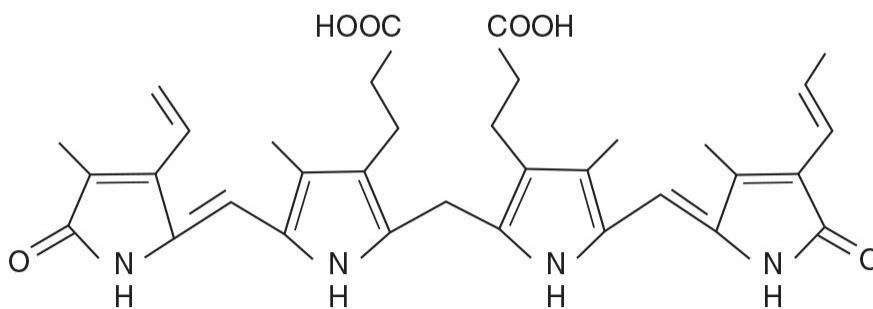
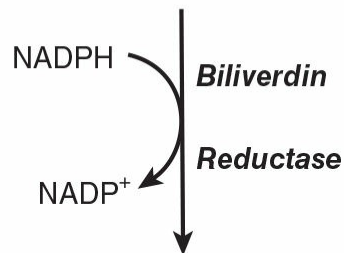
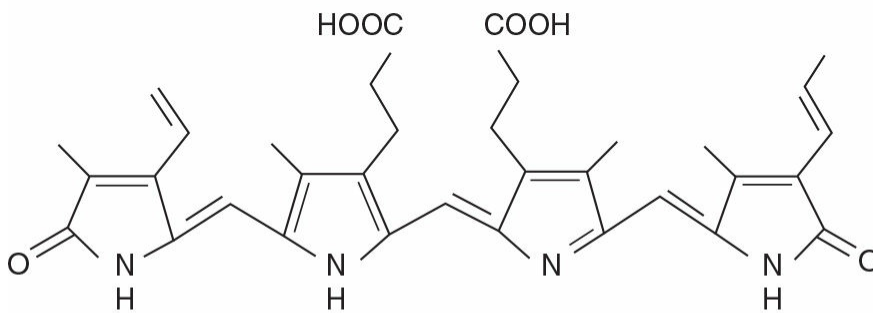
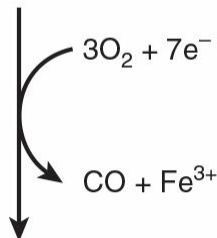
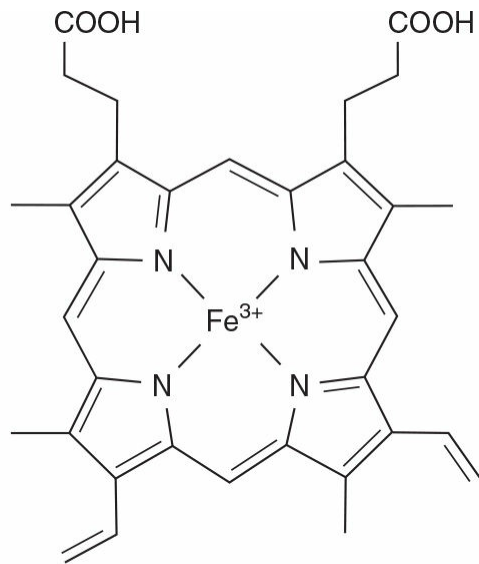

FIGURE 31–11 Conversion of ferric heme to biliverdin, and then to bilirubin. (1) Conversion of ferric heme to biliverdin is catalyzed by the heme oxygenase system. (2) Subsequently, biliverdin reductase reduces biliverdin to bilirubin.



Since 1 g of hemoglobin yields about 35 mg of bilirubin, **human adults form 250 to 350 mg of bilirubin per day**. This is derived principally from hemoglobin, and also from ineffective erythropoiesis and from catabolism of other heme proteins.

Conversion of heme to bilirubin by reticuloendothelial cells can be observed visually as the purple color of the heme in a **hematoma** slowly converts to the yellow pigment of bilirubin.

Bilirubin Is Transported to the Liver Bound to Serum Albumin

Unlike bilirubin, which is only sparingly water soluble, bilirubin bound to serum albumin is readily transported to the liver. Albumin appears to have both high-affinity and low-affinity sites for bilirubin. The high-affinity site can bind approximately 25 mg of bilirubin/100 mL of plasma. More loosely bound bilirubin can readily be detached and diffused into tissues, and antibiotics and certain other drugs can compete with and displace bilirubin from albumin's high-affinity site.

Further Metabolism of Bilirubin Occurs Primarily in the Liver

Hepatic catabolism of bilirubin takes place in three stages: uptake by the liver, conjugation with glucuronic acid, and secretion in the bile.

Uptake of Bilirubin by Liver Parenchymal Cells

Bilirubin is removed from albumin and taken up at the sinusoidal surface of hepatocytes by a large capacity, saturable **facilitated transport system**. Even under pathologic conditions, transport does not appear to be rate-limiting for the metabolism of bilirubin. The net uptake of bilirubin depends on its **removal** by subsequent metabolism. Once internalized, bilirubin binds to cytosolic proteins such as glutathione S-transferase,

previously known as a **ligandin**, to prevent bilirubin from reentering the bloodstream.

Conjugation of Bilirubin With Glucuronate

Bilirubin is **nonpolar**, and would persist in cells (eg, bound to lipids) if not converted to a more water-soluble form. Bilirubin is converted to a more **polar** molecule by conjugation with glucuronic acid (**Figure 31–12**). A bilirubin-specific **UDP-glucuronosyltransferase** (EC 2.4.1.17) of the endoplasmic reticulum catalyzes stepwise transfer to bilirubin of two glucosyl moieties from UDP-glucuronate:

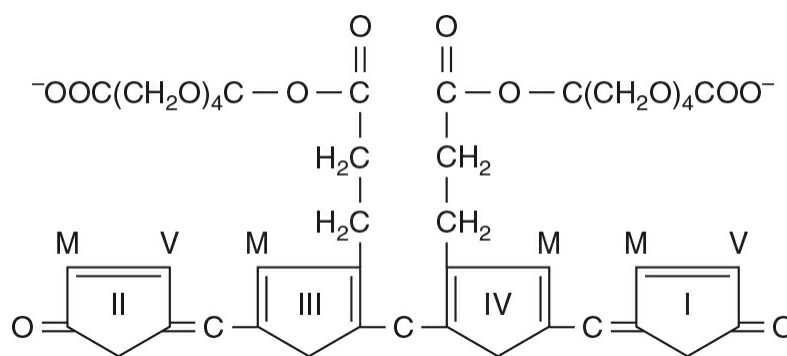
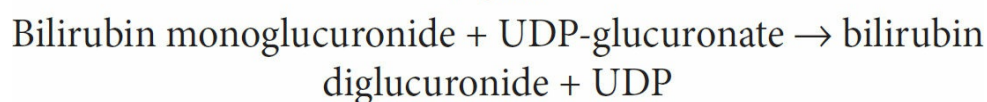
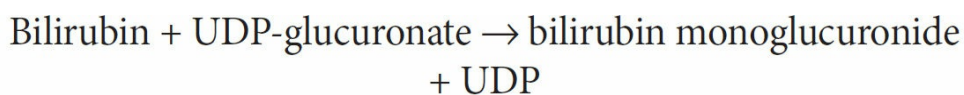

FIGURE 31–12 Bilirubin diglucuronide. Glucuronate moieties are attached via ester bonds to the two propionate groups of bilirubin. Clinically, the diglucuronide is also termed “direct reacting” bilirubin.



Secretion of Bilirubin Into the Bile

Secretion of conjugated bilirubin into the bile occurs by an **active transport** mechanism, which probably is rate-limiting for the entire process of hepatic bilirubin metabolism. The protein involved is a **multispecific organic anion transporter (MOAT)** located in the **plasma membrane** of the bile canaliculi. A member of the family of ATP-binding cassette transporters, MOAT transports a number of organic anions. The hepatic transport of conjugated bilirubin into the bile is **inducible** by the same drugs that can induce the conjugation of bilirubin. Conjugation and excretion of bilirubin thus constitute a coordinated functional unit.

Most of the bilirubin excreted in the bile of mammals is bilirubin diglucuronide. Bilirubin UDP-glucuronosyltransferase activity can be **induced** by several drugs, including phenobarbital. However, when bilirubin conjugates exist abnormally in human plasma (eg, in obstructive jaundice), they are predominantly **monoglucuronides**. **Figure 31–13** summarizes the three major processes involved in the transfer of bilirubin from blood to bile. Sites that are affected in a number of conditions causing jaundice are also indicated.

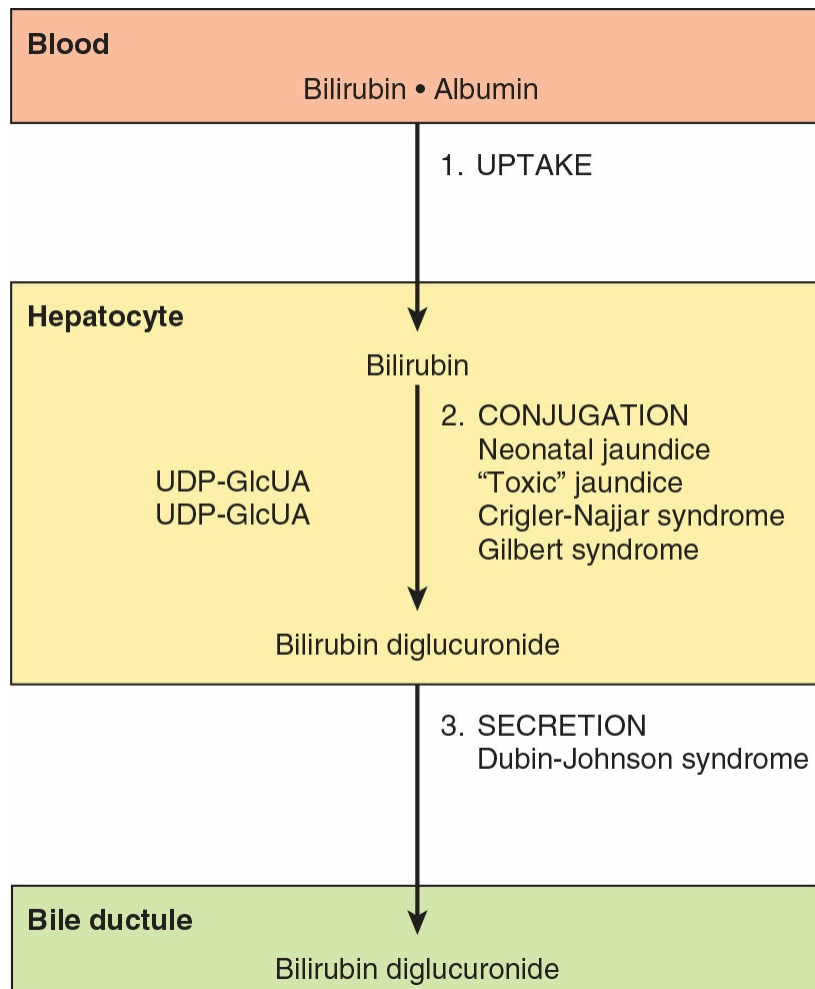

FIGURE 31–13 Diagrammatic representation of the three major processes (uptake, conjugation, and secretion) involved in the transfer of bilirubin from blood to bile. Certain proteins of hepatocytes bind intracellular bilirubin and may prevent its efflux into the bloodstream. The processes affected in certain conditions that cause jaundice are also shown.

Intestinal Bacteria Reduce Conjugated Bilirubin to Urobilinogen

When conjugated bilirubin reaches the terminal ileum and the large intestine, the glucuronosyl moieties are removed by specific bacterial **β -glucuronidases** (EC 3.2.1.31). Subsequent reduction by the fecal flora forms a group of colorless tetrapyrroles called **urobilinogens**. Small portions of urobilinogens are reabsorbed in the terminal ileum and large intestine and subsequently are reexcreted via the **enterohepatic urobilinogen cycle**. Under abnormal conditions, particularly when excessive bile pigment is formed or when liver disease disrupts this intrahepatic cycle, urobilinogen may also be excreted in the urine. Most of the colorless urobilinogens formed in the colon are **oxidized** there to colored **urobilins** and excreted in the feces. Fecal darkening upon standing in air results from the oxidation of residual urobilinogens to urobilins.

Measurement of Bilirubin in Serum

Quantitation of bilirubin employs a colorimetric method based on the reddish-purple color formed when bilirubin reacts with diazotized sulfanilic acid. An assay conducted in the *absence* of added methanol measures “**direct bilirubin**,” which is **bilirubin glucuronide**. An assay conducted in the *presence* of added methanol measures **total bilirubin**. The *difference* between total bilirubin and direct bilirubin is known as “**indirect bilirubin**,” and is **unconjugated bilirubin**.

HYPERBILIRUBINEMIA CAUSES JAUNDICE

Hyperbilirubinemia, a blood level that exceeds 1 mg of bilirubin per dL (17 $\mu\text{mol/L}$), may result from **production** of more bilirubin than the normal liver can excrete, or from the failure of a damaged liver to **excrete** normal amounts of bilirubin. In the absence of hepatic damage, **obstruction** of the excretory ducts of the liver prevents the excretion of bilirubin, and will also cause hyperbilirubinemia. In all these situations, when the blood concentration of bilirubin reaches 2 to 2.5 mg/dL, it diffuses into the tissues, which turn yellow, a condition termed **jaundice** or **icterus**.

Occurrence of Unconjugated Bilirubin in Blood

Forms of hyperbilirubinemia include **retention hyperbilirubinemia** due to overproduction of bilirubin, and **regurgitation hyperbilirubinemia** due to reflux into the bloodstream because of biliary obstruction.

Because of its **hydrophobicity**, only *unconjugated* bilirubin can cross

the blood–brain barrier into the central nervous system. Encephalopathy due to hyperbilirubinemia (**kernicterus**) thus occurs only with unconjugated bilirubin, as in retention hyperbilirubinemia. Alternatively, because of its water solubility, only *conjugated* bilirubin can appear in urine. Accordingly, **choluric jaundice** (choluria is the presence of bile pigments in the urine) occurs only in regurgitation hyperbilirubinemia, and **acholuric jaundice** occurs only in the presence of an excess of unconjugated bilirubin. **Table 31–3** lists some causes of unconjugated and conjugated hyperbilirubinemia. A moderate hyperbilirubinemia accompanies **hemolytic anemias**. Hyperbilirubinemia is usually modest (< 4 mg bilirubin per dL; < 68 μmol/L) despite extensive hemolysis, due to the high capacity of a healthy liver to metabolize bilirubin.

TABLE 31–3 Some Causes of Unconjugated and Conjugated Hyperbilirubinemia

Unconjugated	Conjugated
Hemolytic anemias	Obstruction of the biliary tree
Neonatal “physiological jaundice”	Dubin–Johnson syndrome
Crigler-Najjar syndromes types I and II	Rotor syndrome
Gilbert syndrome	Liver diseases such as the various types of hepatitis
Toxic hyperbilirubinemia	

These causes are discussed briefly in the text. Common causes of obstruction of the biliary tree are a stone in the common bile duct and cancer of the head of the pancreas. Various liver diseases (eg, the various types of hepatitis) are frequent causes of predominantly conjugated hyperbilirubinemia.

DISORDERS OF BILIRUBIN METABOLISM

Neonatal “Physiologic Jaundice”

The unconjugated hyperbilirubinemia of neonatal “physiologic jaundice” results from accelerated hemolysis and an immature hepatic system for the uptake, conjugation, and secretion of bilirubin. In this transient condition, bilirubin-glucuronosyltransferase activity, and probably also synthesis of UDP-glucuronate, are reduced. When the plasma concentration of

unconjugated bilirubin exceeds that which can be tightly bound by albumin (20–25 mg/dL), bilirubin can penetrate the blood–brain barrier. If left untreated, the resulting **hyperbilirubinemic toxic encephalopathy**, or **kernicterus**, can result in mental retardation. Exposure of jaundiced neonates to blue light (phototherapy) promotes hepatic excretion of unconjugated bilirubin by converting some to derivatives that are excreted in the bile, and phenobarbital, a promoter of bilirubin metabolism, may be administered.

Defects of Bilirubin UDP-Glucuronosyltransferase

Glucuronosyltransferases (EC 2.4.1.17), a family of enzymes with differing substrate specificities, increase the polarity of various drugs and drug metabolites, thereby facilitating their excretion. Mutations in the gene that encodes **bilirubin UDP-glucuronosyltransferase** can result in the encoded enzyme having reduced or absent activity. Syndromes whose clinical presentation reflects the severity of the impairment include Gilbert syndrome and two types of Crigler-Najjar syndrome.

Gilbert Syndrome

Providing that about 30% of the bilirubin UDP-glucuronosyltransferase activity is retained in Gilbert syndrome, the condition is harmless.

Type I Crigler-Najjar Syndrome

The severe congenital jaundice (over 20 mg bilirubin per dL serum) and accompanying brain damage of type I Crigler-Najjar syndrome reflect the complete absence of hepatic UDP-glucuronosyltransferase activity. Phototherapy reduces plasma bilirubin levels somewhat, but phenobarbital has no beneficial effect. The disease is often fatal within the first 15 months of life.

Type II Crigler-Najjar Syndrome

In type II Crigler-Najjar syndrome, some bilirubin UDP-glucuronosyltransferase activity is retained. This condition thus is more benign than the type I syndrome. Serum bilirubin tends not to exceed 20 mg/dL of serum, and patients respond to treatment with large doses of phenobarbital.

Toxic Hyperbilirubinemia

Unconjugated hyperbilirubinemia can result from **toxin-induced liver**

dysfunction caused by, for example, chloroform, arsphenamines, carbon tetrachloride, acetaminophen, hepatitis virus, cirrhosis, or *Amanita* mushroom poisoning. These acquired disorders involve hepatic parenchymal cell damage, which impairs bilirubin conjugation.

Obstruction in the Biliary Tree Is the Most Common Cause of Conjugated Hyperbilirubinemia

Conjugated hyperbilirubinemia commonly results from blockage of the hepatic or common bile ducts, most often due to a **gallstone** or to **cancer of the head of the pancreas** (Figure 31–14). Bilirubin diglucuronide that cannot be excreted regurgitates into the hepatic veins and lymphatics, conjugated bilirubin appears in the blood and urine (**choluric jaundice**), and the stools typically are a pale color.

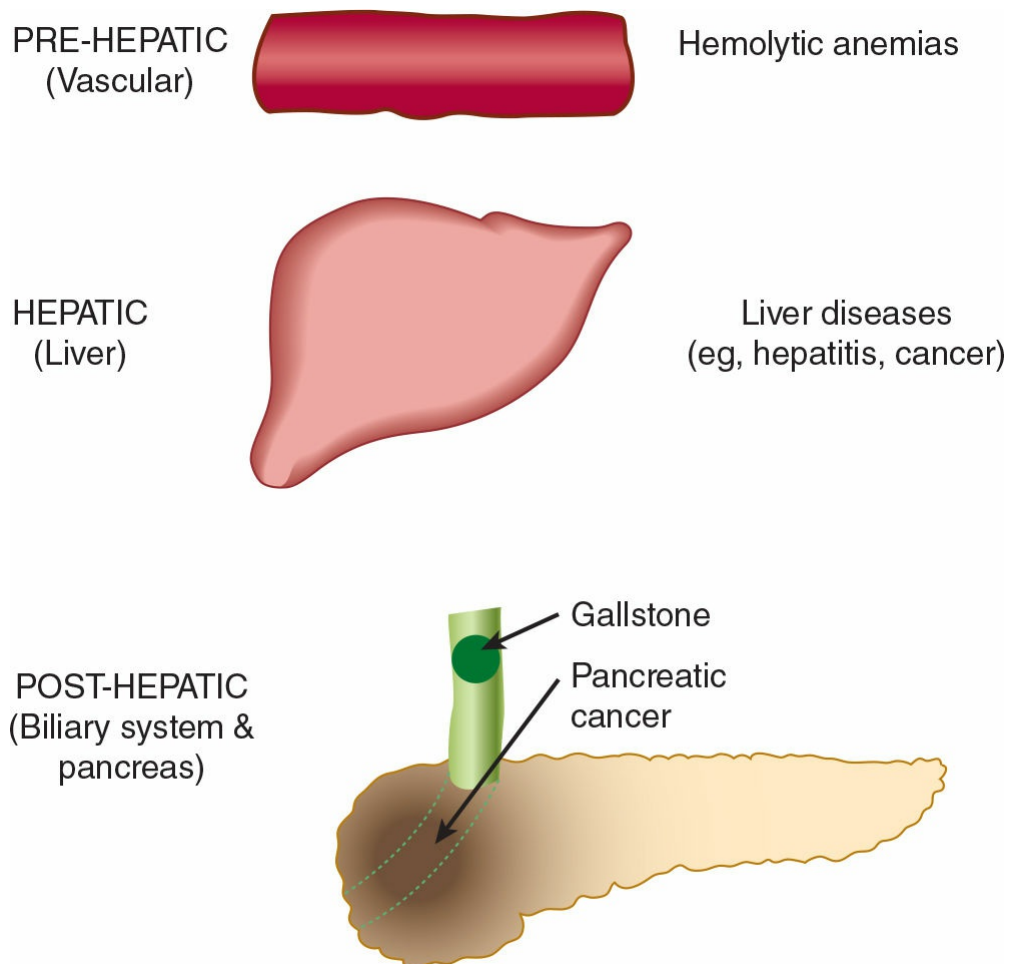

FIGURE 31–14 Major causes of jaundice. Prehepatic jaundice indicates events in the bloodstream, major causes being various hemolytic anemias. **Hepatic jaundice** arises from hepatitis or other liver diseases

(eg, cancer). **Posthepatic jaundice** refers to events in the biliary tree, for which the major causes are obstruction of the common bile duct by a gallstone (biliary calculus) or by cancer of the head of the pancreas.

The term **cholestatic jaundice** includes both all cases of extrahepatic obstructive jaundice and also conjugated hyperbilirubinemia due to micro-obstruction of intrahepatic biliary ductules by damaged hepatocytes, such as may occur in infectious hepatitis.

Dubin-Johnson Syndrome

This benign autosomal recessive disorder consists of **conjugated hyperbilirubinemia** in childhood or during adult life. The hyperbilirubinemia is caused by mutations in the gene encoding the protein involved in the **secretion** of conjugated bilirubin into bile.

Some Conjugated Bilirubin Can Bind Covalently to Albumin

When levels of conjugated bilirubin remain high in plasma, a fraction can bind covalently to albumin. This fraction, termed **δ -bilirubin**, has a **longer half-life** in plasma than does conventional conjugated bilirubin, and remains elevated during recovery from obstructive jaundice. Some patients therefore continue to appear jaundiced even after the circulating conjugated bilirubin level has returned to normal.

Urinary Urobilinogen & Bilirubin Are Clinical Indicators

In **complete obstruction of the bile duct**, bilirubin has no access to the intestine for conversion to urobilinogen, so no urobilinogen is present in the urine. The presence of conjugated bilirubin in the urine without urobilinogen suggests intrahepatic or posthepatic obstructive jaundice.

In **jaundice secondary to hemolysis**, the increased production of bilirubin leads to increased production of **urobilinogen**, which appears in the urine in large amounts. Bilirubin is not usually found in the urine in hemolytic jaundice, so the combination of increased urobilinogen and absence of bilirubin is suggestive of hemolytic jaundice. Increased blood destruction from any cause brings about an increase in urine urobilinogen.

Table 31–4 summarizes laboratory results obtained in patients with jaundice due to prehepatic, hepatic, or posthepatic causes: **hemolytic**

anemia (prehepatic), **hepatitis** (hepatic), and **obstruction of the common bile duct** (posthepatic); see [Figure 31–14](#). Laboratory tests on **blood** (evaluation of the possibility of a hemolytic anemia and measurement of prothrombin time) and on **serum** (eg, electrophoresis of proteins; alkaline phosphatase and alanine aminotransferase and aspartate aminotransferase activities) also help to distinguish between prehepatic, hepatic, and posthepatic causes of jaundice.

TABLE 31–4 Laboratory Results in Normal Patients and Patients With Three Different Causes of Jaundice

Condition	Serum Bilirubin	Urine Urobilinogen	Urine Bilirubin	Fecal Urobilinogen
Normal	Direct: 0.1-0.4 mg/dL Indirect: 0.2-0.7 mg/dL	0-4 mg/24 h	Absent	40-280 mg/24 h
Hemolytic anemia	↑Indirect	Increased	Absent	Increased
Hepatitis	↑Direct and indirect	Decreased if micro-obstruction is present	Present if micro-obstruction occurs	Decreased
Obstructive jaundice ^a	↑Direct	Absent	Present	Trace to absent

^aThe most common causes of obstructive (posthepatic) jaundice are cancer of the head of the pancreas and a gallstone lodged in the common bile duct. The presence of bilirubin in the urine is sometimes referred to as choloria—therefore, hepatitis and obstruction of the common bile duct cause choluric jaundice, whereas the jaundice of hemolytic anemia is referred to as acholuric. The laboratory results in patients with hepatitis are variable, depending on the extent of damage to parenchymal cells and the extent of micro-obstruction to bile ductules. Serum levels of **alanine aminotransferase** and **aspartate aminotransferase** are usually markedly elevated in hepatitis, whereas serum levels of **alkaline phosphatase** are elevated in obstructive liver disease.

SUMMARY

- The heme of hemoproteins such as hemoglobin and the cytochromes is an iron-containing porphyrin consisting of four pyrrole rings joined by methyne bridges.
- The eight methyl, vinyl, and propionyl substituents on the four pyrrole rings of heme are arranged in a specific sequence. The metal ion (Fe^{2+} in hemoglobin; Mg^{2+} in chlorophyll) is linked to the four nitrogen atoms of the pyrrole rings.
- Biosynthesis of the heme ring involves eight enzyme-catalyzed reactions, some of which occur in mitochondria, others in the cytosol.
- Synthesis of heme commences with the condensation of succinyl-CoA and glycine to form ALA. This reaction is catalyzed by ALAS1, the regulatory enzyme of heme biosynthesis.
- Synthesis of ALAS1 increases in response to a low level of available

heme. For example, certain drugs (eg, phenobarbital) indirectly trigger enhanced synthesis of ALAS1 by promoting synthesis of the heme protein cytochrome P450, which thereby depletes the heme pool. By contrast, ALAS2 is not regulated by heme levels, and consequently not by drugs that promote synthesis of cytochrome P450.

- Genetic abnormalities of seven of the eight enzymes of heme biosynthesis result in inherited porphyrias. Erythrocytes and liver are the major sites of expression of the porphyrias. Photosensitivity and neurologic problems are common complaints. Intake of certain toxins (eg, lead) can cause acquired porphyrias. Increased amounts of porphyrins or their precursors can be detected in blood and urine, facilitating diagnosis.
- Catabolism of the heme ring, initiated by the mitochondrial enzyme heme oxygenase, produces the linear tetrapyrrole, biliverdin. Subsequent reduction of biliverdin in the cytosol forms bilirubin.
- Bilirubin binds to albumin for transport from peripheral tissues to the liver, where it is taken up by hepatocytes. The iron of heme is released and reutilized.
- The water solubility of bilirubin is increased by the addition of two moles of the highly polar glucuronosyl moiety, derived from UDP-glucuronate, per mole of bilirubin. Attachment of the glucuronosyl moieties is catalyzed by bilirubin UDP-glucuronosyltransferase, one of a large family of enzymes with differing substrate specificity that increases the polarity of various drugs and their metabolites, thereby facilitating their excretion.
- Mutations in the encoding gene result in reduced or absent activity of bilirubin UDP-glucuronosyltransferase activity. Clinical presentations that reflect the severity of the mutation(s) include Gilbert syndrome and two types of Crigler-Najjar syndrome, conditions whose severity depend on the extent of remaining glucuronosyltransferase activity.
- Following secretion of bilirubin from the bile into the gut, bacterial enzymes convert bilirubin to urobilinogen and urobilin, which are excreted in the feces and urine.
- Colorimetric measurement of bilirubin employs the color formed when bilirubin reacts with diazotized sulfanilic acid. Assays conducted in the *absence* of added methanol measure “direct bilirubin” (ie, bilirubin glucuronide). Assays conducted in the *presence* of added methanol measure total bilirubin. The difference between total bilirubin and direct bilirubin, termed “indirect

bilirubin,” is unconjugated bilirubin.

- Jaundice results from an elevated level of plasma bilirubin. The causes of jaundice can be distinguished as prehepatic (eg, hemolytic anemias), hepatic (eg, hepatitis), or posthepatic (eg, obstruction of the common bile duct). Measurements of plasma total and nonconjugated bilirubin, of urinary urobilinogen and bilirubin, of the activity of certain serum enzymes, and the analysis of stool samples help distinguish between the causes of jaundice.

REFERENCES

Ajioka RS, Phillips JD, Kushner JP: Biosynthesis of heme in mammals. *Biochim Biophys Acta* 2006;1763:723.

Desnick RJ, Astrin KH: The porphyrias. In *Harrison's Principles of Internal Medicine*, 17th ed. Fauci AS (editor). McGraw-Hill, 2008.

Dufour DR: Liver disease. In *Tietz Textbook of Clinical Chemistry and Molecular Diagnostics*, 4th ed. Burtis CA, Ashwood ER, Bruns DE (editors). Elsevier Saunders, 2006.

Higgins T, Beutler E, Doumas BT: Hemoglobin, iron and bilirubin. In *Tietz Textbook of Clinical Chemistry and Molecular Diagnostics*, 4th ed. Burtis CA, Ashwood ER, Bruns DE (editors). Elsevier Saunders, 2006.

Pratt DS, Kaplan MM: Evaluation of liver function. In *Harrison's Principles of Internal Medicine*, 17th ed. Fauci AS (editor). McGraw-Hill, 2008.

Wolkoff AW: The hyperbilirubinemias. In *Harrison's Principles of Internal Medicine*, 17th ed. Fauci AS (editor). McGraw-Hill, 2008.

Exam Questions

Section VI - Metabolism of Proteins & Amino Acids

1. Select the one of the following statements that is NOT CORRECT:
 - A. Δ^1 -Pyrroline-5-carboxylate is an intermediate both in the

- biosynthesis and in the catabolism of L-proline.
- B. Human tissues can form dietarily nonessential amino acids from amphibolic intermediates or from dietarily essential amino acids.
 - C. Human liver tissue can form serine from the glycolytic intermediate 3-phosphoglycerate.
 - D. The reaction catalyzed by phenylalanine hydroxylase interconverts phenylalanine and tyrosine.
 - E. The reducing power of tetrahydrobiopterin derives ultimately from NADPH.
2. Identify the metabolite that does NOT serve as a precursor of a dietarily essential amino acid:
- A. α -Ketoglutarate
 - B. 3-Phosphoglycerate
 - C. Glutamate
 - D. Aspartate
 - E. Histamine
3. Select the one of the following statements that is NOT CORRECT:
- A. Selenocysteine is present at the active sites of certain human enzymes.
 - B. Selenocysteine is inserted into proteins by a posttranslational process.
 - C. Transamination of dietary α -keto acids can replace the dietary essential amino acids leucine, isoleucine, and valine.
 - D. Conversion of peptidyl proline to peptidyl-4-hydroxyproline is accompanied by the incorporation of oxygen into succinate.
 - E. Serine and glycine are interconverted in a single reaction in which tetrahydrofolate derivatives participate.
4. Select the CORRECT answer:
- The first reaction in the degradation of most of the protein amino acids involves the participation of:
- A. NAD^+
 - B. Thiamine pyrophosphate (TPP)
 - C. Pyridoxal phosphate
 - D. FAD

- E. NAD^+ and TPP
5. Identify the amino acid that is the major contributor to the transport of nitrogen destined for excretion as urea:
- A. Alanine
 - B. Glutamine
 - C. Glycine
 - D. Lysine
 - E. Ornithine
6. Select the one of the following statements that is NOT CORRECT:
- A. Angelman syndrome is associated with a defective ubiquitin E3 ligase.
 - B. Following a protein-rich meal, the splanchnic tissues release predominantly branched-chain amino acids, which are taken up by peripheral muscle tissue.
 - C. The rate of hepatic gluconeogenesis from glutamine exceeds that of any other amino acid.
 - D. The L- α -amino oxidase-catalyzed conversion of an α -amino acid to its corresponding α -keto acid is accompanied by the release of NH_4^+ .
 - E. Similar or even identical signs and symptoms can be associated with different mutations of the gene that encodes a given enzyme.
7. Select the one of the following statements that is NOT CORRECT:
- A. PEST sequences target some proteins for rapid degradation.
 - B. ATP and ubiquitin typically participate in the degradation of membrane-associated proteins and other proteins with long half-lives.
 - C. Ubiquitin molecules are attached to target proteins via non- α peptide bonds.
 - D. The discoverers of ubiquitin-mediated protein degradation received a Nobel Prize.
 - E. Degradation of ubiquitin-tagged proteins takes place in the proteasome, a multi-subunit macromolecule present in all eukaryotes.
8. For metabolic disorders of the urea cycle, which statement is NOT

CORRECT:

- A. Ammonia intoxication is most severe when the metabolic block in the urea cycle occurs prior to the reaction catalyzed by argininosuccinate synthase.
 - B. Clinical symptoms include mental retardation and the avoidance of protein-rich foods.
 - C. Clinical signs can include acidosis.
 - D. Aspartate provides the second nitrogen of argininosuccinate.
 - E. Dietary management focuses on a low-protein diet ingested as frequent small meals.
9. Select the one of the following statements that is NOT CORRECT:
- A. One metabolic function of glutamine is to sequester nitrogen in a nontoxic form.
 - B. Liver glutamate dehydrogenase is allosterically inhibited by ATP and activated by ADP.
 - C. Urea is formed both from absorbed ammonia produced by enteric bacteria and from ammonia generated by tissue metabolic activity.
 - D. The concerted action of glutamate dehydrogenase and glutamate aminotransferase may be termed transdeamination.
 - E. Fumarate generated during biosynthesis of argininosuccinate ultimately forms oxaloacetate in reactions in mitochondria catalyzed successively by fumarase and malate dehydrogenase.
10. Select the one of the following statements that is NOT CORRECT:
- A. Threonine provides the thioethanol moiety for biosynthesis of coenzyme A.
 - B. Histamine arises by decarboxylation of histidine.
 - C. Ornithine serves as a precursor of both spermine and spermidine.
 - D. Serotonin and melatonin are metabolites of tryptophan.
 - E. Glycine, arginine, and methionine each contribute atoms for biosynthesis of creatine.
11. Select the one of the following statements that is NOT CORRECT:
- A. Excreted creatinine is a function of muscle mass, and can be used to determine whether a patient has provided a complete 24-hour urine specimen.

- B. Many drugs and drug catabolites are excreted in urine as glycine conjugates.
 - C. The major nonprotein metabolic fate of methionine is conversion to S-adenosylmethionine.
 - D. The concentration of histamine in brain hypothalamus exhibits a circadian rhythm.
 - E. Decarboxylation of glutamine forms the inhibitory neurotransmitter GABA (γ -aminobutyrate).
12. What distinguishes the routes by which each of the following amino acids appears in human proteins?
- 5-Hydroxylysine
 - γ -Carboxyglutamate
 - Selenocysteine
13. What evolutionary advantage might be gained by the fact that certain amino acids are *dietarily* essential for human subjects?
14. What explanation can you offer to explain that metabolic defects that result in the complete absence of the activity of glutamate dehydrogenase have not been detected?
15. Which of the following is NOT a hemoprotein?
- A. Myoglobin
 - B. Cytochrome *c*
 - C. Catalase
 - D. Cytochrome P450
 - E. Albumin
16. A 30-year-old man presented at clinic with a history of intermittent abdominal pain and episodes of confusion and psychiatric problems. Laboratory tests revealed increases of urinary δ -aminolevulinate and porphobilinogen. Mutational analysis revealed a mutation in the gene for uroporphyrinogen I synthase (porphobilinogen deaminase). The probable diagnosis was:
- A. Acute intermittent porphyria.
 - B. X-linked sideroblastic anemia.
 - C. Congenital erythropoietic porphyria.

- D. Porphyrria cutanea tarda.
 - E. Variegate porphyria.
17. Select the one of the following statements that is NOT CORRECT:
- A. Bilirubin is a cyclic tetrapyrrole.
 - B. Albumin-bound bilirubin is transported to the liver.
 - C. High levels of bilirubin can cause damage to the brains of newborn infants.
 - D. Bilirubin contains methyl and vinyl groups.
 - B. Bilirubin does not contain iron.
18. A 62-year-old female presented at clinic with intense jaundice, steadily increasing over the preceding 3 months. She gave a history of severe upper abdominal pain, radiating to the back, and had lost considerable weight. She had noted that her stools had been very pale for some time. Lab tests revealed a very high level of direct bilirubin, and also elevated urinary bilirubin. The plasma level of alanine aminotransferase (ALT) was only slightly elevated, whereas the level of alkaline phosphatase was markedly elevated. Abdominal ultrasonography revealed no evidence of gallstones. Of the following, which is the most likely diagnosis?
- A. Gilbert syndrome
 - B. Hemolytic anemia
 - C. Type 1 Crigler-Najjar syndrome
 - D. Carcinoma of the pancreas
 - E. Infectious hepatitis
19. Clinical laboratories typically use diazotized sulfanilic acid to measure serum bilirubin and its derivatives. What is the physical basis that permits the laboratory to report results to the physician in terms of these two forms of bilirubin?
20. What signals the synthesis of heme to take place?

SECTION

VII

Structure, Function, & Replication of Informational Macromolecules

CHAPTER

32

Nucleotides

Victor W. Rodwell, PhD

OBJECTIVES

After studying this chapter, you should be able to:

- Write structural formulas to represent the amino- and oxo-tautomers of a purine and of a pyrimidine and state which tautomer predominates under physiologic conditions.
- Reproduce the structural formulas for the principal nucleotides present in DNA and in RNA and the less common nucleotides 5-methylcytosine, 5-hydroxymethylcytosine, and pseudouridine (ψ).

- Represent D-ribose or 2-deoxy-D-ribose linked as either a *syn* or an *anti* conformer to a purine, name the bond between the sugar and the base, and indicate which conformer predominates under most physiologic conditions.
- Number the C and N atoms of a pyrimidine ribonucleoside and of a purine deoxyribonucleoside, including using a primed numeral for C atoms of the sugars.
- Compare the phosphoryl group transfer potential of each phosphoryl group of a nucleoside triphosphate.
- Outline the physiologic roles of the cyclic phosphodiester cAMP and cGMP.
- Appreciate that polynucleotides are directional macromolecules composed of mononucleotides linked by 3' → 5'-phosphodiester bonds.
- Be familiar with the abbreviated representations of polynucleotide structures such as pTpGpT or TGCATCA, for which the 5'-end is always shown at the left and all phosphodiester bonds are 3' → 5'.
- For specific synthetic analogs of purine and pyrimidine bases and their derivatives that have served as anticancer drugs, indicate in what ways these compounds inhibit metabolism.

BIOMEDICAL IMPORTANCE

In addition to serving as precursors of nucleic acids, purine and pyrimidine nucleotides participate in metabolic functions as diverse as energy metabolism, protein synthesis, regulation of enzyme activity, and signal transduction. When linked to vitamins or vitamin derivatives, nucleotides form a portion of many coenzymes. As the principal donors and acceptors of phosphoryl groups in metabolism, nucleoside tri- and diphosphates such as ATP and ADP are the principal players in the energy transductions that accompany metabolic interconversions and oxidative phosphorylation. Linked to sugars or lipids, nucleosides constitute key biosynthetic intermediates. The sugar derivatives UDP-glucose and UDP-galactose participate in sugar interconversions and in the biosynthesis of starch and glycogen. Similarly, nucleoside-lipid derivatives such as CDP-acylglycerol are intermediates in lipid biosynthesis. Roles that nucleotides perform in metabolic regulation include ATP-dependent phosphorylation of key metabolic enzymes, allosteric regulation of enzymes by ATP, ADP, AMP, and CTP, and control by ADP of the rate of oxidative phosphorylation.

The cyclic nucleotides cAMP and cGMP serve as the second messengers in hormonally regulated events, and GTP and GDP play key roles in the cascade of events that characterize signal transduction pathways. In addition to the central roles that nucleotides play in metabolism, their medical applications include the use of synthetic purine and pyrimidine analogs that contain halogens, thiols, or additional nitrogen atoms in the chemotherapy of cancer and AIDS, and as suppressors of the immune response during organ transplantation.

CHEMISTRY OF PURINES, PYRIMIDINES, NUCLEOSIDES, & NUCLEOTIDES

Purines & Pyrimidines Are Heterocyclic Compounds

Purines and pyrimidines are nitrogen-containing **heterocycles**, cyclic structures that contain, in addition to carbon, other (hetero) atoms such as nitrogen. Note that the smaller pyrimidine molecule has the *longer* name and the larger purine molecule the *shorter* name, and that their six-atom rings are numbered in opposite directions (**Figure 32–1**). Purines or pyrimidines with an 'NH₂ group are weak bases (pK_a values 3-4), although the proton present at low pH is associated, not as one might expect with the exocyclic amino group, but with a ring nitrogen, typically N1 of adenine, N7 of guanine, and N3 of cytosine. The planar character of purines and pyrimidines facilitates their close association, or “stacking,” that stabilizes double-stranded DNA (see **Chapter 34**). The oxo and amino groups of purines and pyrimidines exhibit keto-enol and amine-imine **tautomerism** (**Figure 32–2**), although physiologic conditions strongly favor the amino and oxo forms.

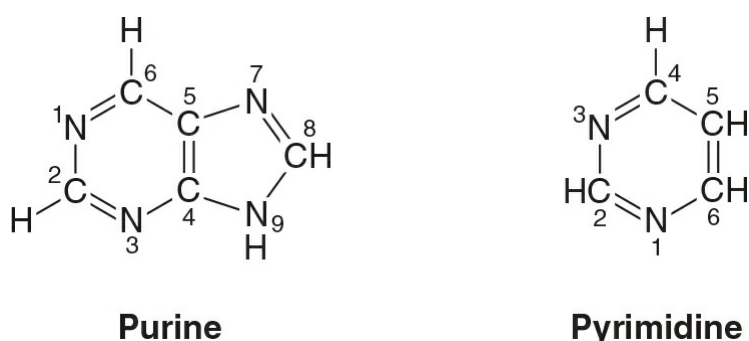

FIGURE 32–1 Purine and pyrimidine. The atoms are numbered according to the international system.



FIGURE 32–2 Tautomerism of the oxo and amino functional groups of purines and pyrimidines.

Nucleosides Are *N*-Glycosides

Nucleosides are derivatives of purines and pyrimidines that have a sugar linked to a ring nitrogen of a purine or pyrimidine. Numerals with a prime (eg, 2' or 3') distinguish atoms of the sugar from those of the heterocycle. The sugar in **ribonucleosides** is D-ribose, and in **deoxyribonucleosides** is 2-deoxy-D-ribose. Both sugars are linked to the heterocycle by an ***a-N*-glycosidic bond**, almost always to the *N*-1 of a pyrimidine or to *N*-9 of a purine (**Figure 32–3**).

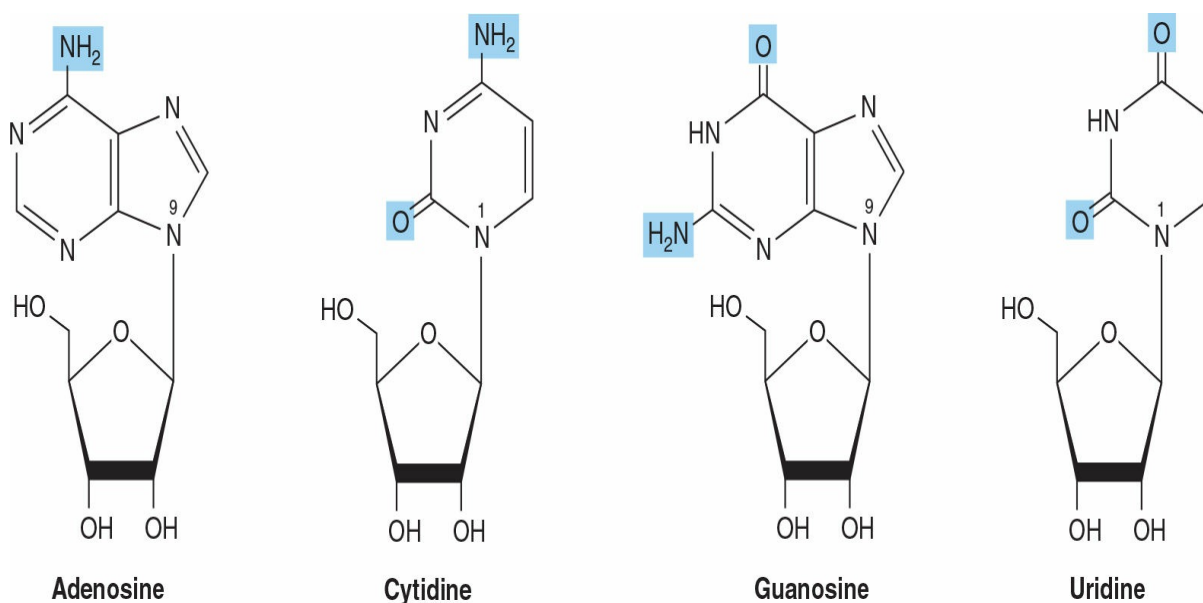

FIGURE 32–3 Ribonucleosides, drawn as the *syn* conformers.

Nucleotides Are Phosphorylated Nucleosides

Mononucleotides are nucleosides with a phosphoryl group esterified to a hydroxyl group of the sugar. The 3'- and 5'-nucleotides are nucleosides with a phosphoryl group on the 3'- or 5'-hydroxyl group of the sugar, respectively. Since most nucleotides are 5'-, the prefix “5'-” usually is omitted when naming them. UMP and dAMP thus represent nucleotides with a phosphoryl group on C-5 of the pentose. Additional phosphoryl

groups, ligated by **acid anhydride bonds** to the phosphoryl group of a mononucleotide, form **nucleoside diphosphates** and **triphosphates** (**Figure 32–4**).

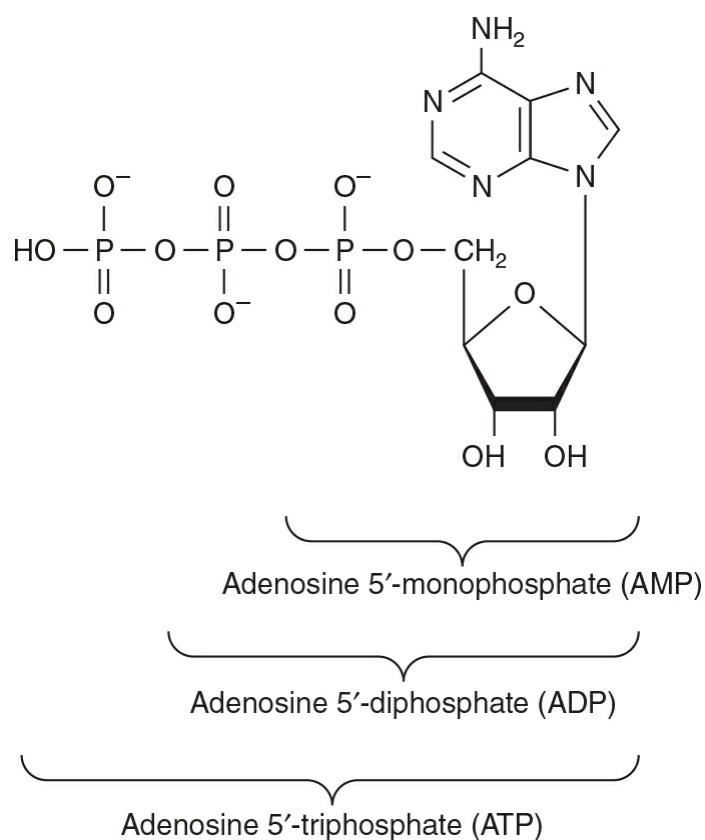

FIGURE 32–4 ATP, its diphosphate, and its monophosphate.

Heterocyclic *N*-Glycosides Exist as *Syn* and *Anti* Conformers

Steric hindrance by the heterocycle dictates that there is no freedom of rotation about the β -*N*-glycosidic bond of nucleosides or nucleotides. Both therefore exist as noninterconvertible **syn or anti conformers** (**Figure 32–5**). While both *syn* and *anti* conformers occur in nature, the *anti* conformers predominate.

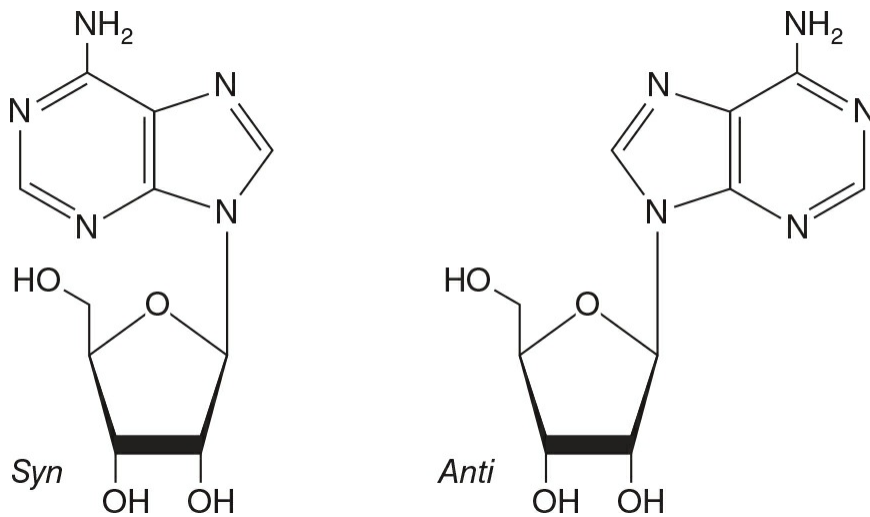
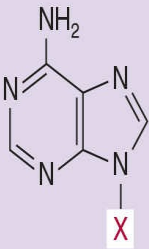
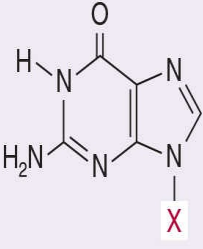
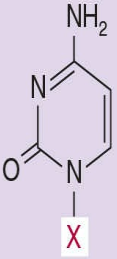
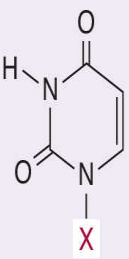
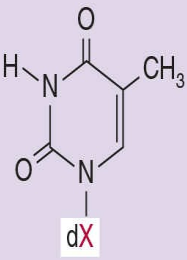

FIGURE 32–5 The *syn* and *anti* conformers of adenosine differ with respect to orientation about the *N*-glycosidic bond.

Table 32–1 lists the major purines and pyrimidines and their nucleoside and nucleotide derivatives. Single-letter abbreviations are used to identify adenine (A), guanine (G), cytosine (C), thymine (T), and uracil (U), whether free or present in nucleosides or nucleotides. The prefix “d” (deoxy) indicates that the sugar is 2'-deoxy-D-ribose (eg, in dATP) (**Figure 32–6**).

TABLE 32–1 Purine Bases, Ribonucleosides, and Ribonucleotides

Purine or Pyrimidine	X = H	X = Ribose	X = Ribose Phosphate
	Adenine	Adenosine	Adenosine monophosphate (AMP)
	Guanine	Guanosine	Guanosine monophosphate (GMP)
	Cytosine	Cytidine	Cytidine monophosphate (CMP)
	Uracil	Uridine	Uridine monophosphate (UMP)
	Thymine	Thymidine	Thymidine monophosphate (TMP)

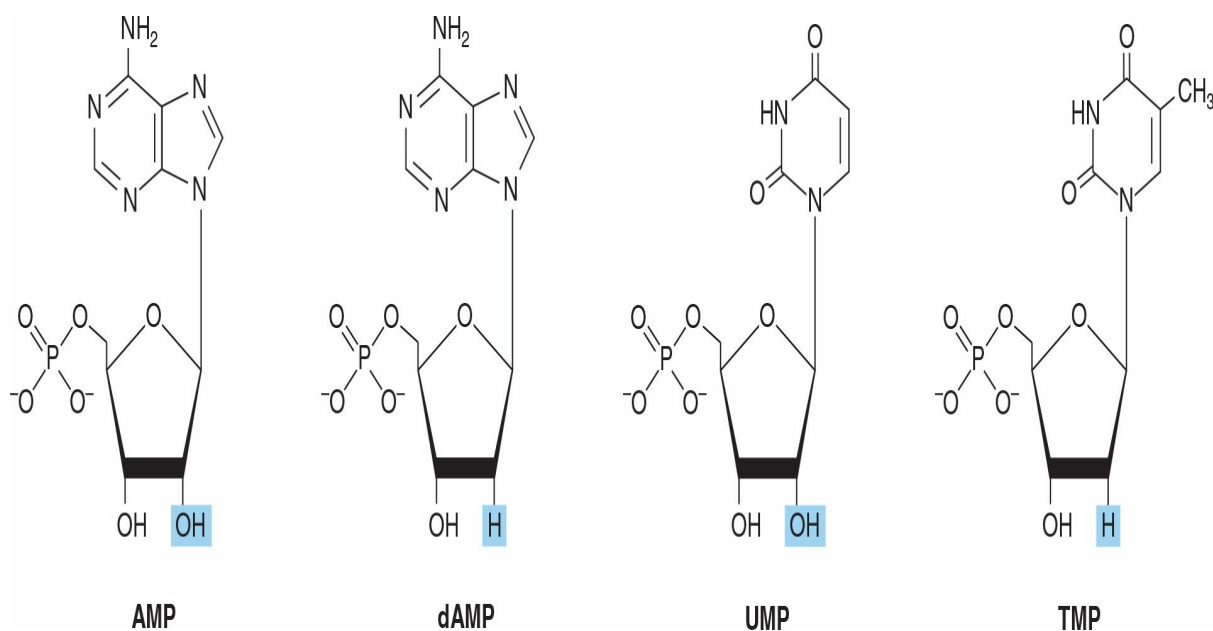
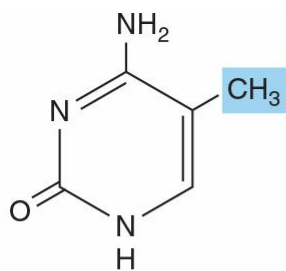

FIGURE 32–6 Structures of AMP, dAMP, UMP, and TMP.

Modification of Polynucleotides Can Generate Additional Structures

Small quantities of additional purines and pyrimidines occur in DNA and RNAs. Examples include 5-methylcytosine of bacterial and human DNA, 5-hydroxymethylcytosine of bacterial and viral nucleic acids, and mono- and the di-*N*-methylated adenine and guanine of mammalian messenger RNAs (**Figure 32–7**) that function in oligonucleotide recognition and in regulating the half-lives of RNAs. Free heterocyclic bases include hypoxanthine, xanthine, and uric acid (**Figure 32–8**), intermediates in the catabolism of adenine and guanine (see **Chapter 33**). Methylated heterocycles of plants include the xanthine derivatives caffeine of coffee, theophylline of tea, and theobromine of cocoa (**Figure 32–9**).



5-Methylcytosine

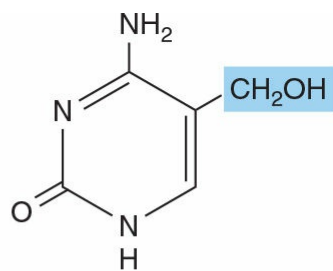

5-Hydroxymethylcytosine

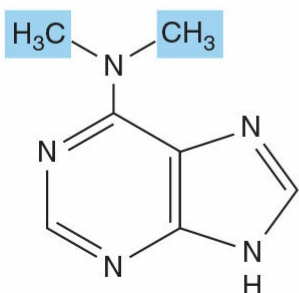

Dimethylaminoadenine

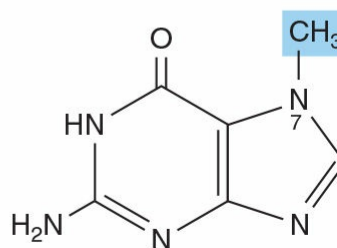

7-Methylguanine

FIGURE 32-7 Four uncommon naturally occurring pyrimidines and purines.

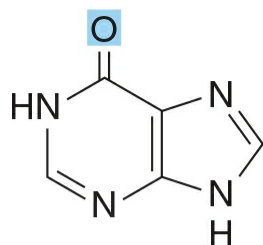

Hypoxanthine
(6-oxopurine)

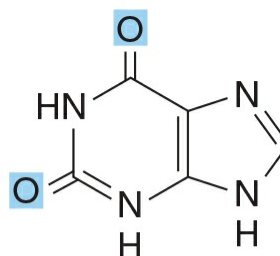

Xanthine
(2,6-dioxypurine)

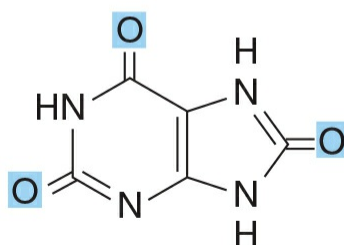

Uric acid
(2,6,8-trioxypurine)

FIGURE 32-8 Structures of hypoxanthine, xanthine, and uric acid, drawn as the oxo tautomers.

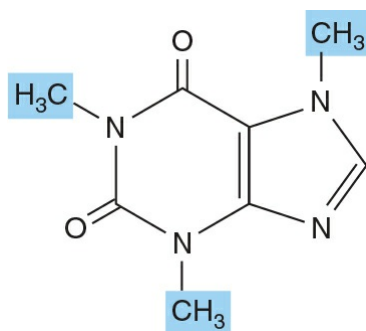

FIGURE 32–9 Caffeine, a trimethylxanthine. The dimethyl-xanthines theobromine and theophylline are similar but lack the methyl group at *N*-1 and at *N*-7, respectively.

Nucleotides Are Polyfunctional Acids

The primary and secondary phosphoryl groups of nucleosides have pK_a values of about 1.0 and 6.2, respectively. Nucleotides therefore bear significant negative charge at physiologic pH. The pK_a values of the secondary phosphoryl groups are such that they can serve either as proton donors or as proton acceptors at pH values approximately two or more units above or below neutrality.

Nucleotides Absorb Ultraviolet Light

The conjugated double bonds of purine and pyrimidine derivatives absorb ultraviolet light. While their spectra are pH-dependent, at pH 7.0 all the common nucleotides absorb light at a wavelength close to 260 nm. The concentration of nucleotides and nucleic acids thus often is expressed in terms of “absorbance at 260 nm.” The mutagenic effect of ultraviolet light is due to its absorption by nucleotides in DNA that results in chemical modifications (see [Chapter 35](#)).

Nucleotides Serve Diverse Physiologic Functions

In addition to their roles as precursors of nucleic acids, ATP, GTP, UTP, CTP, and their derivatives each serve unique physiologic functions discussed in other chapters. Selected examples include the role of ATP as the principal biologic transducer of free energy, and the second messenger cAMP ([Figure 32–10](#)). The mean intracellular concentration of ATP, the most abundant free nucleotide in mammalian cells, is about 1 mmol/L. Since little cAMP is required, the intracellular cAMP concentration (about

1 nmol/L) is six orders of magnitude below that of ATP. Other examples include adenosine 3'-phosphate-5'-phosphosulfate (**Figure 32-11**), the sulfate donor for sulfated proteoglycans (see **Chapter 50**) and for sulfate conjugates of drugs; and the methyl group donor S-adenosylmethionine (**Figure 32-12**). GTP serves as an allosteric regulator and as an energy source for protein synthesis, and cGMP (**Figure 32-10**) serves as a second messenger in response to nitric oxide (NO) during relaxation of smooth muscle (see **Chapter 51**).

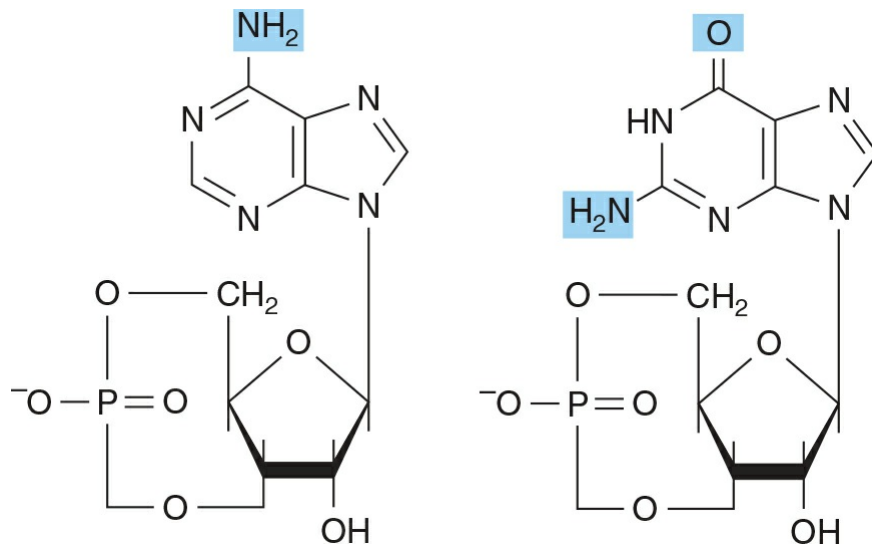

FIGURE 32-10 cAMP, 3',5'-cyclic AMP, and cGMP, 3', 5'-cyclic GMP.

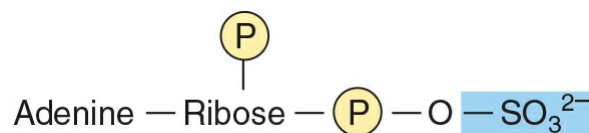

FIGURE 32-11 Adenosine 3'-phosphate-5'-phosphosulfate.

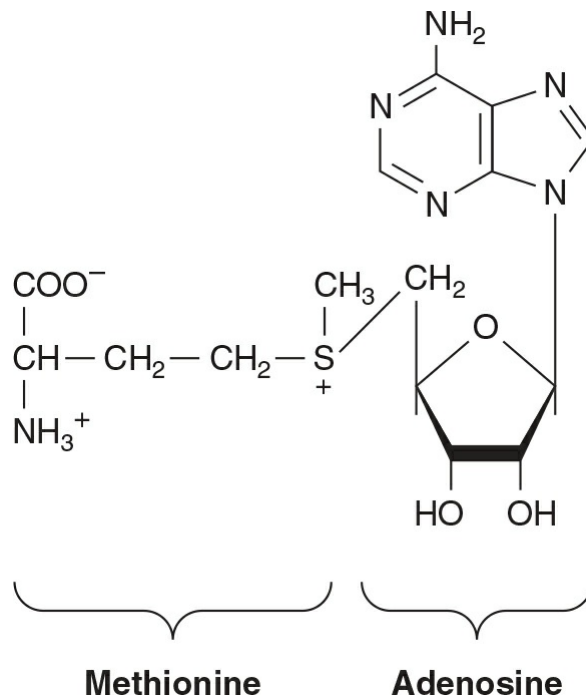
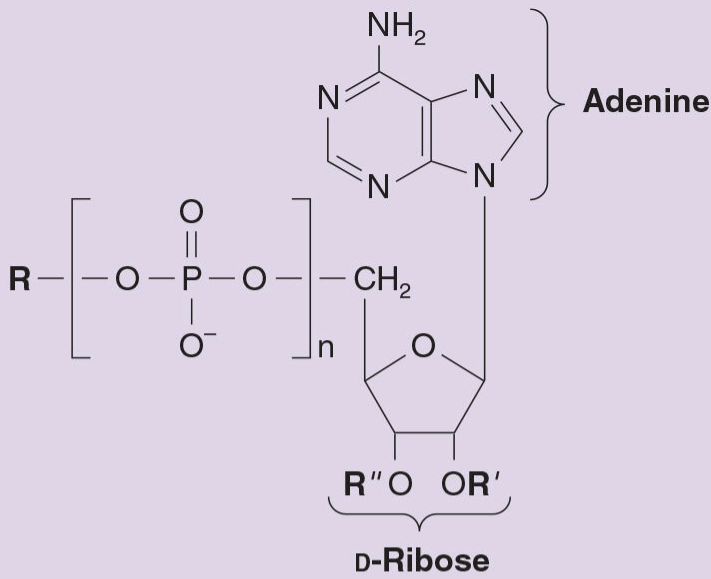

FIGURE 32–12 S-Adenosylmethionine.

UDP-sugar derivatives participate in sugar epimerizations and in biosynthesis of glycogen (see [Chapter 18](#)), glucosyl disaccharides, and the oligosaccharides of glycoproteins and proteoglycans (see [Chapters 46 & 50](#)). UDP-glucuronic acid forms the urinary glucuronide conjugates of bilirubin (see [Chapter 31](#)) and of many drugs, including aspirin. CTP participates in biosynthesis of phosphoglycerides, sphingomyelin, and other substituted sphingosines (see [Chapter 24](#)). Finally, many coenzymes incorporate nucleotides as well as structures similar to purine and pyrimidine nucleotides ([Table 32–2](#)).

TABLE 32–2 Many Coenzymes and Related Compounds Are Derivatives of Adenosine Monophosphate



The diagram illustrates the general structure of a nucleotide. It consists of an R group (where R is a vitamin B derivative) linked to a phosphate group (represented as $\text{O}=\text{P}(\text{O}^-)_2$). This phosphate group is further linked to a ribose sugar (D-Ribose) via a CH_2 group. The ribose sugar is shown in its cyclic form with substituents $\text{R}''\text{O}$ and OR' at the 3' and 5' positions, respectively. The adenine base is attached to the 1' position of the ribose sugar.

Coenzyme	R	R'	R''	n
Active methionine	Methionine ^a	H	H	0
Amino acid adenylates	Amino acid	H	H	1
Active sulfate	SO_3^{2-}	H	PO_3^{2-}	1
3',5'-Cyclic AMP		H	PO_3^{2-}	1
NAD ^b	Nicotinamide	H	H	2
NADP ^b	Nicotinamide	PO_3^{2-}	H	2
FAD	Riboflavin	H	H	2
Coenzyme A	Pantothenate	H	PO_3^{2-}	2

^aReplaces phosphoryl group.

^bR is a vitamin B derivative.

Nucleoside Triphosphates Have High Group Transfer Potential

Nucleotide triphosphates have two acid anhydride bonds and one ester bond. Unlike esters, acid anhydrides have a high-group transfer potential. ΔG^0 for the hydrolysis of each of the two terminal (β and γ) phosphoryl groups of a nucleoside triphosphate is about -7 kcal/mol (-30 kJ/mol). This high group transfer potential not only permits purine and pyrimidine

nucleoside triphosphates to function as group transfer reagents, most commonly of the γ -phosphoryl group, but also on occasion transfer of a nucleotide monophosphate moiety with an accompanying release of PP_i . Cleavage of an acid anhydride bond typically is coupled with a highly endergonic process such as covalent bond synthesis, for example, the polymerization of nucleoside triphosphates to form a nucleic acid (see [Chapter 34](#)).

SYNTHETIC NUCLEOTIDE ANALOGS ARE USED IN CHEMOTHERAPY

Synthetic analogs of purines, pyrimidines, nucleosides, and nucleotides modified in the heterocyclic ring or in the sugar moiety have numerous applications in clinical medicine. Their toxic effects reflect either inhibition of enzymes essential for nucleic acid synthesis or their incorporation into nucleic acids with resulting disruption of base pairing. Oncologists employ 5-fluoro- or 5-iodouracil, 3-deoxyuridine, 6-thioguanine and 6-mercaptopurine, 5- or 6-azauridine, 5- or 6-azacytidine, and 8-azaguanine ([Figure 32–13](#)), which are incorporated into DNA prior to cell division. The purine analog allopurinol, used in treatment of hyperuricemia and gout, inhibits purine biosynthesis and xanthine oxidase activity. Cytarabine is used in chemotherapy of cancer, and azathioprine, which is catabolized to 6-mercaptopurine, is employed during organ transplantation to suppress immunologic rejection ([Figure 32–14](#)).

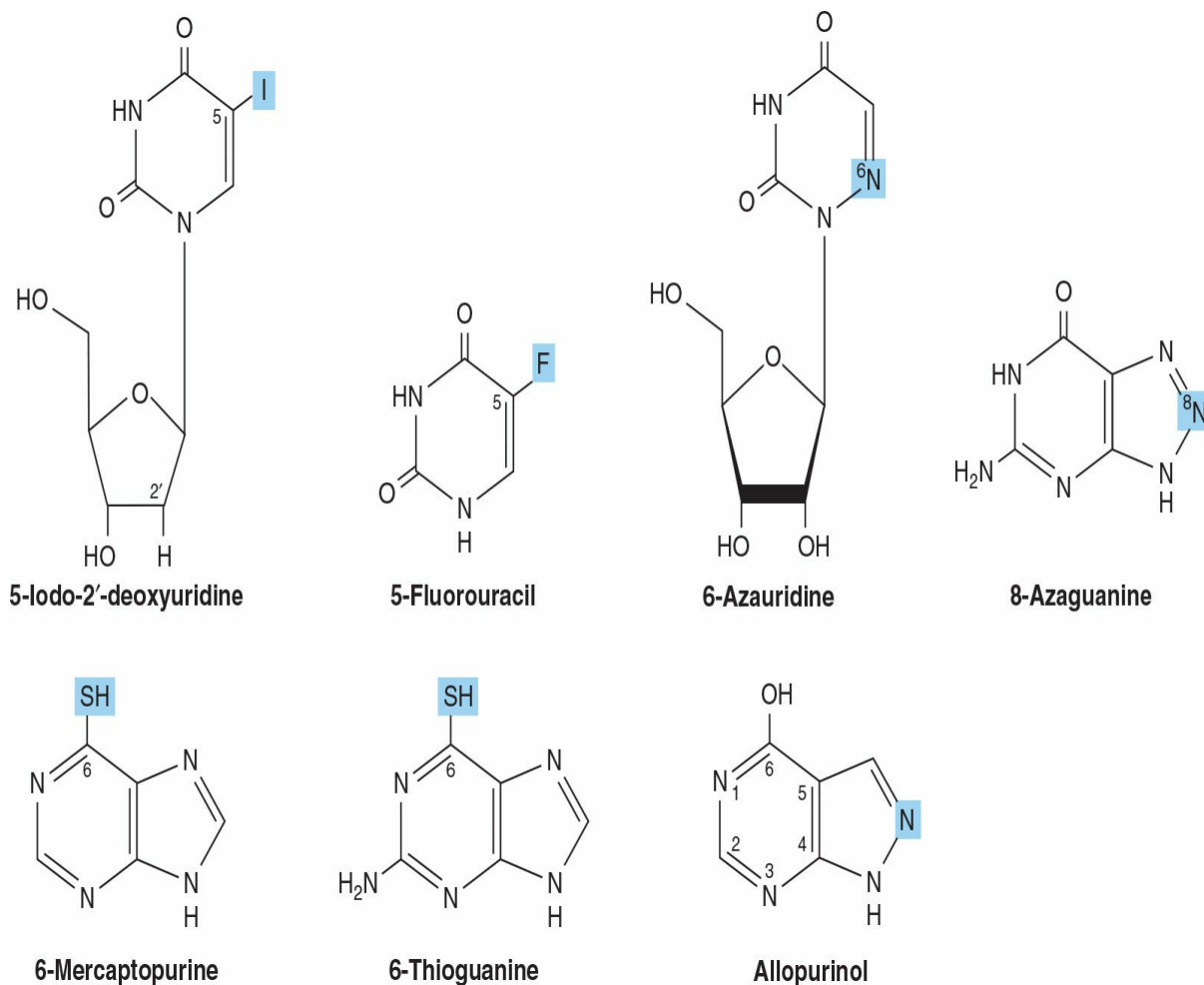

FIGURE 32–13 Selected synthetic pyrimidine and purine analogs.

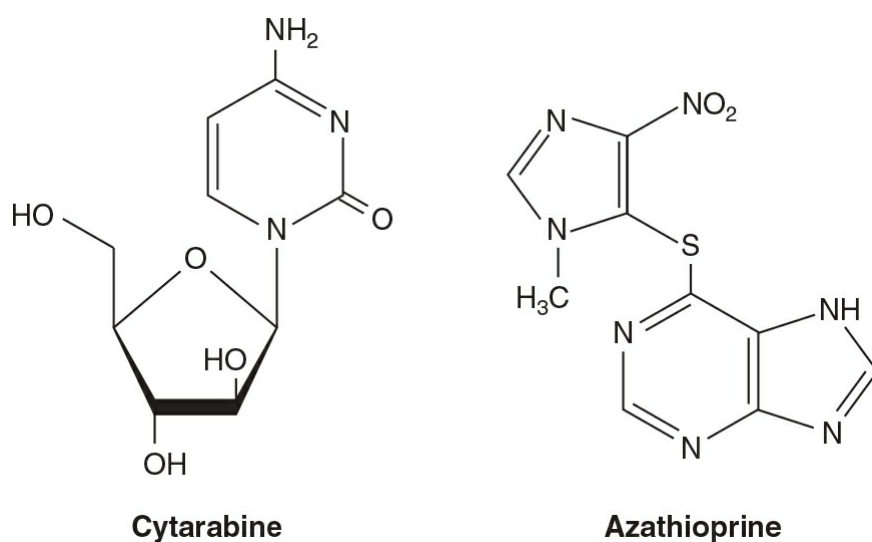

FIGURE 32–14 Cytarabine and azathioprine.

Non-Hydrolyzable Nucleoside Triphosphate Analogs

Serve as Research Tools

Synthetic, non-hydrolyzable analogs of nucleoside triphosphates (**Figure 32–15**) allow investigators to distinguish the effects of nucleotides due to phosphoryl transfer from effects mediated by occupancy of allosteric nucleotide-binding sites on regulated enzymes (see **Chapter 9**).

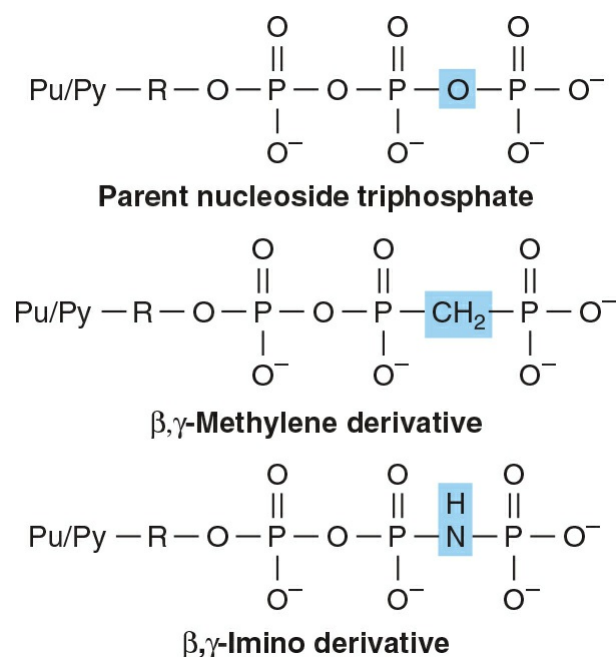

FIGURE 32–15 Synthetic derivatives of nucleoside triphosphates incapable of undergoing hydrolytic release of the terminal phosphoryl group. (Pu/Py, a purine or pyrimidine base; R, ribose or deoxyribose.) Shown are the parent (hydrolyzable) nucleoside triphosphate (**top**) and the unhydrolyzable β -methylene (**center**) and γ -imino derivatives (**bottom**).

DNA & RNA ARE POLYNUCLEOTIDES

The 5'-phosphoryl group of a mononucleotide can esterify a second hydroxyl group, forming a **phosphodiester**. Most commonly, this second hydroxyl group is the 3'-OH of the pentose of a second nucleotide. This forms a **dinucleotide** in which the pentose moieties are linked by a 3',5'-phosphodiester bond to form the “backbone” of RNA and DNA. The formation of a dinucleotide may be represented as the elimination of water between two mononucleotides. Biologic formation of dinucleotides does not, however, occur in this way because the reverse reaction, hydrolysis of the phosphodiester bond, is strongly favored on thermodynamic grounds. However, despite an extremely favorable ΔG , in the absence of catalysis by **phosphodiesterases** hydrolysis of the phosphodiester bonds of DNA

occurs only over long periods of time. DNA therefore persists for considerable periods, and has been detected even in fossils. RNAs are far less stable than DNA since the 2'-hydroxyl group of RNA (absent from DNA) functions as a nucleophile during hydrolysis of the 3',5'-phosphodiester bond.

Posttranslational modification of preformed **polynucleotides** can generate additional structures such as **pseudouridine**, a nucleoside in which D-ribose is linked to C-5 of uracil by a **carbon-to-carbon bond** rather than by the usual β -N-glycosidic bond. The nucleotide pseudouridylic acid (ψ) arises by rearrangement of a UMP of a preformed tRNA. Similarly, methylation by S-adenosylmethionine of a UMP of preformed tRNA forms TMP (thymidine monophosphate), which contains ribose rather than deoxyribose.

Polynucleotides Are Directional Macromolecules

Directional 3' \rightarrow 5' phosphodiester bonds link the monomers of polynucleotides. Since each end of a polynucleotide thus is distinct, we refer to the "5'-end" or the "3'-end" of a polynucleotide. Since the phosphodiester bonds all are 3' \rightarrow 5', the representation pGpGpApTpCpA indicates that only the 5'-hydroxyl is phosphorylated. More concisely, the representation GGATC, which shows only the base sequence, is by convention written with the 5'-base (G) at the *left* and the 3'-base (C) at the *right*.

SUMMARY

- Under physiologic conditions, the amino and oxo tautomers of purines, pyrimidines, and their derivatives predominate.
- Nucleic acids contain, in addition to A, G, C, T, and U, traces of 5-methylcytosine, 5-hydroxymethylcytosine, pseudouridine (ψ), and N-methylated heterocycles.
- Most nucleosides contain D-ribose or 2-deoxy-D-ribose linked to N-1 of a pyrimidine or to N-9 of a purine by a β -glycosidic bond whose *syn* conformers predominate.
- A primed numeral indicates the hydroxyl to which the phosphoryl group of the sugars of mononucleotides (eg, 3'-GMP, 5'-dCMP) is attached. Additional phosphoryl groups linked to the first by acid anhydride bonds form nucleoside diphosphates and triphosphates.
- Nucleoside triphosphates have high group transfer potential and

participate in covalent bond syntheses. The cyclic phosphodiester cAMP and cGMP function as intracellular second messengers.

- Mononucleotides linked by 3' → 5'-phosphodiester bonds form polynucleotides, directional macromolecules with distinct 3'- and 5'-ends. When represented as pTpGpT or TGCATCA, the 5'-end is at the left, and all phosphodiester bonds are 3' → 5'.
- Synthetic analogs of purine and pyrimidine bases and their derivatives serve as anticancer drugs either by inhibiting an enzyme of nucleotide biosynthesis or by being incorporated into DNA or RNA.

REFERENCES

- Adams RLP, Knowler JT, Leader DP: *The Biochemistry of the Nucleic Acids*, 11th ed. Chapman & Hall, 1992.
- Blackburn GM, Gait MJ, Loaks D, et al: *Nucleic Acids in Chemistry and Biology*, 3rd ed., RSC Publishing, 2006.
- Pacher P, Nivorozhkin A, Szabo C: Therapeutic effects of xanthine oxidase inhibitors: renaissance half a century after the discovery of allopurinol. *Pharmacol Rev* 2006;58:87.

Metabolism of Purine & Pyrimidine Nucleotides

Victor W. Rodwell, PhD

OBJECTIVES

After studying this chapter, you should be able to:

- Compare and contrast the roles of dietary nucleic acids and of de novo biosynthesis in the production of purines and pyrimidines destined for polynucleotide biosynthesis.
- Explain why antifolate drugs and analogs of the amino acid glutamine inhibit purine biosynthesis.
- Outline the sequence of reactions that convert inosine monophosphate (IMP), first to AMP and GMP, and subsequently to their corresponding nucleoside triphosphates.
- Describe the formation from ribonucleotides of deoxyribonucleotides (dNTPs).
- Indicate the regulatory role of phosphoribosyl pyrophosphate (PRPP) in hepatic purine biosynthesis and the specific reaction of hepatic purine biosynthesis that is feedback inhibited by AMP and GMP.
- State the relevance of coordinated control of purine and

pyrimidine nucleotide biosynthesis.

- Identify the reactions discussed that are inhibited by anticancer drugs.
- Write the structure of the end product of purine catabolism. Comment on its solubility and indicate its role in gout, Lesch-Nyhan syndrome, and von Gierke disease.
- Identify reactions whose impairment leads to modified pathologic signs and symptoms.
- Indicate why there are few clinically significant disorders of pyrimidine catabolism.

BIOMEDICAL IMPORTANCE

Despite a diet that may be rich in nucleoproteins, dietary purines and pyrimidines are not incorporated directly into tissue nucleic acids. Humans synthesize the nucleic acids and their derivatives ATP, NAD⁺, coenzyme A, etc, from amphibolic intermediates. However, *injected* purine or pyrimidine analogs, including potential anticancer drugs, may nevertheless be incorporated into DNA. The biosyntheses of purine and pyrimidine ribonucleotide triphosphates (NTPs) and dNTPs are precisely regulated events. Coordinated feedback mechanisms ensure their production in appropriate quantities and at times that match varying physiologic demand (eg, cell division). Human diseases that involve abnormalities in purine metabolism include gout, Lesch-Nyhan syndrome, adenosine deaminase deficiency, and purine nucleoside phosphorylase deficiency. Diseases of pyrimidine biosynthesis are rarer, but include orotic acidurias. Unlike the low solubility of uric acid formed by catabolism of purines, the end products of pyrimidine catabolism (carbon dioxide, ammonia, β -alanine, and γ -aminoisobutyrate) are highly water soluble. One genetic disorder of pyrimidine catabolism, β -hydroxybutyric aciduria, is due to total or partial deficiency of the enzyme dihydropyrimidine dehydrogenase. This disorder of pyrimidine catabolism, also known as combined uraciluria-thyminuria, is also a disorder of β -amino acid biosynthesis, since the formation of β -alanine and of β -aminoisobutyrate is impaired. A nongenetic form can be triggered by administration of 5-fluorouracil to patients with low levels of dihydropyrimidine dehydrogenase.

PURINES & PYRIMIDINES ARE DIETARILY

NONESSENTIAL

Normal human tissues can synthesize purines and pyrimidines from amphibolic intermediates in quantities and at times appropriate to meet variable physiologic demand. Ingested nucleic acids and nucleotides therefore are dietarily nonessential. Following their degradation in the intestinal tract, the resulting mononucleotides may be absorbed or converted to purine and pyrimidine bases. The purine bases are then oxidized to uric acid, which may be absorbed and excreted in the urine. While little or no dietary purine or pyrimidine is incorporated into tissue nucleic acids, *injected* compounds are incorporated. The incorporation of injected [^3H] thymidine into newly synthesized DNA thus can be used to measure the rate of DNA synthesis.

BIOSYNTHESIS OF PURINE NUCLEOTIDES

With the exception of parasitic protozoa, all forms of life synthesize purine and pyrimidine nucleotides. Synthesis from amphibolic intermediates proceeds at controlled rates appropriate for all cellular functions. To achieve homeostasis, intracellular mechanisms sense and regulate the pool sizes of NTPs, which rise during growth or tissue regeneration when cells are rapidly dividing.

Purine and pyrimidine nucleotides are synthesized *in vivo* at rates consistent with physiologic need. Early investigations of nucleotide biosynthesis first employed birds, and later *Escherichia coli*. Isotopic precursors of uric acid fed to pigeons established the source of each atom of a purine (**Figure 33–1**) and initiated study of the intermediates of purine biosynthesis. Avian tissues also served as a source of cloned genes that encode enzymes of purine biosynthesis and the regulatory proteins that control the rate of purine biosynthesis.

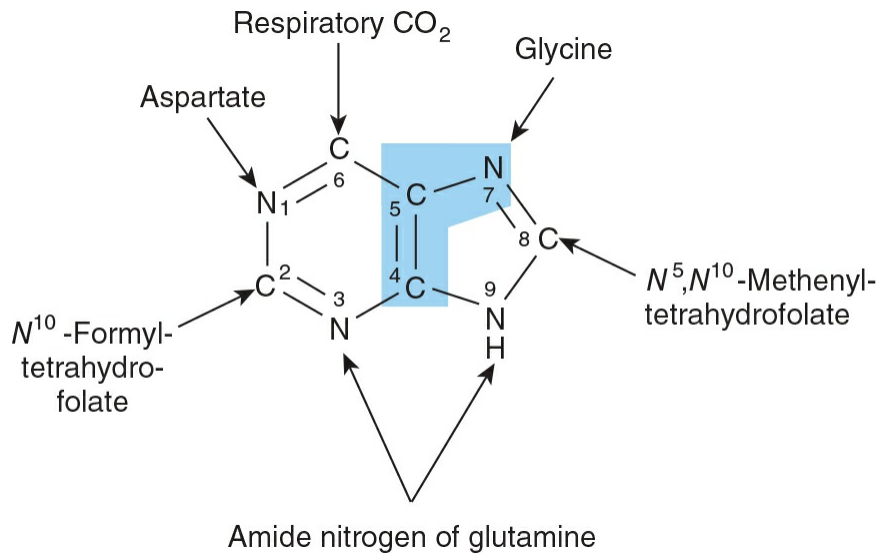

FIGURE 33–1 Sources of the nitrogen and carbon atoms of the purine ring. Atoms 4, 5, and 7 (blue highlight) derive from glycine.

The three processes that contribute to purine nucleotide biosynthesis are, in order of decreasing importance:

1. Synthesis from amphibolic intermediates (synthesis de novo)
2. Phosphoribosylation of purines
3. Phosphorylation of purine nucleosides

INOSINE MONOPHOSPHATE (IMP) IS SYNTHESIZED FROM AMPHIBOLIC INTERMEDIATES

The initial reaction of purine biosynthesis, transfer of two phosphoryl groups from ATP to carbon 1 of ribose 5-phosphate forming phosphoribosyl pyrophosphate (PRPP), is catalyzed by PRPP synthetase, EC 2.7.6.1. The end product of the ten subsequent enzyme-catalyzed reactions is IMP (**Figure 33–2**).

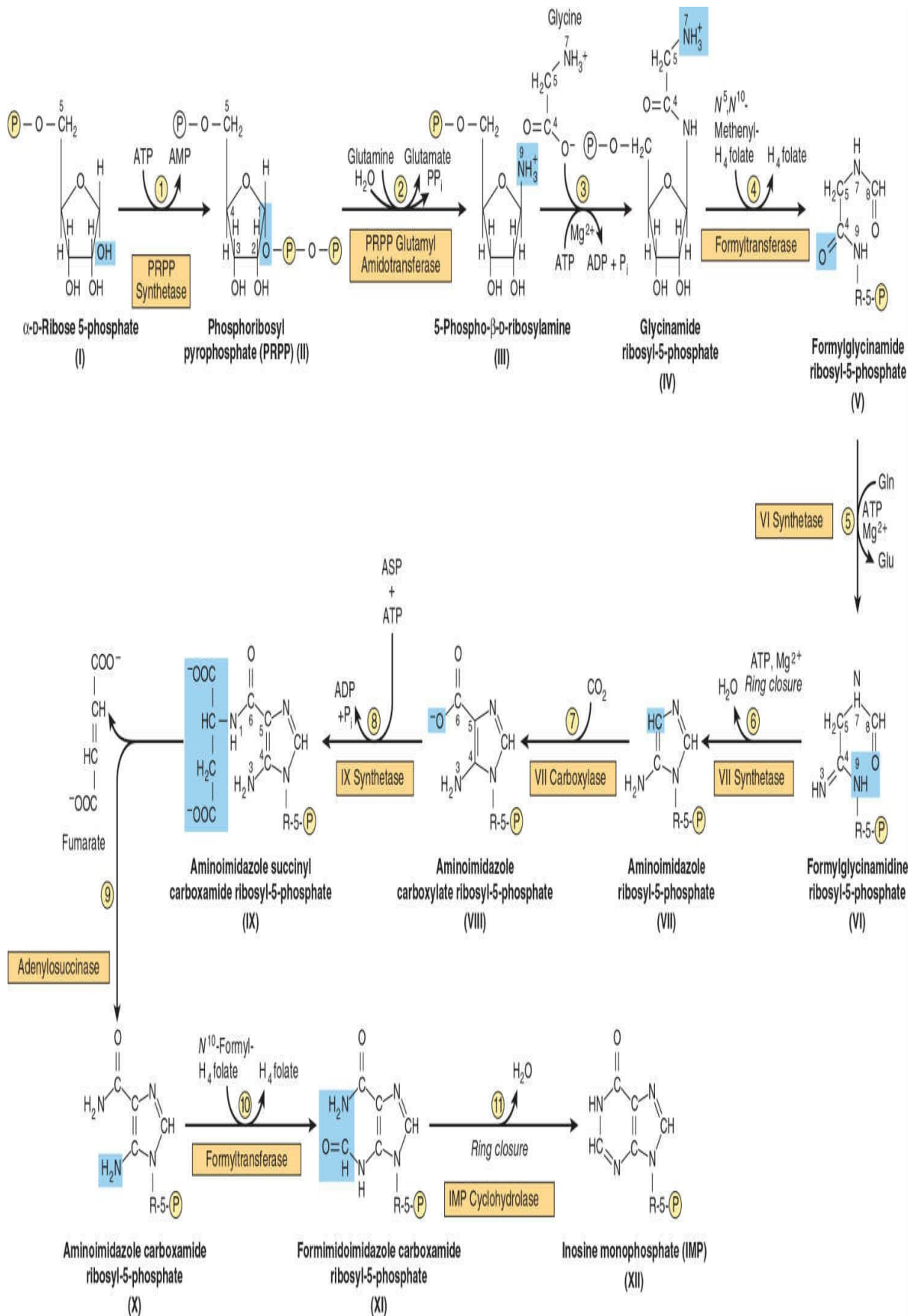

FIGURE 33–2 Purine biosynthesis from ribose 5-phosphate and ATP.

See the text for explanations. (P, PO₃²⁻ or PO₂⁻.)

Following synthesis of IMP, separate branches lead to AMP and GMP (**Figure 33–3**). Subsequent phosphoryl transfer from ATP converts AMP and GMP to ADP and GDP, respectively. Conversion of GDP to GTP involves a second phosphoryl transfer from ATP, whereas conversion of ADP to ATP is achieved primarily by oxidative phosphorylation (see **Chapter 13**).

Multifunctional Catalysts Participate in Purine Nucleotide Biosynthesis

In prokaryotes, each reaction of **Figure 33–2** is catalyzed by a different polypeptide. By contrast, the enzymes of eukaryotes are polypeptides that possess multiple catalytic activities whose adjacent catalytic sites facilitate channeling of intermediates between sites. Three distinct multifunctional enzymes catalyze reactions ③, ④, and ⑥; reactions ⑦ and ⑧; and reactions ⑩ and ⑪ of **Figure 33–2**.

Antifolate Drugs & Glutamine Analogs Block Purine Nucleotide Biosynthesis

The carbons added in reactions ④ and ⑩ of **Figure 33–2** are contributed by derivatives of tetrahydrofolate. Purine deficiency states, while rare in humans, generally reflect a deficiency of folic acid. Compounds that inhibit formation of tetrahydrofolates and therefore block purine synthesis have been used in cancer chemotherapy. Inhibitory compounds and the reactions they inhibit include **azaserine** (reaction ⑤, **Figure 33–2**), **diazanorleucine** (reaction ②, **Figure 33–2**), **6-mercaptopurine** (reactions ⑬ and ⑭, **Figure 33–3**), and **mycophenolic acid** (reaction ⑭, **Figure 33–3**).

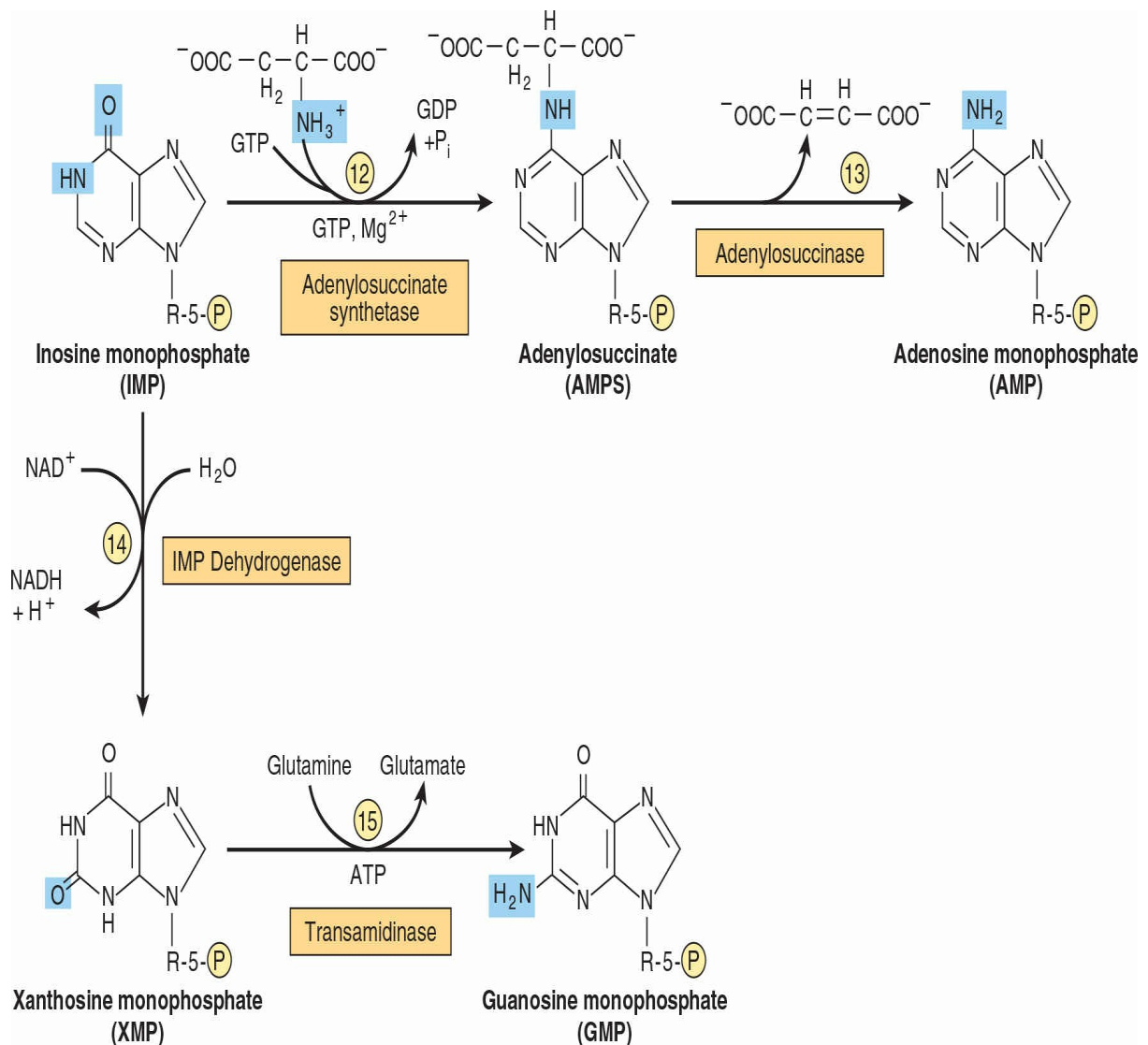
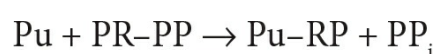

FIGURE 33–3 Conversion of IMP to AMP and GMP.

“SALVAGE REACTIONS” CONVERT PURINES & THEIR NUCLEOSIDES TO MONONUCLEOTIDES

Conversion of purines, their ribonucleosides, and their deoxyribonucleosides to mononucleotides involves “salvage reactions” that require far less energy than de novo synthesis. The more important mechanism involves phosphoribosylation by PRPP (structure II, [Figure 33–2](#)) of a free purine (Pu) to form a purine 5'-mononucleotide (Pu-RP).



Phosphoryl transfer from PRPP catalyzed by adenosine- and hypoxanthine-phosphoribosyl transferases (EC 2.4.2.7 & EC 2.4.2.8,

respectively), converts adenine, hypoxanthine, and guanine to their mononucleotides (**Figure 33–4**).

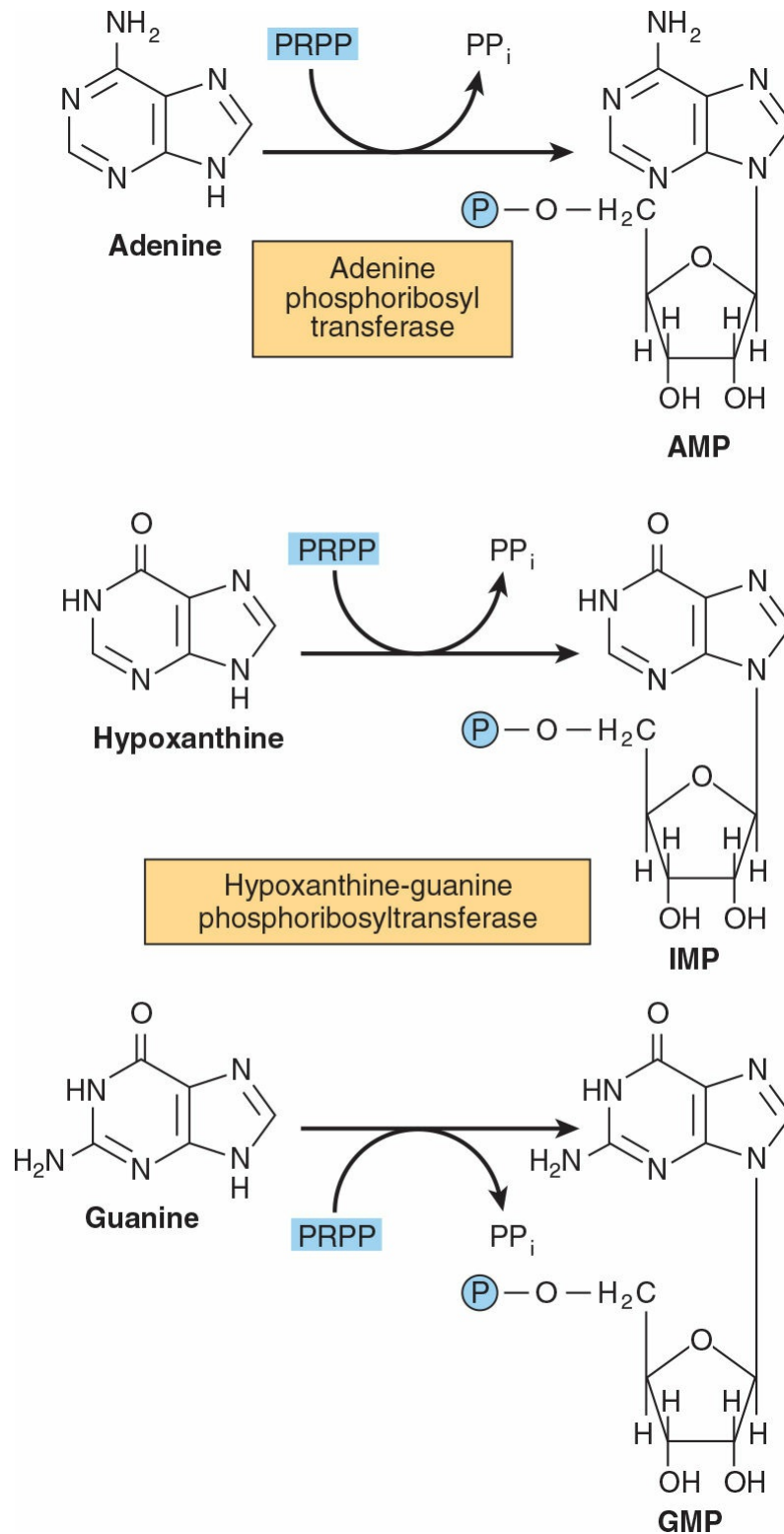
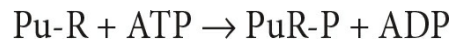

FIGURE 33–4 Phosphoribosylation of adenine, hypoxanthine, and guanine to form AMP, IMP, and GMP, respectively.

A second salvage mechanism involves phosphoryl transfer from ATP to a purine ribonucleoside (Pu-R):



Phosphorylation of the purine nucleotides, catalyzed by adenosine kinase (EC 2.7.1.20), converts adenosine and deoxyadenosine to AMP and dAMP. Similarly, deoxycytidine kinase (EC 2.7.1.24) phosphorylates deoxycytidine and 2'-deoxyguanosine, forming dCMP and dGMP, respectively.

Liver, the major site of purine nucleotide biosynthesis, provides purines and purine nucleosides for salvage and for utilization by tissues incapable of their biosynthesis. Human brain tissue has a low level of PRPP glutamyl amidotransferase, EC 2.4.2.14 (reaction ②, [Figure 33–2](#)) and hence depends in part on exogenous purines. Erythrocytes and polymorphonuclear leukocytes cannot synthesize 5-phosphoribosylamine (structure III, [Figure 33–2](#)), and therefore also utilize exogenous purines to form nucleotides.

HEPATIC PURINE BIOSYNTHESIS IS STRINGENTLY REGULATED

AMP & GMP Feedback Regulate PRPP Glutamyl Amidotransferase

Biosynthesis of IMP is energetically expensive. In addition to ATP, glycine, glutamine, aspartate, and reduced tetrahydrofolate derivatives all are consumed. Thus, it is of survival advantage to closely regulate purine biosynthesis in response to varying physiologic need. The overall determinant of the rate of de novo purine nucleotide biosynthesis is the concentration of PRPP. This, in turn, depends on the rate of PRPP synthesis, utilization, degradation, and regulation. The rate of PRPP synthesis depends on the availability of ribose 5-phosphate and on the activity of PRPP synthetase, EC 2.7.6.1 (reaction ② [Figure 33–5](#)), an enzyme whose activity is feedback inhibited by AMP, ADP, GMP, and GDP. Elevated levels of these nucleoside phosphates thus signal a physiologically appropriate overall decrease in their biosynthesis.

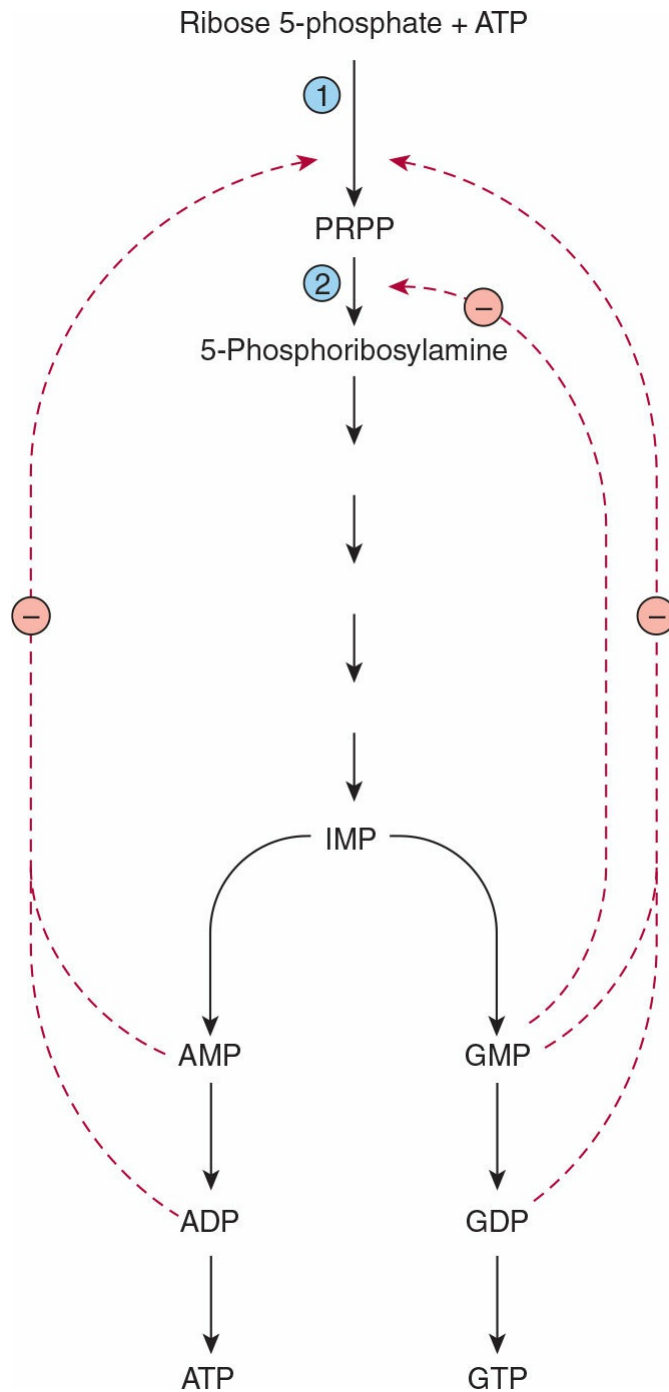

FIGURE 33–5 Control of the rate of de novo purine nucleotide biosynthesis. Reactions ① and ② are catalyzed by PRPP synthetase and by PRPP glutamyl amidotransferase, respectively. Solid lines represent chemical flow. Broken red lines represent feedback inhibition by intermediates of the pathway.

AMP & GMP Feedback Regulate Their Formation From IMP

In addition to regulation at the level of PRPP biosynthesis, additional mechanisms that regulate conversion of IMP to ATP and GTP are summarized in **Figure 33–6**. AMP feedback inhibits adenylosuccinate synthetase, EC 6.3.4.4 (reaction ⑫, **Figure 33–3**), and GMP inhibits IMP dehydrogenase, EC 1.1.1.205 (reaction ⑭, **Figure 33–3**). Furthermore, conversion of IMP to adenylosuccinate en route to AMP (reaction ⑫, **Figure 33–3**) requires GTP, and conversion of xanthylate (XMP) to GMP requires ATP. This cross-regulation between the pathways of IMP metabolism thus serves to balance the biosynthesis of purine nucleoside triphosphates by decreasing the synthesis of one purine nucleotide when there is a deficiency of the other nucleotide. AMP and GMP also inhibit hypoxanthine-guanine phosphoribosyltransferase, which converts hypoxanthine and guanine to IMP and GMP (**Figure 33–4**), and GMP feedback inhibits PRPP glutamyl amidotransferase (reaction ②, **Figure 33–2**).

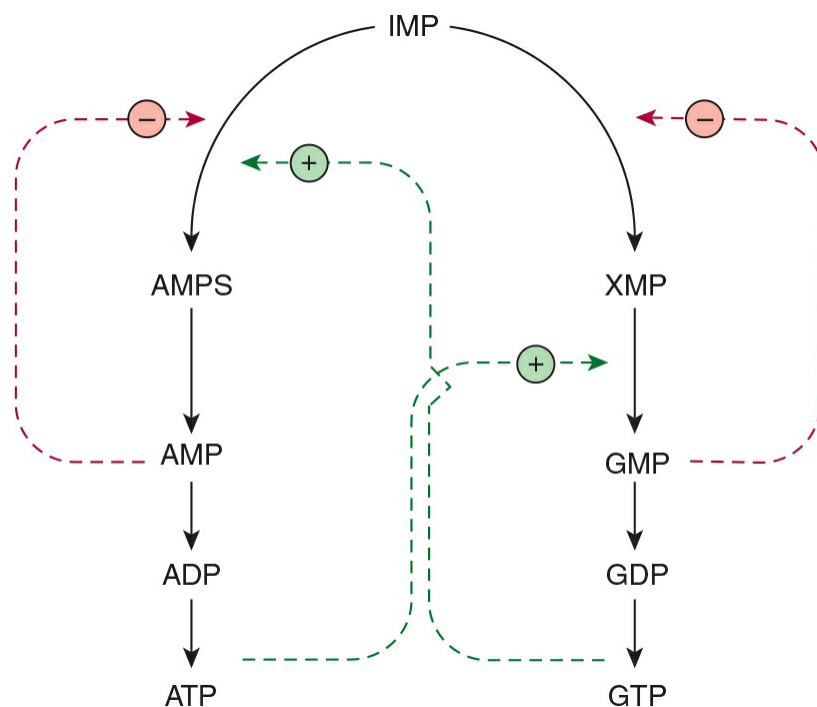

FIGURE 33–6 Regulation of the conversion of IMP to adenosine nucleotides and guanosine nucleotides. Solid lines represent chemical flow. Broken green lines represent positive feedback loops Symbol ⊕, and broken red lines represent negative feedback loops Symbol ⊖. (AMPS, adenylosuccinate; XMP, xanthosine monophosphate; their structures are given in **Figure 33–3**.)

REDUCTION OF RIBONUCLEOSIDE

DIPHOSPHATES FORMS DEOXYRIBONUCLEOSIDE DIPHOSPHATES

Reduction of the 2'-hydroxyl of purine and pyrimidine ribonucleotides, catalyzed by the complex that includes **ribonucleotide reductase**, EC 1.17.4.1 (**Figure 33–7**), provides the deoxyribonucleoside diphosphates (dNDPs) needed for both the synthesis and repair of DNA (see **Chapter 35**). The enzyme complex is functional only when cells are actively synthesizing DNA. Reduction requires reduced thioredoxin, thioredoxin reductase (EC 1.8.1.9), and NADPH. The immediate reductant, reduced thioredoxin, is produced by NADPH-dependent reduction of oxidized thioredoxin (Figure 33–7). The reduction of ribonucleoside diphosphates (NDPs) to dNDPs is subject to complex regulatory controls that achieve balanced production of dNTPs for synthesis of DNA (**Figure 33–8**).

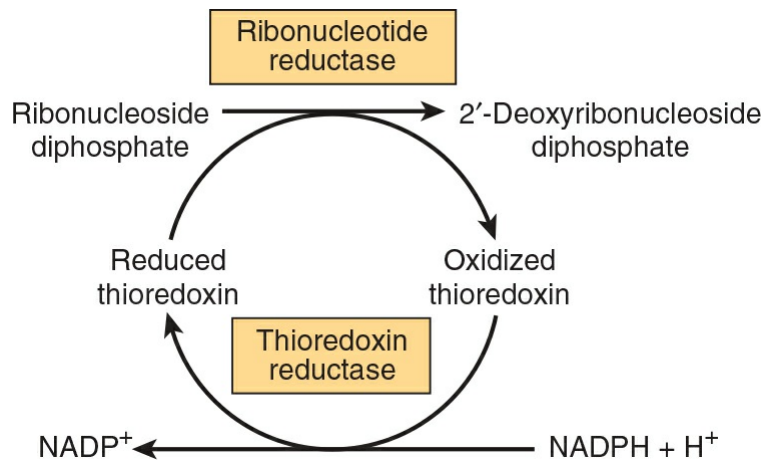

FIGURE 33–7 Reduction of ribonucleoside diphosphates to 2'-deoxyribonucleoside diphosphates.

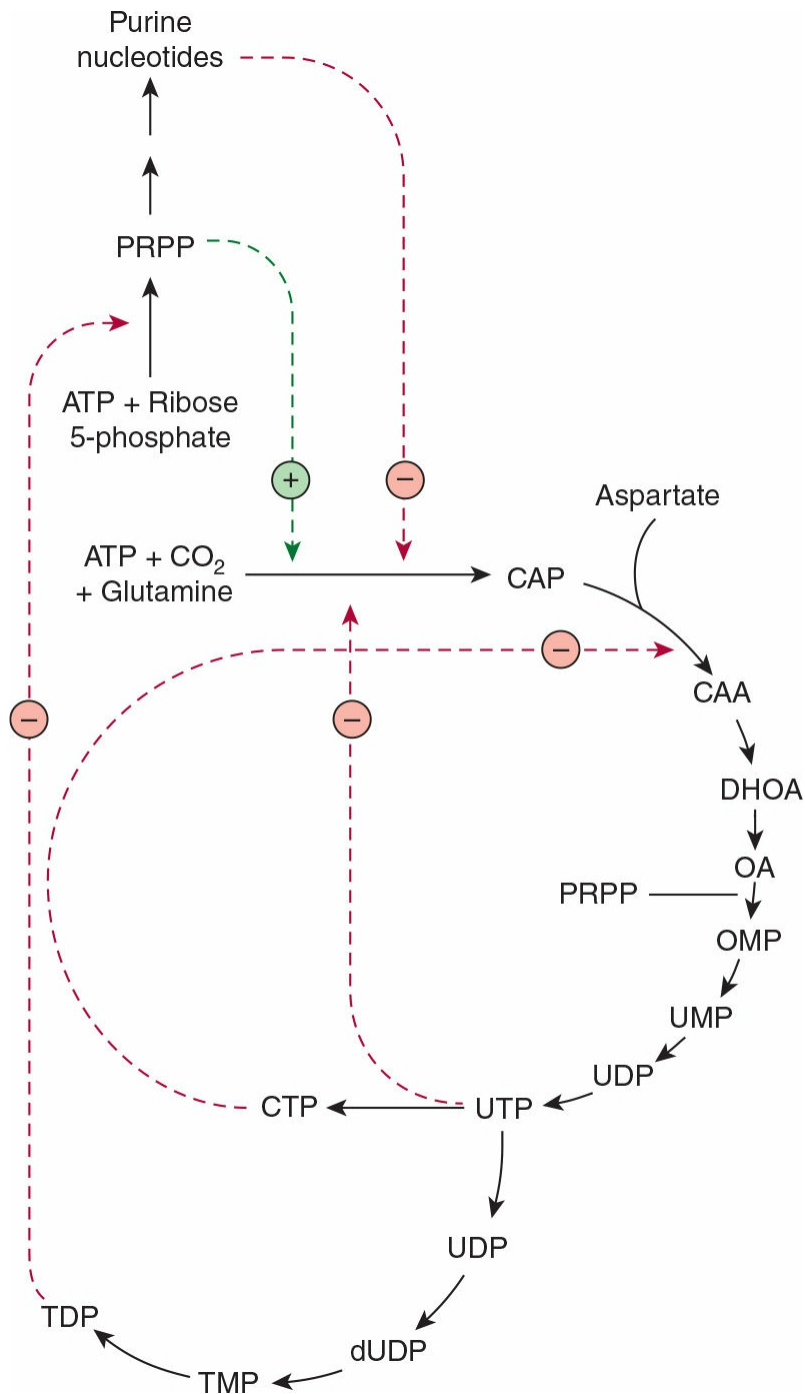

FIGURE 33–8 Regulatory aspects of the biosynthesis of purine and pyrimidine ribonucleotides and reduction to their respective 2'-deoxyribonucleotides. The broken green line represents a positive feedback loop. Broken red lines represent negative feedback loops. Abbreviations are provided for the intermediates in the biosynthesis of pyrimidine nucleotides whose structures are given in [Figure 33–9](#). (CAA, carbamoyl aspartate; DHOA, dihydroorotate; OA, orotic acid; OMP, orotidine monophosphate; PRPP, phosphoribosyl pyrophosphate.)

BIOSYNTHESIS OF PYRIMIDINE NUCLEOTIDES

Figure 33–9 illustrates the intermediates and enzymes of pyrimidine nucleotide biosynthesis. The catalyst for the initial reaction is *cytosolic* carbamoyl phosphate synthetase II (EC 6.3.5.5), a different enzyme from the *mitochondrial* carbamoyl phosphate synthetase I of urea synthesis (see **Figure 28–16**). Compartmentation thus provides an independent pool of carbamoyl phosphate for each process. Unlike in purine biosynthesis where PRPP serves as a scaffold for assembly of the purine ring (**Figure 33–2**), PRPP participates in pyrimidine biosynthesis only subsequent to assembly of the pyrimidine ring. As for the biosynthesis of pyrimidines, purine nucleoside biosynthesis is energetically costly.

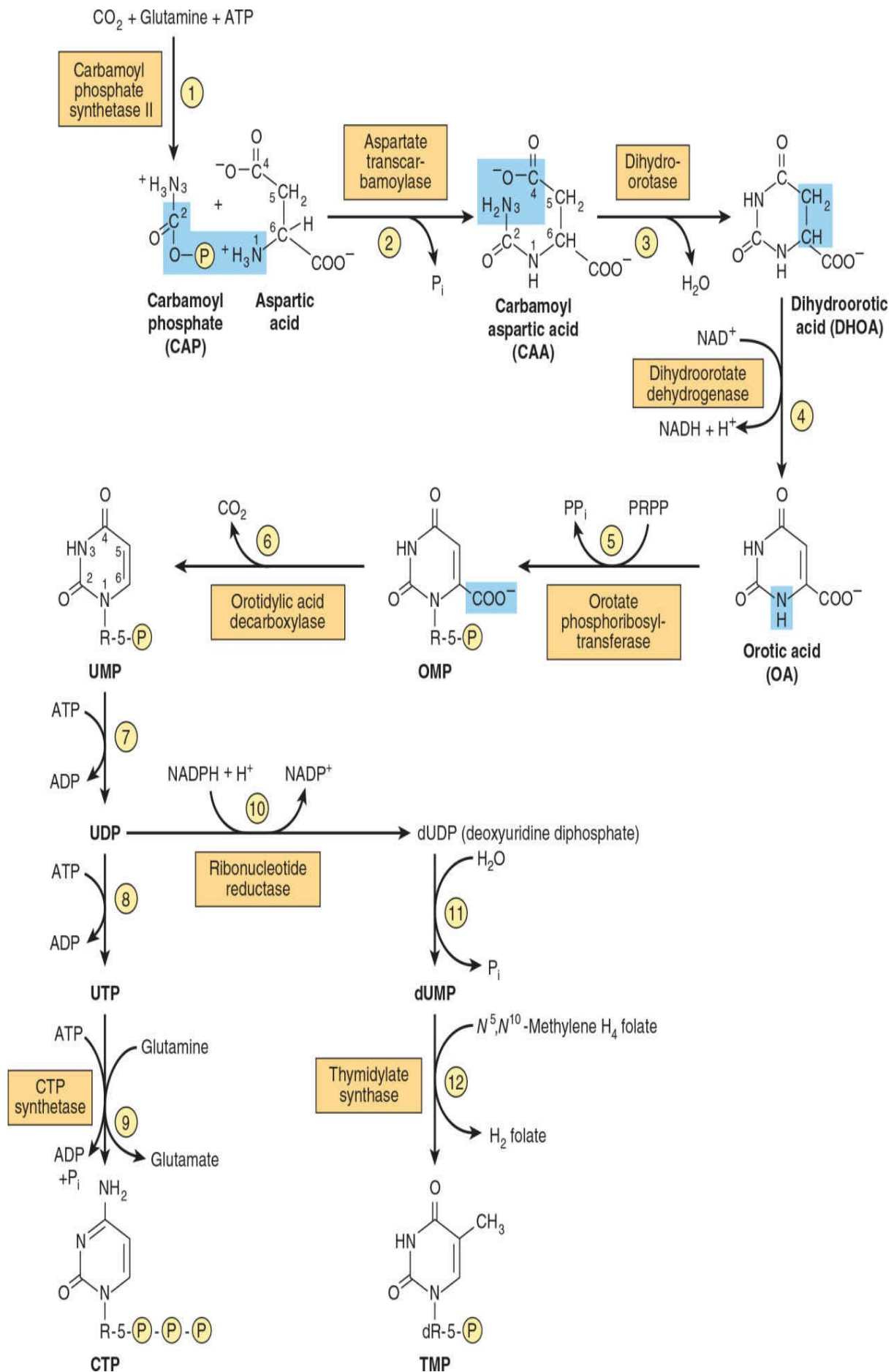

FIGURE 33–9 The biosynthetic pathway for pyrimidine nucleotides.

Multifunctional Proteins Catalyze the Early Reactions of Pyrimidine Biosynthesis

Five of the first six enzyme activities of pyrimidine biosynthesis reside on **multifunctional polypeptides**. CAD, a single polypeptide named for the first letters of its enzyme activities, catalyzes the first three reactions of [Figure 33–9](#). A second bifunctional enzyme catalyzes reactions ⑤ and ⑥ of [Figure 33–9](#). The close proximity of multiple active sites on a multifunctional polypeptide facilitates efficient channeling of the intermediates of pyrimidine biosynthesis.

THE DEOXYRIBONUCLEOSIDES OF URACIL & CYTOSINE ARE SALVAGED

Adenine, guanine, and hypoxanthine released during the turnover of nucleic acids, notably messenger RNAs, are reconverted to nucleoside triphosphates via so-called **salvage pathways**. While mammalian cells reutilize few *free* pyrimidines, “salvage reactions” convert the pyrimidine ribonucleosides uridine and cytidine and the pyrimidine deoxyribonucleosides thymidine and deoxycytidine to their respective nucleotides.

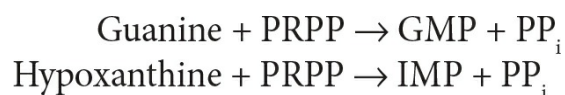

Phosphoryltransferases (kinases) catalyze transfer of the γ -phosphoryl group of ATP to the diphosphates of the dNDPs 2'-deoxycytidine, 2'-deoxyguanosine, and 2'-deoxyadenosine, converting them to the corresponding nucleoside triphosphates.

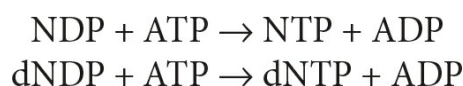

Methotrexate Blocks Reduction of Dihydrofolate

The reaction catalyzed by thymidylate synthase, EC 2.1.1.45 (reaction ⑫ of [Figure 33–9](#)) is the only reaction of pyrimidine nucleotide biosynthesis that requires a tetrahydrofolate derivative. During this reaction, the

methylene group of N^5,N^{10} -methylene-tetrahydrofolate is reduced to the methyl group that is transferred to the 5-position of the pyrimidine ring, and tetrahydrofolate is oxidized to dihydrofolate. For further pyrimidine synthesis to occur, dihydrofolate must be reduced back to tetrahydrofolate. This reduction, catalyzed by dihydrofolate reductase (EC 1.5.1.3), is inhibited by **methotrexate**. Dividing cells, which must generate TMP and dihydrofolate, thus are especially sensitive to inhibitors of dihydrofolate reductase such as the anticancer drug methotrexate.

Certain Pyrimidine Analogs Are Substrates for Enzymes of Pyrimidine Nucleotide Biosynthesis

Allopurinol and the anticancer drug **5-fluorouracil** (see [Figure 32–13](#)) are alternate substrates for orotate phosphoribosyltransferase, EC 2.4.2.10 (reaction ⑤, [Figure 33–9](#)). Both drugs are phosphoribosylated, and allopurinol is converted to a nucleotide in which the ribosyl phosphate is attached to N^1 of the pyrimidine ring.

REGULATION OF PYRIMIDINE NUCLEOTIDE BIOSYNTHESIS

Gene Expression & Enzyme Activity Both Are Regulated

CAD represents the primary focus for regulation of pyrimidine biosynthesis. Expression of the CAD gene is regulated at the level both of transcription and of translation. At the level of enzyme activity, the carbamoyl phosphate synthetase II (CPS) activity of CAD is activated by PRPP and is feedback inhibited by UTP. The effect of UTP is, however, abolished by phosphorylation of serine 1406 of CAD.

Purine & Pyrimidine Nucleotide Biosynthesis Are Coordinately Regulated

Purine and pyrimidine biosynthesis parallel one another quantitatively, that is, mole for mole, suggesting coordinated control of their biosynthesis. Several sites of *cross-regulation* characterize the pathways that lead to the biosynthesis of purine and pyrimidine nucleotides. PRPP synthetase (reaction ①, [Figure 33–2](#)), which forms a precursor essential for both processes, is feedback inhibited by both purine and pyrimidine

nucleotides, as is the conversion of both pyrimidine and purine nucleotides NDPs to NTPs (**Figure 33–10**).

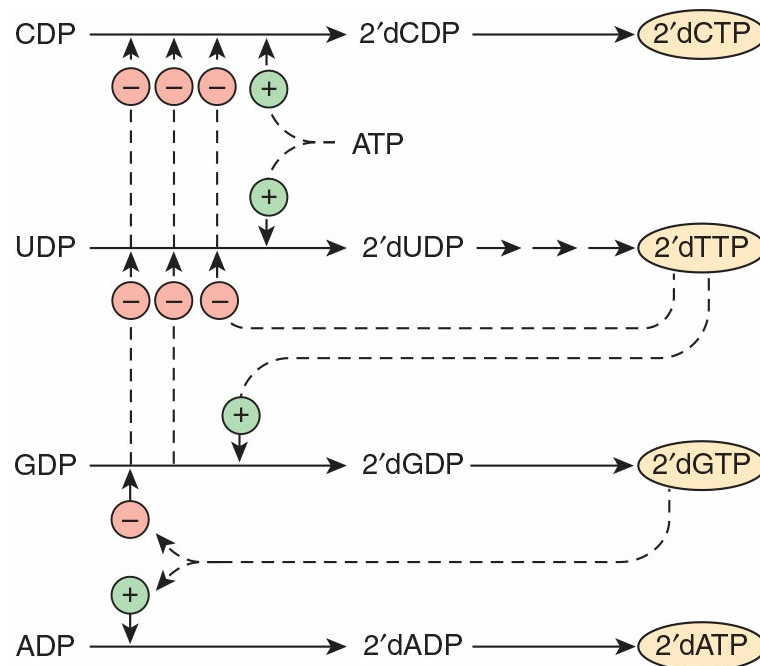

FIGURE 33–10 Regulation of the conversion of purine and pyrimidine NDPs to NTPs. Solid lines represent chemical flow. Broken lines indicate targets of positive Symbol \oplus or negative Symbol \ominus feedback inhibition.

HUMANS CATABOLIZE PURINES TO URIC ACID

Humans convert adenosine and guanosine to uric acid (**Figure 33–11**). Adenosine is first converted to inosine by adenosine deaminase, EC 3.5.4.4. In mammals other than higher primates, uricase (EC 1.7.3.3) converts uric acid to the water-soluble product allantoin. However, since humans lack uricase, the end product of purine catabolism in humans is uric acid.

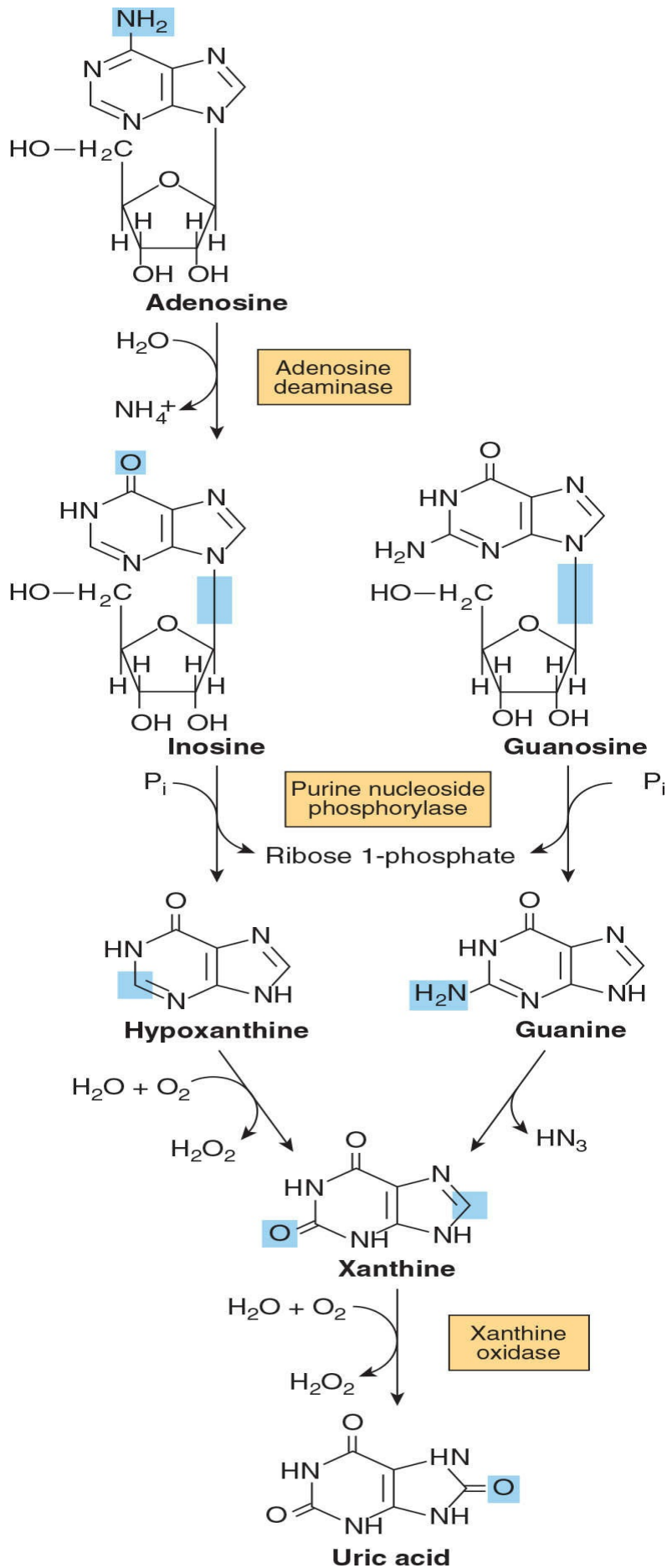

FIGURE 33–11 Formation of uric acid from purine nucleosides by way of the purine bases hypoxanthine, xanthine, and guanine. Purine deoxyribonucleosides are degraded by the same catabolic pathway and enzymes, all of which exist in the mucosa of the mammalian gastrointestinal tract.

DISORDERS OF PURINE METABOLISM

Various genetic defects in PRPP synthetase (reaction ①, [Figure 33–2](#)) present clinically as gout. Each defect—for example, an elevated V_{\max} , increased affinity for ribose 5-phosphate, or resistance to feedback inhibition—results in overproduction and overexcretion of purine catabolites. When serum urate levels exceed the solubility limit, sodium urate crystallizes in soft tissues and joints and causes an inflammatory reaction, **gouty arthritis**. However, most cases of gout reflect abnormalities in renal handling of uric acid.

While purine deficiency states are rare in human subjects, there are numerous genetic disorders of purine catabolism. **Hyperuricemias** may be differentiated based on whether patients excrete normal or excessive quantities of total urates. Some hyperuricemias reflect specific enzyme defects. Others are secondary to diseases such as cancer or psoriasis that enhance tissue turnover.

Lesch-Nyhan Syndrome

The Lesch-Nyhan syndrome, an overproduction hyperuricemia characterized by frequent episodes of uric acid lithiasis and a bizarre syndrome of self-mutilation, reflects a defect in **hypoxanthine-guanine phosphoribosyl transferase**, an enzyme of purine salvage ([Figure 33–4](#)). The accompanying rise in intracellular PRPP results in purine overproduction. Mutations that decrease or abolish hypoxanthine-guanine phosphoribosyltransferase activity include deletions, frame-shift mutations, base substitutions, and aberrant mRNA splicing.

von Gierke Disease

Purine overproduction and hyperuricemia in von Gierke disease (**glucose-6-phosphatase deficiency**) occurs secondary to enhanced generation of the PRPP precursor ribose 5-phosphate. An associated lactic acidosis elevates the renal threshold for urate, elevating total body urates.

Hypouricemia

Hypouricemia and increased excretion of hypoxanthine and xanthine are associated with a deficiency in **xanthine oxidase**, EC 1.17.3.2 (Figure 33–11) due to a genetic defect or to severe liver damage. Patients with a severe enzyme deficiency may exhibit xanthinuria and xanthine lithiasis.

Adenosine Deaminase & Purine Nucleoside Phosphorylase Deficiency

Adenosine deaminase deficiency (Figure 33–11) is associated with an immunodeficiency disease in which both thymus-derived lymphocytes (T cells) and bone marrow–derived lymphocytes (B cells) are sparse and dysfunctional. Patients suffer from severe immunodeficiency. In the absence of enzyme replacement or bone marrow transplantation, infants often succumb to fatal infections. Defective activity of **purine nucleoside phosphorylase** (EC 2.4.2.1) is associated with a severe deficiency of T cells, but apparently normal B-cell function. Immune dysfunctions appear to result from accumulation of dGTP and dATP, which inhibit ribonucleotide reductase and thereby deplete cells of DNA precursors.

Table 33–1 summarizes known disorders of purine metabolism.

PYRIMIDINE CATABOLITES ARE WATER SOLUBLE

Unlike the low solubility products of purine catabolism, catabolism of the pyrimidines forms highly water-soluble products—CO₂, NH₃, β-alanine, and β-aminoisobutyrate (Figure 33–12). Excretion of β-aminoisobutyrate increases in leukemia and severe x-ray radiation exposure due to increased destruction of DNA. However, many persons of Chinese or Japanese ancestry routinely excrete β-aminoisobutyrate.

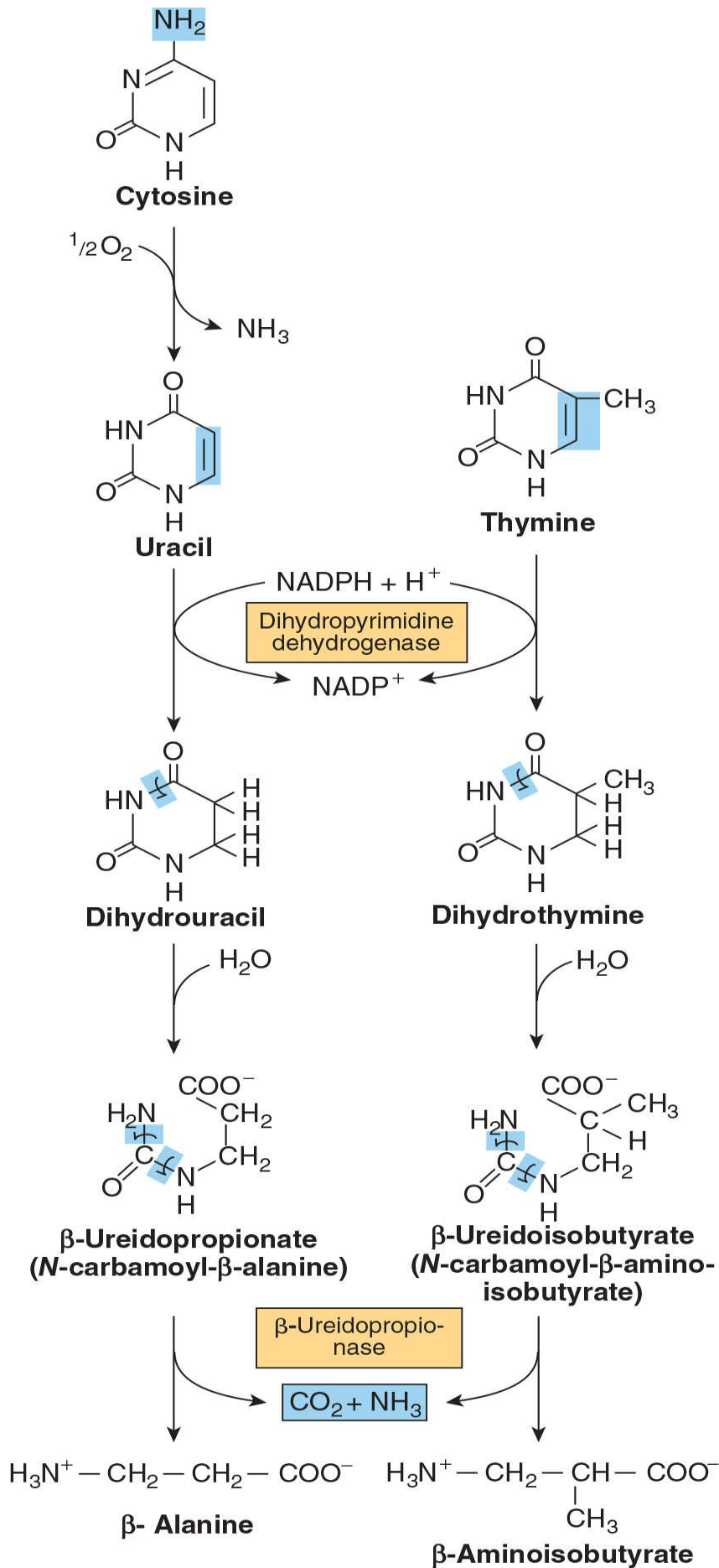

FIGURE 33–12 Catabolism of pyrimidines. Hepatic β -ureidopropionase catalyzes the formation of both β -alanine and β -aminoisobutyrate from their pyrimidine precursors.

Disorders of β -alanine and β -aminoisobutyrate metabolism arise from defects in enzymes of pyrimidine catabolism. These include **β -hydroxybutyric aciduria**, a disorder due to total or partial deficiency of the enzyme **dihydropyrimidine dehydrogenase**, EC 1.3.1.2 (Figure 33–12). The genetic disease reflects an absence of the enzyme. A disorder of pyrimidine catabolism, known also as combined uraciluria-thyminuria, is also a disorder of β -amino acid metabolism, since the *formation* of β -alanine and of β -aminoisobutyrate is impaired. When caused by a genetic error, there are serious neurologic complications. A nongenetic form is triggered by the administration of the anticancer drug 5-fluorouracil (see Figure 32–13) to patients with low levels of dihydropyrimidine dehydrogenase.

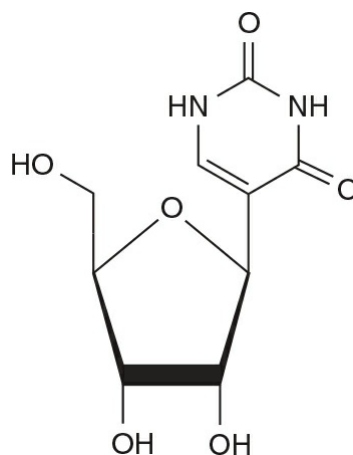

FIGURE 33–13 Pseudouridine, in which ribose is linked to C5 of uridine.

Pseudouridine Is Excreted Unchanged

No human enzyme catalyzes hydrolysis or phosphorolysis of the pseudouridine (ψ) derived from the degradation of RNA molecules. This unusual nucleotide therefore is excreted unchanged in the urine of normal subjects. Pseudouridine was indeed first isolated from human urine (Figure 33–13).

OVERPRODUCTION OF PYRIMIDINE

CATABOLITES

Since the end products of pyrimidine catabolism are highly water soluble, pyrimidine overproduction results in few clinical signs or symptoms. [Table 33–1](#) lists exceptions. In hyperuricemia associated with severe overproduction of PRPP, there is overproduction of pyrimidine nucleotides and increased excretion of β -alanine. Since N^5, N^{10} -methylene-tetrahydrofolate is required for thymidylate synthesis, disorders of folate and vitamin B₁₂ metabolism result in deficiencies of TMP.

TABLE 33–1 Metabolic Disorders of Purine and Pyrimidine Metabolism

Defective Enzyme	Enzyme Catalog Number	OMIM Reference	Major Signs and Symptoms	Figure and Reaction
Purine Metabolism				
Hypoxanthine-guanine phosphoribosyl transferase	2.4.2.8	308000	Lesch-Nyhan syndrome. Uricemia, self-mutilation	33-4 ②
PRPP synthase	2.7.6.1	311860	Gout; gouty arthritis	33-2 ①
Adenosine deaminase	3.5.4.6	102700	Severely compromised immune system	33-1 ①
Purine nucleoside phosphorylase	2.4.2.1	164050	Autoimmune disorders; benign and opportunistic infections	33-11 ②
Pyrimidine Metabolism				
Dihydropyrimidine dehydrogenase	1.3.1.2	274270	Can develop toxicity to 5-fluorouracil, also a substrate for this dehydrogenase	33-12 ②
Orotate phosphoribosyl transferase and orotidylic acid decarboxylase	2.4.2.10 and 4.1.1.23	258900	Orotic acid aciduria type 1; megaloblastic anemia	33-9 ⑤ and ⑥
Orotidylic acid decarboxylase	4.1.1.23	258920	Orotic acid aciduria type 2	33-9 ⑥

Orotic Aciduria

The orotic aciduria that accompanies the **Reye syndrome** probably is a consequence of the inability of severely damaged mitochondria to utilize carbamoyl phosphate, which then becomes available for cytosolic

overproduction of orotic acid. **Type I orotic aciduria** reflects a deficiency of both orotate phosphoribosyltransferase (EC 2.1.3.3) and orotidylate decarboxylase, EC 4.1.1.23 (reactions ⑤ and ⑥, [Figure 33–9](#)). The rarer **Type II orotic aciduria** is due to a deficiency only of orotidylate decarboxylase (reaction ⑥, [Figure 33–9](#)).

Deficiency of a Urea Cycle Enzyme Results in Excretion of Pyrimidine Precursors

Increased excretion of orotic acid, uracil, and uridine accompanies a deficiency in liver mitochondrial ornithine transcarbamoylase (see reaction ②, [Figure 28–16](#)). Excess carbamoyl phosphate exits to the cytosol, where it stimulates pyrimidine nucleotide biosynthesis. The resulting mild **orotic aciduria** is increased by high-nitrogen foods.

Drugs May Precipitate Orotic Aciduria

Allopurinol (see [Figure 32–13](#)), an alternative substrate for orotate phosphoribosyltransferase (reaction ⑤, [Figure 33–9](#)), competes with orotic acid. The resulting nucleotide product also inhibits orotidylate decarboxylase (reaction ⑥, [Figure 33–9](#)), resulting in **orotic aciduria** and **orotidinuria**. 6-Azauridine, following conversion to 6-azauridylylate, also competitively inhibits orotidylate decarboxylase (reaction ⑥, [Figure 33–9](#)), enhancing excretion of orotic acid and orotidine. Four genes that encode urate transporters have been identified. Two of the encoded proteins are localized to the apical membrane of proximal tubular cells.

SUMMARY

- Ingested nucleic acids are degraded to purines and pyrimidines. Purines and pyrimidines are formed from amphibolic intermediates and thus are dietarily nonessential.
- Several reactions of IMP biosynthesis require folate derivatives and glutamine. Consequently, antifolate drugs and glutamine analogs inhibit purine biosynthesis.
- IMP is a precursor both of AMP and GMP. Glutamine provides the 2-amino group of GMP, and aspartate the 6-amino group of AMP.
- Phosphoryl transfer from ATP converts AMP and GMP to ADP and GDP. A second phosphoryl transfer from ATP forms GTP, but ADP is converted to ATP primarily by oxidative phosphorylation.

- Hepatic purine nucleotide biosynthesis is stringently regulated by the pool size of PRPP and by feedback inhibition of PRPP glutamyl amidotransferase by AMP and GMP.
- Coordinated regulation of purine and pyrimidine nucleotide biosynthesis ensures their presence in proportions appropriate for nucleic acid biosynthesis and other metabolic needs.
- Humans catabolize purines to uric acid (pK_a 5.8), present as the relatively insoluble acid at acidic pH or as its more soluble sodium urate salt at a pH near neutrality. Urate crystals are diagnostic of gout. Other disorders of purine catabolism include Lesch-Nyhan syndrome, von Gierke disease, and hypouricemias.
- Since pyrimidine catabolites are water soluble, their overproduction does not result in clinical abnormalities. Excretion of pyrimidine precursors can, however, result from a deficiency of ornithine transcarbamoylase because excess carbamoyl phosphate is available for pyrimidine biosynthesis.

REFERENCES

- Brassier A, Ottolenghi C, Boutron A, et al: Dihydrolipoamide dehydrogenase deficiency: a still overlooked cause of recurrent acute liver failure and Reye-like syndrome. *Mol Genet Metab* 2013;109:28.
- Fu R, Jinnah HA: Genotype-phenotype correlations in Lesch-Nyhan disease: moving beyond the gene. *J Biol Chem* 2012;287:2997.
- Fu W, Li Q, Yao J, et al: Protein expression of urate transporters in renal tissue of patients with uric acid nephrolithiasis. *Cell Biochem Biophys* 2014;70:449.
- Moyer RA, John DS: Acute gout precipitated by total parenteral nutrition. *J Rheumatol* 2003;30:849.
- Uehara I, Kimura T, Tanigaki S, et al: Paracellular route is the major urate transport pathway across the blood-placental barrier. *Physiol Rep* 2014;20:2.
- Wu VC, Huang JW, Hsueh PR, et al: Renal hypouricemia is an ominous sign in patients with severe acute respiratory syndrome. *Am J Kidney Dis* 2005;45:88.

Nucleic Acid Structure & Function

P. Anthony Weil, PhD

OBJECTIVES

After studying this chapter, you should be able to:

- Understand the chemical monomeric and polymeric structure of the genetic material, deoxyribonucleic acid, or DNA, which is found within the nucleus of eukaryotic cells.
- Explain why genomic DNA is double stranded and highly negatively charged.
- Understand the outline of how the genetic information of DNA can be faithfully duplicated.
- Describe how the genetic information of DNA is transcribed, or copied, into myriad, distinct forms of ribonucleic acid (RNA).
- Appreciate that one form of information-rich RNA, the so-called messenger RNA (mRNA), can be subsequently translated into proteins, the molecules that form the structures, shapes, and ultimately functions of individual cells, tissues, and organs.

BIOMEDICAL IMPORTANCE

The discovery that genetic information is coded along the length of a polymeric molecule composed of only four types of monomeric units was one of the major scientific achievements of the 20th century. This polymeric molecule, **deoxyribonucleic acid (DNA)**, is the chemical basis of heredity and is organized into genes, the fundamental units of genetic information. The basic information pathway—that is, DNA, which directs the synthesis of RNA, which in turn both directs and regulates protein synthesis—has been elucidated. Genes do not function autonomously; rather their replication and function are controlled by various gene products, often in collaboration with components of various signal transduction pathways. Knowledge of the structure and function of nucleic acids is essential in understanding genetics and many aspects of pathophysiology as well as the genetic basis of disease.

DNA CONTAINS THE GENETIC INFORMATION

The demonstration that DNA contained the genetic information was first made in 1944 in a series of experiments by Avery, MacLeod, and McCarty. They showed that the genetic determination of the character (type) of the capsule of a specific pneumococcus bacterium could be transmitted to another of a different capsular type by introducing purified DNA from the former pneumococcus into the latter. These authors referred to the agent (later shown to be DNA) accomplishing the change as “transforming factor.” Subsequently, this type of genetic manipulation has become commonplace. Conceptually similar experiments now are regularly performed utilizing a variety of eukaryotic cells, including human cells and mammalian embryos as recipients and molecularly cloned DNA as the donor of genetic information.

DNA Contains Four Deoxynucleotides

The chemical nature of the monomeric deoxynucleotide units of DNA—**deoxyadenylate, deoxyguanylate, deoxycytidylate, and thymidylate**—is described in [Chapter 32](#). These monomeric units of DNA are held in polymeric form by 3',5'-phosphodiester bonds constituting a single strand, as depicted in [Figure 34–1](#). The informational content of DNA (the genetic code) resides in the sequence in which these monomers—purine and pyrimidine deoxyribonucleotides—are ordered. The polymer as depicted possesses a polarity; one end has a 5'-hydroxyl or phosphate terminus while the other has a 3'-phosphate or hydroxyl terminus. The importance of this polarity will become evident. Since the genetic

information resides in the order of the monomeric units within the polymers, there must exist a mechanism of reproducing or replicating this specific information with a high degree of fidelity. That requirement, together with x-ray diffraction data from the DNA molecule generated by Franklin, and the observation of Chargaff that in DNA molecules the concentration of deoxyadenosine (A) nucleotides equals that of thymidine (T) nucleotides ($A = T$), while the concentration of deoxyguanosine (G) nucleotides equals that of deoxycytidine (C) nucleotides ($G = C$), led Watson, Crick, and Wilkins to propose in the early 1950s a model of a double-stranded DNA molecule. The model they proposed is depicted in [Figure 34–2](#). The two strands of this double-stranded helix are held in register by both **hydrogen bonds** between the purine and pyrimidine bases of the respective linear molecules and by **van der Waals** and **hydrophobic interactions** between the stacked adjacent base pairs. The pairings between the purine and pyrimidine nucleotides on the opposite strands are very specific and are dependent on hydrogen bonding of **A with T** and **G with C** ([Figure 34–2](#)). **A–T** and **G–C base pairs** are often referred to as **Watson-Crick base pairs**.

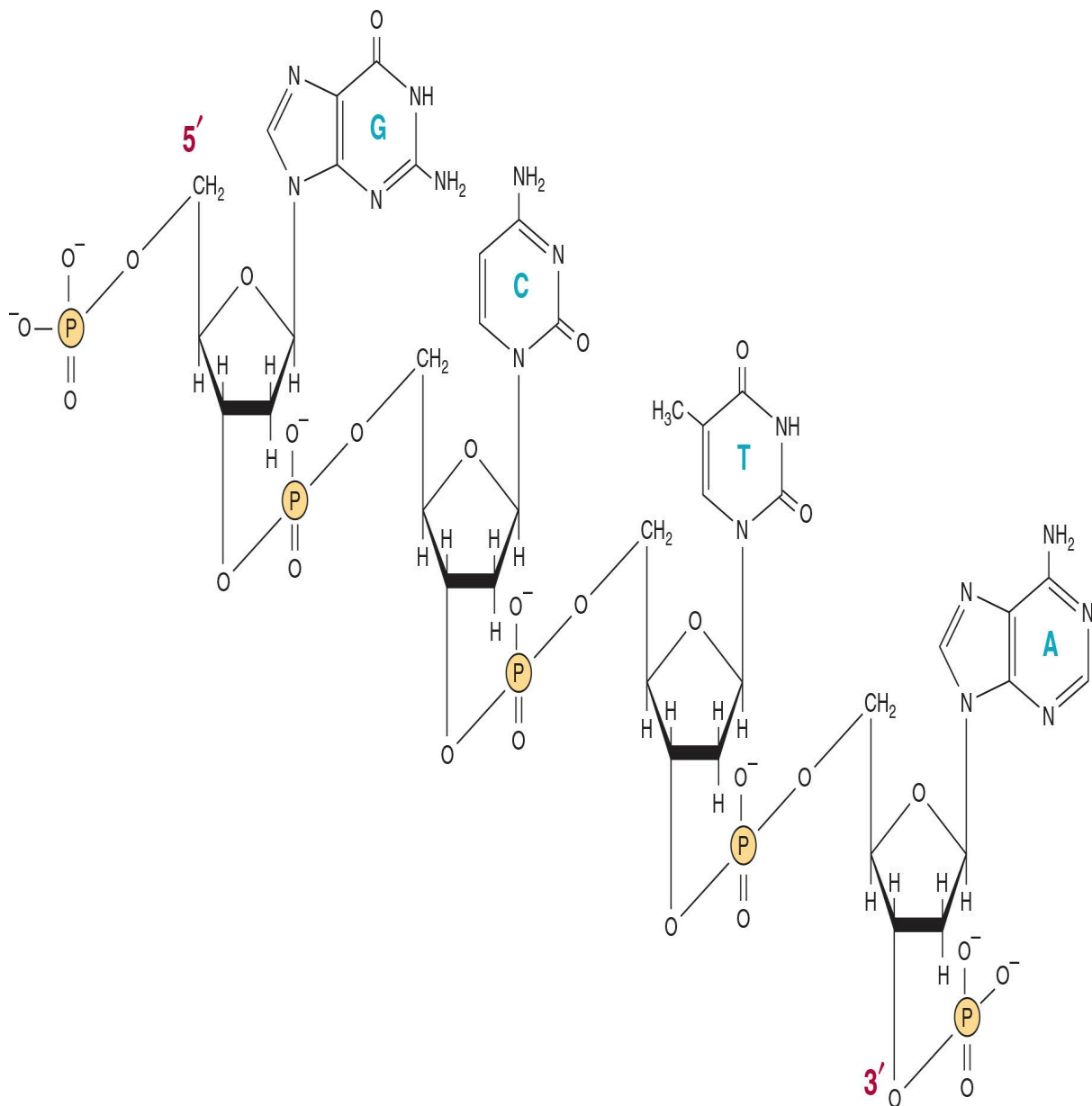

FIGURE 34–1 A segment of one strand of a DNA molecule in which the purine and pyrimidine bases guanine (G), cytosine (C), thymine (T), and adenine (A) are held together by a phosphodiester backbone between 2'-deoxyribosyl moieties attached to the nucleobases by an *N*-glycosidic bond. Note that the phosphodiester backbone is negatively charged and has a polarity (ie, a direction). Convention dictates that a single-stranded DNA sequence is written in the 5' to 3' direction (ie, pGpCpTpAp, where G, C, T, and A represent the four bases and p represents the interconnecting phosphates).

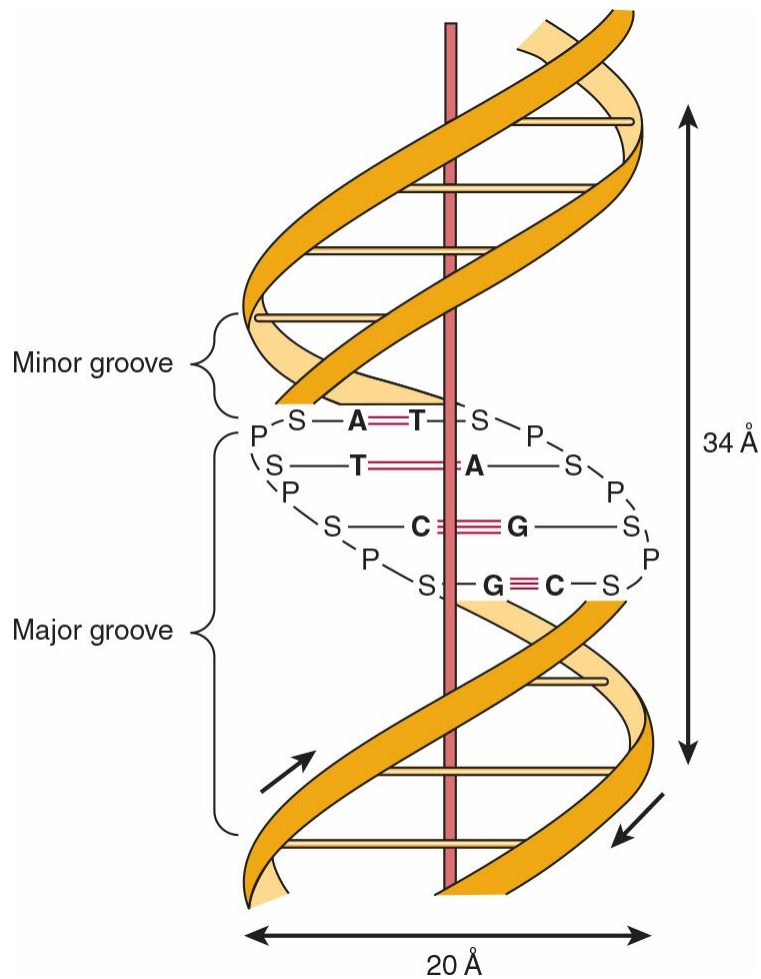

FIGURE 34-2 A diagrammatic representation of the Watson and Crick model of the double-helical structure of the B form of DNA. The horizontal arrow indicates the width of the double helix (20 Å), and the vertical arrow indicates the distance spanned by one complete turn of the double helix (34 Å). One turn of B-DNA includes 10 base pairs (bp), so the rise is 3.4 Å per bp. The central axis of the double helix is indicated by the vertical rod. The short arrows designate the polarity of the antiparallel strands. The major and minor grooves are depicted. (A, adenine; C, cytosine; G, guanine; P, phosphate; S, sugar [deoxyribose]; T, thymine.) Hydrogen bonds between A/T and G/C bases indicated by short, red, horizontal lines.

This common form of DNA is said to be right handed because as one looks down the double helix, the base residues form a spiral in a clockwise direction. In the double-stranded molecule, restrictions imposed by the rotation about the phosphodiester bond, the favored *anti*-configuration of the glycosidic bond (see [Figure 32-5](#)), and the predominant tautomers (see [Figure 32-2](#)) of the four bases (A, G, T, and C) allow A to pair only with

T, and G only with C, as depicted in [Figure 34–3](#). These base-pairing restrictions explain the earlier observation that in a double-stranded DNA molecule the content of A equals that of T and the content of G equals that of C. The two strands of the double-helical molecule, each of which possesses a **polarity**, are **antiparallel**; that is, one strand runs in the 5' to 3' direction and the other in the 3' to 5' direction. Within a particular gene in the double-stranded DNA molecules, the genetic information resides in the sequence of nucleotides on one strand, the **template strand**. This is the strand of DNA that is copied, or transcribed, during **ribonucleic acid (RNA)** synthesis. It is sometimes referred to as the **noncoding strand**. The opposite strand is considered the **coding strand** because it matches the sequence of the RNA transcript (but containing uracil in place of thymine; [Figure 34–8](#)) that encodes the protein.

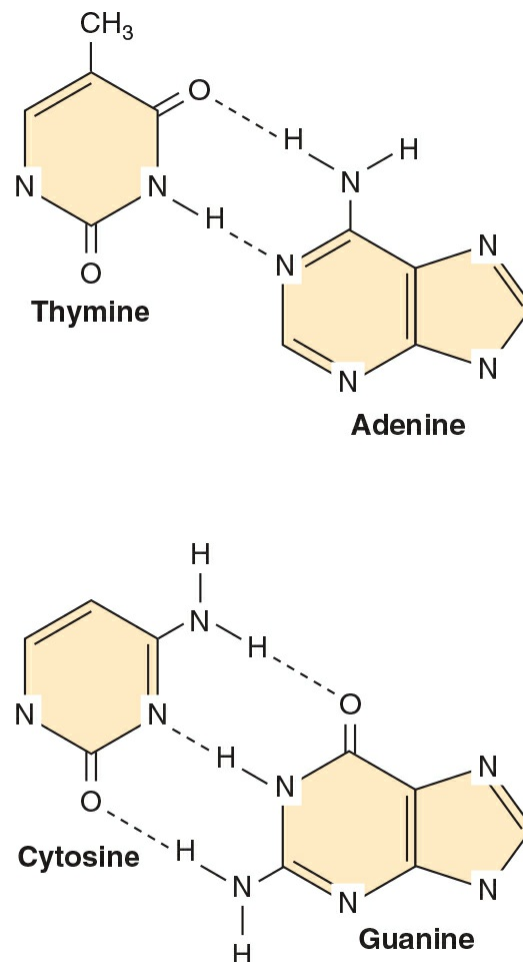

FIGURE 34–3 Classic Watson-Crick DNA base pairing between complementary deoxynucleotides involves the formation of hydrogen bonds. Two such H-bonds form between adenine and thymine, and three H-bonds form between cytosine and guanine. The broken lines represent H-bonds.

The two strands, in which opposing bases are held together by interstrand hydrogen bonds, wind around a central axis in the form of a **double helix**. In the test tube, double-stranded DNA can exist in at least six forms (A–E and Z). These different forms of DNA differ with regard to intra- and interstrand interactions and involve structural rearrangements within the monomeric units of DNA. The **B form is usually found under physiologic conditions**. A single turn of B form DNA about the long axis of the molecule contains 10 bp. The distance spanned by one turn of B-DNA is 3.4 nm (34 Å). The width (helical diameter) of the double helix in B-DNA is 2 nm (20 Å).

As depicted in [Figure 34–3](#), three hydrogen bonds (see [Figure 2–2](#)), formed by hydrogen bonded to electronegative N or O atoms, hold the deoxyguanosine nucleotide to the deoxycytidine nucleotide, whereas the other pair, the A–T pair, is held together by two hydrogen bonds. Note that the four DNA nucleotide bases ([dG, dA] purines and [dT, dC] pyrimidines; see [Figures 32–1](#) and [Table 32-1](#)) are flat, planar molecules. These fundamental properties of the nucleotide bases allow them to closely stack within duplex DNA ([Figure 34–2](#)). The atoms within the aromatic, heterocyclic bases are highly polarizable, and, coupled with the fact that many of the atoms within the bases contain partial charges, allows for the stacked bases to form van der Waals and electrostatic interactions. These forces are collectively referred to as base-stacking forces or interactions. Base-stacking interactions between adjacent G–C (or C–G) base pairs are stronger than A–T (or T–A) base pairs. Thus, the G–C rich DNA sequences are more resistant to denaturation, or strand separation, termed “melting,” than A–T-rich regions of DNA.

The Denaturation of DNA Is Used to Analyze Its Structure

The double-stranded structure of DNA can be separated into two component strands in solution by increasing the temperature or decreasing the salt concentration. Not only do the two stacks of bases pull apart, but the bases themselves unstack while still connected in the polymer by the phosphodiester backbone. Concomitant with this denaturation of the DNA molecule is an increase in the optical absorbance of the purine and pyrimidine bases—a phenomenon referred to as **hyperchromicity** of denaturation. Because of the stacking of the bases and the hydrogen bonding between the stacks, the double-stranded DNA molecule exhibits properties of a rigid rod and in solution is a viscous material that loses its

viscosity upon denaturation.

The strands of a given molecule of DNA separate over a temperature range. The midpoint is called the **melting temperature**, or T_m . The T_m is influenced by the base composition of the DNA and by the salt concentration (or other solutes, see below) of the solution. DNA rich in G–C pairs, which have three hydrogen bonds, melts at a higher temperature than DNA rich in A–T pairs, which have two hydrogen bonds. A 10-fold increase of monovalent cation concentration increases the T_m by 16.6°C by neutralizing the intrinsic interchain repulsion between the highly negatively charged phosphates of the phosphodiester backbone. Conversely, the organic solvent formamide, which is commonly used in recombinant DNA experiments, destabilizes hydrogen bonding between bases, thereby lowering the T_m . Formamide addition allows the strands of DNA or DNA–RNA hybrids to be separated at much lower temperatures and minimizes the phosphodiester bond breakage and chemical damage to nucleotides that can occur upon extended incubation at higher temperatures.

Renaturation of DNA Requires Base Pair Matching

Importantly, separated strands of DNA will renature or reassociate when appropriate physiologic temperature and salt conditions are achieved; this reannealing process is often referred to as **hybridization**. The rate of reassociation depends on the concentration of the complementary strands. Reassociation of the two complementary DNA strands of a chromosome after transcription is a physiologic example of renaturation (see below). At a given temperature and salt concentration, a particular nucleic acid strand will associate tightly only with a complementary strand. Hybrid molecules will also form under appropriate conditions. For example, DNA will form a hybrid with a complementary DNA (cDNA) or with a cognate complementary RNA (eg, mRNA; see below). When hybridization is combined with gel electrophoresis techniques that separate nucleic acids by size, coupled with radioactive or fluorescent complementary probe labeling to provide a detectable signal, the resulting analytic techniques are called **Southern (DNA/DNA)** and **Northern (RNA–DNA) blotting**, respectively. These procedures allow for very distinct, high-sensitivity identification of specific nucleic acid species from complex mixtures of DNA or RNA (see [Chapter 39](#)).

There Are Grooves in the DNA Molecule

Examination of the model depicted in [Figure 34–2](#) reveals a **major groove** and a **minor groove** winding along the molecule parallel to the phosphodiester backbones. In these grooves, proteins often interact specifically with exposed atoms of the nucleotides (via specific hydrophobic and ionic interactions), thereby recognizing and binding to specific nucleotide sequences as well as the unique shapes formed therefrom. Binding usually occurs without disrupting the base pairing of the double-helical DNA molecule. As discussed in [Chapters 35, 36, and 38](#), regulatory proteins that control DNA replication, repair, and recombination as well as the transcription of specific genes occur through such protein-DNA interactions.

DNA Exists in Relaxed & Supercoiled Forms

In some organisms such as bacteria, bacteriophages, many DNA-containing animal viruses, as well as organelles such as mitochondria (see [Figure 35–8](#)), the ends of the DNA molecules are joined to create a closed circle with no covalently free ends. This of course does not destroy the polarity of the molecules, but it eliminates all free 3' and 5' hydroxyl and phosphoryl groups. Closed circles exist in relaxed or supercoiled forms. Supercoils are introduced when a closed circle is twisted around its own axis or when a linear piece of duplex DNA, whose ends are fixed, is twisted. This energy-requiring process puts the molecule under torsional stress, and the greater the number of supercoils, the greater the stress or torsion (test this by twisting a rubber band). **Negative supercoils** are formed when the molecule is twisted in the direction opposite from the clockwise turns of the right-handed double helix found in B-DNA. Such DNA is said to be underwound. The energy required to achieve this state is, in a sense, stored in the supercoils. The transition to another form that requires energy is thereby facilitated by the underwinding (see [Figure 35–19](#)). One such transition is strand separation, which is a prerequisite for DNA replication and transcription. Supercoiled DNA is therefore a preferred form in biologic systems. Enzymes that catalyze topologic changes of DNA are called **topoisomerases**. Topoisomerases can relax or insert supercoils, using ATP as an energy source. Homologs of this enzyme exist in all organisms and are important targets for cancer chemotherapy. Supercoils can also form within linear DNAs if particular segments of DNA are constrained by interacting tightly with nuclear proteins that establish two boundary sites defining a topologic domain.

DNA PROVIDES A TEMPLATE FOR REPLICATION & TRANSCRIPTION

The genetic information stored in the nucleotide sequence of DNA serves two purposes. It is the source of information for the synthesis of all protein molecules of the cell and organism, and it provides the information inherited by daughter cells or offspring. Both of these functions require that the DNA molecule serve as a template—in the first case for the transcription of the information into RNA and in the second case for the replication of the information into daughter DNA molecules.

When each strand of the double-stranded parental DNA molecule separates from its complement during replication, each independently serves as a template on which a new complementary strand is synthesized (**Figure 34–4**). The two newly formed double-stranded daughter DNA molecules, each containing one strand (but complementary rather than identical) from the parent double-stranded DNA molecule, are then sorted between the two daughter cells during mitosis (**Figure 34–5**). Each daughter cell contains DNA molecules with information identical to that which the parent possessed; yet, in each daughter cell, the DNA molecule of the parent cell has been only semiconserved.

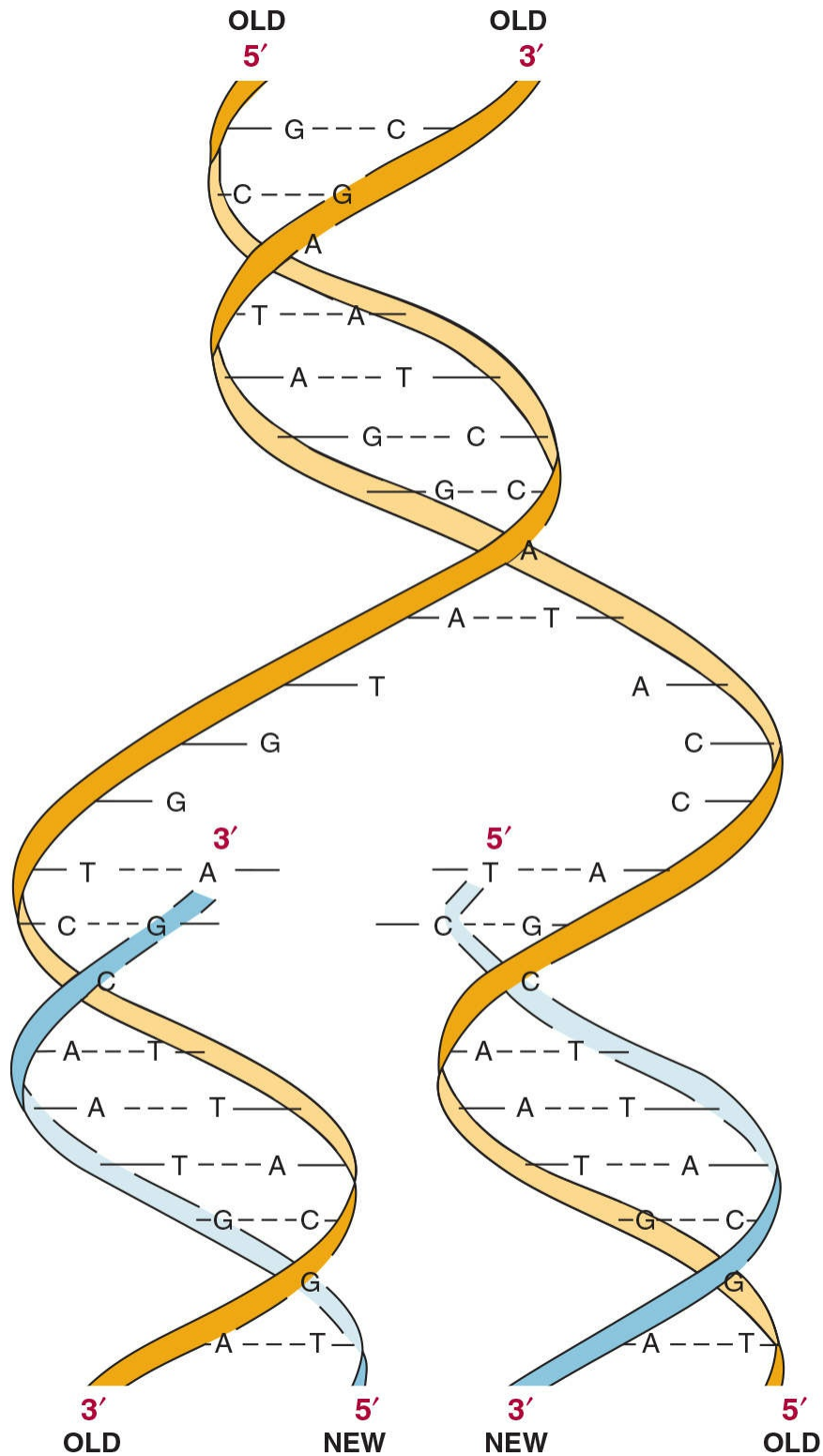

FIGURE 34-4 DNA synthesis maintains the sequence and structure of the original template DNA. The double-stranded structure of DNA and the template function of each old parental strand (orange) on which a new complementary daughter strand (blue) is synthesized.

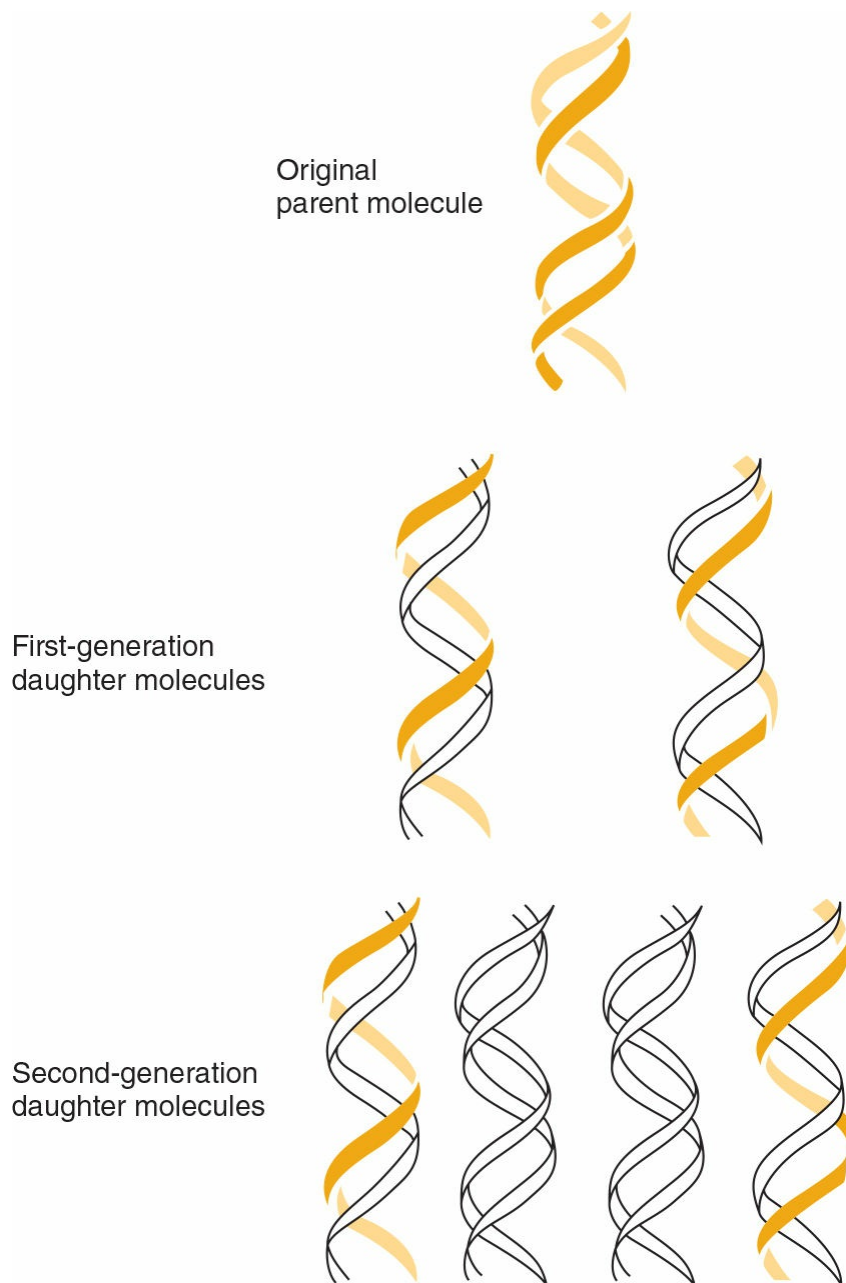

FIGURE 34–5 DNA replication is semiconservative. During a round of replication, each of the two strands of DNA is used as a template for synthesis of a new, complementary strand. The semiconservative nature of DNA replication has implications for the biochemical (see [Figure 35–16](#)), cytogenetic (see [Figure 35–2](#)), and epigenetic control of gene expression (see [Figures 38–8](#) and [38–9](#)).

THE CHEMICAL NATURE OF RNA DIFFERS FROM THAT OF DNA

RNA is a polymer of purine and pyrimidine ribonucleotides linked

together by 3',5'-phosphodiester bonds analogous to those in DNA (**Figure 34–6**). Although sharing many features with DNA, RNA possesses several specific differences:

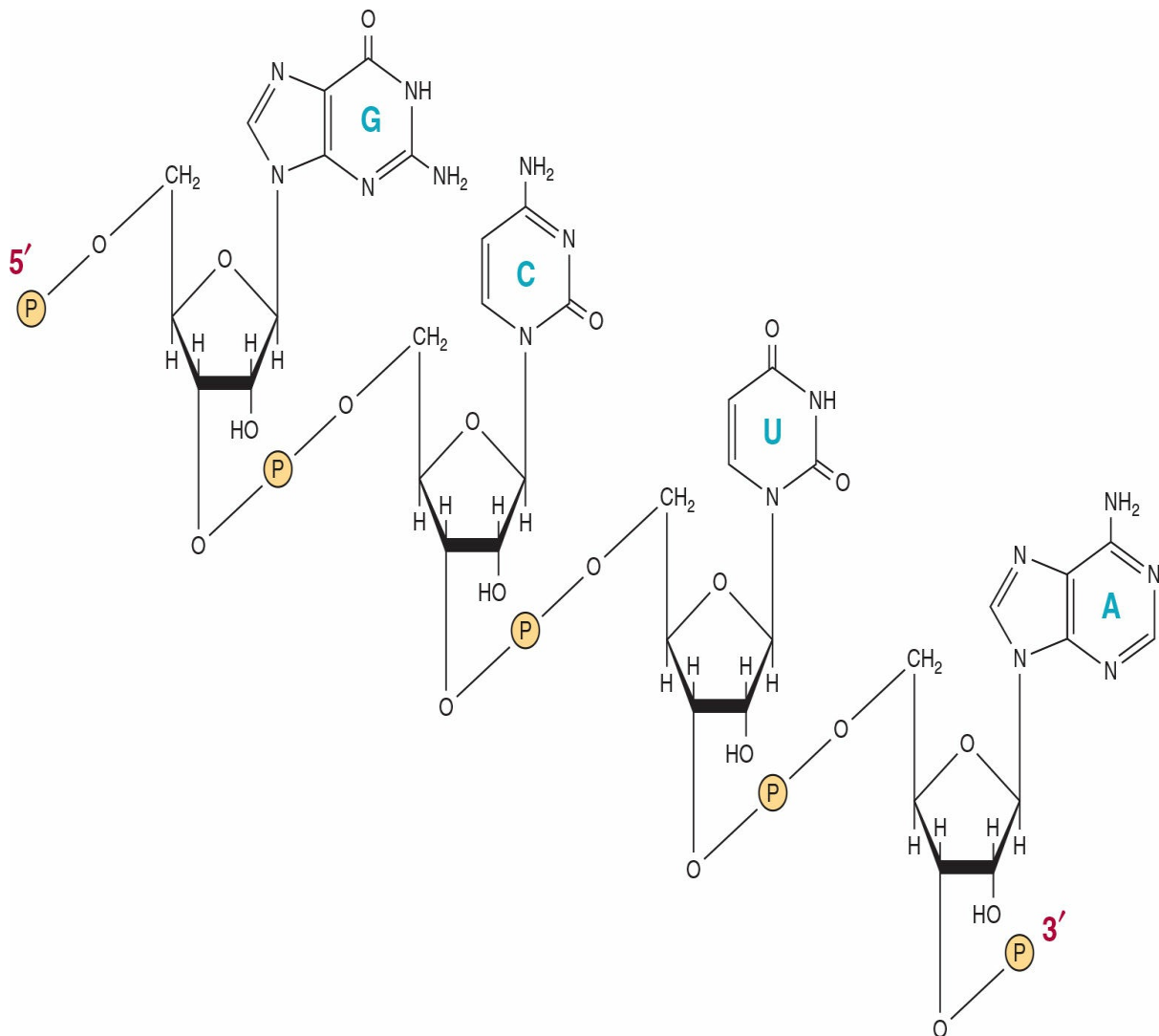

FIGURE 34–6 A segment of a ribonucleic acid (RNA) molecule in which the purine and pyrimidine bases—guanine (G), cytosine (C), uracil (U), and adenine (A)—are held together by phosphodiester bonds between ribosyl moieties attached to the nucleobases by *N*-glycosidic bonds. Note that negative charge(s) on the phosphodiester backbone are not illustrated (ie, **Figure 34–1**) and that the polymer has a polarity as indicated by the labeled 3'- and 5'-attached phosphates.

1. In RNA, the sugar moiety to which the phosphates and purine and pyrimidine bases are attached is ribose rather than the 2'-deoxyribose of DNA (see **Figures 19–2** and **32–3**).
2. The pyrimidine components of RNA can differ from those of DNA.

Although RNA contains the ribonucleotides of adenine, guanine, and cytosine, it does not possess thymine except in the rare case mentioned below. Instead of thymine, RNA contains the ribonucleotide of uracil.

3. RNA typically exists as a single strand, whereas DNA exists as a double-stranded helical molecule. However, given the proper complementary base sequence with opposite polarity, the single strand of RNA—as demonstrated in **Figures 34–7** and **34–11**—is capable of folding back on itself like a hairpin and thus acquiring double-stranded characteristics: G pairing with C, and A pairing with U.

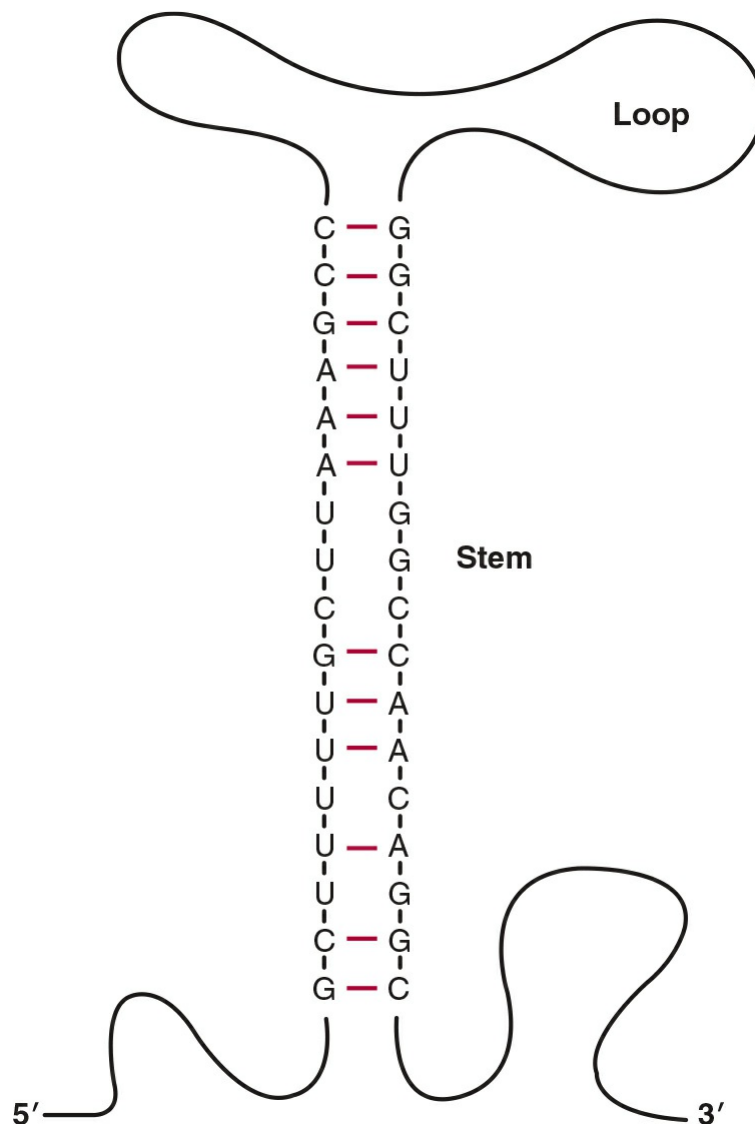

FIGURE 34–7 Diagrammatic representation of the secondary structure of a single-stranded RNA molecule in which a stem loop, or “hairpin,” has been formed. Formation of this structure is dependent on the indicated intramolecular base pairing (colored horizontal lines between bases). Note that G pairs with C as in DNA, but in RNA A pairs with U

via hydrogen bonds.

4. Since the RNA molecule is a single strand complementary to only one of the two strands of a gene, its guanine content does not necessarily equal its cytosine content, nor does its adenine content necessarily equal its uracil content.
5. RNA can be hydrolyzed by alkali to 2', 3' cyclic diesters of the mononucleotides, compounds that cannot be formed from alkali-treated DNA because of the absence of a 2'-hydroxyl group. The alkali lability of RNA is useful both diagnostically and analytically.

Information within the single strand of RNA is contained in its sequence ("primary structure") of purine and pyrimidine nucleotides within the polymer. The sequence is complementary to the template strand of the gene from which it was transcribed. Because of this complementarity, an RNA molecule can bind specifically via the base-pairing rules to its template DNA strand (**A**-T, **G**-C, **C**-G, **U**-A; RNA base bolded); it will not bind ("hybridize") with the other (coding) strand of its gene. The sequence of the RNA molecule (except for U replacing T) is the same as that of the coding strand of the gene (**Figure 34-8**).

DNA strands:

```
Coding → 5'—TGG AATTGTGAGCGGATAACAATTTACACAGGAAACAGCTATGACCATG—3'
Template → 3'—ACCTTAACACTCGCCTATTGTTAAAGTGTGTCTTTGTCGATACTGGTAC—5'
```

RNA transcript: 5'—**ppp AUUGUGAGCGGAUAACAAUUUCACACAGGAAACAGCUAUGACCAUG** 3'

FIGURE 34-8 The relationship between the sequences of an RNA transcript and its gene, in which the coding and template strands are shown with their polarities. The RNA transcript with a 5' to 3' polarity is complementary to the template strand with its 3' to 5' polarity. Note that the sequence in the RNA transcript and its polarity is the same as that in the coding strand, except that the U of the transcript replaces the T of the gene; the initiating nucleotide of RNAs contain a terminal 5-triphosphate (ie, pppA-above).

NEARLY ALL THE SEVERAL SPECIES OF STABLE, ABUNDANT RNAs ARE INVOLVED IN SOME ASPECT OF PROTEIN SYNTHESIS

Those cytoplasmic RNA molecules that serve as templates for protein

synthesis (ie, that transfer genetic information from DNA to the protein-synthesizing machinery) are designated **messenger RNAs (mRNAs)**. Many other very abundant cytoplasmic RNA molecules (**ribosomal RNAs [rRNAs]**) have structural roles wherein they contribute to the formation and function of ribosomes (the organellar machinery for protein synthesis) or serve as adapter molecules (**transfer RNAs [tRNAs]**) for the translation of RNA information into specific sequences of polymerized amino acids.

Interestingly, some RNA molecules have intrinsic catalytic activity. The activity of these RNA enzymes, or **ribozymes**, often involves the cleavage of a nucleic acid. Two ribozymes are the peptidyl transferase that catalyzes peptide bond formation on the ribosome, and ribozymes involved in the RNA splicing.

In all eukaryotic cells, there are **small nuclear RNA (snRNA)** species that are not directly involved in protein synthesis but play pivotal roles in RNA processing, particularly mRNA processing. These relatively small molecules vary in size from 90 to about 300 nucleotides (**Table 34–1**). The properties of the several classes of cellular RNAs are detailed below.

TABLE 34–1 Some of the Species of Small-Stable RNAs Found in Mammalian Cells

Name	Length (nucleotides)	Molecules per Cell	Localization
U1	165	1×10^6	Nucleoplasm
U2	188	5×10^5	Nucleoplasm
U3	216	3×10^5	Nucleolus
U4	139	1×10^5	Nucleoplasm
U5	118	2×10^5	Nucleoplasm
U6	106	3×10^5	Perichromatin granules
4.5S	95	3×10^5	Nucleus and cytoplasm
7SK	280	5×10^5	Nucleus and cytoplasm

The genetic material for some animal and plant viruses is RNA rather than DNA. Although some RNA viruses never have their information transcribed into a DNA molecule, many animal RNA viruses—specifically, the retroviruses (eg, the human immunodeficiency, or HIV virus)—are transcribed by **viral RNA–dependent DNA polymerase, the**

so-called reverse transcriptase, to produce a double-stranded DNA copy of their RNA genome. In many cases, the resulting double-stranded DNA transcript is integrated into the host genome and subsequently serves as a template for gene expression and from which new viral RNA genomes and viral mRNAs can be transcribed. Genomic insertion of such integrating “proviral” DNA molecules can, depending on the site involved, be mutagenic, inactivating a gene or disregulating its expression (see [Figure 35–11](#)).

THERE EXIST SEVERAL DISTINCT CLASSES OF RNA

As noted above, in all prokaryotic and eukaryotic organisms, four main classes of RNA molecules exist: mRNA, tRNA, rRNA, and small RNAs. Each differs from the others by abundance, size, function, and general stability.

Messenger RNA

This class is the most heterogeneous in abundance, size, and stability; for example, in brewer’s yeast, specific mRNAs are present in 100s/cell to, on average, ≤ 0.1 /mRNA/cell in a genetically homogeneous population. As detailed in [Chapters 36](#) and [38](#), both specific transcriptional and posttranscriptional mechanisms contribute to this large dynamic range in mRNA content. In mammalian cells, specific mRNA abundance likely varies over a 10^4 -fold range. All members of this RNA class function as messengers conveying the information in a gene to the protein-synthesizing machinery, where each mRNA serves as a template on which a specific sequence of amino acids is polymerized to form a specific protein molecule, the ultimate gene product ([Figure 34–9](#)).

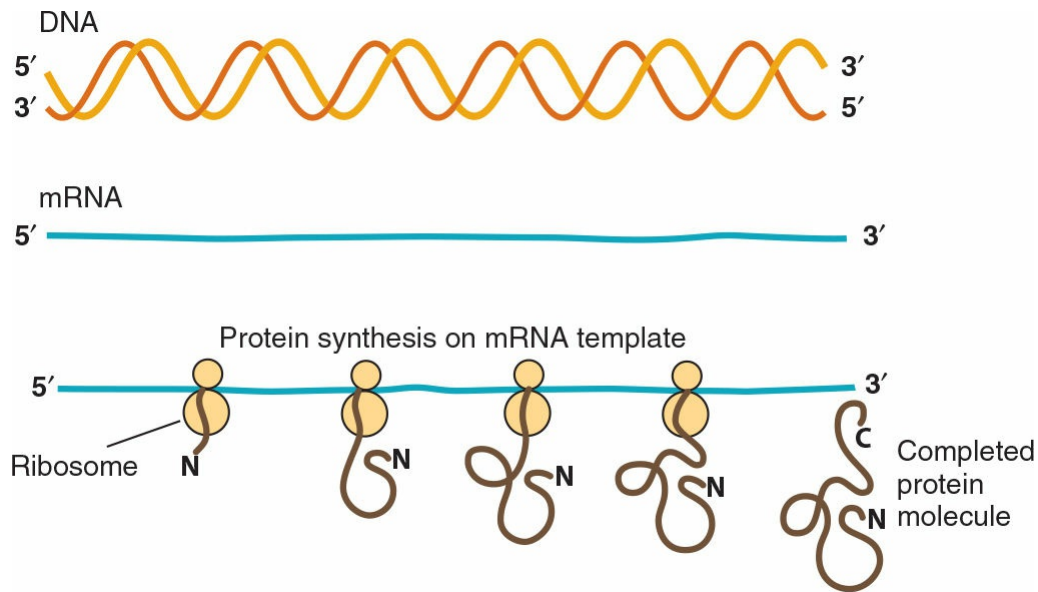

FIGURE 34–9 The expression of genetic information within DNA into the form of an mRNA transcript with 5' to 3' polarity and then into protein with N- to C-polarity is shown. DNA is transcribed into mRNA that is subsequently translated by ribosomes into a specific protein molecule that exhibits polarity, N-terminus (N) to C-terminus (C).

Eukaryotic mRNAs have unique chemical characteristics. The 5' terminus of mRNA is “capped” by a 7-methylguanosine triphosphate that is linked to an adjacent 2'-*O*-methyl ribonucleoside at its 5'-hydroxyl through the three phosphates (**Figure 34–10**). The mRNA molecules frequently contain internal 6-methyladenine and other 2'-*O*-ribose-methylated nucleotides. The cap is involved in the recognition of mRNA by the translation machinery, and also helps stabilize the mRNA by preventing the nucleolytic attack by 5'-exoribonucleases. The protein-synthesizing machinery begins translating the mRNA into proteins beginning downstream of the 5' or capped terminus. At the other end of almost all eukaryotic mRNA molecules, the 3'-hydroxyl terminus has an attached, nongenetically encoded polymer of adenylate residues 20 to 250 nucleotides in length. The poly(A) “tail” at the 3'-end of mRNAs maintains the intracellular stability of the specific mRNA by preventing the attack of 3'-exoribonucleases and also facilitates translation (see **Figure 37–7**). Both the mRNA “cap” and “poly(A) tail” are added posttranscriptionally by nontemplate-directed enzymes to mRNA precursor molecules (pre-mRNA). mRNA represents 2 to 5% of total eukaryotic cellular RNA.

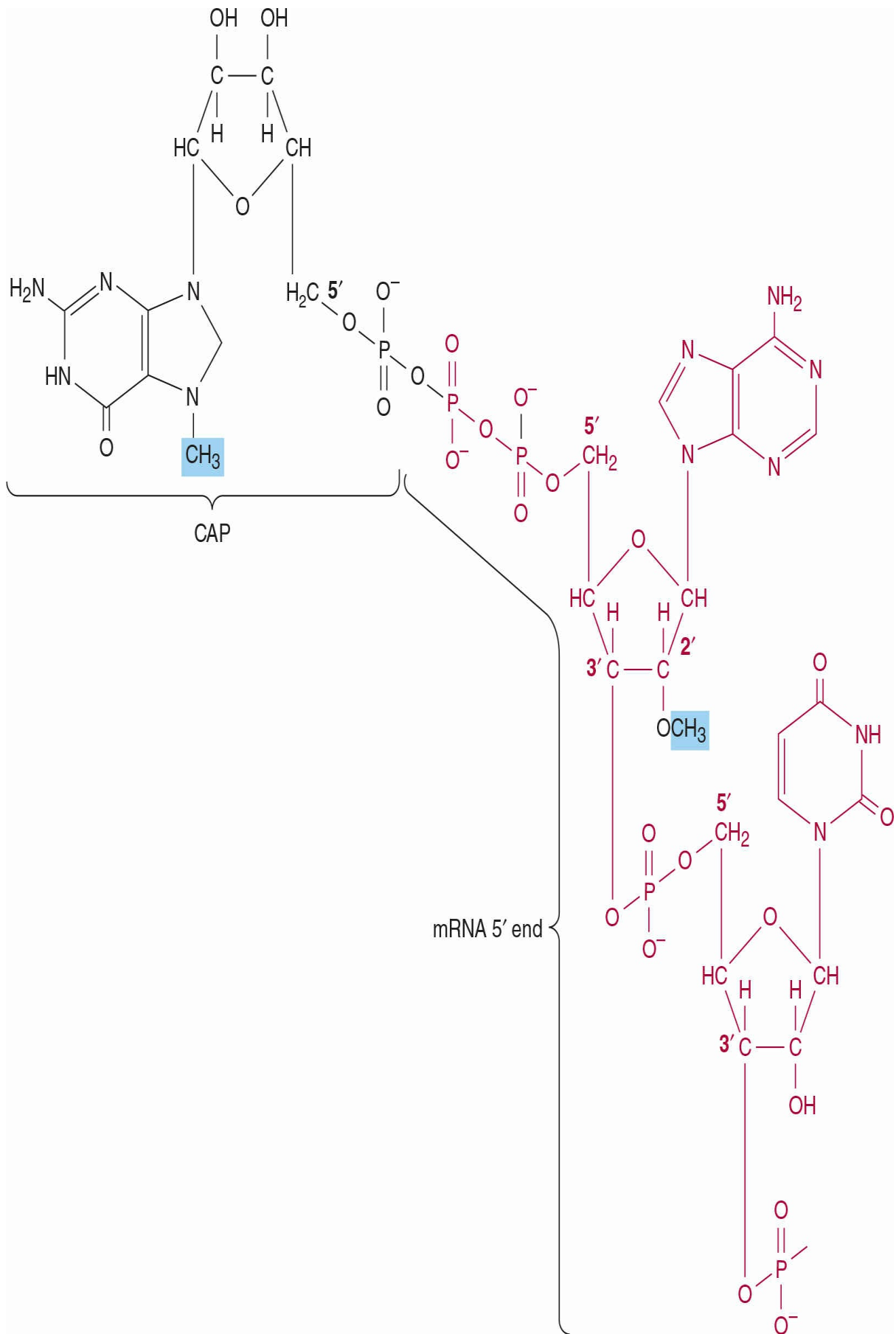

FIGURE 34–10 The cap structure attached to the 5' terminal of most eukaryotic messenger RNA molecules. A 7-methylguanosine triphosphate (black) is attached at the 5' end of the mRNA (red), which usually also contains a 2'-*O*-methylpurine nucleotide. These modifications (the cap and methyl group) are added after the mRNA is transcribed from DNA. Note that the γ - and β -phosphates of the GTP added to form the cap (black in figure) are lost upon cap addition while the γ -phosphate of the initiating nucleotide (here an A-residue; red in figure) is lost during cap addition.

In mammalian cells, including cells of humans, the mRNA molecules present in the cytoplasm are not the RNA products immediately synthesized from the DNA template but must be formed by processing from the precursor, or pre-mRNA before entering the cytoplasm. Thus, in mammalian cell nuclei, the immediate products of gene transcription (primary transcripts) are very heterogeneous and can be greater than 10- to 50-fold longer than mature mRNA molecules. As discussed in [Chapter 36](#), pre-mRNA molecules are processed to generate mRNA molecules, which then enter the cytoplasm to serve as templates for protein synthesis.

Transfer RNA

tRNA molecules vary in length from 74 to 95 nucleotides, like many other RNAs, are also generated by nuclear processing of a precursor molecule (see [Chapter 36](#)). The tRNA molecules serve as adapters for the translation of the information in the sequence of nucleotides of the mRNA into specific amino acids. There are at least 20 species of tRNA molecules in every cell, at least one (and often several) corresponding to each of the 20 amino acids required for protein synthesis. Although each specific tRNA differs from the others in its sequence of nucleotides, the tRNA molecules as a class have many features in common. The primary structure—that is, the nucleotide sequence—of all tRNA molecules allows extensive folding and intrastrand complementarity to generate a secondary structure that appears in two dimensions like a cloverleaf ([Figure 34–11](#)).

Primary Structure (1°)

5' pGCGGAUUUAGCUCAGUUGGGAGAGCGCCAGACUGAAGAUCUGGAGGUCCUGUGUUCGAUCCACAGAAUUCGCACCA_{OH} 3'

10 20 30 40 50 60 70

Secondary Structure (2°)

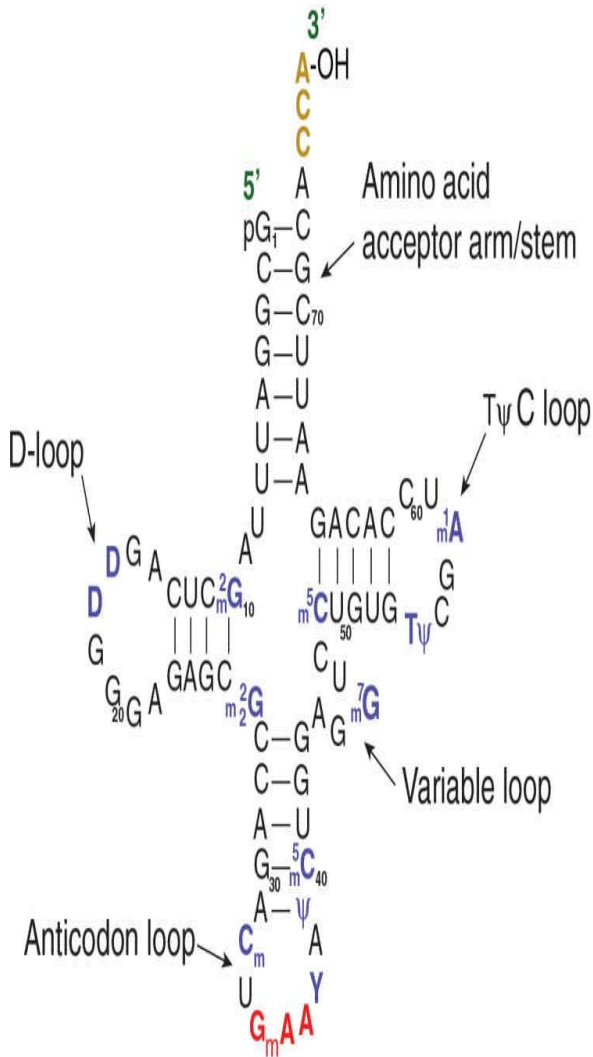

Tertiary Structure (3°)

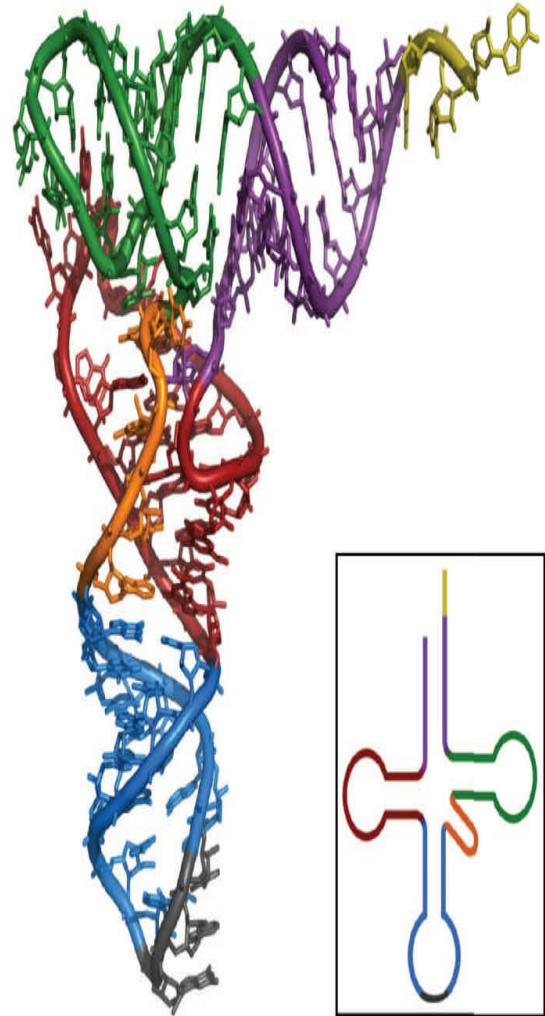

FIGURE 34–11 Structure of a mature, functional tRNA, yeast phenylalanyl-tRNA (tRNA^{Phe}). Shown are primary (1°), secondary (2°), and tertiary (3°) structures (top, lower left, and lower right, respectively) of tRNA^{Phe}. Numerals below the 76 nucleotide-long tRNA^{Phe} primary structure indicate nucleotide numbering from the 5' (+1) to the 3' end (+76) of the molecule. Note that the +1 nucleotide contains a 5' phosphate moiety (P), while the 3' nucleotide has a free 3' hydroxyl group (OH). Bases underlined in bold type within the sequence of tRNA^{Phe} are heavily

modified to the nucleotides shown in the 2^o structural representation of tRNA^{Phe}. This structure is often referred to as a “cloverleaf.” Some of these nucleotides have noncanonical ribonucleotide names, as represented in the 2^o structural model. Within tRNA^{Phe} nucleotides U₁₆ and U₁₇ are modified to D₁₆, D₁₇; G₃₇ to Y₃₇; U₃₉ and U₅₅ to Ψ; and U₅₄ to T₅₄ (see text below for details). Straight lines between bases within the tRNA secondary structure represent hydrogen bonds formed between bases (A–U; G–C). Note that these regions of secondary structure form with the same strand polarity (ie, 5' to 3' and 3' to 5') as base-paired regions of DNA. The three bases of the anticodon loop are shown in red. In the case of amino acid–charged tRNAs, an aminoacyl moiety is esterified to the 3'-CCA_{OH} terminus (brown; in this case the amino acid would be phenylalanine; not shown). Blue type highlights nontraditional nucleotides introduced by posttranslational modification, abbreviated as follows: m²G = 2-methylguanosine; D = 5,6-dihydrouridine; m²₂G = N2-dimethylguanosine; C_m = O2'-methylcytidine; G_m = O2'-methylguanosine; T = 5-methyluridine; Y = wybutosine; Ψ = pseudouridine; m⁵C = 5-methylcytidine; m⁷G = 7-methylguanosine; m¹A = 1-methyladenosine. Essentially all tRNAs fold into similar, characteristic, tertiary structures (3^o) as shown, lower right. The distinct portions of the molecule in 2^o (insert) and 3^o configurations are color-coded in this image for clarity. tRNA^{Phe} was the first nucleic acid whose structure was determined by x-ray crystallography. Such distinct three-dimensional tRNA structures bind specifically to important functional sites on both aminoacyl tRNA synthetases and the ribosomes during protein synthesis (see [Chapter 37](#)). The tRNA^{Phe} secondary and tertiary structure images are open source figures from Wikipedia (wikimedia.org/wikipedia/commons/b/ba/TRNA-Phe_yeast_1ehz.png).

All tRNA molecules contain four main double-stranded arms or stems, connected by single-stranded loops named for their respective nucleotide composition or function. The **acceptor arm** terminates in the nucleotides CpCpA_{OH}. These three nucleotides are added posttranscriptionally by a specific nucleotidyl transferase enzyme. The tRNA-appropriate amino acid is attached, or “charged,” onto the 3'-OH group of the A moiety of the acceptor arm through the action of specific aminoacyl tRNA synthetases (see [Figure 37–1](#)). The **D**, **TΨC**, and **extra arms** help define a specific

tRNA. tRNAs compose roughly 20% of total cellular RNA.

Ribosomal RNA

A ribosome is a cytoplasmic nucleoprotein structure that acts as the machinery for the synthesis of proteins from the mRNA templates. On the ribosomes, the mRNA and tRNA molecules interact to translate the information transcribed from the gene during mRNA synthesis into a specific protein. During periods of active protein synthesis, many ribosomes can be associated with any mRNA molecule to form an assembly called the **polysome** (see [Figure 37–7](#)).

The components of the mammalian ribosome, which has a molecular weight of about 4.2×10^6 and a sedimentation velocity coefficient of 80S (**S = Svedberg units**, a parameter sensitive to molecular size and shape) are shown in [Table 34–2](#). The mammalian ribosome contains two major nucleoprotein subunits—a larger one with a molecular weight of 2.8×10^6 (60S) and a smaller subunit with a molecular weight of 1.4×10^6 (40S). The 60S subunit contains a 5S rRNA, a 5.8S rRNA, and a 28S rRNA; there are also more than 50 specific polypeptides. The 40S subunit is smaller and contains a single 18S rRNA and approximately 30 distinct polypeptide chains. All of the rRNA molecules except the 5S rRNA, which is independently transcribed, are processed from a single 45S precursor RNA molecule in the nucleolus (see [Chapter 36](#)). The highly methylated rRNA molecules are packaged in the nucleolus with the specific ribosomal proteins. In the cytoplasm, the ribosomes remain quite stable and capable of many translation cycles. The exact functions of the rRNA molecules in the ribosomal particle are not fully understood, but they are necessary for ribosomal assembly and also play key roles in the binding of mRNA to ribosomes and its translation. Recent studies indicate that the large rRNA component performs the peptidyl transferase activity and thus is a ribozyme. The rRNAs (28S + 18S) represent roughly 70% of total cellular RNA.

TABLE 34–2 Components of Mammalian Ribosomes

Component	Mass (MW)	Protein		RNA		
		Number	Mass	Size	Mass	Bases
40S subunit	1.4×10^6	33	7×10^5	18S	7×10^5	1900
60S subunit	2.8×10^6	50	1×10^6	5S	3.5×10^4	120
				5.8S	4.5×10^4	160
				23S	1.6×10^6	4700

Note: The ribosomal subunits are defined according to their sedimentation velocity in Svedberg (S) units (40S or 60S). The number of unique proteins and their total mass (MW) and the RNA components of each subunit in size (Svedberg units), mass, and number of bases are listed.

Small RNA

A large number of discrete, highly conserved small RNA species are found in eukaryotic cells; some are quite stable. Most of these molecules are complexed with proteins to form ribonucleoproteins and are distributed in the nucleus, the cytoplasm, or both. They range in size from 20 to 1000 nucleotides and are present in 100,000 to 1,000,000 copies per cell, collectively representing $\leq 5\%$ of cellular RNA.

Small Nuclear RNAs

snRNAs, a subset of the small nuclear RNAs (Table 34–1), are significantly involved in rRNA and mRNA processing and gene regulation. Of the several snRNAs, U1, U2, U4, U5, and U6 are involved in intron removal and the processing of mRNA precursors into mRNA within the nucleus (see Chapter 36). The U7 snRNA is involved in production of the correct 3' ends of histone mRNA—which lacks a poly(A) tail. 7SK RNA associates with several proteins to form a ribonucleoprotein complex, termed P-TEFb, that modulates mRNA gene transcription elongation by RNA polymerase II (see Chapter 36).

Large & Small Noncoding Regulatory RNAs: Micro-RNAs (miRNAs), Silencing RNAs (siRNAs), Long Noncoding RNAs (lncRNAs), and Circular RNAs (circRNAs)

One of the most exciting and unanticipated discoveries in the last decade of eukaryotic regulatory biology has been the identification and characterization of regulatory nonprotein coding RNAs (ncRNAs). NcRNAs exist in two general size classes, large (50-1000nt) and small

(20–22nt). Regulatory ncRNAs have been described in most eukaryotes (see [Chapter 38](#)).

The **small ncRNAs termed miRNAs and siRNAs typically inhibit gene expression** at the level of specific protein production by targeting mRNAs through one of several distinct mechanisms. miRNAs are generated by specific nucleolytic processing of the products of distinct genes/transcription units (see [Figure 36–17](#)). miRNA precursors, which are 5'-capped and 3'-polyadenylated, usually range in size from about 500 to 1000 nucleotides.

By contrast, siRNAs are generated by the specific nucleolytic processing of large dsRNAs that are either produced from other endogenous RNAs, or dsRNAs introduced into the cell by, for example, RNA viruses. Both **siRNAs and miRNAs hybridize via the formation of RNA–RNA hybridization to their targeted mRNAs** (see [Figure 38–19](#)). To date, hundreds of distinct miRNAs and siRNAs have been described in humans; estimates suggest that there are ~1000 human miRNA-encoding genes. Given their exquisite genetic specificity both miRNAs and siRNAs represent exciting new **potential agents for therapeutic drug development**. siRNAs are frequently used to decrease or “knockdown” specific protein levels (via siRNA homology-directed mRNA degradation) in experimental contexts in the laboratory, an extremely useful and powerful alternative to gene-knockout technology (see [Chapter 39](#)). Indeed, several siRNA-based therapeutic clinical trials are in progress to test the efficacy of these novel molecules as drugs for treating human disease.

Other exciting recent observations in the RNA realm are the identification and characterization of two classes of larger noncoding RNAs, the **circular RNAs (circRNAs)** and the **long noncoding RNAs, or lncRNAs**. Many **circRNAs** have recently been discovered and characterized. circRNAs appear to be produced by RNA splicing-type reactions from a wide range of precursor RNAs, both mRNA precursors and nonprotein lncRNA precursors (see below for more information on lncRNAs). Though not an abundant class of RNA molecules in most cells, circRNAs have been detected in all eukaryotes tested, particularly in metazoans. While the functions of circRNAs are still being elucidated they seem to be particularly abundant in cells of the nervous system. Similar to lncRNAs, these molecules likely play important roles in cellular biology by regulating gene expression at multiple levels. LncRNAs, which as their name implies, do not code for protein, and range in size from ~300 to 1000s of nucleotides in length. These RNAs are typically transcribed from

the large regions of eukaryotic genomes that do not encode for protein (ie, the mRNA encoding genes). In fact, transcriptome analyses indicate that **>90% of all eukaryotic genomic DNA is transcribed**. ncRNAs make up a significant portion of this transcription. ncRNAs play many roles ranging from contributing to structural aspects of chromatin to regulation of mRNA gene transcription by RNA polymerase II. Future work will further characterize this important, newly discovered class of RNA molecules.

Interestingly, bacteria also contain small, heterogeneous regulatory RNAs termed sRNAs. Bacterial sRNAs range in size from 50 to 500 nucleotides, and like eukaryotic mi/si/lncRNAs, also control a large array of genes. sRNAs often repress, but sometimes activate protein synthesis by binding to specific mRNA.

SPECIFIC NUCLEASES DIGEST NUCLEIC ACIDS

Enzymes capable of degrading nucleic acids have been recognized for many years. These nucleases can be classified in several ways. Those that exhibit specificity for DNA are referred to as **deoxyribonucleases**. Those nucleases that specifically hydrolyze RNA are **ribonucleases**. Some nucleases degrade both DNA and RNA. Within both of these classes are enzymes capable of cleaving internal phosphodiester bonds to produce either 3'-hydroxyl and 5'-phosphoryl terminals or 5'-hydroxyl and 3'-phosphoryl terminals. These are referred to as **endonucleases**. Some are capable of hydrolyzing both strands of a **double-stranded** molecule, whereas others can only cleave **single strands** of nucleic acids. Some nucleases can hydrolyze only unpaired single strands, while others are capable of hydrolyzing single strands participating in the formation of a double-stranded molecule. There exist classes of endonucleases that recognize specific sequences in DNA. One class of these DNA cleaving enzymes, the **restriction endonucleases**, also termed restriction enzymes, do so directly by binding contiguous DNA base pairs (typically 4, 5, 6, or 8 bp) and cleaving both strands of DNA, usually DNA within the binding/recognition sequence element. The second class of enzymes, which are ribonucleoprotein complexes, utilizes a “guide RNA” of specific nucleotide sequence that targets a nuclease to cleave distinct DNA or RNA sequences. These are the **CRISPR-Cas** family of enzymes. Both classes of DNA-cleaving enzyme are described in greater detail in [Chapter 39](#). These enzymes represent critically important tools in molecular genetics and medical sciences.

Some nucleases are capable of hydrolyzing a nucleotide only when it is present at a terminal of a molecule; these are referred to as **exonucleases**. Exonucleases act in one direction (3' → 5' or 5' → 3') only. In bacteria, a 3' → 5' exonuclease is an integral part of the DNA replication machinery and there serves to edit—or proofread—the most recently added deoxynucleotide for base-pairing errors.

SUMMARY

- DNA consists of four bases—A, G, C, and T—that are held in linear array by phosphodiester bonds through the 3' and 5' positions of adjacent deoxyribose moieties.
- DNA is organized into two strands by the pairing of bases A to T and G to C on complementary strands. These strands form a double helix around a central axis.
- The $\sim 3 \times 10^9$ bp of DNA in humans are organized into the haploid complement of 23 chromosomes. The exact sequence of these 3 billion nucleotides defines the uniqueness of each individual.
- DNA provides a template for its own replication and thus maintenance of the genotype and for the transcription of the roughly 25,000 protein coding human genes as well as a large array of nonprotein coding regulatory ncRNAs.
- RNA exists in several different single-stranded structures, most of which are directly or indirectly involved in protein synthesis or its regulation. The linear array of nucleotides in RNA consists of A, G, C, and U, and the sugar moiety is ribose.
- The major forms of RNA include mRNA, rRNA, tRNA, and snRNAs and regulatory ncRNAs. Certain RNA molecules act as catalysts (ribozymes).

REFERENCES

- Cech TR, Steitz JA: The noncoding RNA revolution—trashing old rules to forge new ones. *Cell* 2014;157:77.
- Mayerle M, Guthrie C: Genetics and biochemistry remain essential in the structural era of the spliceosome. *Methods* 2017;125:3.
- Muruhan K, Babu K, Sundaresan R, et al: The revolution continues: newly discovered systems expand the CRISPR-Cas toolkit. *Molecular Cell* 2017;68:15.
- Noller HF: The parable of the caveman and the Ferrari: protein synthesis

- and the RNA world. *Philos Trans R Soc Lond B Biol Sci* 2017;372(1716):20160187.
- Rich A, Zhang S: Timeline: Z-DNA: the long road to biological function. *Nat Rev Genet* 2003;4:566.
- Salzman J: Circular RNA expression: its potential regulation and function. *Trends Genet* 2016;32:309.
- Watson JD, Crick FH: Molecular structure of nucleic acids: a structure for deoxyribose nucleic acid. *Nature* 1953;171:737.

DNA Organization, Replication, & Repair

P. Anthony Weil, PhD

OBJECTIVES

After studying this chapter, you should be able to:

- Appreciate that the roughly 3×10^9 base pairs of DNA that compose the haploid genome of humans are divided uniquely between 23 linear DNA units, the chromosomes. Humans, being diploid, have 23 pairs of these linear chromosomes: 22 autosomes and two sex chromosomes.
- Understand that human genomic DNA, if extended end-to-end, would be meters in length, yet still fits within the nucleus of the cell, an organelle that is only microns (μ ; 10^{-6} meters) in diameter. Such condensation in DNA length, in part, is induced following its association with the highly positively charged histone proteins resulting in the formation of a unique DNA-histone complex termed the nucleosome. Nucleosomes have DNA wrapped around the surface of an octamer of histones.
- Explain that strings of nucleosomes form along the linear sequence of genomic DNA to form chromatin, which itself can be more tightly packaged and condensed, this ultimately leads to the

formation of the chromosomes.

- Appreciate that while the chromosomes are the macroscopic functional units for DNA transcription, replication, recombination, gene assortment, and cellular division, it is DNA function at the level of the individual nucleotides that composes regulatory sequences linked to specific genes that are essential for life.
- Describe the steps, phase of the cell cycle, and the molecules responsible for the replication, repair, and recombination of DNA, and understand the negative effects that errors in any of these processes can have upon cellular and organismal integrity and health.

BIOMEDICAL IMPORTANCE*

The genetic information in the DNA of a chromosome can be transmitted by exact replication or it can be exchanged by a number of processes, including crossing over, recombination, transposition, and gene conversion. These processes provide a means of ensuring adaptability and diversity for the organism, but when they go awry, can also result in disease. A number of enzyme systems are involved in DNA replication, alteration, and repair. Mutations are due to a change in the base sequence of DNA and may result from the faulty replication, transposition, or repair of DNA and occur with a frequency of about one in every 10^6 cell divisions. Abnormalities in gene products (either in RNA, protein function, or amount) can be the result of mutations that occur in transcribed protein coding, and nonprotein coding DNA, or nontranscribed regulatory-region DNA. A mutation in a germ cell is transmitted to offspring (so-called vertical transmission of hereditary disease). A number of factors, including viruses, chemicals, ultraviolet light, and ionizing radiation, increase the rate of mutation. Mutations often affect somatic cells and so are passed on to successive generations of cells, but only within an organism (ie, horizontally). It is becoming apparent that a number of diseases—and perhaps most cancers—are due to the combined effects of vertical transmission of mutations as well as horizontal transmission of induced mutations.

CHROMATIN IS THE CHROMOSOMAL MATERIAL IN THE NUCLEI OF CELLS OF

EUKARYOTIC ORGANISMS

Chromatin consists of very long **double-stranded DNA (dsDNA) molecules** and a nearly equal mass of small basic proteins termed **histones** as well as a smaller amount of **nonhistone proteins** (most of which are acidic and larger than histones) and a small quantity of **RNA**. The nonhistone proteins include enzymes involved in DNA replication and repair, and the proteins involved in RNA synthesis, processing, and transport to the cytoplasm. The dsDNA helix in each chromosome has a length that is thousands of times the diameter of the cell nucleus. One purpose of the molecules that comprise chromatin, particularly the histones, is to condense the DNA; however, it is important to note that the histones also integrally participate in gene regulation ([Chapters 36, 38, and 42](#)); indeed, histones contribute importantly to all DNA-directed molecular transactions. Electron microscopic studies of chromatin have demonstrated dense spherical particles called **nucleosomes**, which are approximately 10 nm in diameter and connected by DNA filaments ([Figure 35–1](#)). Nucleosomes are composed of DNA wound around an octameric complex of histone molecules.

Histones Are the Most Abundant Chromatin Proteins

Histones are a small family of closely related basic proteins. **H1 histones** are the ones least tightly bound to chromatin ([Figures 35–1, 35–2, and 35–3](#)) and are, therefore, easily removed with a salt solution, after which chromatin becomes more soluble. The organizational unit of this soluble chromatin is the nucleosome. **Nucleosomes contain four major types of histones: H2A, H2B, H3, and H4**. The sequence and structures of all four histones, H2A, H2B, H3, and H4, the so-called core histones that form the nucleosome, have been highly conserved between species, although variants of the histones exist and are used for specialized purposes. This extreme conservation implies that the function of histones is identical in all eukaryotes and that the entire molecule is involved quite specifically in carrying out this function. The carboxyl terminal two-thirds of the histone molecules are hydrophobic, while their amino terminal thirds are particularly rich in basic amino acids. **These four core histones are subject to at least six types of covalent modification or posttranslational modifications (PTMs): acetylation, methylation, phosphorylation, ADP-ribosylation, monoubiquitylation, and sumoylation**. These histone modifications play important roles in chromatin structure and function, as illustrated in [Table 35–1](#).

TABLE 35–1 Possible Roles of Posttranslationally Modified Histones

1. Acetylation of histones H3 and H4 is associated with the activation or inactivation of gene transcription.
2. Acetylation of core histones is associated with chromosomal assembly during DNA replication.
3. Phosphorylation of histone H1 is associated with the condensation of chromosomes during the replication cycle.
4. ADP-ribosylation of histones is associated with DNA repair.
5. Methylation of histones is correlated with activation and repression of gene transcription.
6. Monoubiquitylation is associated with gene activation, repression, and heterochromatic gene silencing.
7. Sumoylation of histones (SUMO; small ubiquitin-related modifier) is associated with transcription repression.

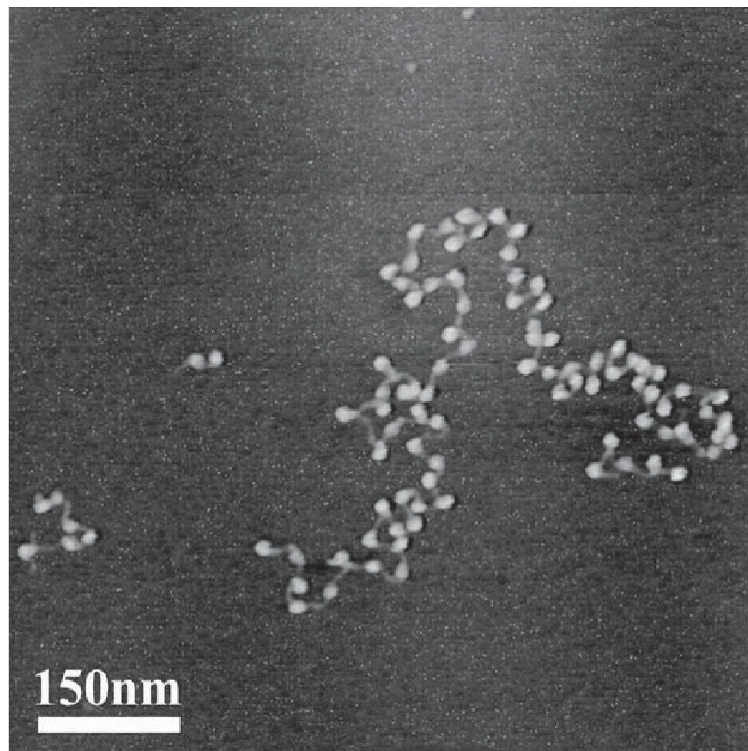

FIGURE 35–1 Electron micrograph of chromatin showing individual nucleosomes (white, ball-shaped) attached to strands of DNA (thin, gray line); see also [Figure 35–2](#). (Reproduced, with permission, from Shao Z: Probing nanometer structures with atomic force microscopy. *News Physiol Sci* 1999;14:142–149. Courtesy of Professor Zhifeng Shao, University of Virginia.)

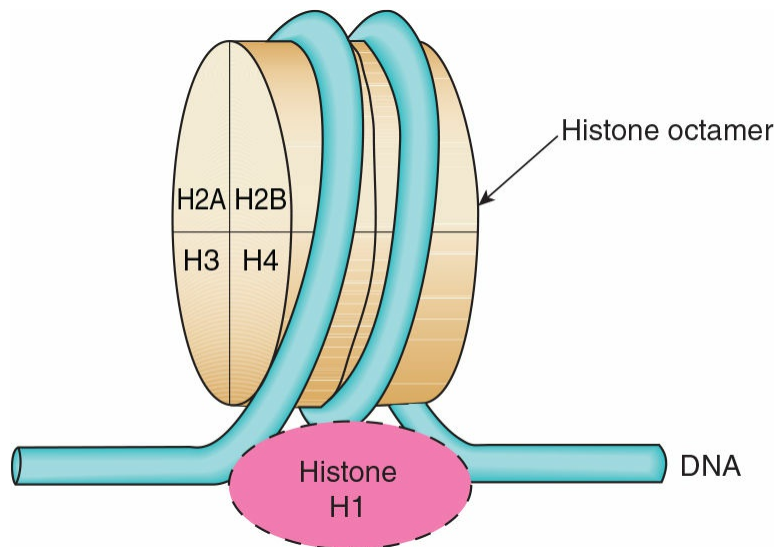

FIGURE 35–2 Model for the structure of the nucleosome. DNA is wrapped around the surface of a protein cylinder consisting of two each of histones H2A, H2B, H3, and H4 that form the histone octamer. The ~145 bp of DNA, consisting of 1.75 superhelical turns, are in contact with the histone octamer. The position of histone H1, when it is present, is indicated by the dashed outline at the bottom of the figure. Note that histone H1 interacts with DNA as it enters and exits the nucleosome.

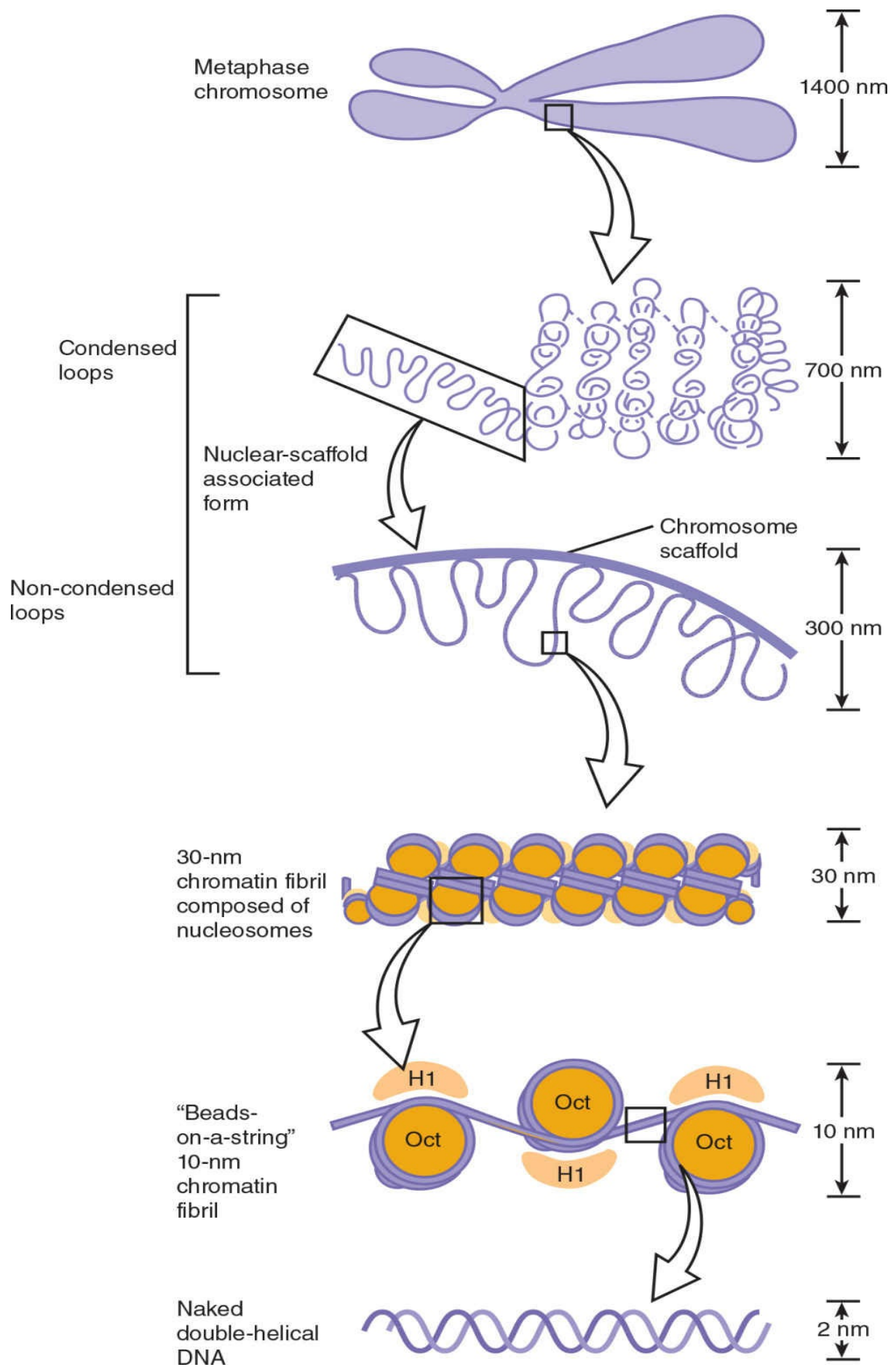

FIGURE 35–3 Extent of DNA packaging in metaphase chromosomes (top) to naked duplex DNA (bottom). Chromosomal DNA is packaged and organized at several levels as shown (see [Table 35–2](#)). Each phase of condensation or compaction and organization (bottom to top) decreases overall DNA accessibility to an extent that the DNA sequences in metaphase chromosomes are likely almost totally transcriptionally inert. In toto, these five levels of DNA compaction result in nearly a 10^4 -fold linear decrease in end-to-end DNA length. Complete condensation and decondensation of the linear DNA in chromosomes occur in the space of hours during the normal replicative cell cycle (see [Figure 35–20](#)).

TABLE 35–2 The Packing or Compaction Ratios of Each of the Orders of DNA Structure

Chromatin Form	Packing Ratio
Naked double-helical DNA	~1.0
10-nm fibril of nucleosomes	7-10
30-nm chromatin fiber of superhelical nucleosomes	40-60
Condensed metaphase chromosome loops	8000

The histones interact with each other in very specific ways. **H3 and H4 form a tetramer** containing two molecules of each $(H3-H4)_2$, while **H2A and H2B form dimers** $(H2A-H2B)$. Under physiologic conditions, these histone oligomers associate to form the **histone octamer** of the composition $(H3-H4)_2-(H2A-H2B)_2$.

The Nucleosome Contains Histone & DNA

When the histone octamer is mixed with purified dsDNA under appropriate ionic conditions, the same x-ray diffraction pattern is formed as that observed in freshly isolated chromatin. Biochemical and electron microscopic studies confirm the existence of reconstituted nucleosomes. Furthermore, the reconstitution of nucleosomes from DNA and histones H2A, H2B, H3, and H4 is independent of the organismal or cellular origin of the various components. Neither the histone H1, nor the nonhistone proteins are necessary for the reconstitution of the nucleosome core.

In the nucleosome, the DNA is supercoiled in a left-handed helix over the surface of the disk-shaped histone octamer (Figure 35–2). The majority of core histone proteins interact with the DNA on the inside of the supercoil without protruding, although the amino terminal tails of all the histones are thought to extend outside of this structure and are available for regulatory PTMs (Table 35–1).

The (H3–H4)₂ tetramer itself can confer nucleosome-like properties on DNA and thus has a central role in the formation of the nucleosome. The addition of two H2A–H2B dimers stabilizes the primary particle and firmly binds two additional half-turns of DNA previously bound only loosely to the (H3–H4)₂. Thus, 1.75 superhelical turns of DNA are wrapped around the surface of the histone octamer, protecting 145 to 150 bp of DNA and forming the nucleosome core particle (Figure 35–2). In chromatin, **core particles are separated by a roughly 30-bp region of DNA termed “linker.”** Most of the DNA is in a repeating series of these structures, giving chromatin a repeating “beads-on-a-string” appearance when examined by electron microscopy (Figure 35–1).

In vivo the assembly of nucleosomes is mediated by one of several nuclear chromatin assembly factors facilitated by histone chaperones, a group of proteins that exhibit high affinity for binding histones. As the nucleosome is assembled, histones are released from the histone chaperones. Nucleosomes appear to exhibit preference for certain regions on specific DNA molecules, but the basis for this nonrandom distribution, termed **phasing**, is not yet completely understood. Phasing is likely related both to the relative physical flexibility of particular nucleotide sequences to accommodate the regions of kinking within the supercoil, as well as the presence of other DNA-bound factors that limit the sites of nucleosome deposition.

HIGHER-ORDER STRUCTURES PROVIDE FOR THE COMPACTION OF CHROMATIN

Electron microscopy of chromatin reveals two higher orders of structure—the 10-nm fibril and the 30-nm chromatin fiber—beyond that of the nucleosome itself. The disk-like nucleosome structure has a 10-nm diameter and a height of 5 nm. The **10-nm fibril** consists of nucleosomes arranged with their edges separated by a small distance (30 bp of linker DNA) with their flat faces parallel to the fibril axis (Figure 35–3). The 10-nm fibril is probably further supercoiled with six or seven nucleosomes per

turn to form the **30-nm chromatin fiber** (Figure 35–3). Each turn of the supercoil is relatively flat, and the faces of the nucleosomes of successive turns would be nearly parallel to each other. H1 histones appear to stabilize the 30-nm fiber, but their position and that of the variable length linker DNA are not clear. It is probable that nucleosomes can form a variety of packed structures. In order to form a mitotic chromosome, the 30-nm fiber must be compacted in length another 100-fold (see below).

In **interphase chromosomes**, chromatin fibers appear to be organized into 30,000 to 100,000 bp **loops or domains** anchored in a **scaffolding**, or supporting matrix within the nucleus, the so-called **nuclear matrix**. Within these domains, some DNA sequences may be located nonrandomly. It has been suggested that each looped domain of chromatin corresponds to one or more separate genetic functions, containing both coding and noncoding regions of the cognate gene or genes. This nuclear architecture is likely dynamic, having important regulatory effects upon gene regulation. Recent data suggest that certain genes or gene regions are mobile within the nucleus, moving obligatorily to discrete loci within the nucleus upon activation. Further work will determine what molecular mechanisms are responsible.

SOME REGIONS OF CHROMATIN ARE “ACTIVE” & OTHERS ARE “INACTIVE”

Generally, every cell of an individual metazoan organism contains the same genetic information. Thus, the differences between cell types within an organism must be explained by differential expression of the common genetic information. Chromatin containing active genes (ie, transcriptionally or potentially transcriptionally active chromatin) has been shown to differ in several ways from that of inactive regions. The nucleosome structure of active chromatin appears to be altered, sometimes quite extensively, in highly active regions. DNA in active chromatin contains large regions (about 100,000 bases long) that are relatively more **sensitive to digestion by a nuclease** such as DNase I. DNase I makes single-strand cuts in nearly any segment of DNA due to its low-sequence specificity. It will digest DNA that is not protected, or bound by protein, into its component deoxynucleotides. The sensitivity to DNase I of active chromatin regions reflects only a potential for transcription rather than transcription itself, and in several different cellular systems can be correlated with a relative lack of 5-methyldeoxycytidine (meC; see Figure 32–7) in the DNA, and particular histone variants and/or histone PTMs

(phosphorylation, acetylation, etc; [Table 35–1](#)).

Within the large regions of active chromatin there exist shorter stretches of 100 to 300 nucleotides that exhibit an even greater (another 10-fold) sensitivity to DNase I. These **hypersensitive sites** probably result from a structural conformation that favors access of the nuclease to the DNA. These regions are often located immediately upstream from the active gene and are the location of interrupted nucleosomal structure caused by the binding of nonhistone regulatory transcription factor proteins (enhancer-binding transcriptional activator proteins; see [Chapters 36](#) and [38](#)). In many cases, it seems that if a gene is capable of being transcribed, it very often has a DNase-hypersensitive site(s) in the chromatin immediately upstream. As noted above, nonhistone regulatory proteins involved in transcription control and those involved in maintaining access to the template strand lead to the formation of hypersensitive sites. Such sites often provide the first clue about the presence and location of a transcription control element.

By contrast, transcriptionally inactive chromatin is densely packed during interphase as observed by electron microscopic studies and is referred to as **heterochromatin**; transcriptionally active chromatin stains less densely and is referred to as **euchromatin**. Generally, euchromatin is replicated earlier than heterochromatin in the mammalian cell cycle (see below). The chromatin in these regions of inactivity is often high in meC content, and histones therein contain relatively lower levels of certain “activating” covalent modifications and higher levels of “repressing” histone PTMs.

There are two types of heterochromatin: constitutive and facultative. **Constitutive heterochromatin** is always condensed and thus essentially inactive. It is found in the regions near the chromosomal centromere and at chromosomal ends (telomeres). **Facultative heterochromatin** is at times condensed, but at other times it is actively transcribed and, thus, uncondensed and appears as euchromatin. Of the two members of the X-chromosome pair in mammalian females, one X chromosome is almost completely inactive transcriptionally and is heterochromatic. However, the heterochromatic X chromosome decondenses during gametogenesis and becomes transcriptionally active during early embryogenesis—thus, it is facultative heterochromatin.

Certain cells of insects, for example, *Chironomus* and *Drosophila*, contain giant chromosomes that have been replicated for multiple cycles without separation of daughter chromatids. These copies of DNA line up side by side in precise register and produce a banded chromosome

containing regions of condensed chromatin and lighter bands of more extended chromatin. Transcriptionally active regions of these **polytene chromosomes** are especially decondensed into “**puffs**” that can be shown to contain the enzymes responsible for transcription and to be the sites of RNA synthesis (**Figure 35–4**). Using highly sensitive fluorescently labeled hybridization probes, specific gene sequences can be mapped, or “painted,” within the nuclei of human cells, even without polytene chromosome formation, using fluorescence in situ hybridization (FISH; see **Chapter 39**) techniques.

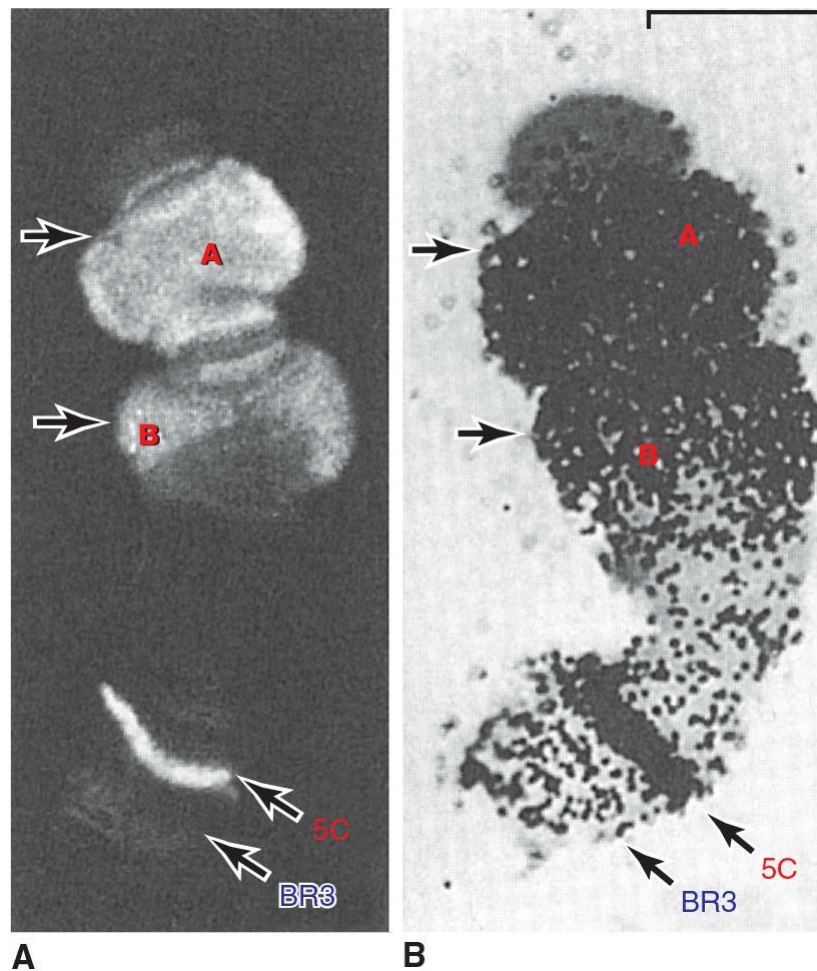

FIGURE 35–4 Illustration of the tight correlation between the presence of RNA polymerase II (**Table 36–2**) and messenger RNA synthesis. A number of genes, labeled A, B (top), and 5C, but not genes at locus (band) BR3 (5C, BR3, bottom) are activated when midge fly *Chironomus tentans* larvae are subjected to heat shock (39°C for 30 minutes). (A) Distribution of RNA polymerase II in isolated chromosome IV from the salivary gland (**at arrows**). The enzyme was detected by immunofluorescence using a fluorescently labeled antibody directed

against the polymerase. The 5C and BR3 are specific bands of chromosome IV, and the arrows indicate puffs (ie, A, B, 5C). (B)

Autoradiogram of a chromosome IV that was incubated in ^3H -uridine to label the RNA. Note the correspondence of the immunofluorescence and presence of the radioactive RNA (black dots) (ie, A, B, 5C). Bar = 7 μm . (Reproduced, with permission, from Sass H: RNA polymerase B in polytene chromosomes. *Cell* 1982;28:274. Copyright © 1982. Reprinted with permission from Elsevier.)

DNA IS ORGANIZED INTO CHROMOSOMES

At metaphase, mammalian **chromosomes** possess a twofold symmetry, with the identical duplicated **sister chromatids** connected at a **centromere**, the relative position of which is characteristic for a given chromosome (**Figure 35–5**). The centromere is an adenine–thymine (A–T)-rich region containing repeated DNA sequences that range in size from 10^2 (brewers' yeast) to 10^6 (mammals) **base pairs (bp)**. Metazoan centromeres are bound by nucleosomes containing the histone H3 variant protein CENP-A and other specific centromere-binding proteins. This complex, called the **kinetochore**, provides the anchor for the mitotic spindle. Thus, it is an essential structure for chromosomal segregation during mitosis.

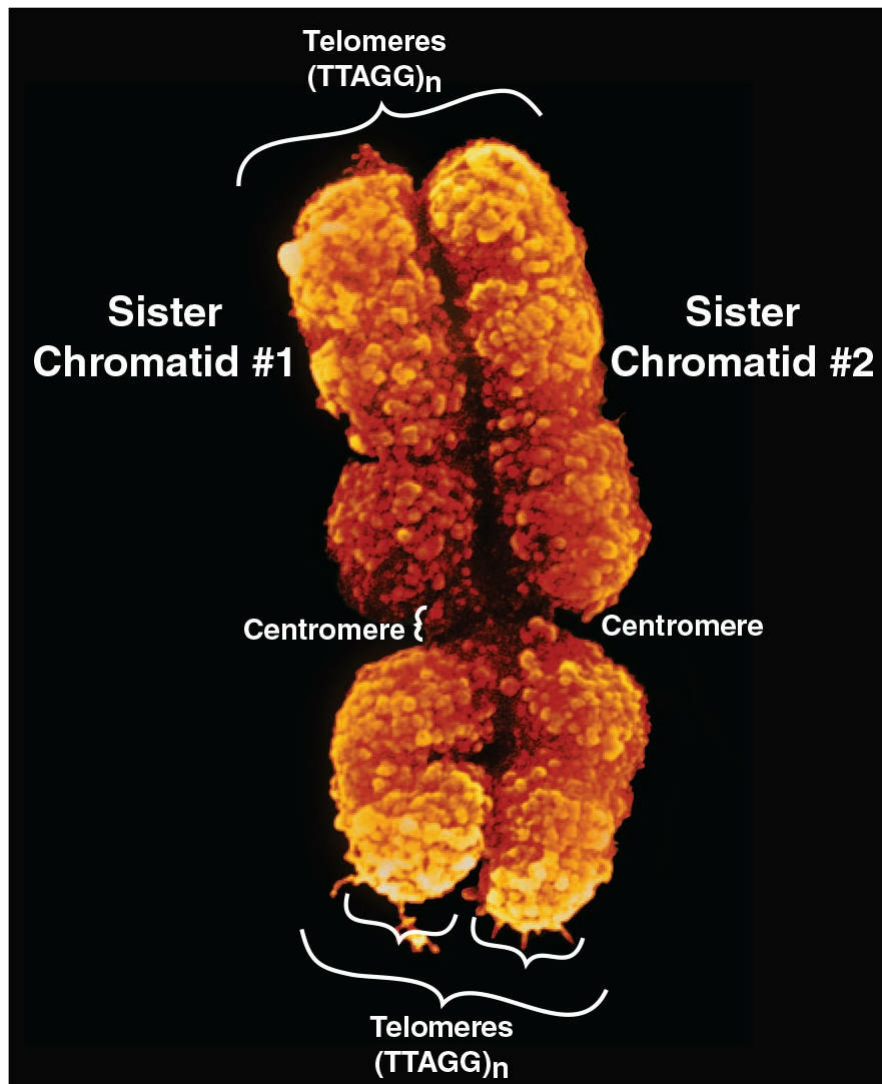

FIGURE 35–5 The two sister chromatids of mitotic human chromosome 12. The location of the A+T-rich centromeric region connecting sister chromatids is indicated, as are two of the four telomeres residing at the very ends of the chromatids that are attached one to the other at the centromere. (Reprinted with permission from Biophoto Associates/Photo Researchers, Inc.)

The ends of each chromosome contain structures called **telomeres**. **Telomeres consist of short TG-rich repeats.** Human telomeres have a variable number of repeats of the sequence 5'-TTAGGG-3', which can extend for several kilobases. **Telomerase**, a multisubunit RNA template-containing complex related to viral RNA-dependent DNA polymerases (reverse transcriptases), is the enzyme responsible for telomere synthesis and thus for maintaining the length of the telomere. Since telomere shortening has been associated with both malignant transformation ([Chapter 56](#)) and aging ([Chapter 58](#)), this enzyme has become an attractive

target for cancer chemotherapy and drug development (see [Chapter 56](#)). Each sister chromatid contains one dsDNA molecule. As schematized in [Figure 35–3](#), during interphase, the packing of the DNA molecule is less dense than it is in the condensed chromosome during metaphase. Metaphase chromosomes are nearly completely transcriptionally inactive.

The human haploid genome consists of about 3×10^9 bp and about 1.7×10^7 nucleosomes. Thus, each of the 23 chromatids in the human haploid genome would contain on the average 1.3×10^8 nucleotides in one dsDNA molecule. Therefore, the length of each DNA molecule must be compressed about 8000-fold to generate the structure of a condensed metaphase chromosome. In metaphase chromosomes, the 30-nm chromatin fibers are also folded into a series of **looped domains**, the proximal portions of which are anchored to the nuclear matrix, likely through interactions with proteins termed **lamins** that constitute integral components of the inner nuclear membrane within the nucleus ([Figures 35–3](#) and [49–4](#)). The packing ratios of each of the orders of DNA structure are summarized in [Table 35–2](#). The packaging of nucleoproteins within chromatids is not random, as evidenced by the characteristic patterns observed when chromosomes are stained with specific dyes such as quinacrine or Giemsa stain ([Figure 35–6](#)).

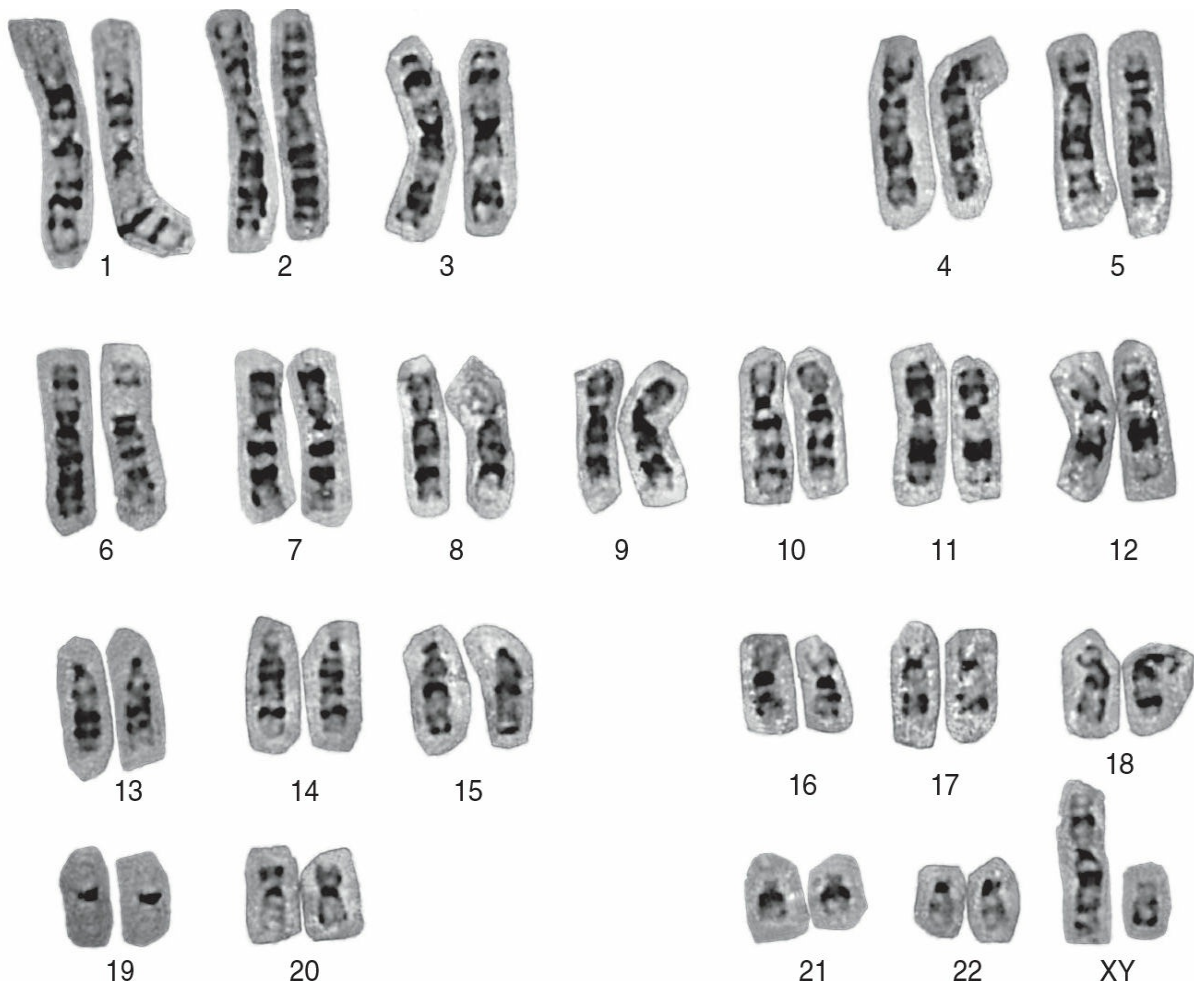

FIGURE 35–6 A human karyotype (of a man with a normal 46,XY constitution), in which the metaphase chromosomes have been stained by the Giemsa method and aligned according to the Paris Convention. (Reprinted with permission from H Lawce and F Conte.)

From individual to individual within a single species, the pattern of staining (banding) of the entire chromosome complement is highly reproducible; nonetheless, it differs significantly between species, even those closely related. Thus, the packaging of the nucleoproteins in chromosomes of higher eukaryotes must in some way be dependent on species-specific characteristics of the DNA molecules.

A combination of specialized staining techniques and high-resolution microscopy has allowed cytogeneticists to quite precisely map many genes to specific regions of mouse and human chromosomes. With the recent elucidation of the human and mouse genome sequences (among others), it has become clear that many of these visual mapping methods were remarkably accurate.

Coding Regions Are Often Interrupted by Intervening Sequences

The protein coding regions of DNA, the transcripts of which ultimately appear in the cytoplasm as single mRNA molecules, are usually interrupted in the eukaryotic genome by large intervening sequences of nonprotein-coding DNA. Accordingly, the **primary transcripts** or **mRNA precursors** (originally termed **hnRNA** because this species of RNA was quite heterogeneous in size [length] and mostly restricted to the nucleus), contain noncoding intervening sequences of RNA that must be removed in a process which also joins together the appropriate coding segments to form the mature mRNA. Most coding sequences for a single mRNA are interrupted in the genome (and thus in the primary transcript) by at least one—and in some cases as many as 50—noncoding intervening sequences (**introns**). In most cases, the introns are much longer than the coding regions (**exons**). The processing of the primary transcript, which involves precise removal of introns and splicing of adjacent exons, is described in [Chapter 36](#).

The function of the intervening sequences, or introns, is not totally clear. However, mRNA precursor molecules can be differentially spliced thereby increasing the number of distinct (yet related) proteins produced by a single gene and its corresponding primary mRNA gene transcript. Introns may also serve to separate functional domains (exons) of coding information in a form that permits genetic rearrangement by recombination to occur more rapidly than if all coding regions for a given genetic function were contiguous. Such an enhanced rate of genetic rearrangement of functional domains might allow more rapid evolution of biologic function. In some instances, other protein-coding or noncoding RNAs are localized within the intronic DNA of certain genes (see [Chapter 34](#)). The relationships among chromosomal DNA, gene clusters on the chromosome, the exon–intron structure of genes, and the final mRNA product are illustrated in [Figure 35–7](#).

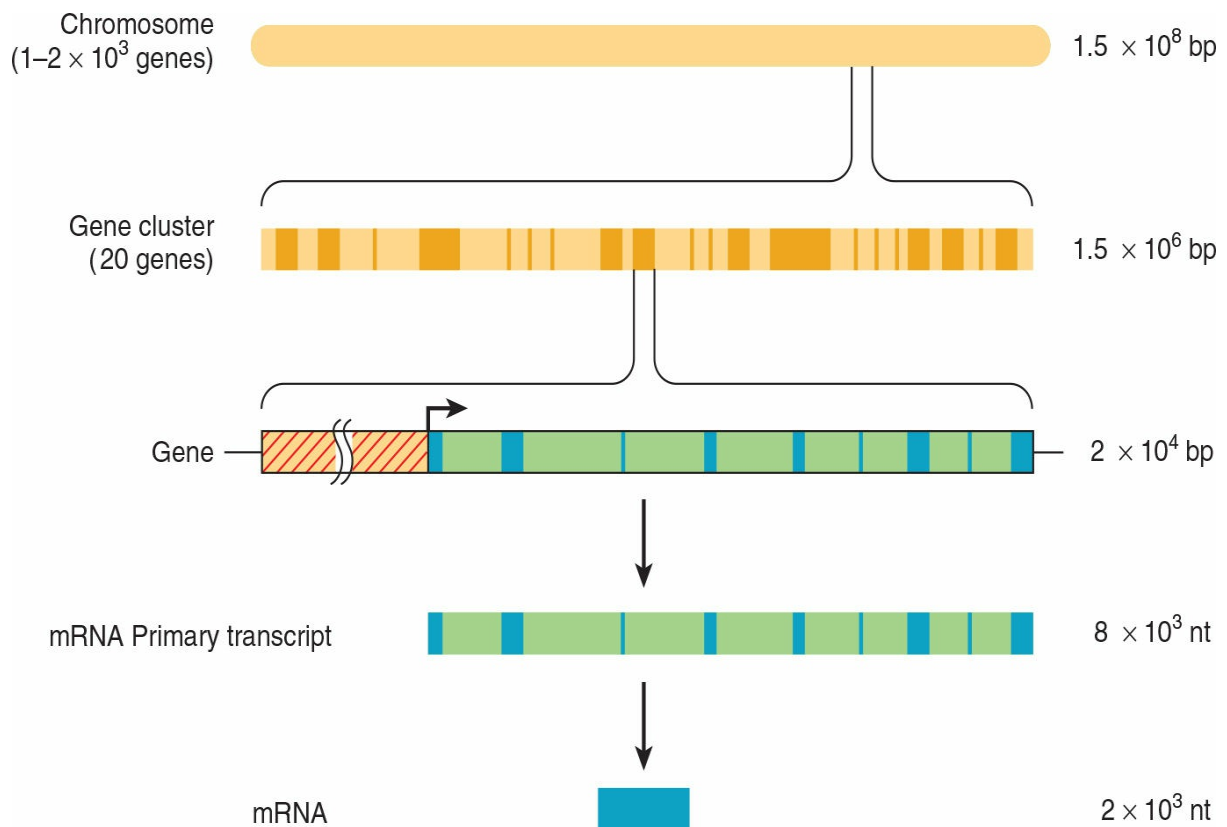

FIGURE 35–7 The relationship between chromosomal DNA and mRNA. The human haploid DNA complement of 3×10^9 bp is unequally distributed between 23 chromosomes (see Figure 35–6). Genes are often clustered on these chromosomes. An average gene is 2×10^4 bp in length, including the regulatory region (red-hatched area), which is often located at the 5' end of the gene. The regulatory region is shown here as being adjacent to the transcription initiation site (bent arrow). Most eukaryotic genes have alternating exons and introns. In this example, there are nine exons (blue-colored areas) and eight introns (green-colored areas). The introns are removed from the primary transcript by processing reactions, and the exons are ligated together in sequence to form the mature mRNA through a process termed RNA splicing. (nt, nucleotides.)

THE EXACT FUNCTION OF MUCH OF THE MAMMALIAN GENOME IS NOT WELL UNDERSTOOD

The haploid genome of each human cell consists of 3.3×10^9 bp of DNA subdivided into 23 chromosomes. The entire haploid genome contains sufficient DNA to code for nearly 1.5 million average-sized protein coding

genes (i.e., ~2200 bp of protein-coding DNA). However, early studies of mutation rates and of the complexities of the genomes of higher organisms suggested that humans have significantly fewer than 100,000 proteins encoded by the ~1% of the human genome that is composed of exonic DNA. Indeed, current estimates based on sequencing of the human genome suggest there are about 25,000 protein-coding genes in humans. This implies that most genomic DNA is nonprotein coding—that is, its information is never translated into an amino acid sequence of a protein molecule. Certainly, some of the excess DNA sequences serve to regulate the expression of genes during development, differentiation, and adaptation to the environment, either by serving as binding sites for regulatory proteins or by encoding regulatory ncRNAs. Some excess clearly makes up the intervening sequences or introns that split the coding regions of genes, and another portion of the excess appears to be composed of many families of repeated sequences for which clear functions have yet to be defined, though some small RNAs transcribed from these repeats can modulate transcription, either directly by interacting with the transcription machinery or indirectly by affecting the activity of the chromatin template. Interestingly, the ENCODE Project Consortium (see [Chapters 10](#) and [39](#)) has shown that most of the genomic sequence is indeed transcribed in at least some human cell types, albeit at a low level. A large fraction of such transcription appears to generate the lncRNAs (see [Chapter 34](#)). Further research will elucidate the role(s) played by such transcripts.

The DNA in a eukaryotic genome can be divided into two broad “sequence classes.” These are unique-sequence DNA, or nonrepetitive DNA and repetitive-sequence DNA. In the haploid genome, unique-sequence DNA generally includes the single copy genes that code for proteins. The repetitive DNA in the haploid genome includes sequences that vary in copy number from 2 to as many as 10^7 copies per cell.

More Than Half the DNA in Eukaryotic Organisms Is in Unique or Nonrepetitive Sequences

This estimation and genome-wide organization of repetitive sequence DNA was based on a variety of techniques, and most recently on direct genomic DNA sequencing. Similar techniques were used to determine the number of protein-encoding genes. In brewers' yeast (*Saccharomyces cerevisiae*, a lower eukaryote), about two-thirds of its 6200 genes are expressed, but only ~one-fifth are required for viability under laboratory

growth conditions. In typical tissues in a higher eukaryote (eg, mammalian liver and kidney), between 10,000 and 15,000 genes are actively expressed. Different combinations of genes are expressed in each tissue of course, and how this is accomplished is one of the major unanswered questions in biology.

In Human DNA, at Least 30% of the Genome Consists of Repetitive Sequences

Repetitive-sequence DNA can be broadly classified as moderately repetitive or as highly repetitive. The highly repetitive sequences consist of 5 to 500 base pair lengths repeated many times in tandem. These sequences are often clustered in centromeres and telomeres of the chromosome and some are present in about 1 to 10 million copies per haploid genome. The majority of these sequences are transcriptionally inactive and some of these sequences play a structural role in the chromosome ([Figure 35–5](#); see [Chapter 39](#)).

The moderately repetitive sequences, which are defined as being present in numbers of less than 10^6 copies per haploid genome, are not clustered but are interspersed with unique sequences. In many cases, these long interspersed repeats are transcribed by RNA polymerase II and contain 5-Cap structures indistinguishable from those on mRNA. Depending on their length, moderately repetitive sequences are classified as **long interspersed nuclear elements (LINEs)** or **short interspersed nuclear elements (SINEs)**. Both types appear to be **retroposons**; that is, they arose from movement from one location to another (**transposition**) through an RNA intermediate by the action of reverse transcriptase that transcribes an RNA template into DNA. Mammalian genomes contain 20,000 to 50,000 copies of the 6 to 7 kbp LINEs. These represent species-specific families of repeat elements. SINEs are shorter (70-300 bp), and there may be more than 100,000 copies per genome. Of the SINEs in the human genome, one family, the **Alu family**, is present in about 500,000 copies per haploid genome and accounts for ~10% of the human genome. Members of the human Alu family and their closely related analogs in other animals can be transcribed as integral components of mRNA precursors or as discrete RNA molecules, including the well-studied 4.5S RNA and 7S RNA. These particular family members are highly conserved within a species as well as between mammalian species. Components of the short-interspersed repeats, including the members of the Alu family, may be mobile elements, capable of jumping into and out of various sites

within the genome (see below). These transposition events can have disastrous results, as exemplified by the insertion of Alu sequences into a gene, which, when so mutated, causes neurofibromatosis. Additionally, Alu B1 and B2 SINE RNAs have been shown to regulate mRNA production at the levels of transcription and mRNA splicing.

Microsatellite Repeat Sequences

One category of repeat sequences exists as both dispersed and grouped tandem arrays. The sequences consist of 2 to 6 bp repeated up to 50 times. These **microsatellite sequences** most commonly are found as dinucleotide repeats of AC on one strand and TG on the opposite strand, but several other forms occur, including CG, AT, and CA. The AC repeat sequences occur at 50,000 to 100,000 locations in the genome. At any locus, the number of these repeats may vary on the two chromosomes, thus providing heterozygosity of the number of copies of a particular microsatellite number in an individual. This is a heritable trait, and because of their number and the ease of detecting them using the **polymerase chain reaction (PCR)** (see [Chapter 39](#)), such repeats are useful in constructing genetic linkage maps. Most genes are associated with one or more microsatellite markers, so the relative position of genes on chromosomes can be assessed, as can the association of a gene with a disease. Using PCR, a large number of family members can be rapidly screened for a certain **microsatellite polymorphism**. The association of a specific polymorphism with a gene in affected family members—and the lack of this association in unaffected members—may be the first clue about the genetic basis of a disease.

Trinucleotide sequences that increase in number (microsatellite instability) can cause disease. The unstable $(CGG)_n$ repeat sequence is associated with the fragile X syndrome. Other trinucleotide repeats that undergo dynamic mutation (usually an increase) are associated with Huntington chorea (CAG), myotonic dystrophy (CTG), spinobulbar muscular atrophy (CAG), and Kennedy disease (CAG). The advent of next-generation DNA sequencing technologies (see [Chapter 39](#)) has dramatically impacted both the speed, accuracy, and precision with which scientists and clinicians can analyze human genome structure. Some newly instituted clinical tests involve targeted genomic DNA sequencing prepared either from tissues or serum samples.

ONE PERCENT OF CELLULAR DNA IS IN MITOCHONDRIA

The majority of the polypeptides in mitochondria (about 54 out of 67) are encoded by nuclear genes, while the rest are coded by genes found in mitochondrial (mt) DNA. Human mitochondria contains 2 to 10 copies of a small circular ~16 kbp dsDNA molecule that makes up approximately 1% of total cellular DNA. This mtDNA codes for mt-specific ribosomal and transfer RNAs and for 13 proteins that play key roles in the respiratory chain (see [Chapter 13](#)). The linearized structural map of the human mitochondrial genes is shown in [Figure 35–8](#). Some of the features of mtDNA are shown in [Table 35–3](#).

TABLE 35–3 Major Features of Human Mitochondrial DNA

<ul style="list-style-type: none">• Is circular, double-stranded, and composed of heavy (H) and light (L) chains or strands
<ul style="list-style-type: none">• Contains 16,569 bp
<ul style="list-style-type: none">• Encodes 13 protein subunits of the respiratory chain (of a total of about 67)<ul style="list-style-type: none">Seven subunits of NADH dehydrogenase (complex I)Cytochrome <i>b</i> of complex IIIThree subunits of cytochrome oxidase (complex IV)Two subunits of ATP synthase
<ul style="list-style-type: none">• Encodes large (16S) and small (12S) mt ribosomal RNAs
<ul style="list-style-type: none">• Encodes 22 mt tRNA molecules
<ul style="list-style-type: none">• Genetic code differs slightly from the standard code<ul style="list-style-type: none">UGA (standard stop codon) is read as TrpAGA and AGG (standard codons for Arg) are read as stop codons
<ul style="list-style-type: none">• Contains very few untranslated sequences
<ul style="list-style-type: none">• High mutation rate (5-10 times that of nuclear DNA)
<ul style="list-style-type: none">• Comparisons of mtDNA sequences provide evidence about evolutionary origins of primates and other species

Source: Adapted from Harding AE: Neurological disease and mitochondrial genes. *Trends Neurol Sci* 1991;14:132. Copyright © 1991. Reprinted with permission from Elsevier.

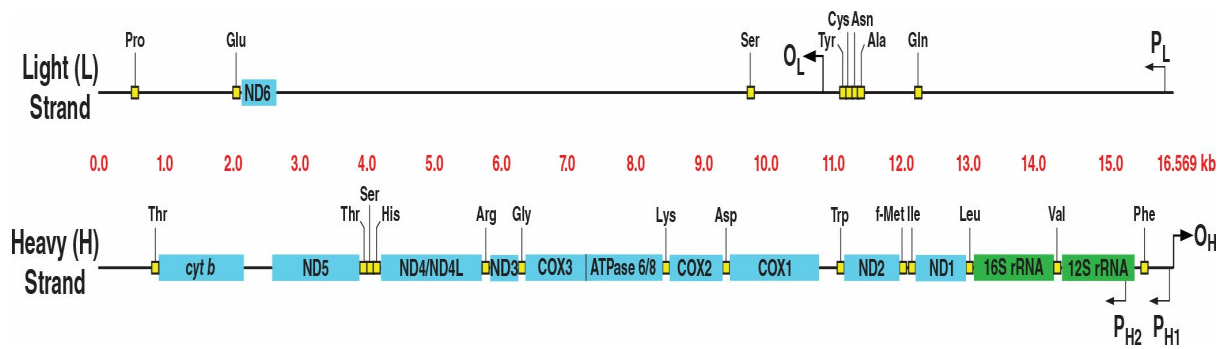

FIGURE 35–8 Map of human mitochondrial genes. The maps represent the so-called light (L; upper) and heavy (H; lower) strands of the 16,569 base pair linearized mitochondrial (mt) DNA. The maps show the mt genes encoding subunits of NADH-coenzyme Q oxidoreductase (ND1 through ND6), cytochrome *c* oxidase (COX1 through COX3), cytochrome *b* (*cyt b*), ATP synthase (ATPase 6 and 8) and the 12S and 16S mt ribosomal rRNAs. Mt transfer RNA (tRNA) encoding genes are denoted by small yellow boxes and the three-letter code indicating the cognate amino acids which they specify during mt translation. The origin of heavy-strand (O_H), and light-strand (O_L) DNA replication, as well as the promoters for the initiation of heavy-strand (P_{H1} and P_{H2}), and light-strand (P_L) transcription are indicated by arrows and letters (see also [Table 57–3](#)). Figure generated using *Homo sapiens* mitochondrion, complete genome; Sequence: NCBI Reference NC_012920.1 and annotations therein.

An important feature of human mitochondrial mtDNA is that—because all mitochondria are contributed by the ovum during zygote formation—it is transmitted by maternal nonmendelian inheritance. Thus, in diseases resulting from mutations of mtDNA, an affected mother would in theory pass the disease to all of her children but only her daughters would transmit the trait. However, in some cases, deletions in mtDNA occur during oogenesis and thus are not inherited from the mother. A number of diseases have now been shown to be due to mutations of mtDNA. These include a variety of myopathies, neurologic disorders, and some forms of diabetes mellitus.

GENETIC MATERIAL CAN BE ALTERED & REARRANGED

An alteration in the sequence of purine and pyrimidine bases in a gene due

to a change—a removal or an insertion—of one or more bases may result in an altered gene product or alteration of gene expression if nonprotein coding DNA is involved. Such insertions or deletions are termed **indels**. Indels often result in a **mutation** whose consequences are discussed in detail in [Chapter 37](#).

Chromosomal Recombination Is One Way of Rearranging Genetic Material

Genetic information can be exchanged between similar or homologous chromosomes. The exchange, or **recombination** event, occurs primarily during meiosis in mammalian cells and requires alignment of homologous metaphase chromosomes, an alignment that almost always occurs with great exactness. A process of crossing over occurs as shown in [Figure 35–9](#). This usually results in an equal and reciprocal exchange of genetic information between homologous chromosomes. If the homologous chromosomes possess different alleles of the same genes, the crossover may produce noticeable and heritable genetic linkage differences. In the rare case where the alignment of homologous chromosomes is not exact, the crossing over or recombination event may result in an unequal exchange of information. One chromosome may receive less genetic material and thus a deletion, while the other partner of the chromosome pair receives more genetic material and thus an insertion or duplication. One well-studied example of unequal crossing that occurs in humans involves the genes encoding hemoglobins. Unequal crossing over results in a human hemoglobinopathy designated Lepore and anti-Lepore ([Figure 35–10](#)).

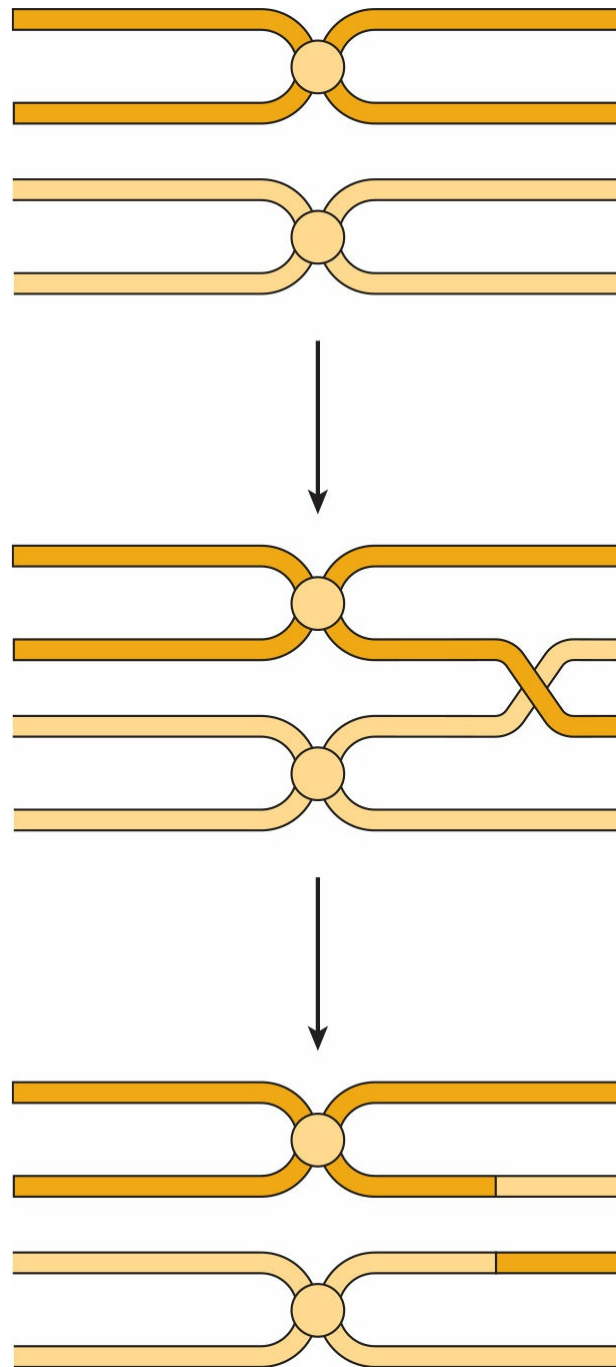

FIGURE 35–9 The process of crossing over between homologous metaphase chromosomes to generate recombinant chromosomes. See also [Figure 35–12](#).

The farther apart any two genes are on an individual chromosome, the greater the likelihood of a crossover recombination event. This is the basis for genetic mapping methods. **Unequal crossover** affects tandem arrays of repeated DNAs whether they are related globin genes, as in [Figure 35–10](#), or more abundant repetitive DNA. Unequal crossover through slippage in the pairing can result in expansion or contraction in the copy number of

the repeat family and may contribute to the expansion and fixation of variant members throughout the repeat array.

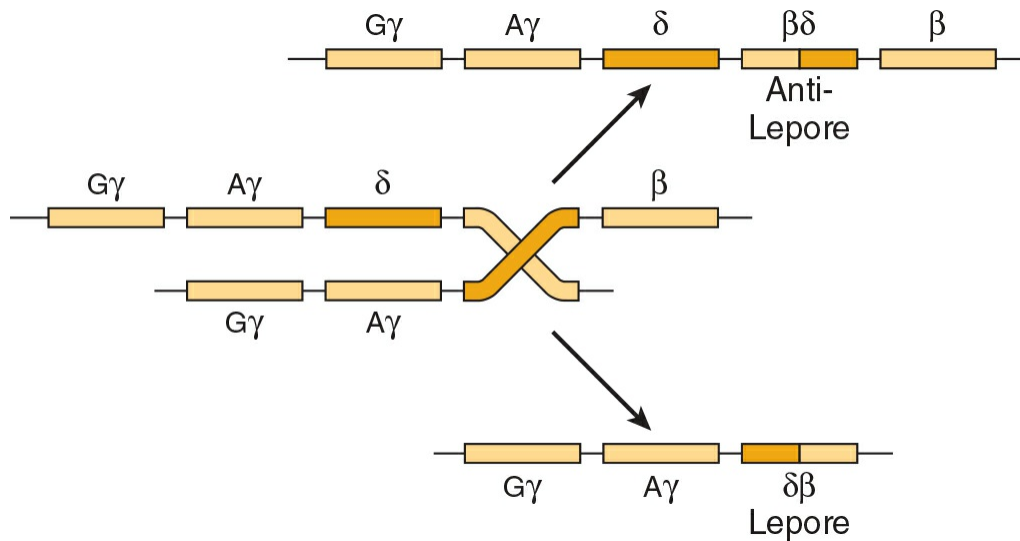

FIGURE 35–10 The process of unequal crossover in the region of the mammalian genome that harbors the structural genes encoding hemoglobins and the generation of the unequal recombinant products hemoglobin delta-beta Lepore and beta-delta anti-Lepore. The examples given show the locations of the crossover regions within amino acid coding regions of the indicated genes (ie, β and δ globin genes). (Redrawn and reproduced, with permission, from Clegg JB, Weatherall DJ: β^0 Thalassemia: time for a reappraisal? *Lancet* 1974;2:133. Copyright © 1974. Reprinted with permission from Elsevier.)

Chromosomal Integration Occurs With Some Viruses

Some bacterial viruses (bacteriophages) are capable of recombining with the DNA of a bacterial host in such a way that the genetic information of the bacteriophage is incorporated in a linear fashion into the genetic information of the host. This integration, which is a form of recombination, occurs by the mechanism illustrated in [Figure 35–11](#). The backbone of the circularized bacteriophage genome is broken, as is that of the DNA molecule of the host; the appropriate ends are resealed with the proper polarity. The bacteriophage DNA is figuratively straightened out (“linearized”) as it is integrated into the bacterial DNA molecule—frequently a closed circle as well. The site at which the bacteriophage genome integrates or recombines with the bacterial genome is chosen by one of two mechanisms. If the bacteriophage contains a DNA sequence **homologous** to a sequence in the host DNA molecule, then a

recombination event analogous to that occurring between homologous chromosomes can occur. However, some bacteriophages synthesize proteins that bind specific sites on bacterial chromosomes to a **nonhomologous** site characteristic of the bacteriophage DNA molecule. Integration occurs at the site and is said to be “**site specific.**”

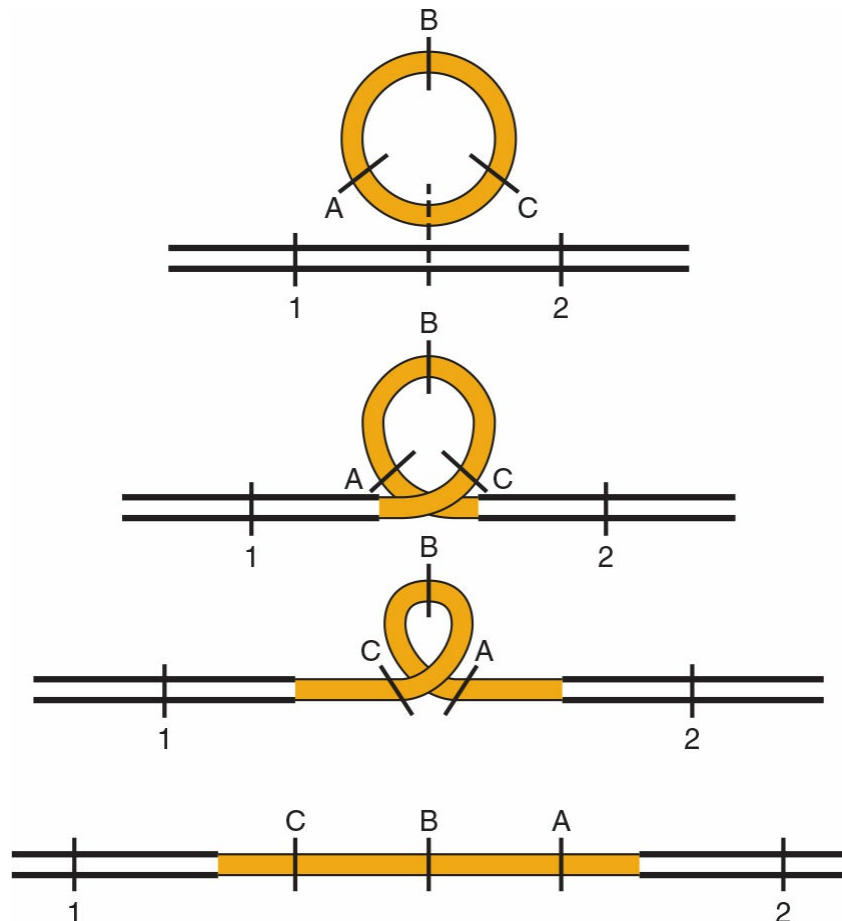

FIGURE 35–11 The integration of a circular genome from a virus (with genes A, B, and C) into the DNA molecule of a host (with genes 1 and 2) and the consequent ordering of the genes.

Many animal viruses, particularly the oncogenic viruses—either directly or, in the case of RNA viruses such as HIV that causes AIDS, double-stranded DNA copies generated by the action of the viral **RNA-dependent DNA polymerase**, or **reverse transcriptase**—can be integrated into chromosomes of the mammalian cell. Integration of the viral DNA into the genome of the infected cells generally is not “site specific” but does display site preferences; such insertions can be mutagenic.

Transposition Can Produce Processed Genes

In eukaryotic cells, small DNA elements that clearly are not viruses are capable of transposing themselves in and out of the host genome in ways that affect the function of neighboring DNA sequences. These mobile elements, sometimes called “**jumping DNA**,” or jumping genes, can carry flanking regions of DNA and, therefore, profoundly affect evolution. As mentioned above, the Alu family of moderately repeated DNA sequences has structural characteristics similar to the termini of retroviruses, which would account for the ability of the latter to move into and out of the mammalian genome.

Direct evidence for the transposition of other small DNA elements into the human genome has been provided by the discovery of “**processed genes**” for immunoglobulin molecules, α -globin molecules, and many others. These processed genes consist of DNA sequences identical or nearly identical to those of the messenger RNA for the appropriate gene product. That is, the 5'-nontranslated region, the coding region without intron representation, and the 3' poly(A) tail are all present contiguously. This particular DNA sequence arrangement must have resulted from the reverse transcription of an appropriately processed messenger RNA molecule from which the intron regions had been removed and the poly(A) tail added. The only recognized mechanism that this reverse transcript could have used to integrate into the genome would have been a transposition event. In fact, these “processed genes” have short terminal repeats at each end, as do known transposed sequences in other organisms. In the absence of their transcription and thus genetic selection for function, many of the processed genes have been randomly altered through evolution so that they now contain nonsense codons that preclude their ability to encode a functional, intact protein even if they could be transcribed (see [Chapter 37](#)). Thus, they are referred to as “**pseudogenes**.”

Gene Conversion Produces Rearrangements

Besides unequal crossover and transposition, a third mechanism can effect rapid changes in the genetic material. Similar sequences on homologous or nonhomologous chromosomes may occasionally pair up and eliminate any mismatched sequences between them. This may lead to the accidental fixation of one variant or another throughout a family of repeated sequences and thereby homogenize the sequences of the members of repetitive DNA families. This process is referred to as **gene conversion**.

Sister Chromatids Exchange

In diploid eukaryotic organisms such as humans, after cells progress through the S phase, they contain a tetraploid content of DNA. This is in the form of sister chromatids of chromosome pairs (Figure 35–6). Each of these sister chromatids contains identical genetic information since each is a product of the semiconservative replication of the original parent DNA molecule of that chromosome. Crossing over can occur between these genetically identical sister chromatids. Of course, these **sister chromatid exchanges** (Figure 35–12) have no genetic consequence as long as the exchange is the result of an equal crossover.



FIGURE 35–12 Sister chromatid exchanges between human chromosomes. The exchanges are detectable by Giemsa staining of the chromosomes of cells replicated for two cycles in the presence of bromodeoxyuridine. The arrows indicate some regions of exchange.

(Reprinted with permission from S Wolff and J Bodycote.)

Immunoglobulin Genes Rearrange

In mammalian cells, some interesting gene rearrangements occur normally during development and differentiation. For example, the V_L and C_L genes, which encode for the immunoglobulin G (IgG) light-chain variable (V_L) and constant (C_L) portions of the IgG light chain in a single IgG molecule (see [Chapters 38, 52](#)), are widely separated in the germ line DNA. In the DNA of a differentiated IgG-producing (plasma) cell, the same V_L and C_L genes have been moved physically closer, and linked together in the genome within a single transcription unit. However, even then, this rearrangement of DNA during differentiation does not bring the V_L and C_L genes into contiguity in the DNA. Instead, the DNA contains an intron of about 1200 bp at or near the junction of the V and C regions. This intron sequence is transcribed into RNA along with the V_L and C_L exons, and the interspersed, intronic non-IgG sequence information is removed from the RNA during its nuclear processing (see [Chapters 36 and 38](#)).

DNA SYNTHESIS & REPLICATION ARE RIGIDLY CONTROLLED

The primary function of DNA replication is the provision of progeny with the genetic information possessed by the parent. Thus, the replication of DNA must be complete and carried out in such a way as to maintain genetic stability within the organism and the species. The process of DNA replication is complex and involves many cellular functions and several verification procedures to ensure fidelity in replication. About 30 proteins are involved in the replication of the *Escherichia coli* chromosome, and this process is more complex in eukaryotic organisms.

In all cells, replication can occur only from a single-stranded DNA (ssDNA) template. Therefore, mechanisms must exist to target the site of initiation of replication and to unwind the dsDNA in that region. The replication complex must then form. After replication is complete in an area, the parent and daughter strands must reform dsDNA. In eukaryotic cells, an additional step must occur. The dsDNA must reform the chromatin structure, including nucleosomes that existed prior to the onset of replication. Although this entire process is not completely understood in

eukaryotic cells, replication has been quite precisely described in prokaryotic cells, and the general principles are the same in both. The major steps are listed in **Table 35–4**, illustrated in **Figure 35–13**, and discussed, in sequence, below. A number of proteins, most with specific enzymatic action, are involved in this process (**Table 35–5**).

TABLE 35–4 Steps Involved in DNA Replication in Eukaryotes

1. Identification of the origins of replication
2. ATP hydrolysis-driven removal of nucleosomes and unwinding of dsDNA to provide an ssDNA template
3. Formation of the replication fork; synthesis of RNA primer
4. Initiation of DNA synthesis and elongation
5. Formation of replication bubbles with ligation of the newly synthesized DNA segments
6. Reconstitution of chromatin structure

TABLE 35–5 Classes of Proteins Involved in Replication

Protein	Function
DNA polymerases	Deoxynucleotide polymerization
Helicases	ATP-driven processive unwinding of DNA
Topoisomerases	Relieve torsional strain that results from helicase-induced unwinding
DNA primase	Initiates synthesis of RNA primers
Single-strand binding proteins (SSBs)	Prevent premature reannealing ssDNA strands to form dsDNA
DNA ligase	Seals the single-strand nick between the nascent chain and Okazaki fragments on lagging strand

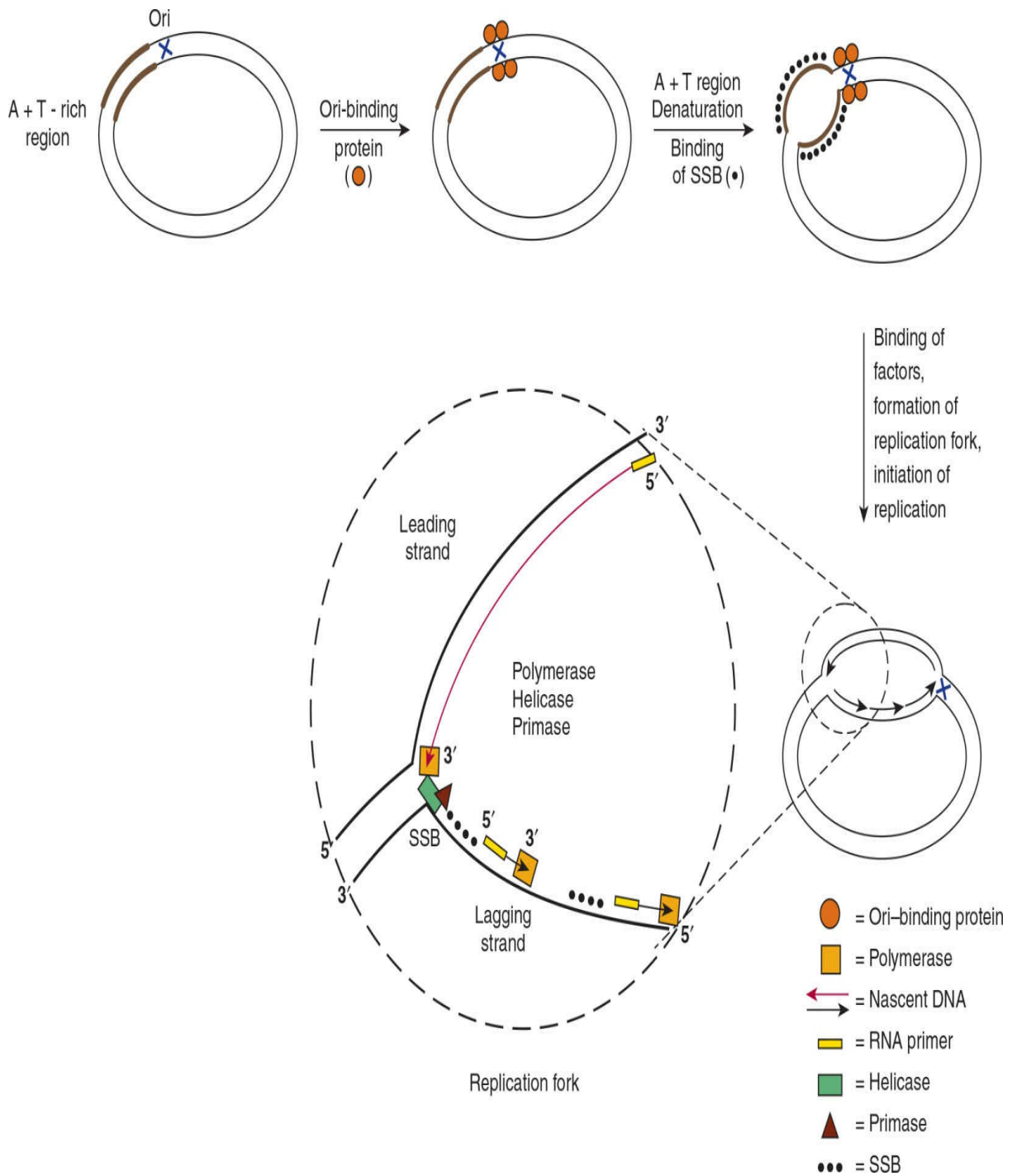

FIGURE 35–13 Steps involved in DNA replication. This figure describes DNA replication in an *E. coli* cell, but the general steps are similar in eukaryotes. A specific interaction of a protein (the *dnaA* protein) to the origin of replication (*oriC*) results in local unwinding of DNA at an adjacent A+T-rich region. The DNA in this area is maintained in the single-strand conformation (ssDNA) by single-strand-binding proteins (SSBs). This allows a variety of proteins, including helicase, primase, and DNA polymerase, to bind and to initiate DNA synthesis. The replication fork proceeds as DNA synthesis occurs continuously (long red arrow) on

the leading strand and discontinuously (short black arrows) on the lagging strand. The nascent DNA is always synthesized in the 5' to 3' direction, as DNA polymerases can add a nucleotide only to the 3' end of a DNA strand.

The Origin of Replication

At the **origin of replication (ori)**, there is an association of sequence-specific dsDNA-binding proteins with a series of direct repeat DNA sequences. In *E. coli*, the *oriC* is bound by the protein *dnaA*, which forms a complex consisting of 150 to 250 bp of DNA and multimers of the DNA-binding protein. This leads to the local denaturation and unwinding of an adjacent A+T-rich region of DNA. Functionally similar **autonomously replicating sequences (ARS) or replicators** have been identified in yeast cells. The ARS contains a somewhat degenerate 11-bp sequence called the **origin replication element (ORE)**. The ORE binds a set of proteins, analogous to the *dnaA* protein of *E. coli*, the group of proteins is collectively called the **origin recognition complex (ORC)**. ORC homologs have been found in all eukaryotes examined. The ORE is located adjacent to an approximately 80-bp A+T-rich sequence that is easy to unwind. This is called the **DNA unwinding element (DUE)**. The DUE is the origin of replication in yeast and is bound by the MCM protein complex.

Consensus sequences similar to *ori* or ARS in structure have not been precisely defined in mammalian cells, though several of the proteins that participate in *ori* recognition and function have been identified and appear quite similar to their yeast counterparts in both amino acid sequence and function.

Unwinding of DNA

The interaction of proteins with *ori* defines the start site of replication and provides a short region of ssDNA essential for initiation of synthesis of the nascent DNA strand. This process requires the formation of a number of protein–protein and protein-DNA interactions. A critical step is provided by a DNA helicase that allows for processive unwinding of DNA. This function is provided by a complex of *dnaB* helicase and the *dnaC* protein. Single-stranded DNA-binding proteins (SSBs) stabilize this complex.

Formation of the Replication Fork

A replication fork consists of four components that form in the following sequence: (1) the DNA helicase unwinds a short segment of the parental duplex DNA; (2) SSBs bind to ssDNA and prevent premature reannealing of ssDNA to dsDNA; (3) a primase initiates synthesis of an RNA molecule that is essential for priming DNA synthesis; and (4) the DNA polymerase initiates nascent, daughter-strand synthesis.

The DNA polymerase III enzyme (the *dnaE* gene product in *E. coli*) binds to template DNA as part of a multiprotein complex that consists of several polymerase accessory factors (β' , γ , δ , δ' , and τ). DNA polymerases only synthesize DNA in the 5' to 3' direction, and only one of the several different types of polymerases is involved at the replication fork. Because the DNA strands are antiparallel (see [Chapter 34](#)), the polymerase functions asymmetrically. On the **leading (forward) strand**, the DNA is synthesized continuously. On the **lagging (retrograde) strand**, the DNA is synthesized in short (1-5 kb; see [Figure 35–16](#)) fragments, the so-called **Okazaki fragments**, so named after the scientist who discovered them. Several Okazaki fragments (up to 1000) must be sequentially synthesized for each replication fork. To ensure that this happens, the helicase acts on the lagging strand to unwind dsDNA in a 5' to 3' direction. The helicase associates with the primase to afford the latter proper access to the template. This allows the RNA primer to be made and, in turn, the polymerase to begin replicating the DNA. This is an important reaction sequence since DNA polymerases cannot initiate DNA synthesis de novo. The mobile complex between helicase and primase has been called a **primosome**. As the synthesis of an Okazaki fragment is completed and the polymerase is released, a new primer has been synthesized. The same polymerase molecule remains associated with the replication fork and proceeds to synthesize the next Okazaki fragment.

The DNA Polymerase Complex

A number of different DNA polymerase molecules engage in DNA replication. These share three important properties: (1) **chain elongation**, (2) **processivity**, and (3) **proofreading**. Chain elongation accounts for the rate (in **nucleotides per second; nt/s**) at which polymerization occurs. Processivity is an expression of the number of nucleotides added to the nascent chain before the polymerase disengages from the template. The proofreading function identifies copying errors and corrects them. In *E. coli*, DNA polymerase III (pol III) functions at the replication fork. Of all polymerases, it catalyzes the highest rate of chain elongation and is the

most processive. It is capable of polymerizing 0.5 Mb of DNA during one cycle on the leading strand. Pol III is a large (>1 MDa), multisubunit protein complex in *E. coli*. DNA pol III associates with the two identical β subunits of the DNA sliding “clamp”; this association dramatically increases pol III-DNA complex stability, processivity (100 to >50,000 nucleotides) and rate of chain elongation (20-50 nt/s) generating the high degree of processivity the enzyme exhibits.

Polymerase I (pol I) and II (pol II) are mostly involved in proofreading and DNA repair. Eukaryotic cells have counterparts for each of these enzymes plus a large number of additional DNA polymerases primarily involved in DNA repair. A comparison is shown in **Table 35–6**.

TABLE 35–6 A Comparison of Prokaryotic and Eukaryotic DNA Polymerases

<i>E coli</i>	Eukaryotic	Function
I		Gap filling following DNA replication, repair, and recombination
II		DNA proofreading and repair
	β	DNA repair
	γ	Mitochondrial DNA synthesis
III	ϵ	Processive, leading strand synthesis
DnaG	α	Primase
	δ	Processive, lagging strand synthesis

In mammalian cells, the polymerase is capable of polymerizing at a rate that is somewhat slower than the rate of polymerization of deoxynucleotides by the bacterial DNA polymerase complex. This reduced rate may result from interference by nucleosomes.

Initiation & Elongation of DNA Synthesis

The initiation of DNA synthesis (**Figure 35–14**) requires **priming** by a short length of RNA, about 10 to 200 nucleotides long. In *E. coli* this is catalyzed by dnaG (primase), in eukaryotes DNA Pol α synthesizes these RNA primers. The priming process involves nucleophilic attack by the 3'-hydroxyl group of the RNA primer on the phosphate of the first entering

deoxynucleoside triphosphate (N in [Figure 35–14](#)) with the splitting off of pyrophosphate; this transition to DNA synthesis is catalyzed by the appropriate DNA polymerases (DNA pol III in *E. coli*; DNA pol δ and ϵ in eukaryotes). The 3'-hydroxyl group of the recently attached deoxyribonucleoside monophosphate is then free to carry out a **nucleophilic attack** on the next entering deoxyribonucleoside triphosphate ($N + 1$ in [Figure 35–14](#)), again at its α phosphate moiety, with the splitting off of pyrophosphate. Of course, selection of the proper deoxyribonucleotide whose terminal 3'-hydroxyl group is to be attacked is dependent on proper base pairing with the other strand of the DNA molecule according to Watson and Crick base pairing rules ([Figure 35–15](#)). When an adenine deoxyribonucleoside monophosphoryl moiety is in the template position, a thymidine triphosphate will enter and its α phosphate will be attacked by the 3'-hydroxyl group of the deoxyribonucleoside monophosphoryl most recently added to the polymer. By this stepwise process, the template dictates which deoxyribonucleoside triphosphate is complementary and by hydrogen bonding holds it in place while the 3'-hydroxyl group of the growing strand attacks and incorporates the new nucleotide into the polymer. These segments of DNA attached to an RNA primer component are the Okazaki fragments ([Figure 35–16](#)). In mammals, after many Okazaki fragments are generated, the replication complex begins to remove the RNA primers, to fill in the gaps left by their removal with the proper base-paired deoxynucleotide, and then to seal the fragments of newly synthesized DNA by enzymes referred to as **DNA ligases**.

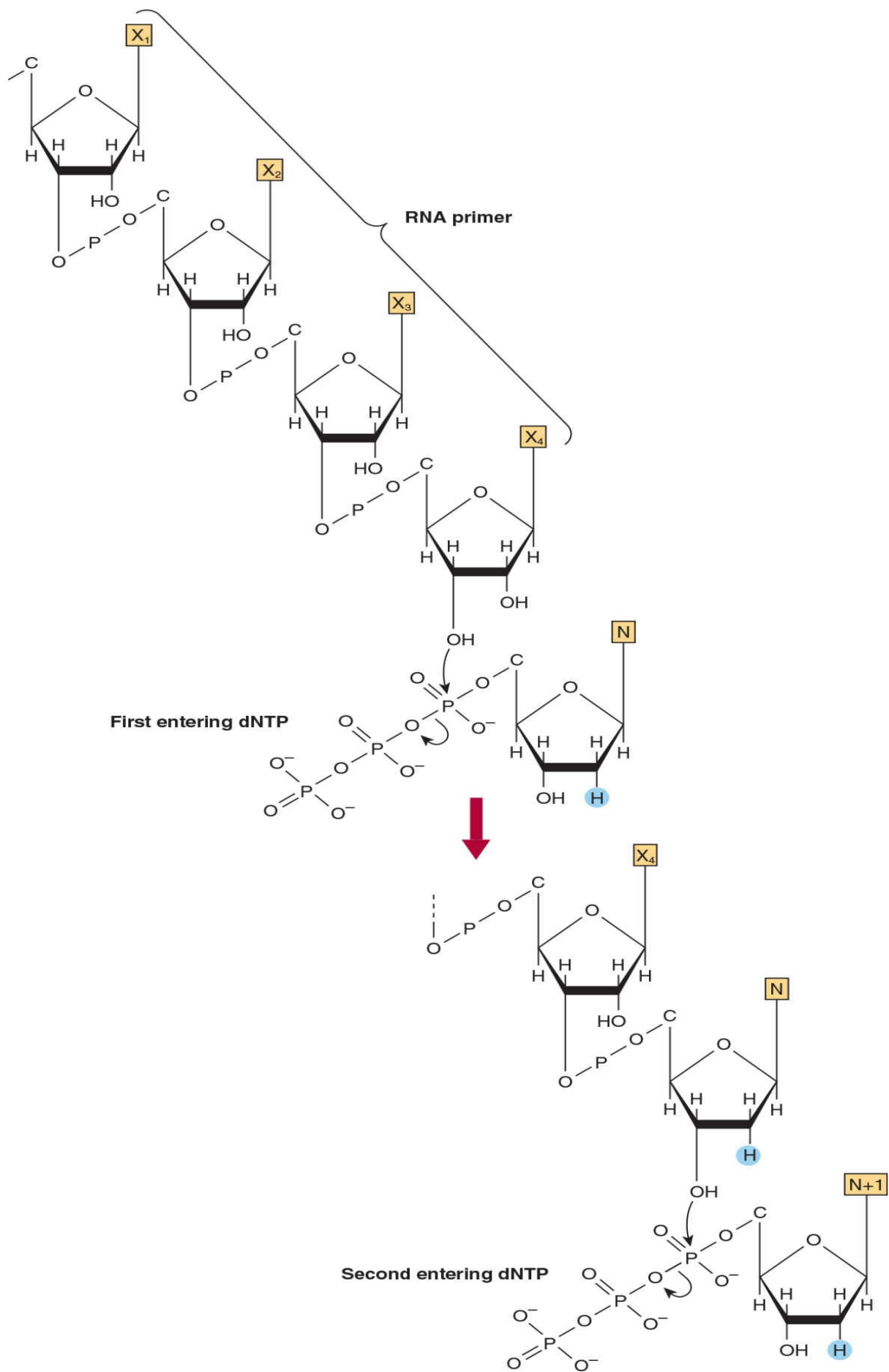

FIGURE 35–14 The initiation of DNA synthesis upon a primer of RNA and the subsequent attachment of the second deoxyribonucleoside triphosphate.

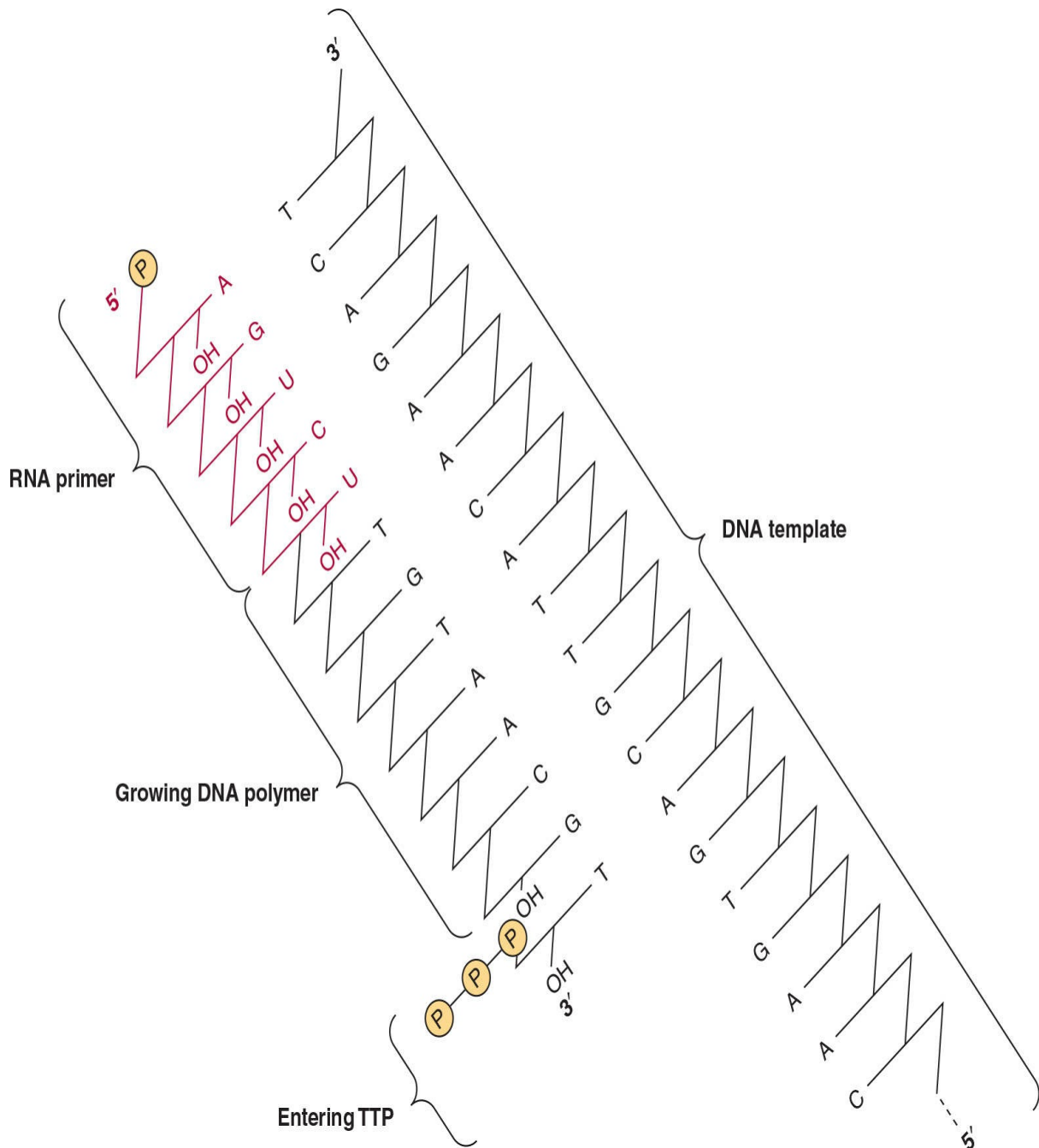

FIGURE 35–15 The RNA-primed synthesis of DNA demonstrating the template function of the complementary strand of parental DNA.

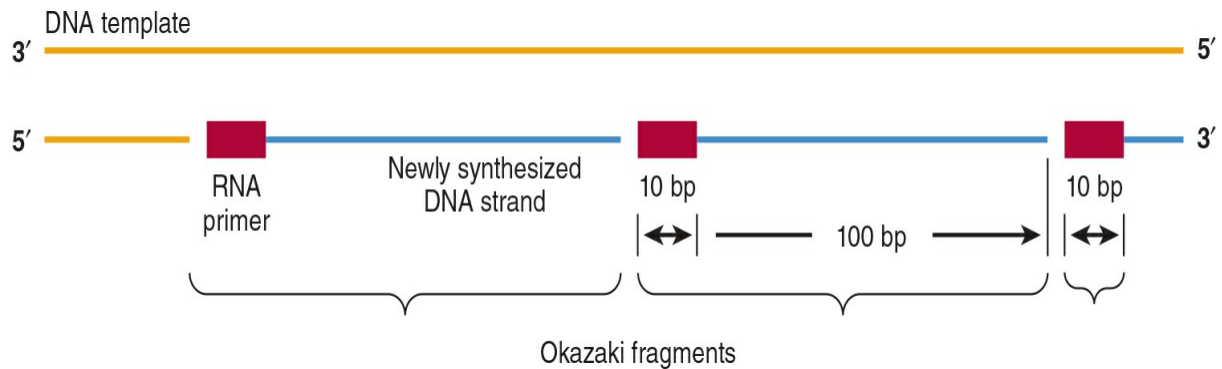

FIGURE 35–16 The discontinuous polymerization of deoxyribonucleotides on the lagging strand; formation of Okazaki fragments during lagging strand DNA synthesis is illustrated. Okazaki fragments are 100 to 250 nucleotides long in eukaryotes, 1000 to 2000 nucleotides in prokaryotes.

Replication Exhibits Polarity

As has already been noted, DNA molecules are double stranded and the two strands are antiparallel. The replication of DNA in prokaryotes and eukaryotes occurs on both strands simultaneously. However, an enzyme capable of polymerizing DNA in the 3' to 5' direction does not exist in any organism, so that both of the newly replicated DNA strands cannot grow in the same direction simultaneously. Nevertheless, in bacteria the same enzyme does replicate both strands at the same time (in eukaryotes pol ϵ and pol δ catalyze leading and lagging strand synthesis; see [Table 35–6](#)). The single enzyme replicates one strand (“leading strand”) in a continuous manner in the 5' to 3' direction, with the same overall forward direction. It replicates the other strand (“lagging strand”) discontinuously while polymerizing the nucleotides in short spurts of 150 to 250 nucleotides, again in the 5' to 3' direction, but at the same time it faces toward the back end of the preceding RNA primer rather than toward the unreplicated portion. This process of **semidiscontinuous DNA synthesis** is shown diagrammatically in [Figures 35–13](#) and [35–16](#).

Formation of Replication Bubbles

Replication of the circular bacterial chromosome, composed of roughly 5×10^6 bp of DNA proceeds from a single ori. This process is completed in about 30 minutes, a replication rate of 3×10^5 bp/min. The entire mammalian genome replicates in approximately 9 hours, the average period required for formation of a tetraploid genome from a diploid

genome in a replicating cell. If a mammalian genome (3×10^9 bp) replicated at the same rate as bacteria (ie, 3×10^5 bp/min) from but a single ori, replication would take over 150 hours! Metazoan organisms get around this problem using two strategies. First, replication is bidirectional. Second, replication proceeds from multiple origins in each chromosome (a total of as many as 100 in humans). Thus, replication occurs in both directions along all of the chromosomes, and both strands are replicated simultaneously. This replication process generates “**replication bubbles**” (Figure 35–17).

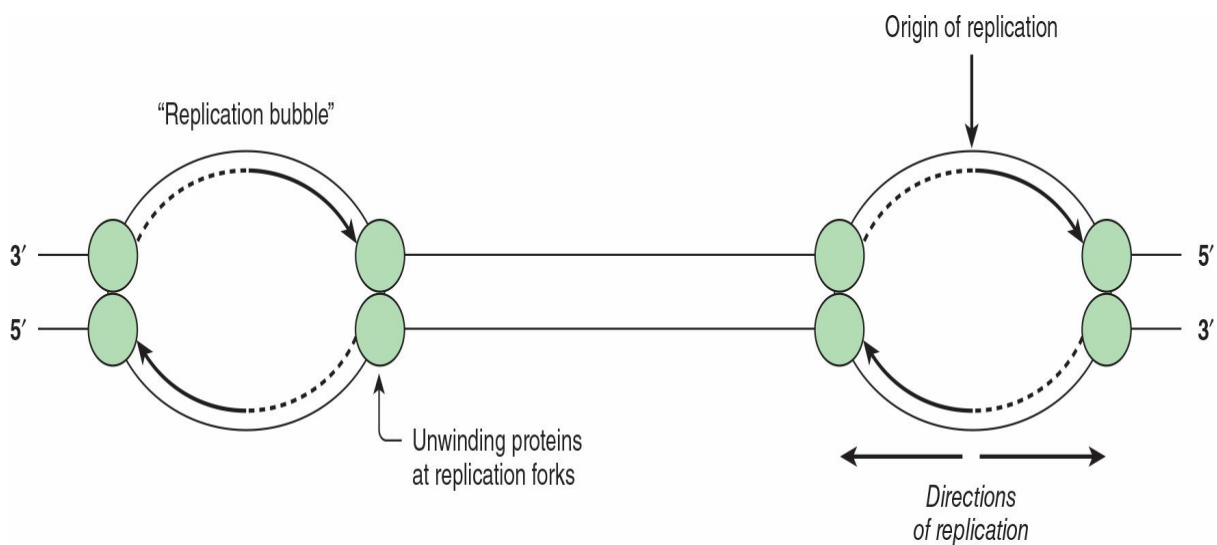

FIGURE 35–17 The generation of “replication bubbles” during the process of DNA synthesis. The bidirectional replication and the proposed positions of unwinding proteins at the replication forks are depicted.

The multiple ori sites that serve as origins for DNA replication in eukaryotes are poorly defined except in a few animal viruses and in yeast. However, it is clear that initiation is regulated both spatially and temporally, since clusters of adjacent sites initiate replication synchronously. Replication firing, or DNA replication initiation at a replicator/ori, is influenced by a number of distinct properties of chromatin structure that are just beginning to be understood. It is clear, however, that there are more replicators and excess ORC than needed to replicate the mammalian genome within the time of a typical S phase. Therefore, mechanisms for controlling the excess ORC-bound replicators must exist. Understanding the control of the formation and firing of replication complexes is one of the major challenges in this field.

During the replication of DNA, there must be a separation of the two

strands to allow each to serve as a template by hydrogen bonding its nucleotide bases to the incoming deoxynucleoside triphosphate. The separation of the DNA strands is promoted by **SSBs** in *E. coli*, and a protein termed **replication protein A (RPA)** in eukaryotes. These molecules stabilize the single-stranded structure as the replication fork progresses. The stabilizing proteins bind cooperatively and stoichiometrically to the single strands without interfering with the abilities of the nucleotides to serve as templates (Figure 35–13). In addition to separating the two strands of the double helix, there must be an unwinding of the molecule (once every 10 nucleotide pairs) to allow strand separation. The hexameric DNAB protein complex unwinds DNA in *E. coli*, whereas the hexameric MCM complex unwinds eukaryotic DNA. This unwinding happens in segments adjacent to the replication bubble. To counteract this unwinding, there are multiple “swivels” interspersed in the DNA molecules of all organisms. The swivel function is provided by specific enzymes that introduce “**nicks**” in one strand of the unwinding **double helix**, thereby allowing the unwinding process to proceed. The nicks are quickly resealed without requiring energy input, because of the formation of a high-energy covalent bond between the nicked phosphodiester backbone and the nicking-sealing enzyme. The nicking-resealing enzymes are called **DNA topoisomerases**. This process is depicted diagrammatically in Figure 35–18 and there compared with the ATP-dependent resealing carried out by the DNA ligases (see Table 39–2). Topoisomerases are also capable of unwinding supercoiled DNA. Supercoiled DNA is a higher-ordered structure occurring in circular DNA molecules wrapped around a core, as depicted in Figures 35–2 and 35–19.

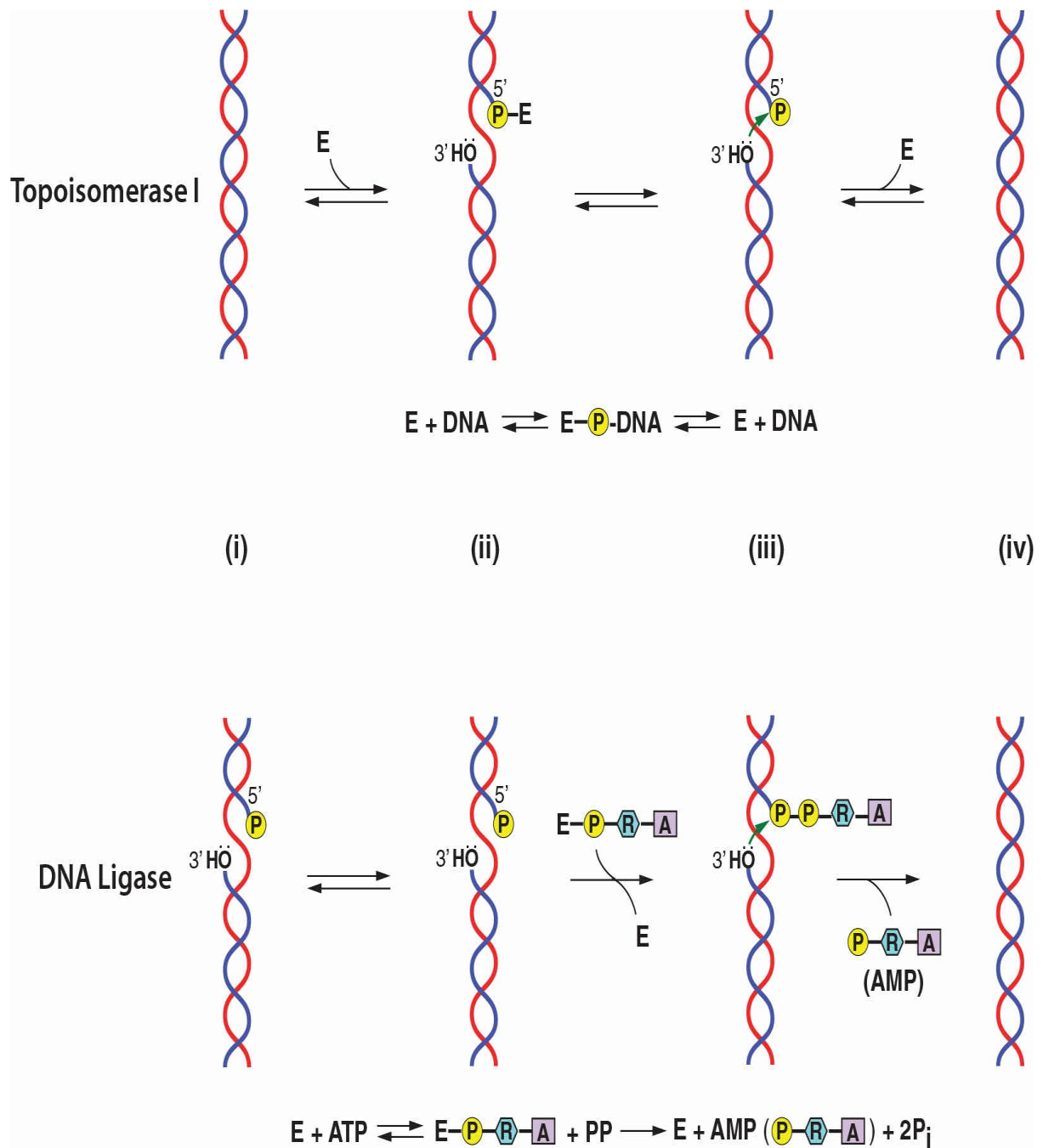

FIGURE 35–18 Two types of DNA nick-sealing reactions. Two forms of nick sealing are represented: ATP-independent (top) and ATP-dependent (bottom). Nick sealing processes proceeds in multiple steps: (i)-substrate to → (iv)-product. The enzymes involved are signified by E (top, bottom), while small molecule reactants and products are indicated as Phosphate (P); Pyrophosphate (PP), inorganic Phosphate (Pi) generated from PP by the action of ubiquitous pyrophosphatases, Ribose (R), and Adenine (A). The nick-sealing reaction at the top is catalyzed by DNA topoisomerase I and is ATP-energy independent because the energy for reformation of DNA phosphodiester bonds is stored within the covalent

attachment of topoisomerase I to DNA (P-E; top; step ii). Bond reformation is accomplished by the nucleophilic attack of the 3' OH group (green arrow, step iii) to the phosphate of the P-E complex. This reaction releases free topoisomerase I (E) and intact double stranded DNA (step iv). The overall enzyme reaction is schematized at the bottom of the figure (steps I → iv). The nick-sealing reaction catalyzed by DNA ligase (bottom) repairs single strand DNA breaks in the phosphodiester backbone that are a result of DNA replication and/or DNA repair (step i; bottom). The complete DNA ligase reaction requires hydrolysis of two of the high-energy phosphodiester bonds of ATP. The overall reaction scheme of DNA ligase nick-sealing from nick, to enzyme-DNA binding, to enzyme activation that releases Pyrophosphate (PP) to release of free enzyme, AMP and intact DNA is depicted (bottom; as noted in the text, PP is rapidly converted to 2 moles of Pi by the action of ubiquitous pyrophosphatases). The activated ligase (E-P-R-A) reacts with the 5' P at the nick site to form a transient DNA-P-P-R-A complex (note: P-R-A = AMP) that liberates free DNA Ligase Enzyme (E). Nucleophilic attack of the free 3' OH group with the 5' P of the DNA-5'P-AMP complex (green arrow, step iii) reseals the nick and liberates AMP. The overall enzyme reaction converting nicked DNA to intact DNA ($E + ATP \rightarrow E + AMP + 2Pi$) is schematized at the bottom of the figure (steps I → iv).

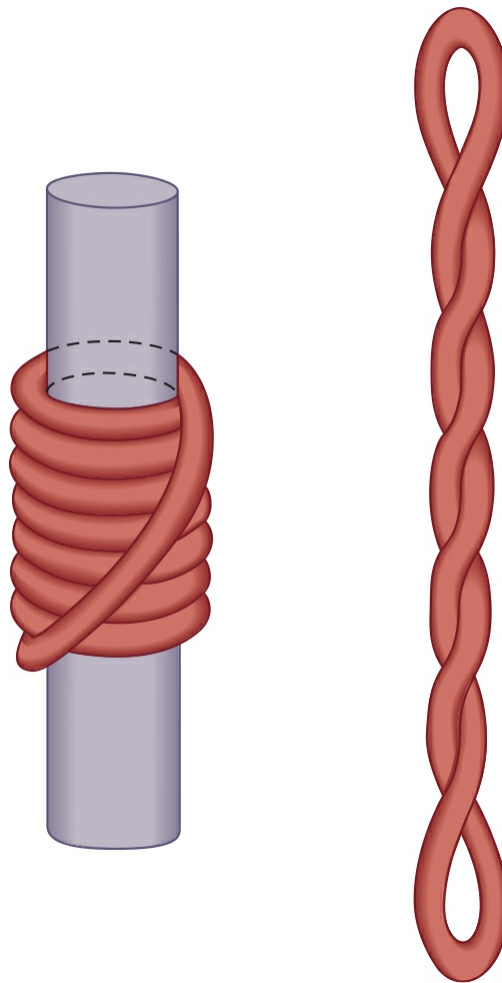

FIGURE 35–19 Supercoiling of DNA. A left-handed toroidal (solenoidal) supercoil, at left, will convert to a right-handed interwound supercoil, at right, when the cylindrical core is removed. Such a transition is analogous to that which occurs when nucleosomes are disrupted by the high salt extraction of histones from chromatin.

There exists in one species of animal viruses (retroviruses) a class of enzymes capable of synthesizing a single-stranded and then a dsDNA molecule from a single-stranded RNA template. This polymerase, termed RNA-dependent DNA polymerase, or “**reverse transcriptase**,” first synthesizes a DNA–RNA hybrid molecule utilizing the RNA genome as a template. A specific virus-encoded nuclease, **RNase H**, degrades the hybridized template RNA strand. Subsequently, the remaining DNA strand in turn serves as a template to form a dsDNA molecule containing the genetic information originally present in the RNA genome of the animal virus. The resulting dsDNA can then integrate into the host genome.

Reconstitution of Chromatin Structure

There is evidence that nuclear organization and chromatin structure are involved in determining the regulation and initiation of DNA synthesis. As noted above, the rate of polymerization in eukaryotic cells, which have chromatin and nucleosomes, is slower than that in prokaryotic cells, which lack canonical nucleosomes. It is also clear that chromatin structure must be reformed after replication. Newly replicated DNA is rapidly assembled into nucleosomes, and the preexisting and newly assembled histone octamers are randomly distributed to each arm of the replication fork. These reactions are facilitated through the actions of histone chaperone proteins working in concert with chromatin assembly and remodeling complexes.

DNA Synthesis Occurs During the S Phase of the Cell Cycle

In eukaryotic cells, including human cells, the replication of the DNA genome occurs only at a specified time during the life span of the cell. This period is referred to as the **synthetic or S phase**. This is usually temporally separated from the **mitotic, or M phase**, by nonsynthetic periods referred to as **gap 1 (G_1)** and **gap 2 (G_2) phases**, occurring before and after the S phase, respectively (**Figure 35–20**). Among other things, the cell prepares for DNA synthesis in G_1 , and for mitosis in G_2 . The cell regulates DNA synthesis by allowing it to occur only once per cell cycle, and only during S phase, in cells preparing to divide by a mitotic process.

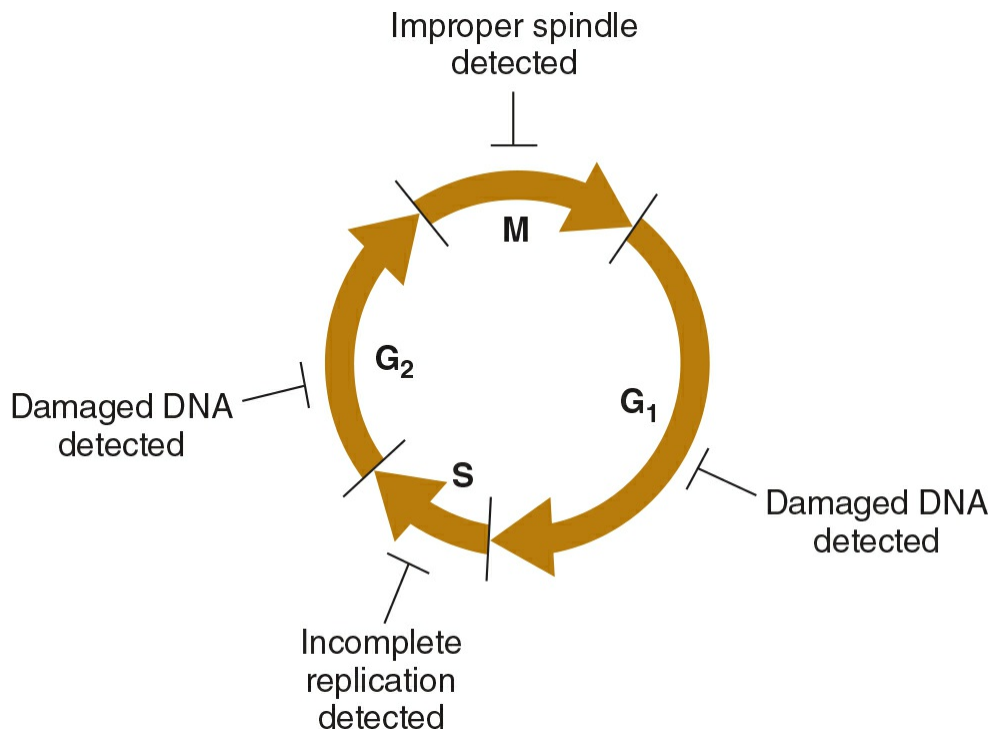

FIGURE 35–20 Progress through the mammalian cell cycle is continuously monitored via multiple cell-cycle checkpoints. DNA, chromosome, and chromosome segregation integrity are continuously monitored throughout the cell cycle. If DNA damage is detected in either the G₁ or the G₂ phase of the cell cycle, if the genome is incompletely replicated, or if normal chromosome segregation machinery is incomplete (ie, a defective spindle), cells will not progress through the phase of the cycle in which defects are detected. In some cases, if the damage cannot be repaired, such cells undergo programmed cell death (apoptosis). Note that cells can reversibly leave the cell cycle during G₁ entering a nonreplicative state termed G₀ (not shown, but see [Figure 9–8](#)). When appropriate signals/conditions occur, cells reenter G₁ and progress normally through the cell cycle as depicted.

All eukaryotic cells have gene products that govern the transition from one phase of the cell cycle to another. The **cyclins** are a family of proteins whose concentration increases and decreases at specific times, that is, “cycle” during the cell cycle—thus their name. The cyclins thus activate, at the appropriate time, different **cyclin-dependent protein kinases (CDKs)** that phosphorylate substrates essential for progression through the cell cycle ([Figure 35–21](#)). For example, cyclin D levels rise in late G₁ phase and allow progression beyond the **start (yeast)** or **restriction point (mammals)**, the point beyond which cells irrevocably proceed into the S

or DNA synthesis phase.

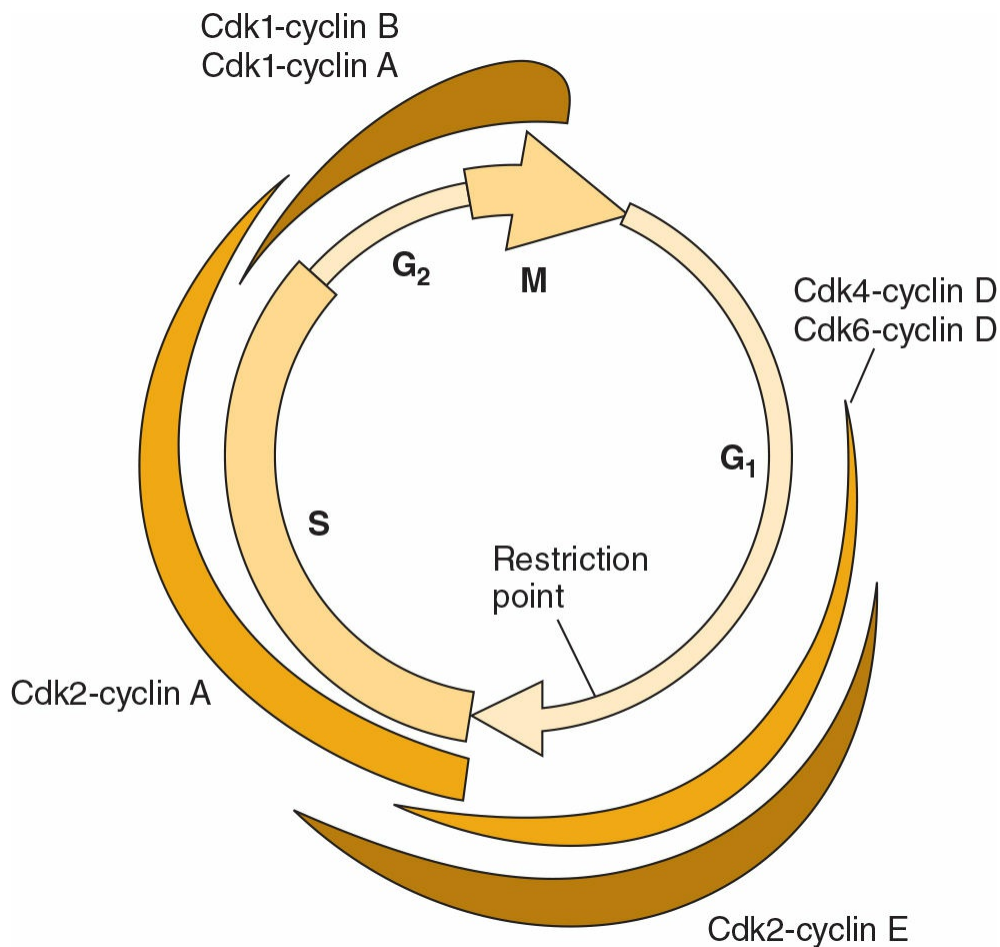

FIGURE 35–21 Schematic illustration of the points during the mammalian cell cycle during which the indicated cyclins and cyclin-dependent kinases are activated. The thickness of the various colored lines is indicative of the extent of activity.

The D cyclins activate CDK4 and CDK6. These two kinases are also synthesized during G₁ in cells undergoing active division. The D cyclins and CDK4 and CDK6 are nuclear proteins that assemble as a complex in late G₁ phase. The cyclin–CDK complex is now an active serine–threonine protein kinase. One substrate for this kinase is the retinoblastoma (Rb) protein. Rb is a cell-cycle regulator because it binds to and inactivates a transcription factor (E2F) necessary for the transcription of certain genes (histone genes, DNA replication proteins, etc) needed for progression from G₁ to S phase. The phosphorylation of Rb by CDK4 or CDK6 results in the release of E2F from Rb-mediated transcription repression—thus, gene transcription activation ensues and cell-cycle progression takes place.

Other cyclins and CDKs are involved in different aspects of cell-cycle progression (**Table 35–7**). Cyclin E and CDK2 form a complex in late G_1 . Cyclin E is rapidly degraded, and the released CDK2 then forms a complex with cyclin A. This sequence is necessary for the initiation of DNA synthesis in S phase. A complex between cyclin B and CDK1 is rate-limiting for the G_2 /M transition in eukaryotic cells.

TABLE 35–7 Cyclins and Cyclin-Dependent Kinases Involved in Cell-Cycle Progression

Cyclin	Kinase	Function
D	CDK4, CDK6	Progression past restriction point at G_1 /S boundary
E, A	CDK2	Initiation of DNA synthesis in early S phase
B	CDK1	Transition from G_2 to M

Many of the cancer-causing viruses (oncoviruses) and cancer-inducing genes (oncogenes) are capable of alleviating or disrupting the restriction that normally controls the entry of mammalian cells from G_1 into the S phase. From the foregoing, one might have surmised that excessive production of a cyclin, loss of a specific CDK inhibitor (see below), or production or activation of a cyclin/CDK at an inappropriate time might result in abnormal or unrestrained cell division. Similarly, the oncoproteins (or transforming proteins) produced by several DNA viruses target the Rb transcription repressor for inactivation, inducing cell division inappropriately, while inactivation of Rb, itself a tumor suppressor gene, leads to uncontrolled cell growth and tumor formation.

During the S phase, mammalian cells contain greater quantities of DNA polymerase than during the nonsynthetic phases of the cell cycle. Furthermore, those enzymes responsible for formation of the substrates for DNA synthesis—that is, deoxyribonucleoside triphosphates—are also increased in activity, and their expression drops following the synthetic phase until the reappearance of the signal for renewed DNA synthesis. During the S phase, the **nuclear DNA is completely replicated once and only once**. Once chromatin has been replicated, it is marked so as to prevent its further replication until it again passes through mitosis. This process is termed replication licensing. The molecular mechanisms for this

phenomenon in human cells involves dissociation and/or cyclin–CDK phosphorylation and subsequent degradation of several origin binding proteins that play critical roles in replication complex formation. Consequently, origins fire only once per cell cycle.

In general, a given pair of chromosomes will replicate simultaneously and within a fixed portion of the S phase upon every replication. On a chromosome, clusters of replication units replicate coordinately. The nature of the signals that regulate DNA synthesis at these levels is unknown, but the regulation does appear to be an intrinsic property of each individual chromosome that is mediated by the several replication origins contained therein.

All Organisms Contain Elaborate Evolutionarily Conserved Mechanisms to Repair Damaged DNA

Repair of damaged DNA is critical for maintaining genomic integrity and thereby preventing the propagation of mutations, either horizontally (somatic cells), or vertically (germ cells). DNA is subjected to a huge array of chemical, physical, and biologic assaults on a daily basis (**Table 35–8**), hence efficient recognition and repair of DNA lesions is essential. Consequently, eukaryotic cells contain five major DNA repair pathways, each of which contain multiple, sometimes shared proteins; these DNA repair proteins typically have orthologues in prokaryotes. The mechanisms of DNA repair include **nucleotide excision repair (NER)**; **mismatch repair (MMR)**; **base excision repair (BER)**; **homologous recombination (HR)**; and **nonhomologous end-joining (NHEJ)** repair pathways (**Figure 35–22**). The experiment of testing the importance of many of these DNA repair proteins to human biology has been performed by nature—mutations in a large number of these genes lead to human disease (**Table 35–9**). Moreover, systematic gene-directed “knockout” experiments (see **Chapter 39**) with laboratory mice and cells in culture have clearly ascribed critical gene integrity maintenance functions to these genes as well. In these genetic studies, it was observed that indeed targeted mutations within these genes induce defects in DNA repair while often also dramatically increasing susceptibility to cancer.

TABLE 35–8 Types of Damage to DNA

I. Single-base alteration
A. Depurination
B. Deamination of cytosine to uracil
C. Deamination of adenine to hypoxanthine
D. Alkylation of base
E. Base-analog incorporation
II. Two-base alteration
A. UV light-induced thymine–thymine (pyrimidine) dimer
B. Bifunctional alkylating agent cross-linkage
III. Chain breaks
A. Ionizing radiation
B. Radioactive disintegration of backbone element
C. Oxidative free-radical formation
IV. Cross-linkage
A. Between bases in same or opposite strands
B. Between DNA and protein molecules (eg, histones)

TABLE 35–9 Human Diseases of DNA Damage Repair

<p>Defective Nonhomologous End-Joining Repair (NHEJ) Severe combined immunodeficiency disease (SCID) Radiation-sensitive severe combined immunodeficiency disease (RS-SCID)</p>
<p>Defective Homologous Repair (HR) AT-like disorder (ATLD) Nijmegen breakage syndrome (NBS) Bloom syndrome (BS) Werner syndrome (WS) Rothmund-Thomson syndrome (RTS) Breast cancer susceptibility 1 and 2 (BRCA1, BRCA2)</p>
<p>Defective DNA Nucleotide Excision Repair (NER) Xeroderma pigmentosum (XP) Cockayne syndrome (CS) Trichothiodystrophy (TTD)</p>
<p>Defective DNA Base Excision Repair (BER) MUTYH-associated polyposis (MAP)</p>
<p>Defective DNA Mismatch Repair (MMR) Hereditary nonpolyposis colorectal cancer (HNPCC)</p>

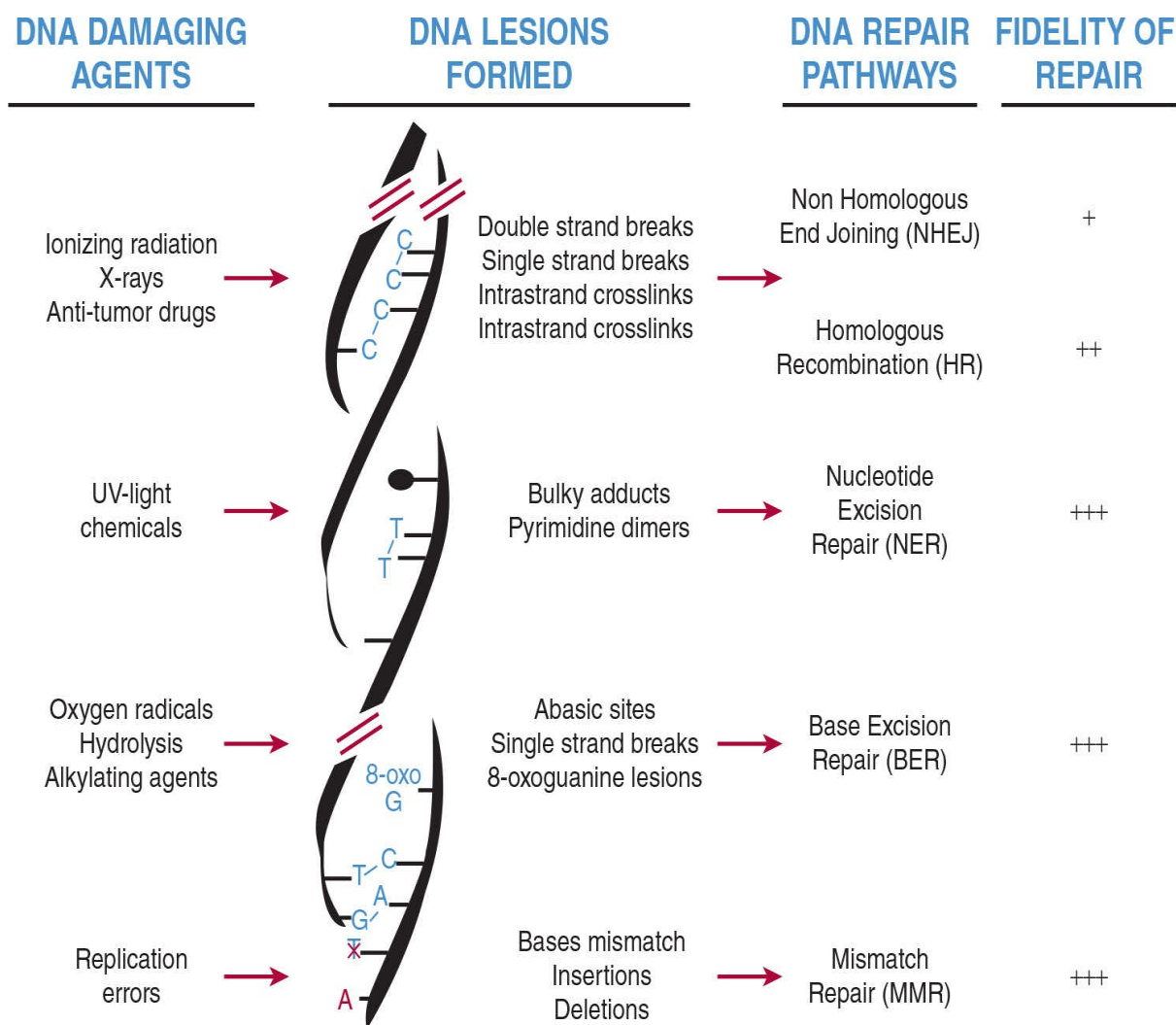

FIGURE 35–22 Mammals use multiple DNA repair pathways of variable accuracy to repair the myriad forms of DNA damage genomic DNA is subjected to. Listed are the major types of DNA damaging agents, the DNA lesions so formed (schematized and listed), the DNA repair pathway responsible for repairing the different lesions, and the relative fidelity of these pathways. (Modified, with permission, from: “DNA-damage response in tissue-specific and cancer stem cells” *Cell Stem Cell* 8:16–29 (2011) copyright © 2011 Elsevier Inc.

One of the most intensively studied mechanisms of DNA repair is the mechanism used to repair DNA **double-strand breaks (DSBs)**; these will be discussed in some detail here. There are two pathways, **HR** and **NHEJ**, that eukaryotic cells utilize to remove DSBs. The choice between the two depends on the phase of the cell cycle (Figures 35–20 and 35–21) and the exact type of DSB breaks to be repaired (Table 35–8). During the G_0/G_1 phases of the cell cycle, DSBs are corrected by the NHEJ pathway,

whereas during S, G_2 , and M phases of the cell cycle HR is utilized. All steps of DNA damage repair are catalyzed by evolutionarily conserved molecules, which include **DNA damage sensors, transducers, and damage repair mediators**. Collectively, these cascades of proteins participate in the cellular response to DNA damage. Importantly, the ultimate cellular outcomes of DNA damage, and cellular attempts to repair DNA damage, range from **cell-cycle delay** to allow for DNA repair, to **cell-cycle arrest**, to **apoptosis** or **senescence** (**Figure 35–23**; and further detail below). The molecules involved in these complex and highly integrated processes range from damage-specific histone modifications (ie, dimethylated lysine 20 histone H4; H4K20me2) and incorporation of histone isotype variants such as histone **H2AX** into nucleosomes at the site of DNA damage (**Table 35–1**), poly ADP ribose polymerase (**PARP**), the MRN protein complex (Mre11-Rad50-NBS1 subunits); to DNA damage-activated kinase recognition/signaling proteins (**ATM** [ataxia telangiectasia, mutated] and ATM-related kinase (**ATR**), the multisubunit DNA-dependent protein kinase [**DNA-PK and Ku70/80**], and checkpoint kinases 1 and 2 [**CHK1, CHK2**]). These multiple kinases phosphorylate and consequently modulate the activities of dozens of proteins, such as numerous DNA repair, checkpoint control, and cell-cycle control proteins like CDC25A, B, C, Wee1, p21, p16, and p19 (all cyclin–CDK regulators [see **Figure 9–8**; and below]; various exo- and endonucleases; DNA single-strand-specific DNA-binding proteins [RPA]; PCNA and specific DNA polymerases [DNA pol δ and η]). Several of these (types of) proteins/enzymes have been discussed above in the context of DNA replication. DNA repair and its relationship to cell-cycle control are very active areas of research given their central roles in cell biology and potential for generating and preventing cancer.

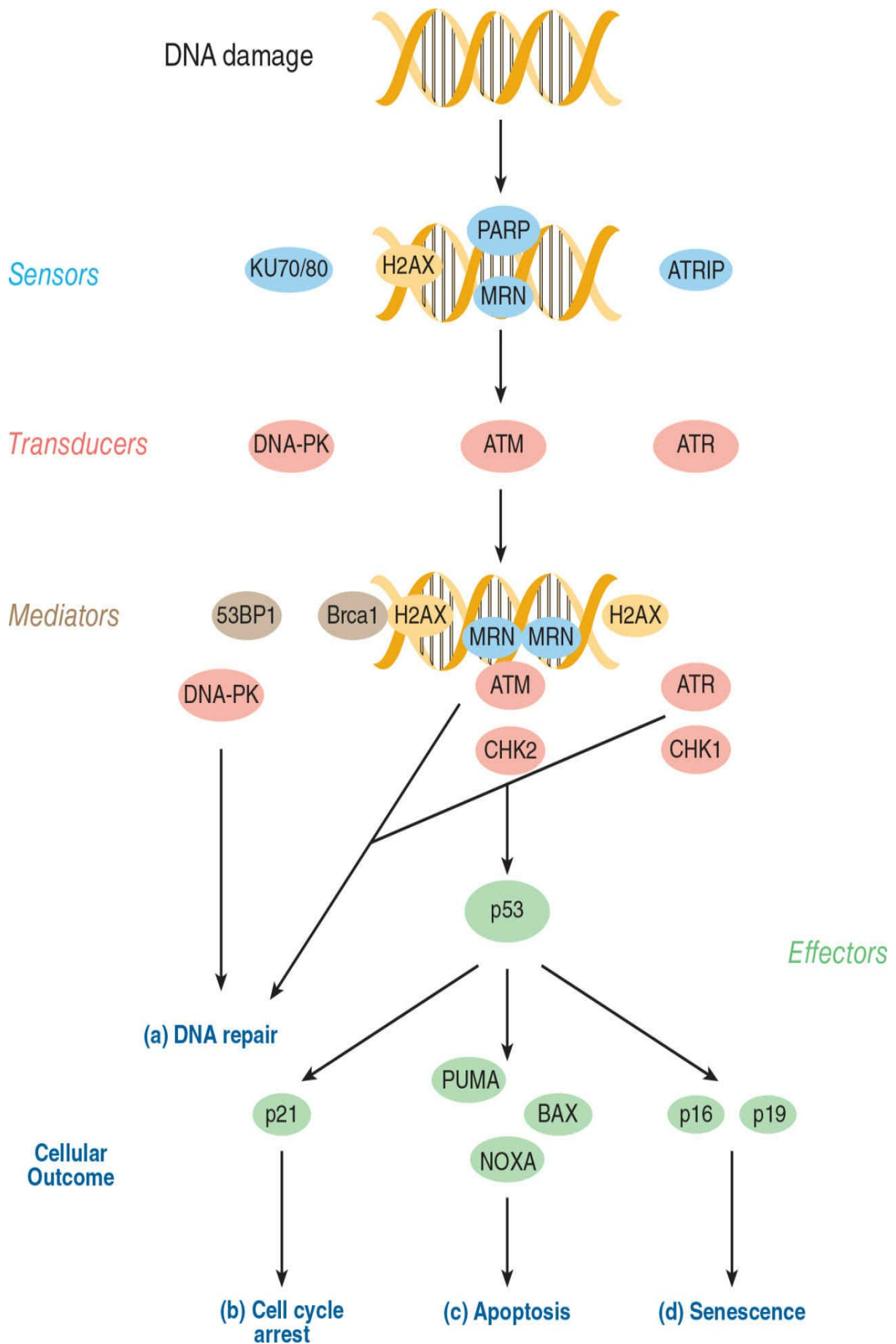

FIGURE 35–23 The multistep mechanism of DNA double-strand break repair. Shown top to bottom are the proteins (protein complexes) that identify DSBs in genomic DNA (sensors), transduce, and amplify the recognized DNA damage (transducers and mediators), as well as the molecules that dictate the ultimate outcomes of the DNA damage response (effectors). Damaged DNA can be (a) repaired directly (DNA repair), or, via p53-mediated pathways and depending upon the severity of DNA damage and p53-activated genes induced, (b), cells can be arrested in the cell cycle by p21/WAF1 the potent CDK–cyclin complex inhibitor to allow time for extensively damaged DNA to be repaired, or (c), and (d) if the extent of DNA damage is too great to repair, cells can either apoptose or senesce; both of these processes prevent the cell containing such damaged DNA from ever dividing and hence inducing cancer or other deleterious biologic outcomes. (Based on: “DNA-damage response in tissue-specific and cancer stem cells” *Cell Stem Cell* 8:16–29 (2011) copyright © 2011 Elsevier Inc.)

DNA & Chromosome Integrity Is Monitored Throughout the Cell Cycle

Given the importance of normal DNA and chromosome function to survival, it is not surprising that eukaryotic cells have developed elaborate mechanisms to monitor the integrity of the genetic material. As detailed above, a number of complex multisubunit enzyme systems have evolved to repair damaged DNA at the nucleotide sequence level. Similarly, DNA mishaps at the chromosome level are also monitored and repaired. As shown in [Figure 35–20](#), both DNA and chromosomal integrity are continuously monitored throughout the cell cycle. The four specific steps at which this monitoring occurs have been termed **checkpoint controls**. If problems are detected at any of these checkpoints, progression through the cycle is interrupted and transit through the cell cycle is halted until the damage is repaired. The molecular mechanisms underlying detection of DNA damage during the G_1 and G_2 phases of the cycle are understood better than those operative during S and M phases.

The **tumor suppressor p53**, a protein of apparent MW 53 kDa on SDS-PAGE, plays a key role in both G_1 and G_2 checkpoint control. Normally a very unstable protein, p53 is a DNA-binding transcription factor, **one of a family of related proteins** (ie, **p53**, **p63**, and **p73**) that is somehow stabilized in response to DNA damage, perhaps by direct p53-

DNA interactions. Like the histones discussed above, p53 is subject to a panoply of regulatory PTMs, all of which likely modify its multiple biologic activities. Increased levels of p53 activate transcription of an ensemble of genes that collectively serve to delay transit through the cycle. One of these induced proteins, **p21, is a potent CDK–cyclin inhibitor (CKI)** that is capable of efficiently inhibiting the action of all CDKs. Clearly, inhibition of CDKs will halt progression through the cell cycle (see [Figures 35–20](#) and [35–21](#)). If DNA damage is too extensive to repair, the affected cells undergo **apoptosis (programmed cell death)** in a p53-dependent fashion. In this case, p53 induces the activation of a collection of genes that induce apoptosis. Cells lacking functional p53 fail to undergo apoptosis in response to high levels of radiation or DNA-active chemotherapeutic agents. It may come as no surprise, then, that *p53* is one of the most frequently mutated genes in human cancers (see [Chapter 56](#)). Indeed, recent genomic sequencing studies of a multitude of tumor DNA samples suggest that over 80% of human cancers carry p53 loss-of-function mutations. Additional research into the mechanisms of checkpoint control will prove invaluable for the development of effective anticancer therapeutic options.

SUMMARY

- DNA in eukaryotic cells is associated with a variety of proteins, resulting in a structure called chromatin.
- Much of the DNA is associated with histone proteins to form a structure called the nucleosome. Nucleosomes are composed of an octamer of histones around which about 150 bp of DNA is wrapped.
- Histones are subject to an extensive array of dynamic covalent modifications that have important regulatory consequences.
- Nucleosomes and higher-order structures formed from them serve to compact the DNA.
- DNA in transcriptionally active regions is relatively more sensitive to nuclease attack *in vitro*; some regions, so-called hypersensitive sites are exceptionally sensitive and are often found to contain transcription control sites.
- Highly transcriptionally active DNA (genes) is often clustered in regions of each chromosome. Within these regions, genes may be separated by inactive DNA in nucleosomal structures. In many eukaryotic transcription units (ie, the portion of a gene that is copied by RNA polymerase) often consists of coding regions of DNA (exons)

interrupted by intervening sequences of noncoding DNA (introns). This is particularly true for mRNA-encoding genes.

- After transcription, during RNA processing, introns are removed and the exons are ligated together to form the mature mRNA that appears in the cytoplasm; this process is termed RNA splicing.
- DNA in each chromosome is exactly replicated according to the rules of base pairing during the S phase of the cell cycle.
- Each strand of the double helix is replicated simultaneously but by somewhat different mechanisms. A complex of proteins, including DNA polymerase, replicates the leading strand continuously in the 5' to 3' direction. The lagging strand is replicated discontinuously, in short pieces of 100 to 250 nucleotides by DNA polymerase synthesizing in the 5' → 3' direction.
- DNA replication is initiated at special sites termed origins to generate replication bubbles. Each eukaryotic chromosome contains multiple origins. The entire process takes about 9 hours in a typical human cell and only occurs during the S phase of the cell cycle.
- A variety of mechanisms that employ different enzyme systems repair damaged cellular DNA after exposure of cells to chemical and physical mutagens.
- Normal cells containing DNA that cannot be repaired undergo programmed cell death.

REFERENCES

- Braunschweig U, Gueroussov S, Plocik AM, Graveley BR, Blencowe BJ: Dynamic integration of splicing within gene regulatory pathways. *Cell* 2013;152:1252.
- Burgers PMJ, Kunkel TA: Eukaryotic DNA replication fork. *Annu Rev Biochem* 2017;86:417.
- Chabot B, Shkreta L: Defective control of pre-messenger RNA splicing in human disease. *J Cell Biol* 2016;212:13.
- Dominguez-Brauer C, Thu KL, Mason, JL, Blaser H, Bray MR, Mak TM: Targeting mitosis in cancer: emerging strategies. *Mol Cell* 2015;60:524.
- Hills SA, Diffley JFX: DNA replication and oncogene-induced replicative stress. *Curr Biol* 2014;24:R435.
- Kunkel TA: Celebrating DNA's repair crew. *Cell* 2015;163:1301.
- Naftelberg S, Schor IE, Ast G, Kornblihtt AR: Regulation of alternative

- splicing through coupling with transcription and chromatin structure. *Ann Rev Biochem* 2015;84:165.
- Neupert W: Mitochondrial gene expression: a playground of evolutionary tinkering. *Ann Rev Biochem* 2016;85:65.
- Pozo K, Bibb JA: The Emerging role of Cdk5 in cancer. *Trends Cancer* 2016;2:606.
- Sabari BR, Zhang D, Allis CD, Zhao Y: Metabolic regulation of gene expression through histone acylations. *Nat Rev Mol Cell Biol* 2017;18:90.
- Salazar-Roa M, Malumbres M: Fueling the cell division cycle. *Trends Cell Biol* 2017;27:69.
- Smith OK, Aladjem MI: Chromatin structure and replication origins: determinants of chromosome replication and nuclear organization. *J Mol Biol* 2014;426:3330.
- Tang YC, Amon A: Gene copy-number alterations: a cost-benefit analysis. *Cell* 2013;152:394.

*So far as possible, the discussion in this chapter and in [Chapters 36, 37, and 38](#) will pertain to mammalian organisms, which are, of course, among the higher eukaryotes. At times, it will be necessary to refer to observations in prokaryotic organisms such as bacteria and viruses, or lower eukaryotic model systems such as *Drosophila*, *Caenorhabditis elegans*, or, yeast, *Saccharomyces cerevisiae*. However, in such cases the information will be of a kind that can be readily extrapolated to mammalian organisms.

RNA Synthesis, Processing, & Modification

P. Anthony Weil, PhD

OBJECTIVES

After studying this chapter, you should be able to:

- Describe the molecules involved and the mechanism of RNA synthesis.
- Explain how eukaryotic DNA-dependent RNA polymerases, in collaboration with an array of specific accessory factors, can differentially transcribe genomic DNA to produce specific messenger RNA (mRNA) precursor molecules.
- Describe the structure of eukaryotic mRNA precursors, which are highly modified internally and at both termini.
- Appreciate the fact that the majority of mammalian mRNA-encoding genes are interrupted by multiple nonprotein coding sequences termed introns, which are interspersed between protein coding regions termed exons.
- Explain that since intron RNA does not encode protein, the intronic RNA must be specifically and accurately removed in order to generate functional mRNAs from the mRNA precursor

molecules in a series of precise molecular events termed RNA splicing.

- Explain the steps and molecules that catalyze mRNA splicing, a process that converts the end-modified precursor molecules into mRNAs that are functional for translation.

BIOMEDICAL IMPORTANCE

The synthesis of an RNA molecule from eukaryotic DNA is a complex process involving one of the group of DNA-dependent RNA polymerase enzymes and a number of associated proteins. The general steps required to synthesize the primary transcript are initiation, elongation, and termination. Most is known about initiation. A number of DNA regions (generally located upstream from the initiation site) and protein factors that bind to these sequences to regulate the initiation of transcription have been identified. Certain RNAs—mRNAs in particular—have very different life spans in a cell. The RNA molecules synthesized in mammalian cells are made as precursor molecules that have to be processed into mature, active RNA. It is important to understand the basic principles of messenger RNA (mRNA) synthesis and metabolism, for modulation of this process results in altered rates of protein synthesis and thus a variety of cellular phenotypic changes. This is how all organisms adapt to changes of environment. It is also how differentiated cell structures and functions are established and maintained. Errors or changes in synthesis, processing, splicing, stability, or function of mRNA transcripts are a cause of disease.

RNA EXISTS IN TWO MAJOR CLASSES

All eukaryotic cells have two major classes of RNA (**Table 36–1**), the **protein coding RNAs**, or **mRNAs**, and two forms of abundant **nonprotein coding RNAs** delineated on the basis of size: the large ribosomal RNAs (**rRNAs**) and long noncoding RNAs (**lncRNAs**) and small noncoding transfer RNAs (**tRNAs**), the small nuclear RNAs (**snRNAs**) and the micro and silencing RNAs (**miRNAs** and **siRNAs**). The mRNAs, rRNAs, and tRNAs are directly involved in protein synthesis while the other RNAs participate in either mRNA splicing (snRNAs) or modulation of gene expression by altering mRNA function (mi/siRNAs) and/or expression (lncRNAs). These RNAs differ in their diversity, stability, and abundance in cells.

TABLE 36–1 Classes of Eukaryotic RNA

RNA	Types	Abundance	Stability
<i>Protein Coding RNAs</i>			
Messenger (mRNA)	≥10 ⁵ Different species	2%-5% of total	Unstable to very stable
<i>Nonprotein Coding RNAs (ncRNAs)</i>			
Large ncRNAs			
Ribosomal (rRNA)	28S, 18S	80% of total	Very stable
lncRNAs	~1000s	~1%-2%	Unstable to very stable
Small ncRNAs			
Small ribosomal RNAs	5.8S, 5S	~2%	Very stable
Transfer RNAs	~60 Different species	~15% of total	Very stable
Small nuclear (snRNA)	~30 Different species	≤1% of total	Very stable
Micro/Silencing (mi/SiRNAs)	100s-1000	<1% of total	Stable

RNA IS SYNTHESIZED FROM A DNA TEMPLATE BY AN RNA POLYMERASE

The processes of DNA and RNA synthesis are similar in that they involve (1) the general steps of initiation, elongation, and termination with 5'–3' polarity; (2) large, multicomponent initiation and polymerization complexes; and (3) adherence to Watson-Crick base-pairing rules. However, DNA and RNA synthesis do differ in several important ways, including the following: (1) ribonucleotides are used in RNA synthesis rather than deoxyribonucleotides; (2) U replaces T as the complementary base for A in RNA; (3) a primer is not involved in RNA synthesis as RNA polymerases have the ability to initiate synthesis *de novo*; (4) in a given cell only portions of the genome are vigorously transcribed or copied into RNA, whereas the entire genome must be copied, once and only once during DNA replication; and (5) there is no highly active, efficient proofreading function during transcription.

The process of synthesizing RNA from a DNA template has been characterized best in prokaryotes. Although in mammalian cells, the regulation of RNA synthesis and the processing of the RNA transcripts are different from those in prokaryotes, the process of RNA synthesis *per se* is

quite similar in these two classes of organisms. Therefore, the description of RNA synthesis in prokaryotes, where it is best understood, is applicable to eukaryotes even though the enzymes involved and the regulatory signals, though related, are different.

The Template Strand of DNA Is Transcribed

The sequence of ribonucleotides in an RNA molecule is complementary to the sequence of deoxyribonucleotides in one strand of the double-stranded DNA molecule (see Figure 34–8). The strand that is transcribed or copied into an RNA molecule is referred to as the **template strand** of the DNA. The other DNA strand, the **nontemplate strand**, is frequently referred to as the **coding strand** of that gene. It is called this because, with the exception of T for U changes, it corresponds exactly to the sequence of the mRNA primary transcript, which encodes the (protein) product of the gene. In the case of a double-stranded DNA molecule containing many genes, the template strand for each gene will not necessarily be the same strand of the DNA double helix (Figure 36–1). Thus, a given strand of a double-stranded DNA molecule will serve as the template strand for some genes and the coding strand of other genes. Note that the nucleotide sequence of an RNA transcript will be the same (except for U replacing T) as that of the coding strand. The information in the template strand is read out in the 3'–5' direction. Though not shown in Figure 36–1, there are instances of genes embedded within other genes.

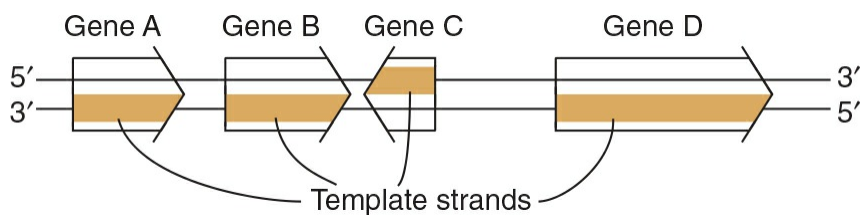

FIGURE 36–1 Genes can be transcribed off both strands of DNA. The arrowheads indicate the direction of transcription (polarity). Note that the template strand is always read in the 3'–5' direction. The opposite strand is called the coding strand because it is identical (except for T for U changes) to the mRNA transcript (the primary transcript in eukaryotic cells) that encodes the protein product of the gene.

DNA-Dependent RNA Polymerase Binds to a Distinct Site, the Promoter, and Initiates Transcription

DNA-dependent RNA polymerase (RNAP) is the enzyme responsible for the polymerization of ribonucleotides into a sequence complementary to the template strand of the gene (**Figures 36–2** and **36–3**). The enzyme attaches at a specific site—the promoter—on the DNA template. This is followed by initiation of RNA synthesis at the starting point, and the process continues until a termination sequence is reached (**Figure 36–3**). A **transcription unit** is defined as that region of DNA that includes the signals for transcription initiation, elongation, and termination. The RNA product, which is synthesized in the 5'–3' direction, is the **primary transcript**. Transcription frequency varies from gene to gene but can be quite high. An electron micrograph of transcription in action is presented in **Figure 36–4**. In prokaryotes, this can represent the product of several contiguous genes; in mammalian cells, it usually represents the product of a single gene. The 5' termini of the primary RNA transcript and the mature cytoplasmic RNA are identical. Thus, the **transcription start site (TSS)** corresponds to the 5' nucleotide of the mRNA. This is designated position +1, as is the corresponding nucleotide in the DNA. The numbers increase positively as the sequence proceeds *downstream* from the start site. This convention makes it easy to locate particular regions, such as intron and exon boundaries. The nucleotide in the promoter adjacent to the transcription initiation site in the upstream direction is designated –1, and these negative numbers increase as the sequence proceeds *upstream*, away from the TSS. This +/- numbering system provides a conventional way of defining the location of regulatory elements in a gene (**Figure 36–5**).

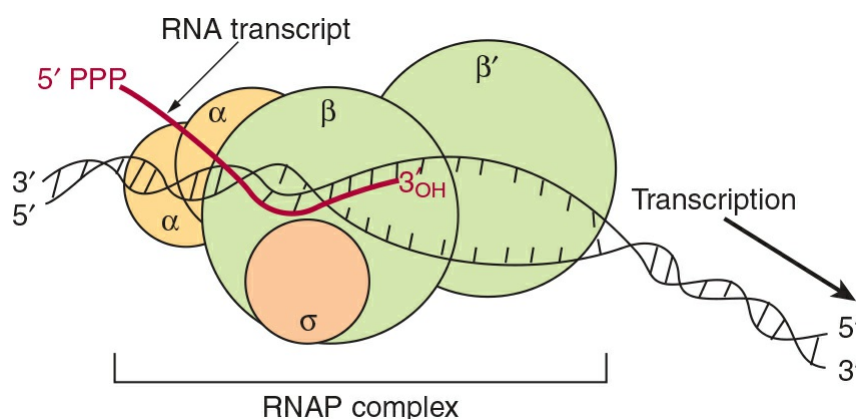

FIGURE 36–2 RNA polymerase catalyzes the polymerization of ribonucleotides into an RNA sequence that is complementary to the template strand of the gene. The RNA transcript has the same polarity (5'–3') as the coding strand but contains U rather than T. Bacterial RNAP consists of a core complex of two β subunits (β and β') and two α subunits.

The holoenzyme contains the σ subunit bound to the $\alpha_2 \beta\beta'$ core assembly. The ω subunit is not shown. The transcription “bubble” is an approximately 20-bp area of melted DNA, and the entire complex covers 30 to 75 bp of DNA depending on the conformation of RNAP.

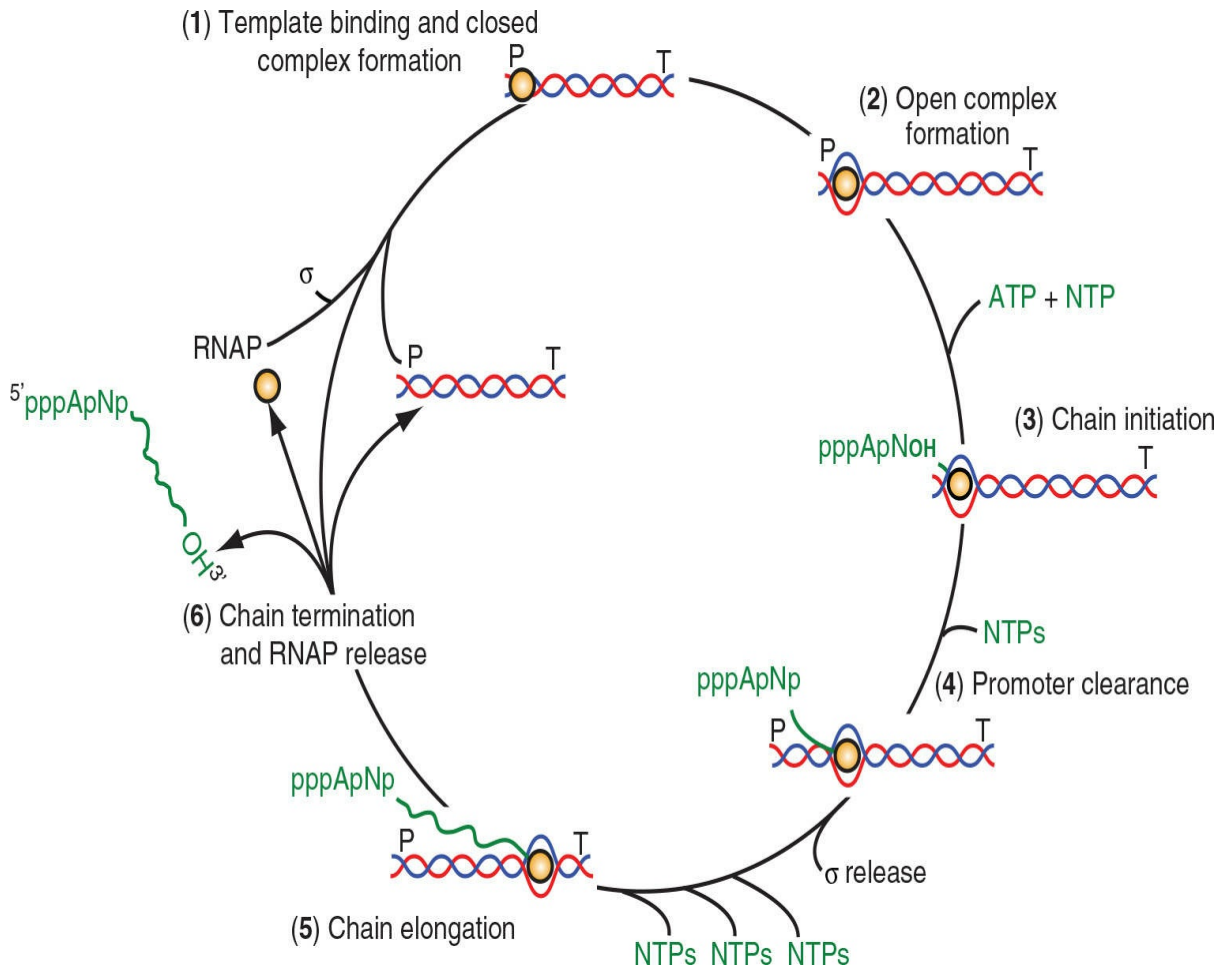

FIGURE 36–3 The transcription cycle. The transcription cycle can be described in six steps: **(1) Template binding and closed RNA polymerase-promoter complex formation:** RNAP binds to DNA and then locates a promoter (P) DNA sequence element, **(2) Open promoter complex formation:** Once bound to the promoter, RNAP melts the two DNA strands to form an open promoter complex; this complex is also referred to as the preinitiation complex or PIC. Strand separation allows the polymerase to access the coding information in the template strand of DNA **(3) Chain initiation:** Using the coding information of the template, RNAP catalyzes the coupling of the first base (often a purine) to the second, template-directed ribonucleoside triphosphate to form a dinucleotide (in this example forming the dinucleotide 5' pppApN_{OH} 3'). **(4) Promoter clearance:** After RNA chain length reaches ~10 to 20 nt,

the polymerase undergoes a conformational change and then is able to move away from the promoter, transcribing down the transcription unit. On many genes σ -factor is released from RNAP at this phase of the transcription cycle. **(5) Chain elongation:** Successive residues are added to the 3'-OH terminus of the nascent RNA molecule until a transcription termination DNA sequence element (**T**) is encountered. **(6) Chain termination and RNAP release:** Upon encountering the transcription termination site, RNAP undergoes an additional conformational change that leads to release of the completed RNA chain, the DNA template, and RNAP. RNAP can rebind to DNA beginning the promoter search process and the cycle is repeated. Note that all of the steps in the transcription cycle are facilitated by additional proteins, and indeed are often subjected to regulation by positive- and/or negative-acting factors.

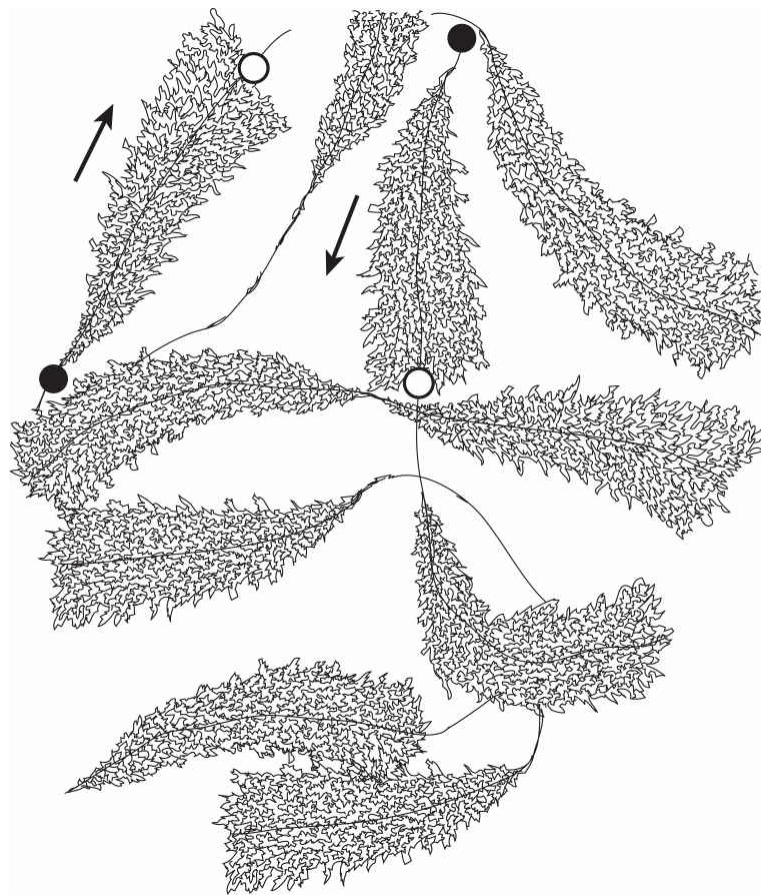

FIGURE 36–4 Schematic representation of an electron photomicrograph of multiple copies of amphibian rRNA-encoding genes in the process of being transcribed. The magnification is about 6000 \times . Note that the length of the transcripts increases as the RNA polymerase molecules progress along the individual rRNA genes from transcription start sites (filled circles) to transcription termination sites

(open circles). RNA polymerase I (not visualized here) is at the base of the nascent rRNA transcripts. Thus, the proximal end of the transcribed gene has short transcripts attached to it, while much longer transcripts are attached to the distal end of the gene. The arrows indicate the direction (5' → 3') of transcription.

The primary transcripts generated by RNA polymerase II—one of the three distinct nuclear DNA-dependent RNA polymerases in eukaryotes—are promptly modified by the addition of 7-methylguanosine triphosphate caps (see [Figure 34–10](#)), which persist and eventually appear on the 5' end of mature cytoplasmic mRNA. These caps are necessary for the subsequent processing of the primary transcript to mRNA, for the translation of the mRNA, and for protection of the mRNA against nucleolytic attack by 5'-exonucleases.

Bacterial DNA-Dependent RNA Polymerase Is a Multisubunit Enzyme

The basic DNA-dependent RNA polymerase of the bacterium *Escherichia coli* exists as an approximately 400-kDa core complex consisting of two identical α subunits, two large β and β' subunits, and an ω subunit. The β subunit binds Mg^{2+} ions and composes the catalytic subunit ([Figure 36–2](#)). The **core RNA polymerase, $\beta\beta'\alpha_2\omega$** , often termed **E**, associates with a specific protein factor (the **sigma [σ] factor**) to form **holoenzyme, $\beta\beta'\alpha_2\sigma$** , or **$E\sigma$** . The genes encoding all these proteins are essential for viability with an exception of w -encoding gene. The σ subunit enables the core enzyme to recognize and bind the promoter region ([Figure 36–5](#)) to form the **preinitiation complex (PIC)**. There are multiple, distinct σ -factor encoding genes in all bacterial species. Sigma factors have a dual role in the process of promoter recognition; σ association with core RNA polymerase decreases its affinity for nonpromoter DNA, while simultaneously increasing holoenzyme affinity for promoter DNA. The multiple σ -factors compete for interaction with limiting core RNA polymerase (ie, **E**). Each of these unique σ -factors act as a regulatory protein that modifies the promoter recognition specificity of the resulting unique RNA polymerase holoenzyme (ie, $E\sigma_1, E\sigma_2, \dots$). The appearance of different σ -factors and their association with core RNA polymerase to form novel holoenzyme forms $E\sigma_1, E\sigma_2, \dots$, can be correlated temporally with various programs of gene expression in prokaryotic systems such as

sporulation, growth in various poor nutrient sources, and the response to heat shock.

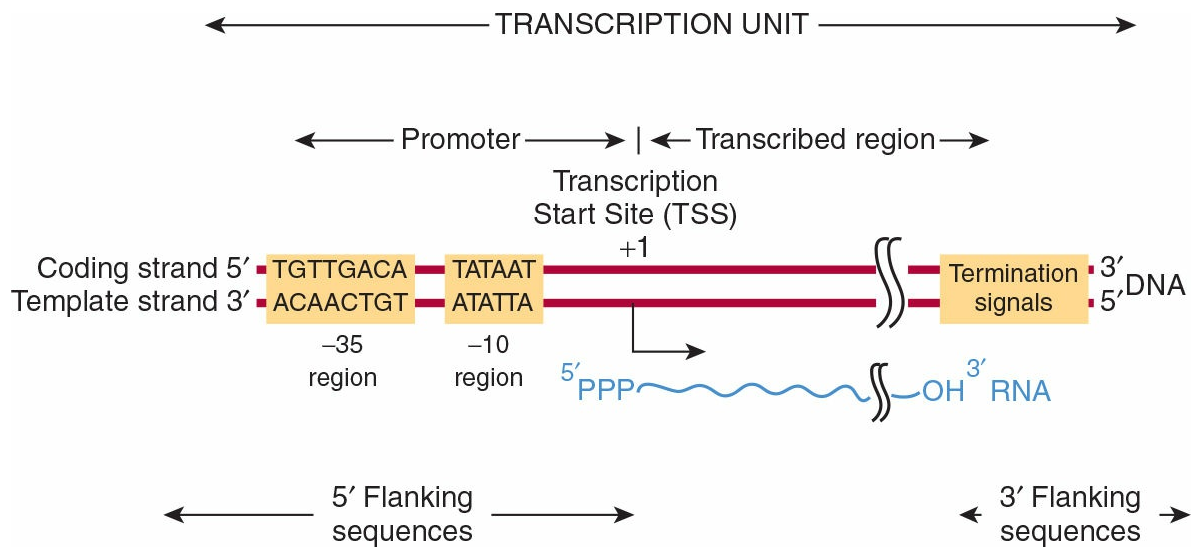

FIGURE 36–5 Prokaryotic promoters share two regions of highly conserved nucleotide sequence. These regions are located 35- and 10-bp upstream of the TSS, which is indicated as +1. By convention, all nucleotides upstream of the transcription initiation site (at +1) are numbered in a negative sense and are referred to as 5'-flanking sequences, while sequences downstream of the +1 TSS are numbered in a positive sense. Also by convention, the promoter DNA regulatory sequence elements such as the -35 and the -10 TATA elements are described in the 5' → 3' direction and as being on the coding strand. These elements function only in double-stranded DNA. Other transcriptional regulatory elements, however, can often act in a direction independent fashion, and such *cis*-elements are drawn accordingly in any schematic (Figure 36–8). Note that the transcript produced from this transcription unit has the same polarity or “sense” (ie, 5' → 3' orientation) as the coding strand. Termination *cis*-elements reside at the end of the transcription unit (see Figure 36–6 for more detail). By convention, the sequences downstream of the site at which transcription termination occurs are termed 3'-flanking sequences.

Mammalian Cells Possess Three Distinct Nuclear DNA-Dependent RNA Polymerases

Some of the distinguishing properties of mammalian nuclear RNA polymerases are described in Table 36–2. Each of these DNA-dependent RNA polymerases is responsible for transcription of different sets of

genes. The sizes of the RNA polymerases range from MW 500 to 600 kDa. These enzymes exhibit more complex subunit profiles than prokaryotic RNA polymerases. They all have two large subunits, which remarkably bear strong sequence and structural similarities to prokaryotic β and β' subunits, and a number of smaller subunits—as many as 14 in the case of RNA pol III. The functions of each of the subunits are not yet fully understood. A peptide toxin from the mushroom *Amanita phalloides*, α -amanitin, is a specific differential inhibitor of the eukaryotic nuclear DNA-dependent RNA polymerases and as such has proved to be a powerful research tool (Table 36–2). α -Amanitin blocks the translocation of RNA polymerase during phosphodiester bond formation.

TABLE 36–2 Nomenclature and Properties of Mammalian Nuclear DNA-Dependent RNA Polymerases

Form of RNA Polymerase	Sensitivity to α -Amanitin	Major Products
I	Insensitive	rRNA
II	High sensitivity	mRNA, lncRNA, miRNA, snRNA
III	Intermediate sensitivity	tRNA, 5s rRNA, some snRNAs

RNA SYNTHESIS IS A CYCLICAL PROCESS THAT INVOLVES RNA CHAIN INITIATION, ELONGATION, & TERMINATION

The process of RNA synthesis in bacteria—depicted in Figure 36–3—is cyclical and involves multiple steps. First RNA polymerase holoenzyme ($E\sigma$) must locate and then specifically bind a promoter (**P**; Figure 36–3). Once the promoter is located, the $E\sigma$ –promoter DNA complex undergoes a temperature-dependent conformational change and unwinds, or melts the DNA in and around the transcription start site (at +1). This complex is termed the PIC. Unwinding allows the active site of the $E\sigma$ to access the template strand, which of course dictates the sequence of ribonucleotides to be polymerized into RNA. The first nucleotide (typically, though not always a purine) then associates with the nucleotide-binding site of the enzyme, and in the presence of the next appropriate nucleotide bound to the polymerase, RNAP catalyzes the formation of the first phosphodiester

bond, and the nascent chain is now attached to the polymerization site on the β subunit of RNAP. This reaction is termed **initiation**. The analogy to the A and P sites on the ribosome should be noted; see [Figure 37–9](#). The nascent dinucleotide retains the 5'-triphosphate of the initiating nucleotide ([Figure 36–3](#), ATP).

RNA polymerase continues to incorporate nucleotides +3 to \sim +10, at which point the polymerase undergoes another conformational change and moves away from the promoter; this reaction is termed **promoter clearance**. On many genes the σ -factor dissociates from the $\beta\beta'\alpha_2$ assembly at this point. The **elongation phase** then commences, and here the nascent RNA molecule grows 5'–3' as consecutive NTP incorporation steps continue cyclically, antiparallel to the template. The enzyme polymerizes the ribonucleotides in the specific sequence dictated by the template strand and interpreted by Watson-Crick base-pairing rules. **Pyrophosphate (PP_i)** is released following each cycle of polymerization. As for DNA synthesis, this PP_i is rapidly degraded to two molecules of **inorganic phosphate (P_i)** by ubiquitous **pyrophosphatases**, thereby providing irreversibility on the overall synthetic reaction. The decision to stay at the promoter in a poised or stalled state, or transition to elongation can be an important regulatory step in both prokaryotic and eukaryotic mRNA gene transcription.

As the **elongation** complex containing RNA polymerase progresses along the DNA molecule, **DNA unwinding** must occur in order to provide access for the appropriate base pairing to the nucleotides of the coding strand. The extent of this transcription bubble (ie, DNA unwinding) is constant throughout transcription and has been estimated to be about 20 bp per polymerase molecule ([Figure 36–2](#)). Thus, the size of the unwound DNA region is dictated by the polymerase and is independent of the DNA sequence in the complex. RNA polymerase has an intrinsic “unwindase” activity that opens the DNA helix (ie, see PIC formation above). The fact that the DNA double helix must unwind, and the strands part at least transiently for transcription implies some temporary disruption of the nucleosome structure of eukaryotic cells. Topoisomerase both precedes and follows the progressing RNA polymerase to prevent the formation of superhelical tension that would serve to increase the energy required to unwind the template DNA ahead of RNAP.

Termination of the synthesis of RNA in bacteria is signaled by sequences in the template DNA ([Figure 36–3](#); **T**) and sequences within the transcript. On many genes RNAP alone efficiently terminates

transcription. However, on a subset of genes a **termination protein** termed **rho (ρ) factor** is required to mediate transcription termination. After termination both free core RNAP (E) and product RNA dissociate from the DNA template. The resulting free core RNAP (E) is able to associate with σ -factor to reform E_{σ} , and re-enter the transcription cycle. In eukaryotic cells, termination is less well understood; however, the proteins catalyzing RNA processing, termination, and polyadenylation all appear to load onto RNA polymerase II soon after initiation. More than one RNA polymerase molecule may transcribe the same template strand of a gene simultaneously, but the process is phased and spaced in such a way that at any one moment each is transcribing a different portion of the DNA sequence (Figures 36–1 and 36–4).

THE FIDELITY & FREQUENCY OF TRANSCRIPTION IS CONTROLLED BY PROTEINS BOUND TO CERTAIN DNA SEQUENCES

Analysis of the DNA sequence of specific genes has allowed the recognition of a number of sequences important in gene transcription. From the large number of bacterial genes studied, it is possible to construct consensus models of transcription initiation and termination signals.

The question, “How does RNAP find the correct site to initiate transcription?” is not trivial when the complexity of the genome is considered. *E. coli* has about 4×10^3 transcription initiation sites (ie, gene promoters) within the 4.2×10^6 bp genome. The situation is even more complex in humans, where as many as 150,000 distinct transcription initiation sites are distributed throughout 3×10^9 bp of DNA. Bacterial RNAP can bind, with low affinity, to many regions of DNA, but it scans the DNA sequence—at a rate of $\geq 10^3$ bp/s—until it recognizes certain specific regions of DNA to which it binds with higher affinity. These regions are termed promoters, and it is the base-specific association of RNAP with promoters that ensures accurate initiation of transcription. The promoter recognition-utilization process is the target for regulation in both bacteria and humans.

Bacterial Promoters Are Relatively Simple

Bacterial promoters are approximately 40 nucleotides (40 bp or four turns

of the DNA double helix) in length, a region small enough to be covered by an *E. coli* RNA holo polymerase molecule. In a consensus promoter, there are two short conserved sequence elements. Approximately 35-bp upstream of the transcription start site there is a consensus sequence of eight nucleotide pairs (consensus: 5'-TGTTGACA-3') to which the RNAP binds to form the so-called **closed complex**. More proximal to the transcription start site—about 10 nucleotides upstream—is a six-nucleotide-pair A+T-rich sequence (consensus: 5'-TATAAT-3'). These conserved sequence elements together comprise the promoter, and are shown schematically in [Figure 36–5](#). The latter sequence has a lower melting temperature because of its lack of GC nucleotide pairs. Thus, the so-called “**TATA box**” is thought to ease the dissociation of the two DNA strands so that RNA polymerase bound to the promoter region can have access to the nucleotide sequence of its immediately downstream template strand. Once the process of strand separation occurs, the combination of RNA polymerase plus promoter is called the **open complex**. Other bacteria have slightly different consensus sequences in their promoters, but all generally have two components to the promoter; these tend to be in the same position relative to the TSS, and in all cases the sequences between the two promoter elements have no similarity but still provide critical spacing functions that facilitate recognition of –35 and –10 sequences by the cognate RNA polymerase holoenzyme. Within a bacterial cell, different sets of genes are often coordinately regulated. One important way that this is accomplished is through the fact that these coregulated genes share particular –35 and –10 promoter sequences. These unique sets of promoters are recognized by different σ -factors bound to core RNA polymerase (ie, $E\sigma_1$, $E\sigma_2$,...).

Bacterial RNAP alone has the intrinsic ability to specifically terminate transcription on about 50% of cellular genes. On the remaining bacterial genes the accessory ρ termination factor is required. Proposed mechanisms for ρ -independent and ρ -dependent transcription termination events are presented in [Figure 36–6](#). The majority of eukaryotic mRNA gene transcription events are accessory transcription factor dependent.

A ρ -Independent Genes

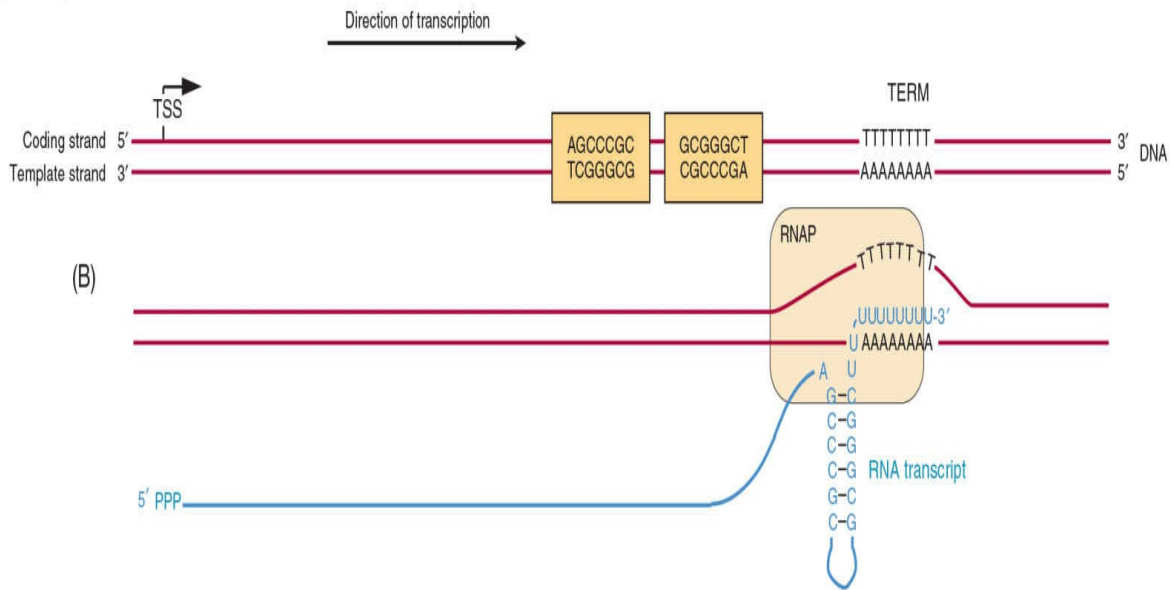

B ρ -Dependent Genes

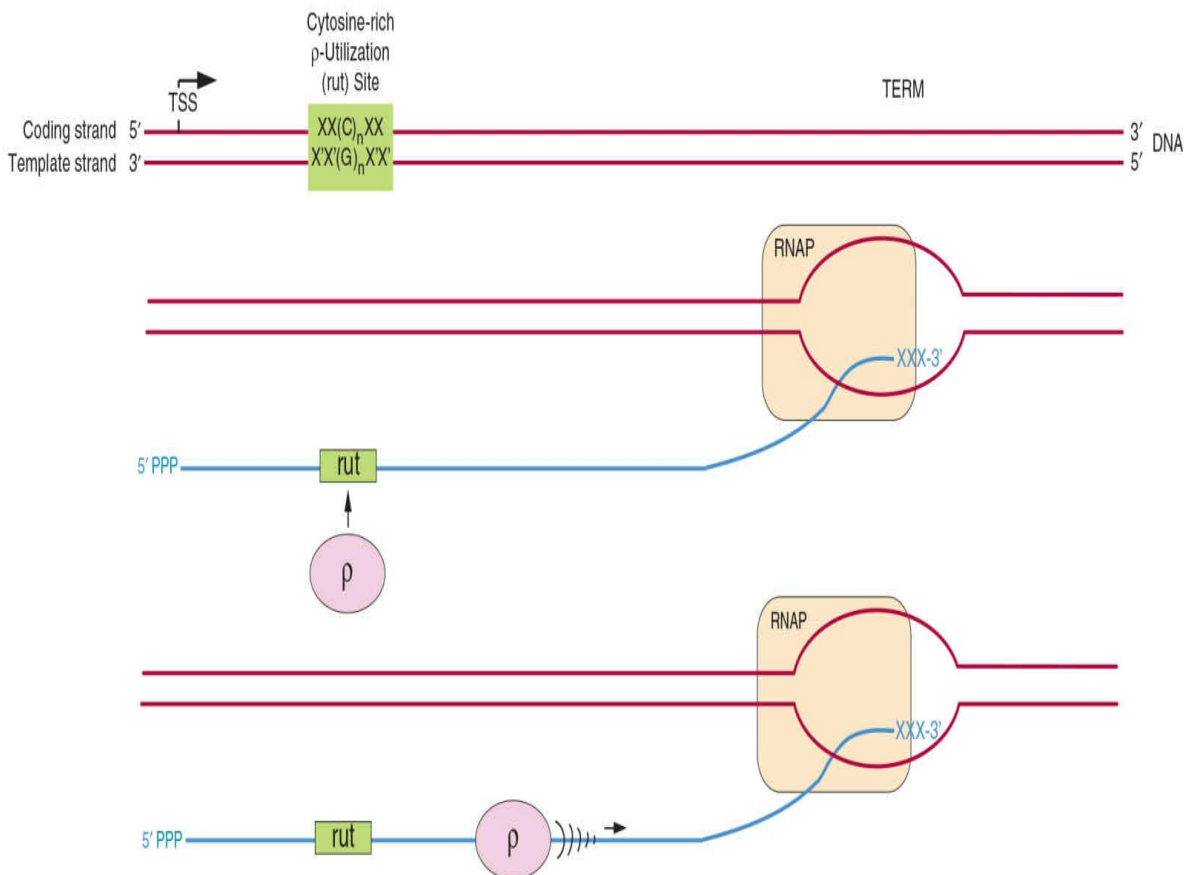

FIGURE 36–6 Two major mechanisms of transcription termination in bacteria. (A) Bacterial RNAP can directly terminate transcription following the recognition of both specific RNA and DNA signals within

transcripts/transcription units. In such situations, the transcription termination signal contains an inverted, hyphenated repeat (the two boxed areas) followed by a stretch of A bp in the template strand (here, bottom strand). The inverted repeat-containing sequences, when transcribed into RNA, can generate a secondary structure like that present in the RNA transcript shown. Formation of this RNA hairpin causes RNA polymerase to pause and upon recognition of the polyA sequence in the template strand induces transcription chain termination. **(B)** In cases where genes do not contain the two cis-elements noted above, a novel guanine-rich element in the DNA, and an accessory transcription factor, the ρ -protein, together serve to facilitate transcription termination. The transcript contains a run of C-residues that serve as a binding site for the ρ -factor, itself a hexameric ATPase. When present in the transcript, this element, termed a ρ -factor utilization site, or rut, is directly recognized by ρ -factor. Upon rut element binding, its intrinsic ATPase activity is activated and ρ -factor translocates 5' to 3' on the transcript until ρ encounters the transcribing RNA polymerase. ρ -factor-RNAP interaction induces transcription termination and DNA, RNA and protein dissociation.

As discussed in detail in [Chapter 38](#), bacterial gene transcription is controlled through the action of repressor and activator proteins. These proteins typically bind to unique and specific DNA sequences that lie adjacent to promoters. These repressors and activators affect the ability of the RNA polymerase to bind promoter DNA and/or form open complexes. The net effect is to stimulate or inhibit PIC formation and transcription initiation—consequently blocking or enhancing specific RNA synthesis.

Eukaryotic Promoters Are More Complex

There are two types of TSS proximal signals in DNA that control transcription in eukaryotic cells. One of these, the **promoter**, defines where transcription is to initiation transcription on the DNA template, while the other, DNA elements that stimulate and repress transcription contribute to the mechanisms that control how frequently transcription is to occur. For example, in the thymidine kinase (*tk*) gene of the herpes simplex virus (HSV), which utilizes transcription factors of its mammalian host for its early gene expression program, there is a single unique TSS, and accurate transcription initiation from this site depends on a nucleotide sequence located about 25 nucleotides upstream from the start site (ie, at –25) ([Figure 36–7](#)). This region has the sequence of **TATAAAAG** and

bears remarkable similarity to the functionally related **TATA box** that is located about 10-bp upstream from the prokaryotic mRNA TSS (Figure 36–5). Mutation of the TATA box markedly reduces transcription of the HSV *tk* gene, and many other cellular genes that contain this consensus **cis-active** element (Figures 36–7 and 36–8). The TATA box is usually located 25- to 30-bp upstream from the transcription start site in mammalian genes that contain it. The consensus sequence for a TATA box is TATAAA, though numerous variations have been characterized. The human TATA box is bound by the 34-kDa **TATA-binding protein (TBP)**, a subunit in at least two multisubunit complexes, TFIID and SAGA/P-CAF. The non-TBP subunits of TFIID are proteins called **TBP-associated factors (TAFs)**. Binding of the TBP-TAF TFIID complex to the TATA box sequence is thought to represent a first step in the formation of the transcription complex on the promoter.

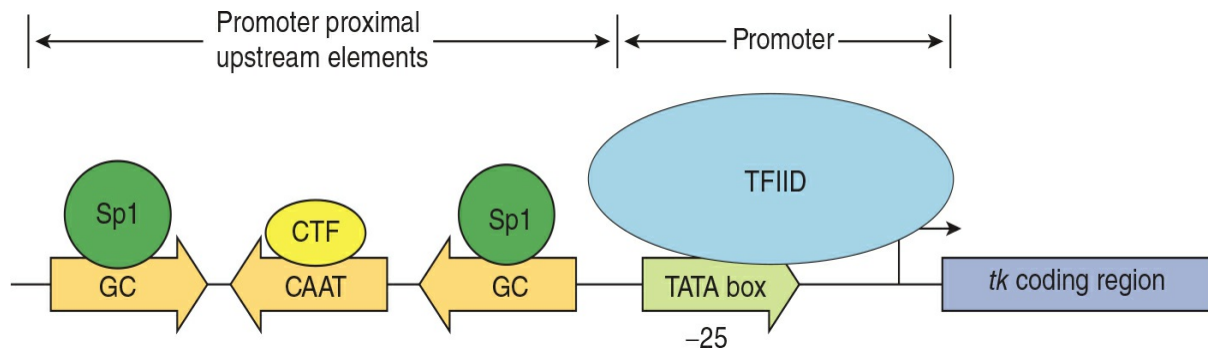

FIGURE 36–7 Transcription elements and binding factors in the herpes simplex virus thymidine kinase (*tk*) gene. DNA-dependent RNA polymerase II (not shown) binds to the region encompassing the TATA box (which is shown here bound by transcription factor TFIID) and TSS at +1 (see also Figure 36–9) to form a multicomponent PIC capable of initiating transcription at a single nucleotide (+1 TSS). The frequency of this event is increased by the presence of upstream *cis*-acting elements (the GC and CAAT boxes) located either near to the promoter (promoter proximal) or distant from the promoter (distal elements; see Figure 36–8). Proximal and distal DNA *cis*-elements are bound by *trans*-acting transcriptional activating factors, in this example Sp1 and CTF (also called C/EBP, NF1, NFY). These *cis*-elements can function independently of orientation (arrows).

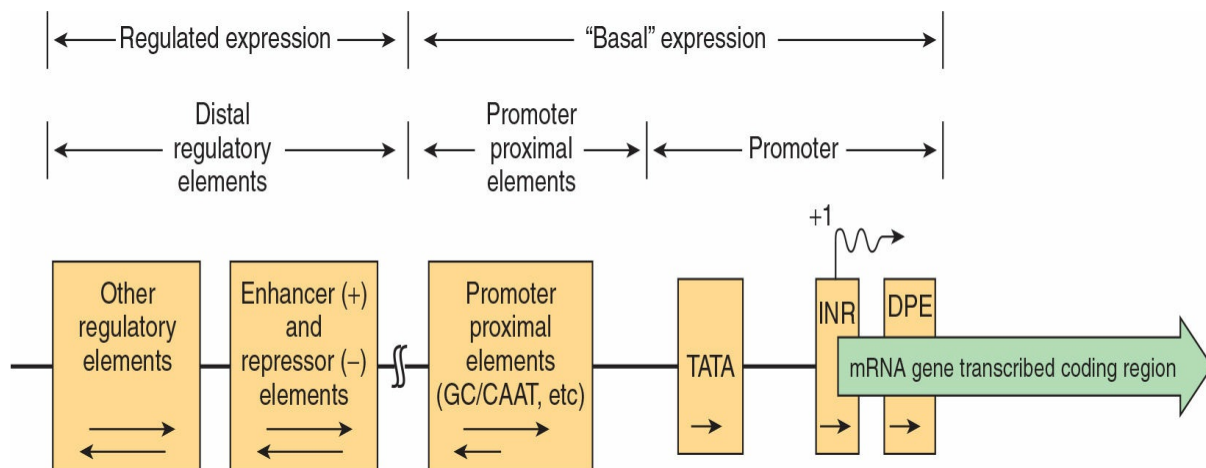

FIGURE 36–8 Schematic showing the transcription control regions in a hypothetical mRNA-producing eukaryotic gene transcribed by RNA polymerase II. Such a gene can be divided into its coding and regulatory regions, as defined by the transcription start site (arrow; +1). The coding region contains the DNA sequence that is transcribed into mRNA, which is ultimately translated into protein, typically after extensive mRNA processing via splicing (Figures 36–12 to 36–16). The regulatory region consists of two classes of elements. One is responsible for ensuring basal expression. The “promoter,” often composed of the TATA box and/or Inr and/or DPE elements (see Table 36–3), directs the RNA polymerase II transcription machinery to the correct site (fidelity). However, in certain genes that lack a consensus TATA, the so-called TATA-less promoters, an initiator (Inr) and/or DPE elements may direct the polymerase to this site. Another component, the upstream elements, specifies the frequency of initiation; such elements can either be proximal (50–200 bp) or distal (1000–10⁵ bp) to the promoter as shown. Among the best studied of the proximal elements is the CAAT box, but several other elements (bound by the transactivator proteins Sp1, NF1, AP1, etc; Table 36–3) may be used in various genes. The distal elements enhance or repress expression, several of which mediate the response to various signals, including hormones, heat shock, heavy metals, and chemicals. Tissue-specific expression also involves specific sequences of this sort. The orientation dependence of all the elements is indicated by the arrows within the boxes. For example, the proximal promoter elements (TATA box, INR, DPE) must be in the 5′ → 3′ orientation, while the proximal upstream elements often work best in the 5′ → 3′ orientation, most can be reversed. The locations of some elements are not fixed with respect to the transcription start site. Indeed, some elements responsible for regulated expression can be located interspersed with the upstream elements or can be located downstream from the start

site, within, or even downstream of the regulated gene itself.

TABLE 36–3 Some of the Mammalian RNA Polymerase II Transcription Control Elements, Their Consensus Sequences, and the Factors That Bind to Them

Element	Consensus Sequence	Factor
TATA box	TATAAA	TBP/TFIID
Inr	T/CT/cANT/AT/CT/c	TFIID
DPE	A/gGA/TCGTG	TFIID
CAAT box	CCAATC	C/EBP*, NF-Y*
GC box	GGGCGG	Sp1*
E-box	CAACTGAC	Myo D
κB motif	GGGACTTCC	NF-κB
Ig octamer	ATGCAAAT	Oct1, 2, 4, 6*
AP1	TGAG/cTC/AA	Jun, Fos, ATF*
Serum response	GATGCCATA	SRF
Heat shock	(NGAAN) ₃	HSF

Note: All elements listed are written 5' to 3' and only the top strand of the duplex element is shown. A complete list would include hundreds of examples. The asterisks signify that there are several members of this family. Nucleotides separated by a / indicate that either of two nucleotides can be at that position (ie, T/C in the Inr first position implies that either T or C can occupy that position; N implies any of the four DNA bases A, G, C, or T can occupy that particular position in the indicated *cis*-element).

A large number of eukaryotic mRNA-encoding genes lack a consensus TATA box. In such instances, additional DNA *cis*-elements, an **initiator sequence (Inr)** and/or the **downstream promoter element (DPE)**, direct the RNA polymerase II transcription machinery to the promoter and serve to direct RNA pol II to start transcription from the correct site. The Inr element spans the start site (from –3 to +5) and consists of the general consensus sequence TCA⁺¹ G/T T T/C (A⁺¹ indicates the first nucleotide transcribed, ie, TSS). The proteins that bind to Inr in order to direct pol II binding include TFIID. Promoters that have both a TATA box and an Inr may be “stronger,” or more frequently transcribed, than those that have

just one of these elements. The DPE has the consensus sequence A/GGA/TCGTG and is localized about 25-bp downstream of the +1 TSS. Like the Inr, DPE sequences are also bound by the TAF subunits of TFIID. In a survey of hundreds of thousands of eukaryotic protein coding genes, roughly 30% contained a TATA box and Inr, 25% contained Inr and DPE, 15% contained all three elements, whereas ~30% contained just the Inr.

Sequences generally, though not always, just upstream from the start site contribute importantly to how frequently transcription occurs. Not surprisingly, mutations in these regions reduce the frequency of transcription initiation 10-fold to 20-fold. Typical of these DNA elements are the GC and CAAT boxes, so named because of the DNA sequences involved. As illustrated in [Figure 36–7](#), each of these DNA elements are bound by a specific protein, Sp1 in the case of the GC box and CTF by the CAAT box; both bind through their distinct **DNA-binding domains (DBDs)**. The frequency of transcription initiation is a consequence of these protein-DNA interactions and complex interactions between particular domains of the transcription factors (distinct from the DBD domains—so-called **activation domains; ADs**) and the rest of the transcription machinery (RNA polymerase II, the **basal, or general factors, GTFs, TFIIA, B, D, E, F, H** and other coregulatory factors such as mediator, chromatin remodelers, and chromatin modifying factors). (See [Figures 36–9](#) and [36–10](#).) The protein-DNA interactions at the TATA box involving RNA polymerase II and other components of the basal transcription machinery ensures the fidelity of initiation.

Together, the promoter plus promoter-proximal *cis*-active upstream elements confer fidelity and modulate the frequency of initiation upon a gene respectively. The TATA box has a particularly rigid requirement for both position and orientation. As with bacterial promoters, single-base changes in any of these *cis*-elements can have dramatic effects on function by reducing the binding affinity of the cognate *trans*-factors (either TFIID/TBP or Sp1, CTF, and similar factors). The spacing of the TATA box, Inr, and DPE is also critical.

A third class of sequence elements also increase or decrease the rate of transcription of eukaryotic genes. These elements are called either **enhancers** or **repressors (or silencers)**, depending on how they effect transcription. They have been found in a variety of locations, both upstream and downstream of the transcription start site, and even within the transcribed protein coding portions of some genes. Enhancers and silencers can exert their effects when located thousands or even many tens of thousands of bases away from transcription units located on the same

chromosome. Surprisingly, enhancers and silencers can function in an orientation-independent fashion. Literally, hundreds of these elements have been described. In some cases, the sequence requirements for binding are rigidly constrained; in others, considerable sequence variation is allowed. Some sequences bind only a single protein; however, the majority of these regulatory sequences are bound by several different proteins. Together, these many transactors binding to promoter distal and proximal *cis*-elements, regulate transcription in response to a vast array of biologic signals. Such transcriptional regulatory events contribute importantly to control of gene expression.

Specific Signals Regulate Transcription Termination

The signals for the termination of transcription by eukaryotic RNA polymerase II are only poorly understood. It appears that the termination signals exist far downstream of the protein coding sequence of eukaryotic genes. For example, the transcription termination signal for mouse β -globin occurs at several positions 1000 to 2000 bases beyond the site at which the mRNA poly(A) tail will eventually be added. Less is known about the termination process or whether specific termination factors similar to the bacterial ρ -factor might be involved. However, it is known that formation of the mRNA 3' terminus, which is generated posttranscriptionally, is somehow coupled to events or structures formed at the time and site of initiation. Moreover, mRNA formation, and in this case mRNA 3'-end formation depends on a special structure present on the C-terminus of the largest subunit of RNA polymerase II, the **carboxy-terminal domain**, or **CTD**, and this process appears to involve at least two steps as follows. After RNA polymerase II has traversed the region of the transcription unit encoding the 3' end of the transcript, RNA endonucleases cleave the primary transcript at a position about 15 bases 3' of the consensus sequence **AAUAAA** that serves in eukaryotic transcripts as a **cleavage and polyadenylation signal**. Finally, this newly formed 3' terminal is polyadenylated in the nucleoplasm, as described below.

THE EUKARYOTIC TRANSCRIPTION COMPLEX

A complex apparatus consisting of as many as 50 unique proteins provides accurate and regulatable transcription of eukaryotic genes. The RNA polymerase enzymes (pol I, pol II, and pol III) transcribe information

contained in the template strand of DNA into RNA. These polymerases must recognize a specific site in the promoter in order to initiate transcription at the proper nucleotide. In contrast to the situation in prokaryotes though, eukaryotic RNA polymerases alone are not able to discriminate between promoter sequences and other, nonpromoter regions of DNA in the test tube. All eukaryotic RNA polymerases require other proteins known as general transcription factors or GTFs in order to catalyze specific transcription. RNA polymerase II requires TFIIA, B, D (or TBP), E, F, and H to both facilitate promoter-specific binding of the enzyme and formation of the PIC. RNA polymerases I and III require their own polymerase-specific GTFs. Within the cell the transcription machinery (RNA polymerase II and GTFs) and activator, proteins interact with another set of proteins—the **coactivators** (also known as **coregulators**). Coregulators bridge between enhancer DNA-bound activator proteins and the transcription machinery, and in so doing regulate the rate of transcription.

Formation of the Pol II Transcription Complex

In bacteria, a σ -factor–polymerase holoenzyme complex, $E\sigma$, selectively and directly binds to promoter DNA to form the PIC. The situation is much more complex in eukaryotic genes. mRNA-encoding genes, which are transcribed by pol II, are described as an example. In the case of pol II–transcribed genes, the function of σ -factors is assumed by a number of proteins. PIC formation requires pol II and the six GTFs (TFIIA, TFIIB, TFIID, TFIIE, TFIIF, TFIIH). These GTFs serve to promote RNA polymerase II transcription on essentially all genes. Some of these GTFs are composed of multiple subunits. The 15-subunit TFIID complex (TFIID consists of 15 subunits, TBP, and 13–14 TBP TAFs), which binds to the TATA box promoter element through its TBP and TAF subunits. TFIID is the only GTF that is independently capable of specific, high-affinity binding to promoter DNA.

TBP binds to the TATA box in the minor groove of DNA (most transcription factors bind in the major groove) and causes an approximately 100° bend or kink of the DNA helix. This bending is thought to facilitate the interaction of TAFs with other components of the transcription initiation complex, the multicomponent eukaryotic promoter, and possibly with factors bound to upstream elements. Although initially defined as a component solely required for transcription of pol II gene promoters, TBP, by virtue of its association with distinct, polymerase-

specific sets of TAFs, is also an important component of pol I and pol III transcription initiation complexes even if they do not contain TATA boxes.

The binding of TFIID marks a specific promoter for transcription. Of several subsequent *in vitro* steps, the first is the binding of TFIIA, then TFIIB to the TFIID-promoter complex. This results in a stable multiprotein-DNA complex, which is more precisely located and more tightly bound at the transcription initiation site. This complex attracts and tethers the pol II and TFIIF complex to the promoter. Addition of TFIIIE and TFIIH are the final steps in the assembly of the PIC. Each of these binding events extends the size of the complex so that finally about 60 bp (from -30 to $+30$ relative to the $+1$ TSS) are covered (Figure 36–9). The PIC is now complete and capable of basal transcription initiated from the correct nucleotide. In genes that lack a TATA box, the same factors are required. In such cases, the Inr and/or DPE serve to position the complex for accurate initiation of transcription (see Figure 36–8).

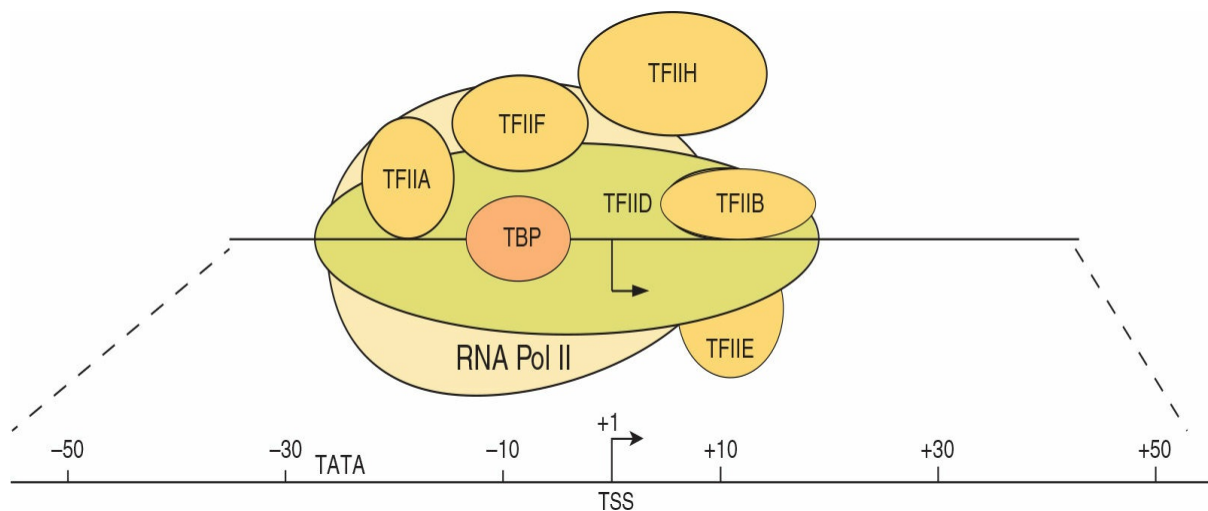

FIGURE 36–9 The eukaryotic basal transcription complex. Formation of the basal transcription complex begins when TFIID binds, via its TATA binding protein (TBP) subunit and several of its 14 TBP-associated factor (TAF) subunits, to the TATA box. TFIID then directs the assembly of several other components by protein-DNA and protein-protein interactions: TFIIA, B, E, F, H, and polymerase II (pol II). The entire complex spans DNA from about positions -30 to $+30$ relative to the TSS at $+1$ (marked by bent arrow). The atomic level, X-ray-derived structures of RNA polymerase II alone and of the TBP subunit of TFIID bound to TATA promoter DNA in the presence of either TFIIB or TFIIA have all been solved at 3-\AA resolution. The structures of mammalian and yeast

PICs have also recently been determined at 10-Å resolution by electron microscopy. Thus, the molecular structures of the transcription machinery in action are beginning to be elucidated. Much of this structural information is consistent with the models presented here.

Promoter Accessibility and Hence PIC Formation Is Often Modulated by Nucleosomes

On certain eukaryotic genes, the transcription machinery (pol II, etc) cannot access promoter sequences (ie, TATA–INR–DPE) because these essential promoter elements are wrapped up in nucleosomes (see [Figures 35–2, 35–3, and 36–10](#)). Only after transcription factors bind to enhancer DNA upstream of the promoter and recruit chromatin remodeling and modifying coregulatory factors, such as the Swi/Snf, SRC-1, p300/CBP (see [Chapter 42](#)), P/CAF or other factors, are the repressing nucleosomes removed ([Figure 36–10](#)). Once the promoter is “open” following nucleosome eviction, GTFs and RNA polymerase II can bind and initiate mRNA gene transcription. Note that the binding of transactivators and coregulators can be sensitive to, and/or directly control the composition and/or covalent modification status of the DNA and the histones within the nucleosomes in and around the promoter and enhancer, and thereby increase or decrease the ability of all the other components required for PIC formation to interact with a particular gene. This so-called **epigenetic code of DNA, histone and protein modifications** can contribute importantly to gene transcription control. Indeed, mutations in proteins that catalyze (code writers), remove (code erasers), or differentially bind (code readers) modified DNA and/or histones can lead to human disease.

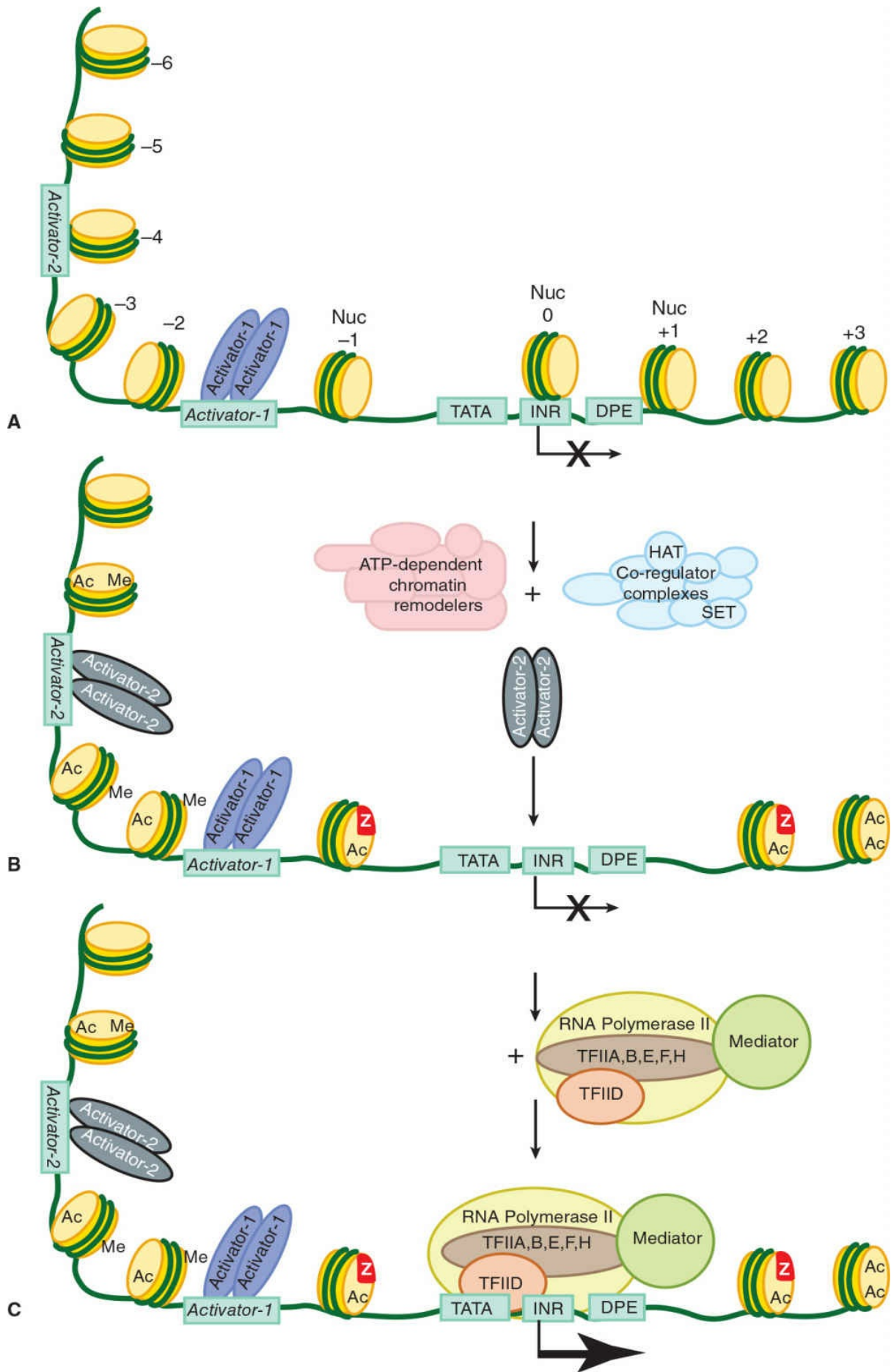

FIGURE 36–10 Nucleosome covalent modifications, remodeling, and eviction by chromatin-active coregulators modulate PIC formation and transcription. Shown in (A), is an inactive mRNA encoding gene (see X over TSS) with a single dimeric transcription factor (Activator-1; violet ovals) bound to its cognate enhancer binding site (*Activator-1*). This particular enhancer element was nucleosome-free and hence available for interaction with its cognate activator binding protein. However, this gene is still inactive (X over TSS) due to the fact that a portion of its enhancer (in this illustration the enhancer is bipartite and composed of *Activator-1* and *Activator-2*, DNA-binding sites) and the promoter are covered by nucleosomes. Recall that nucleosomes have ~150 bp of DNA wound around the histone octamer. Hence, the single nucleosome over the promoter will occlude access of the transcription machinery (pol II + GTFs) to the TATA, Inr and/or DPE promoter elements. (B) Enhancer DNA-bound Activator-1 interacts with any of a number of distinct ATP-dependent chromatin remodelers and chromatin-modifying coregulator complexes. These coregulators together have the ability to both move, or remodel (ie, change the octameric histone content, and/or remove nucleosomes) through the action of various ATP-dependent remodelers as well as to covalently modify nucleosomal histones using intrinsic acetylases (HAT; resulting in acetylation [Ac]) and methylases (SET; resulting in methylation [Me], among other PTMs; [Table 35–1](#)) carried by subunits of these complexes. (C) The resulting changes in nucleosome position and nucleosome occupancy (ie, nucleosomes -4, 0 and +1), composition (nucleosome -1 and nucleosome +2; replacement of nucleosomal H2A with histone H2AX[Z]) thus allows for the binding of the second Activator-2 dimer to *Activator-2* DNA sequences, which ultimately leads to the binding of the transcription machinery (TFIIA, B, D, E, F, H; polymerase II and mediator) to the promoter (TATA-INR-DPE) and the formation of an active PIC, which leads to activated transcription (large arrow at TSS).

Phosphorylation Activates Pol II

Eukaryotic pol II consists of 12 subunits. As noted above, the two largest subunits of pol II (MW 220 and 150 kDa) are homologous to the bacterial β' and β subunits. In addition to the increased number of subunits, eukaryotic pol II differs from its prokaryotic counterpart in that it has a series of heptad repeats with consensus sequence Tyr-Ser-Pro-Thr-Ser-

Pro-Ser at the carboxyl terminus of the largest pol II subunit, the so-called **CTD** or **C-terminal Domain**. This CTD has 26 repeated units in yeast and 52 units in mammals. The CTD is a substrate for several enzymes (kinases, phosphatases, prolyl isomerases, glycosylases); phosphorylation of the CTD was the first CTD PTM discovered. Among other proteins the kinase subunit of TFIIF can modify the CTD. Covalently modified CTD is the binding site, or platform, for a wide array of proteins, and it has been shown to interact with many mRNA modifying and processing enzymes and nuclear transport proteins. The association of these factors with the CTD of RNA polymerase II (and other components of the basal machinery) thus serves to couple transcription initiation with mRNA capping, splicing, 3'-end formation, and transport to the cytoplasm. Pol II polymerization is activated when phosphorylated on the Ser and Thr residues and displays reduced activity when the CTD is dephosphorylated. CTD phosphorylation/dephosphorylation is critical for promoter clearance, elongation, termination, and even appropriate mRNA processing. Pol II lacking the CTD tail is incapable of activating transcription, in vitro and cells expressing pol II lacking the CTD are inviable. These results underscore the importance of this domain to mRNA biogenesis.

Pol II can associate with other proteins termed **mediator** or **Med** proteins to form a complex sometimes referred to as the pol II holoenzyme; this complex can form on the promoter or in solution prior to PIC formation. The Med proteins (over 30 proteins; Med1-Med31) are essential for appropriate regulation of pol II transcription by serving myriad roles, both activating and repressing transcription. Thus, mediator, like TFIID is a transcriptional coregulator (**Figure 36-11**).

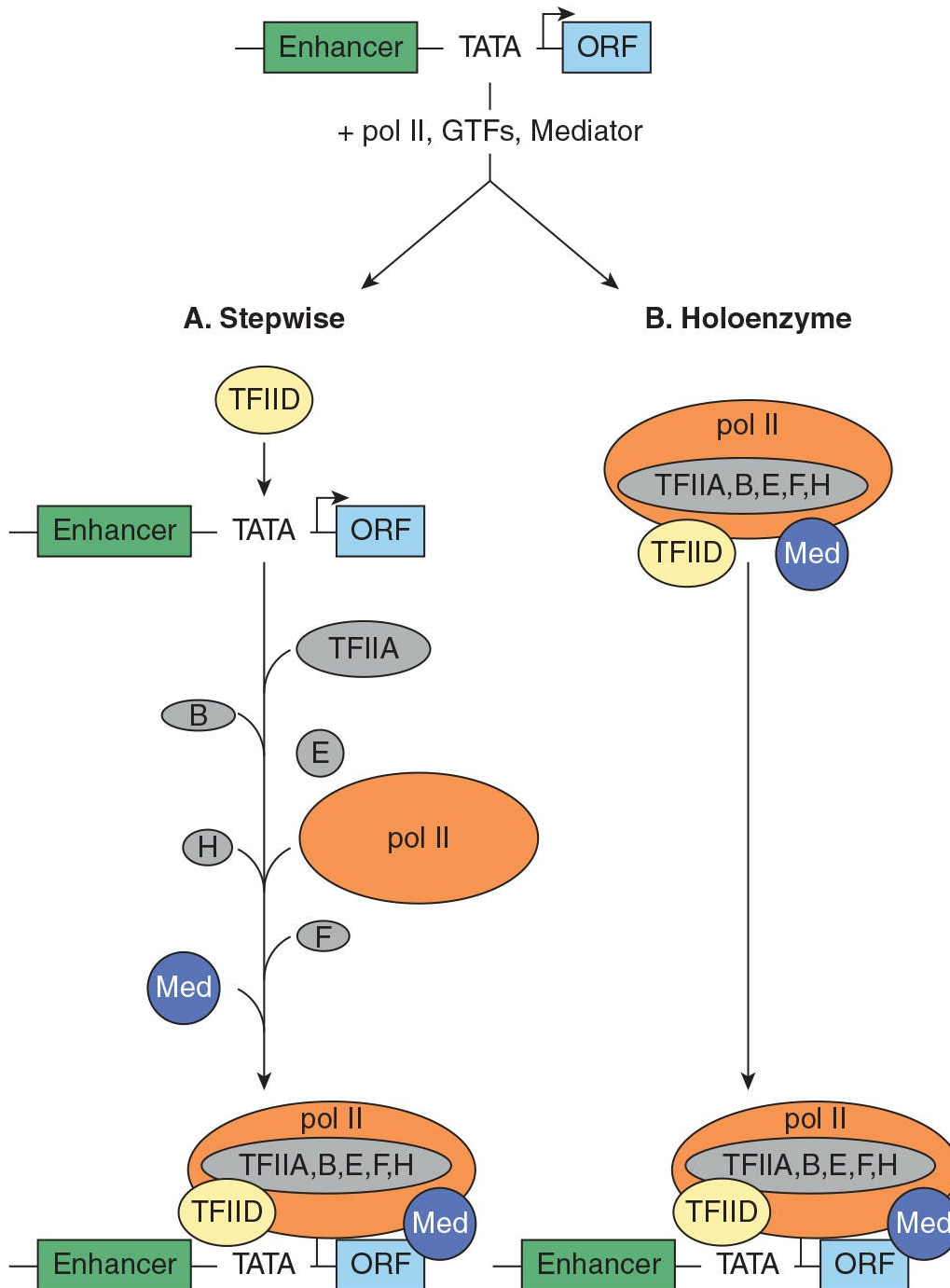

FIGURE 36–11 Models for the formation of an RNA polymerase II preinitiation complex. Shown at top is a typical mRNA gene transcription unit: enhancer-promoter (TATA)-TSS (bent arrow) and ORF (open reading frame; sequences encoding the protein) within the transcribed region. PICs have been shown to form by at least two distinct mechanisms *in vitro*: **(A)** the stepwise binding of GTFs, pol II, and mediator (Med), or **(B)** by the binding of a single multiprotein complex composed of pol II, Med, and the six GTFs. DNA-binding transactivator proteins specifically bind enhancers and in part facilitate PIC formation (or PIC function) by

binding directly to the TFIID-TAF subunits, or Med subunits of mediator (not shown, see [Figure 36–10](#)), or other components of the transcription machinery. The molecular mechanism(s) by which such protein–protein interactions stimulate transcription remain a subject of intense investigation.

The Role of Transcription Activators & Coregulators

TFIID was originally considered to be a single protein, TBP. However, several pieces of evidence led to the discovery that TFIID is actually a complex consisting of TBP and the 14 TAFs. The first evidence that TFIID was more complex than just the TBP molecules came from the observation that TBP binds to a 10-bp segment of DNA, immediately over the TATA box of the gene, whereas native holo-TFIID covers a 35-bp or larger region ([Figure 36–9](#)). Second, purified recombinant *E. coli*-expressed TBP has a molecular mass of 20 to 40 kDa (depending on the species), whereas the native TFIID complex has a mass of about 1000 kDa. Finally, and perhaps most importantly, TBP supports basal transcription but not the augmented transcription provided by certain activators, for example, Sp1 bound to the GC box. TFIID, on the other hand, supports both basal and enhanced transcription by Sp1, Oct1, AP1, CTF, ATF, etc. ([Table 36–3](#)). The TAFs are essential for this activator-enhanced transcription. There are likely several forms of TFIID in metazoans that differ slightly in their complement of TAFs. Thus, different combinations of TAFs with TBP—or one of several recently discovered TBP-like factors (TLFs)—bind to different promoters, and recent reports suggest that this may account for the tissue- or cell-selective gene activation noted in various promoters and for the different strengths of certain promoters. TAFs, since they are required for the action of activators, are often called coactivators or coregulators. There are thus three classes of transcription factors involved in the regulation of pol II genes: pol II and GTFs, coregulators, and DNA-binding activator or repressor proteins ([Table 36–4](#)). How these classes of proteins interact to govern both the site and frequency of transcription is a question of central importance and active investigation. It is currently thought that coregulators both act as a bridge between the DNA-binding transactivators and pol II/GTFs, and act to modify chromatin.

TABLE 36–4 Three Classes of Transcription Factors Involved in mRNA Gene Transcription

General Mechanisms	Specific Components
Basal components	RNA polymerase II, TBP, TFIIA, B, D, E, F, and H
Coregulators	TAFs (TBP + TAFs) = TFIID; certain genes Mediator, Meds Chromatin modifiers (pCAF, p300/CBP) Chromatin remodelers (Swi/Snf)
Activators	SP1, ATF, CTF, AP1, etc

Two Models Can Explain the Assembly of the Preinitiation Complex

The formation of the PIC described above is based on the sequential addition of purified components as observed through *in vitro* experiments. An essential feature of this model is that PIC assembly takes place on a DNA template where the transcription proteins all have ready access to DNA. Accordingly, transcription activators, which have autonomous DNA binding and activation domains (DBDs and ADs; see [Chapter 38](#)), are thought to function by stimulating PIC formation. Here the TAF or mediator complexes are viewed as bridging factors that communicate between the upstream-bound activators, and the GTFs and pol II. This view assumes that there is **stepwise assembly** of the PIC—promoted by various interactions between activators, coactivators, and PIC components, and is illustrated in panel A of [Figure 36–11](#). This model is supported by observations that many of these proteins can indeed bind to one another *in vitro*.

Recent evidence suggests that there is another possible mechanism of PIC formation and thus transcription regulation. First, large preassembled complexes of GTFs and pol II are found in cell extracts, and these complexes can associate with the promoter in a single step. Second, the rate of transcription achieved when activators are added to limiting concentrations of pol II holoenzyme can be matched by artificially increasing the concentration of pol II and GTFs in the absence of activators. Thus, at least *in vitro*, one can establish conditions where activators are not in themselves absolutely essential for PIC formation. These observations led to the “**recruitment**” **hypothesis**, which has now

been tested experimentally. Simply stated, the role of activators and some coactivators may be solely to recruit a preformed holoenzyme–GTF complex to the promoter. The requirement for an activation domain is circumvented when either a component of TFIID or the pol II holoenzyme is artificially tethered, using recombinant DNA techniques, to the DBD of an activator. This anchoring, through the DBD component of the activator molecule, leads to a transcriptionally competent structure, and there is no further requirement for the activation domain of the activator. In this view, the role of activation domains is to direct preformed holoenzyme–GTF complexes to the promoter; they do not assist in PIC assembly (see panel B, [Figure 36–11](#)). In this model, the efficiency of the recruitment process directly determines the rate of transcription at a given promoter.

RNA MOLECULES ARE PROCESSED BEFORE THEY BECOME FUNCTIONAL

In prokaryotic organisms, the primary transcripts of mRNA-encoding genes begin to serve as translation templates even before their transcription has been completed. This can occur because the site of transcription is not compartmentalized into the nucleus as it is in eukaryotic organisms. Thus, transcription and translation are coupled in prokaryotic cells.

Consequently, prokaryotic mRNAs are subjected to little processing prior to carrying out their intended function in protein synthesis. Indeed, appropriate regulation of some genes (eg, the *Trp* operon) relies on this coupling of transcription and translation. Prokaryotic rRNA and tRNA molecules are transcribed in units considerably longer than the ultimate molecule. In fact, many of the tRNA transcription units encode more than one tRNA molecule. Thus, in prokaryotes, the processing of these rRNA and tRNA precursor molecules is required for the generation of the mature functional molecules.

Nearly all eukaryotic RNA primary transcripts undergo extensive processing between the time they are synthesized and the time at which they serve their ultimate function, whether it be as mRNA, miRNAs, or as a component of the translation machinery such as rRNA or tRNA. Processing occurs primarily within the nucleus. The processes of transcription, RNA processing, and even RNA transport from the nucleus are highly coordinated. Indeed, a transcriptional coactivator termed SAGA in yeasts and P/CAF in human cells is thought to link transcription activation to RNA processing by recruiting a second complex termed transcription export (TREX) to transcription elongation, splicing, and

nuclear export. **TREX** represents a likely molecular link between transcription elongation complexes, the RNA splicing machinery, and nuclear export (**Figure 36–12**). This coupling presumably dramatically increases both the fidelity and rate of processing and movement of mRNA to the cytoplasm for translation.

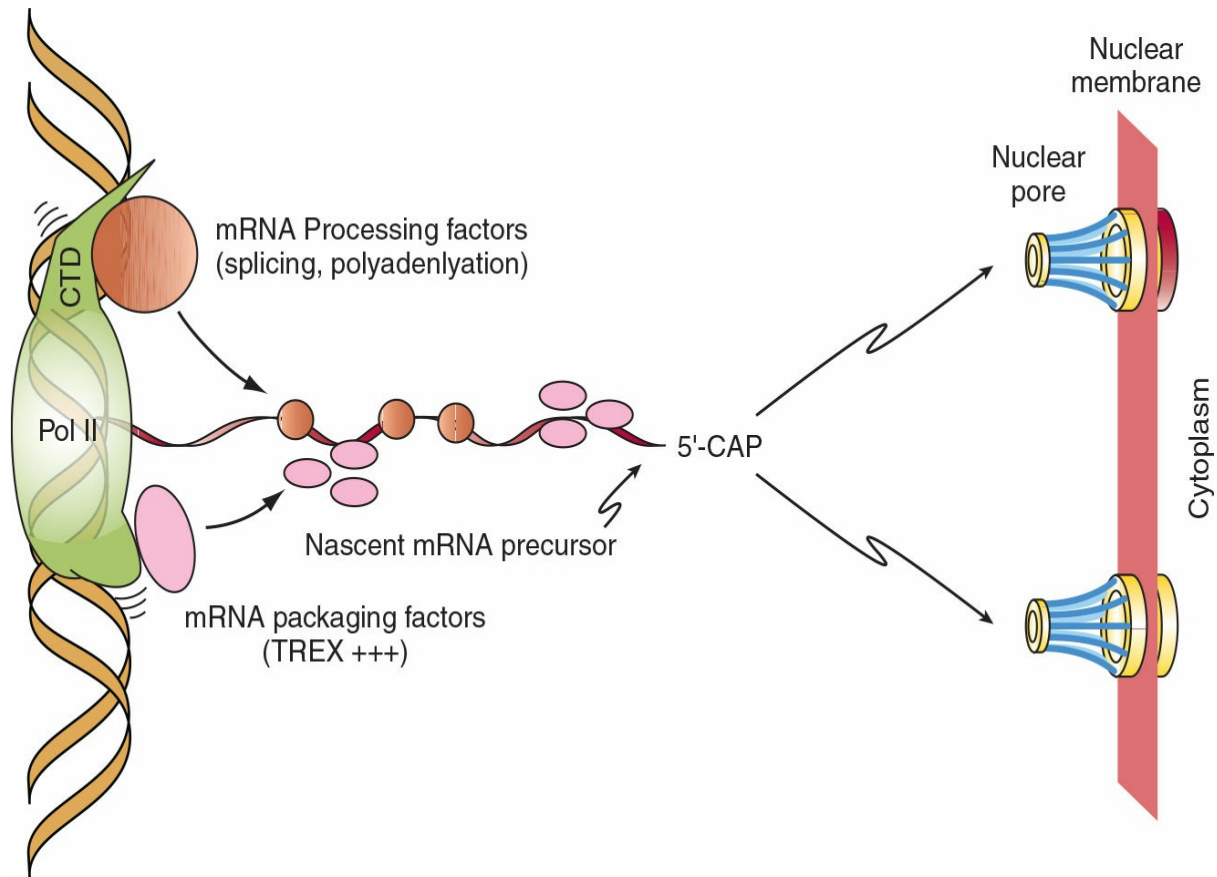

FIGURE 36–12 RNA polymerase II–mediated mRNA gene transcription is cotranscriptionally coupled to RNA processing and transport. Shown is RNA pol II actively transcribing an mRNA encoding gene (elongation top to bottom of figure). RNA processing factors (ie, SR/RRM-motif-containing splicing factors as well as polyadenylation and termination factors) interact with the C-terminal domain (CTD, composed of multiple copies of a heptapeptide with consensus sequence –YSPTSPS–) of pol II, while mRNA packaging and transport factors such as THO/TREX complex (pink ovals) are recruited to the nascent mRNA primary transcript either through direct pol II interactions as shown or through interactions with SR/splicing factors (brown circles) resident on the nascent mRNA. Note that the CTD is not drawn to scale. The evolutionarily conserved CTD of the Rpb1 subunit of pol II is in reality 5 to 10 times the length of the polymerase due to its many prolines and

consequent unstructured nature, and thus a significant docking site for RNA processing and transport proteins. In both cases, nascent mRNA chains are thought to be more rapidly and accurately processed due to the immediate recruitment of these many factors to the growing mRNA (precursor) chain. Following appropriate mRNA processing, the mature mRNA is delivered to the nuclear pores (Figures 36–17, 49–4) dotting the nuclear membrane, where, upon transport through the pores, the mRNAs can be engaged by ribosomes and translated into protein.

The Coding Portions (Exons) of Most Eukaryotic mRNA Encoding Genes Are Interrupted by Introns

The RNA sequences that appear in mature RNAs are termed **exons**. In mRNA encoding genes these exons are often interrupted by long sequences of DNA that neither appear in mature mRNA, nor contribute to the genetic information ultimately translated into the amino acid sequence of a protein molecule (see Chapter 35). In fact, these sequences often interrupt the coding region of protein-encoding genes. These **intervening sequences**, or **introns**, exist within most but not all mRNA encoding genes of higher eukaryotes. Human mRNA-encoding gene exons average ~150 nt, while introns are much more heterogeneous, ranging from 10 to 30,000 nucleotides in length. The intron RNA sequences are cleaved out of the transcript, and the exons of the transcript are appropriately spliced together in the nucleus before the resulting mRNA molecule is transported to the cytoplasm for translation (Figures 36–13 and 36–14).

Introns Are Removed & Exons Are Spliced Together

Several different splicing reaction mechanisms for intron removal have been described. The one most frequently used in eukaryotic cells is described below. Although the sequences of nucleotides in the introns of the various eukaryotic transcripts—and even those within a single transcript—are quite heterogeneous, there are reasonably conserved sequences at each of the two exons–intron (splice) junctions and at the branch site, which is located 20 to 40 nucleotides upstream from the 3′–splice site (see consensus sequences in Figure 36–14). A special multicomponent complex, the **spliceosome**, is involved in converting the primary transcript into mRNA. Spliceosomes consist of the primary transcript, five snRNAs (U1, U2, U4, U5, and U6), and more than 60 proteins, many of which contain conserved **RRM (RNA recognition)** and

SR (serine–arginine) protein motifs. Collectively, the five snRNAs and RRM/SR-containing proteins form a small nuclear ribonucleoprotein termed an **snRNP complex**. It is likely that this penta-snRNP spliceosome forms prior to interaction with mRNA precursors. snRNPs are thought to position the exon and intron RNA segments for the necessary splicing reactions. The splicing reaction starts with a cut at the junction of the 5' exon (donor on left) and intron (**Figure 36–13**). This is accomplished by a nucleophilic attack by an adenylyl residue in the branch point sequence located just upstream from the 3' end of this intron. The free 5' terminus then forms a loop or lariat structure that is linked by an unusual 5'–2' phosphodiester bond to the reactive A in the PyNPyPyPuAPy branch site sequence (**Figure 36–14**). This adenylyl residue is typically located 20 to 30 nucleotides upstream from the 3' end of the intron being removed. The branch site identifies the 3'–splice site. A second cut is made at the junction of the intron with the 3' exon (donor on right). In this second transesterification reaction, the 3' hydroxyl of the upstream exon attacks the 5' phosphate at the downstream exon–intron boundary and the lariat structure containing the intron is released and hydrolyzed. The 5' and 3' exons are ligated to form a continuous sequence.

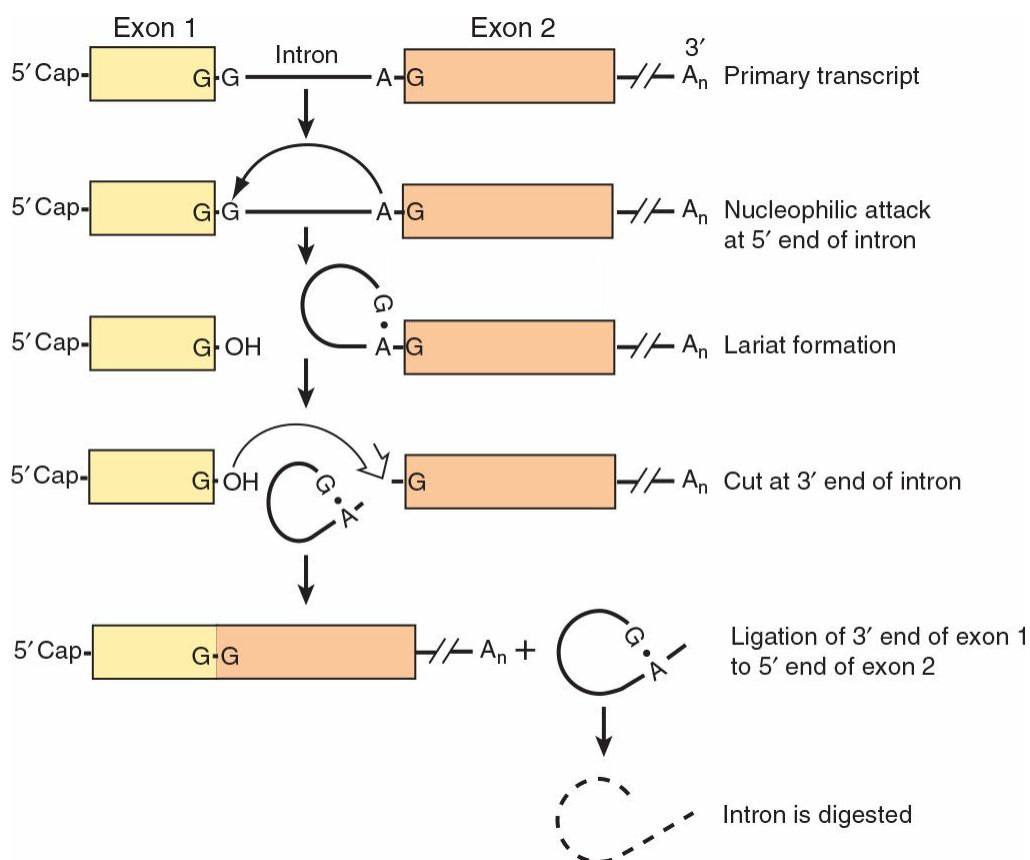

FIGURE 36–13 The processing of the primary transcript to mRNA.

In this hypothetical transcript, the 5' (**left**) end of the intron is cut (\rightarrow) and a structure resembling a lariat forms between the **G** at the 5' end of the intron and an **A** near the 3' end, in the consensus sequence UACUAAC. This sequence is called the branch site, and it is the 3' most **A** that forms the 5'–2' bond with the G. The 3' (**right**) end of the intron is then cut (\downarrow). This releases the lariat, which is digested, and exon 1 is joined to exon 2 at G residues.

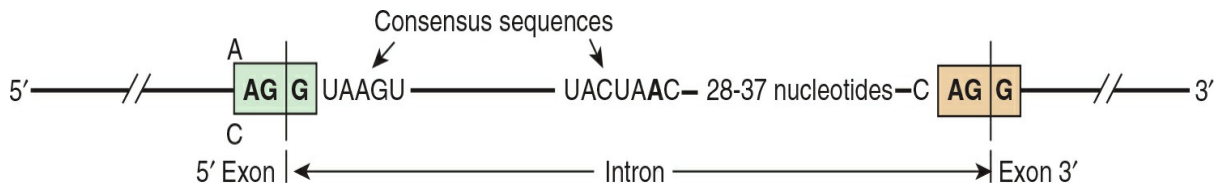

FIGURE 36–14 Consensus sequences at splice junctions. The 5' (donor; **left**) and 3' (acceptor; **right**) sequences are shown. Also shown is the yeast consensus sequence (UACUAAC) for the branch site. In mammalian cells, this consensus sequence is PyNPyPyPuAPy, where Py is a pyrimidine, Pu is a purine, and N is any nucleotide. The branch site is located 20 to 40 nucleotides upstream from the 3'–splice site.

The snRNAs and associated proteins are required for formation of the various structures and intermediates. U1 within the snRNP complex binds first by base pairing to the 5' exon–intron boundary. U2 within the snRNP complex then binds by base pairing to the branch site, and this exposes the nucleophilic A residue. U4/U5/U6 within the snRNP complex mediates an ATP-dependent protein-mediated unwinding that results in disruption of the base-paired U4–U6 complex with the release of U4. U6 is then able to interact first with U2, then with U1. These interactions serve to approximate the 5'–splice site, the branch point with its reactive A, and the 3'–splice site. This alignment is enhanced by U5. This process also results in the formation of the loop or lariat structure. The two ends are cleaved, probably by the U2–U6 within the snRNP complex. U6 is certainly essential, since yeast cells deficient in this snRNA are not viable. It is important to note that RNA serves as the catalytic agent. This sequence of events is then repeated in genes containing multiple introns. In such cases, a definite pattern is followed for each gene, though the introns are not necessarily removed in sequence—1, then 2, then 3, etc.

Alternative Splicing Provides for Production of Different mRNAs from a Single mRNA Primary

Transcript, Thereby Increasing the Genetic Potential of an Organism

The processing of mRNA molecules is a site for regulation of gene expression. Alternative patterns of mRNA splicing result from tissue-specific adaptive and developmental control mechanisms. Interestingly, recent studies suggest that alternative splicing is controlled, at least in part, through chromatin epigenetic marks (ie, [Table 35–1](#)). This form of coupling of transcription and mRNA processing may either be kinetic and/or mediated through interactions between specific histone PTMs and alternative splicing factors that can load onto nascent mRNA gene transcripts during the process of transcription ([Figure 36–12](#)).

As mentioned above, the sequence of exon–intron splicing events generally follows a hierarchical order for a given gene. The fact that very complex RNA structures are formed during splicing—and that a number of snRNAs and proteins are involved—affords numerous possibilities for a change of this order and for the generation of different mRNAs. Similarly, the use of alternative termination-cleavage polyadenylation sites also results in mRNA variability. Some schematic examples of these processes, all of which occur in nature, are shown in [Figure 36–15](#).

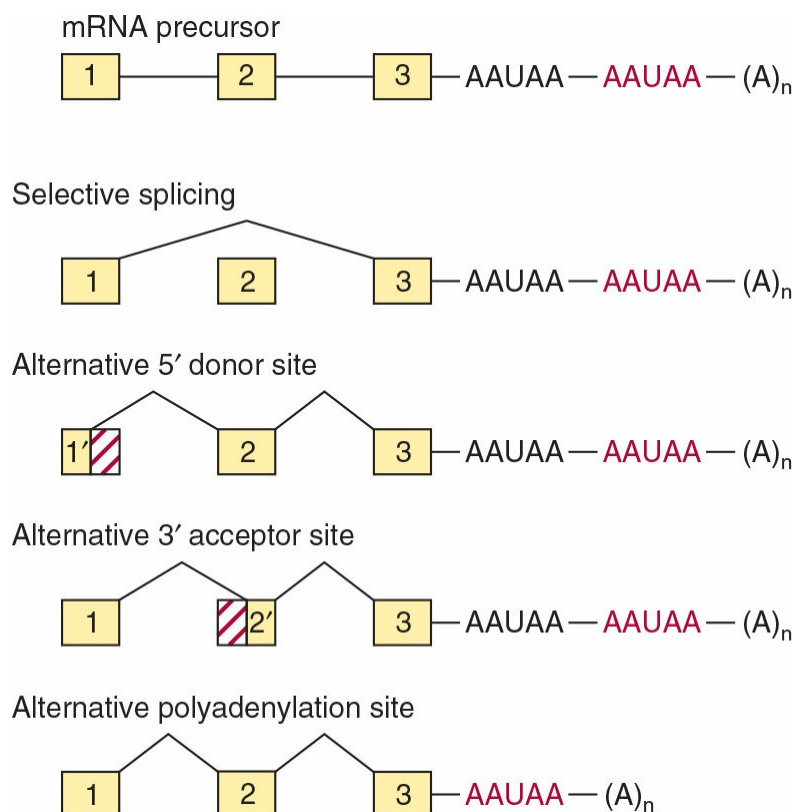

FIGURE 36–15 Mechanisms of alternative processing of mRNA

precursors. This form of mRNA processing involves the selective inclusion or exclusion of exons, the use of alternative 5'–donor or 3'–acceptor sites, and the use of different polyadenylation sites, and dramatically increases the differential protein coding potential of the genome.

Not surprisingly, defects in mRNA splicing can cause disease. One of the first examples of the critical importance of accurate splicing was the discovery that one form of β -thalassemia, a disease in which the β -globin gene of hemoglobin is severely underexpressed results from a nucleotide change at an exon–intron junction. This mutation precludes removal of the intron, altering the translational reading frame of β -globin mRNA, thereby blocking the β -chain protein production and hence hemoglobin.

Alternative Promoter Utilization Also Provides a Form of Regulation

Tissue-specific regulation of gene expression can be provided by alternative splicing, as noted above, by regulatory DNA control elements in the promoter or by the use of alternative promoters. The glucokinase (*GK*) gene consists of 10 exons interrupted by 9 introns. The sequence of exons 2 to 10 is identical in liver and pancreatic β cells, the primary tissues in which *GK* protein is expressed. Expression of the *GK* gene is regulated very differently—by two different promoters—in these two tissues. The liver promoter and exon 1L are located near exons 2 to 10; exon 1L is ligated directly to exon 2. By contrast, the pancreatic β -cell promoter is located about 30-kbp upstream. In this case, the 3' boundary of exon 1B is ligated to the 5' boundary of exon 2. The liver promoter and exon 1L are excluded and removed during the splicing reaction (**Figure 36–16**). The existence of multiple distinct promoters allows for cell- and tissue-specific expression patterns of a particular gene (mRNA). In the case of *GK*, insulin and cAMP (see **Chapter 42**) control *GK* transcription in liver, while glucose controls *GK* expression in β cells. Moreover, as noted above, such variation in spliced mRNAs can also change the protein coding potential of these mRNAs.

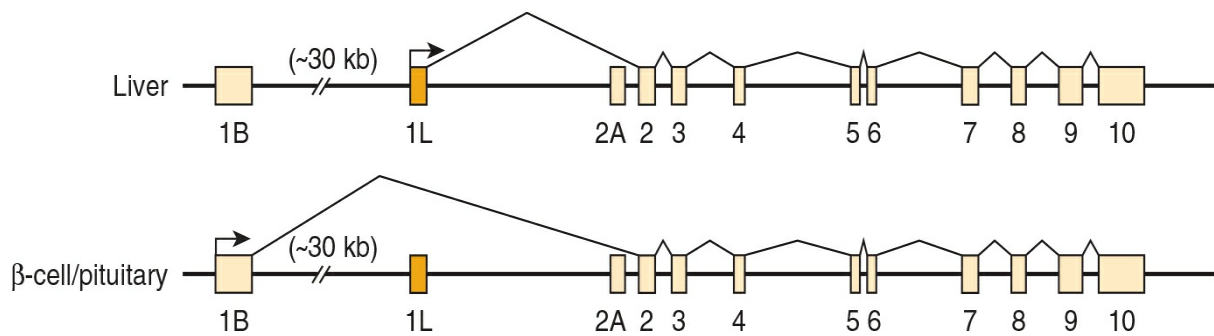

FIGURE 36–16 Alternative promoter use in the liver and pancreatic β -cell glucokinase (GK) genes. Differential regulation of the glucokinase gene is accomplished by the use of tissue-specific promoters. The β -cell GK gene promoter and exon 1B are located about 30-kbp upstream from the liver promoter and exon 1L. Each promoter has a unique structure and is regulated differently. Exons 2 to 10 are identical in the two genes, and the GK proteins encoded by the liver and β -cell mRNAs have identical kinetic properties.

Both Ribosomal RNAs & Most Transfer RNAs Are Processed From Larger Precursors

In mammalian cells, the three rRNA molecules (28S, 18S, 5.8S) are transcribed as part of a single large 45S precursor molecule. The precursor is subsequently processed in the nucleolus to provide these three RNA components for the ribosome subunits found in the cytoplasm. The rRNA genes are located in the nucleoli of mammalian cells. Hundreds of copies of these genes are present in every cell. This large number of genes is required to synthesize sufficient copies of each type of rRNA to form the 10^7 ribosomes required for round of cell duplication. Whereas a single mRNA molecule may be copied into 10^5 protein molecules, providing a large amplification, the rRNAs are end products. This lack of amplification requires both a large number of genes and a high transcription rate, typically synchronized with cell growth rate. Similarly, tRNAs are often synthesized as precursors, with extra sequences both 5' and 3' of the sequences comprising the mature tRNA. A small fraction of tRNAs contain introns.

RNAs CAN BE EXTENSIVELY MODIFIED

As introduced in the description of tRNAs (see [Figure 34–11](#)), essentially all RNAs are covalently modified after transcription. It is clear that at least

some of these modifications are regulatory.

Messenger RNA Is Modified at the 5' & 3' Ends

Eukaryotic mRNAs contain a **7-methylguanosine cap structure** at their 5' terminus (see [Figure 34–10](#)), and most have a **poly(A) tail** at the 3' terminus. The cap structure is added to the 5' end of the newly transcribed mRNA precursor in the nucleus very soon after synthesis and prior to transport of the mRNA molecule to the cytoplasm. The 5' cap of the RNA transcript is required both for efficient translation initiation (see [Figure 37–7](#)) and protection of the 5' end of mRNA from attack by 5' → 3' exonucleases. The secondary methylations of mRNA molecules, those on the 2'-hydroxy and the N⁷ of adenylyl residues, occur after the mRNA molecule has appeared in the cytoplasm.

Poly(A) tails are added to the 3' end of mRNA molecules in a posttranscriptional processing step. The mRNA is first cleaved about 20 nucleotides downstream from an AAUAA recognition sequence. Another enzyme, **poly(A) polymerase**, adds a poly(A) tail which is subsequently extended to as many as 200 A residues. The poly(A) tail both protects the 3' end of mRNA from 3' → 5' exonuclease attack and facilitates translation (see [Figure 37–7](#)). The presence or absence of the poly(A) tail does not determine whether a precursor molecule in the nucleus appears in the cytoplasm, because all poly(A)-tailed nuclear mRNA molecules do not contribute to cytoplasmic mRNA, nor do all cytoplasmic mRNA molecules contain poly(A) tails (histone mRNAs are most notable in this regard). Following nuclear transport, cytoplasmic enzymes in mammalian cells can both add and remove adenylyl residues from the poly(A) tails; this process has been associated with an alteration of mRNA stability and translatability.

The size of some cytoplasmic mRNA molecules, even after the poly(A) tail is removed, is still considerably greater than the size required to code for the specific protein for which it is a template, often by a factor of 2 or 3. The extra nucleotides occur in untranslated (nonprotein coding) exonic regions both 5' and 3' of the coding region; the longest untranslated sequences are usually at the 3' end. The **5' UTR and 3' UTR** sequences have been implicated in RNA processing, transport, storage, degradation, and translation; each of these reactions potentially contributes additional levels of control of gene expression. Some of these posttranscriptional events involving mRNAs occur in cytoplasmic organelles termed P bodies (see [Chapter 37](#)).

Micro-RNAs Are Derived From Large Primary Transcripts Through Specific Nucleolytic Processing

The majority of miRNAs are transcribed by RNA pol II into **primary transcripts** termed **pri-miRNAs**. pri-miRNAs are 5'-capped and 3'-polyadenylated (**Figure 36–17**). pri-miRNAs are synthesized from transcription units encoding one or several distinct miRNAs; these transcription units are either located independently in the genome or within the intronic DNA of other genes. Given this organization miRNA-encoding genes must therefore minimally possess a distinct promoter, coding region, and polyadenylation/termination signals. pri-miRNAs have extensive 2° structure, and this intramolecular structure is maintained following processing by the **Drosha-DGCR8 nuclease**; the portion containing the RNA hairpin is preserved, transported through the nuclear pore via the action of exportin 5, and once in the cytoplasm, further processed by the heterodimeric **dicer nuclease-TRBP complex** to a **21 or 22-mer**. Ultimately, one of the two strands is selected for loading into the **RNA-induced silencing complex (RISC)**, which is composed of one of four **Argonaute proteins (Ago 1 → 4)**, to form a mature, functional 21–22 nt single stranded miRNA. siRNAs are produced similarly. Once in the RISC complex, miRNAs can modulate mRNA function by one of three mechanisms: (a) promoting mRNA degradation directly; (b) stimulating CCR4/NOT complex-mediated poly(A) tail degradation; or (c) inhibition of translation by targeting the 5'-methyl cap binding translation factor eIF4 (see **Figures 37–7** and **37–8**) or the ribosome directly. Recent data suggest that at least some regulatory miRNA-encoding genes may be linked, and hence coevolve, with their target genes.

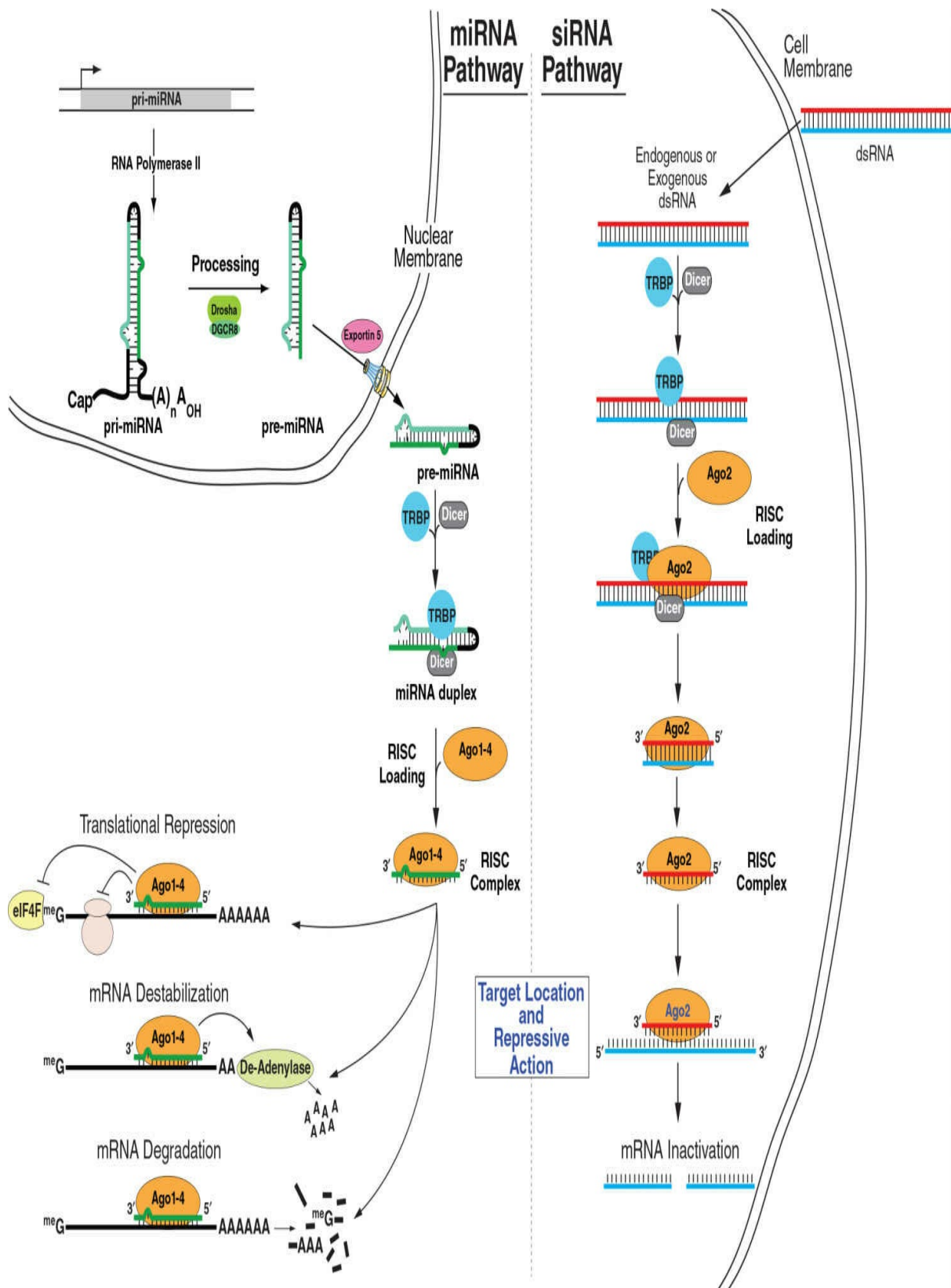

FIGURE 36–17 Biogenesis of micro (mi) and silencing (si)RNAs. (Left) miRNA encoding genes are transcribed by RNA pol II into a primary miRNA (pri-miRNA), which is 5'-capped and polyadenylated as is typical of mRNA coding primary transcripts. This pri-miRNA is

subjected to processing within the nucleus by the action of the Drosha-DGCR8 nuclease, which trims sequences from both 5' and 3' ends to generate the pre-miRNA. This partially processed double-stranded RNA is transported through the nuclear pore by exportin-5. The cytoplasmic pre-miRNA is then trimmed further by the action of the heterodimeric nuclease termed Dicer (TRBP-Dicer), to form the 21–22 nt miRNA duplex. One of the two resulting 21–22 nucleotide-long RNA strands is selected, the duplex unwound, and the selected strand loaded into the RNA-induced silencing complex, or RISC complex thereby generating the mature, functional miRNA. Following target mRNA location and sequence-specific miRNA–mRNA annealing, the functional miRNA can modulate mRNA function by one of three mechanisms: translational repression, mRNA destabilization by mRNA deadenylation, or mRNA degradation. **(Right)** The siRNA pathway generates functional siRNAs from large double-stranded RNAs that are formed either intracellularly by RNA–RNA hybridization (inter- or intramolecular) or from extracellular sources such as RNA viruses. These viral dsRNAs are again processed to ~22 nt siRNA dsRNA segments via the heterodimeric Dicer nuclease, loaded into the Ago2-containing RISC complex, one strand is then selected to generate the siRNA that locates target RNA sequences via sequence-specific siRNA–RNA annealing. This ternary target RNA–siRNA–Ago2 complex induces RNA cleavage, which inactivates the target RNA.

RNA Editing Alters mRNA Sequence After Transcription

The central dogma states that for a given gene and gene product there is a linear relationship between the coding sequence in DNA, the mRNA sequence, and the protein sequence (see [Figure 35–7](#)). Changes in the DNA sequence should be reflected in a change in the mRNA sequence and, depending on codon usage, in protein sequence. However, exceptions to this dogma have been documented. Coding information can be changed at the mRNA level by **RNA editing**. In such cases, the coding sequence of the mRNA differs from that in the cognate DNA. An example is the apolipoprotein B (*apoB*) gene and mRNA. In liver, the single *apoB* gene is transcribed into an mRNA that directs the synthesis of a 100-kDa protein, apoB100. In the intestine, the same gene directs the synthesis of the identical mRNA primary transcript; however, a cytidine deaminase converts a CAA codon in the mRNA to UAA at a single specific site.

Rather than encoding glutamine, this codon becomes a termination signal (see [Table 37–1](#)), and hence production of a truncated 48-kDa protein (apoB48) results. ApoB100 and apoB48 have different functions in the two organs. A growing number of other examples include a glutamine to arginine change in the glutamate receptor and several changes in trypanosome mitochondrial mRNAs, generally involving the addition or deletion of uridine. The exact extent of RNA editing genomewide is unknown, but current estimates suggest that perhaps 0.01% of mRNAs are edited in this fashion. Recently, editing of miRNAs has been described suggesting that these two forms of posttranscriptional control mechanisms could cooperatively contribute to gene regulation.

Transfer RNA Is Extensively Processed & Modified

As described in [Chapters 34 & 37](#), the tRNA molecules serve as adapter molecules for the translation of mRNA into protein sequences. The tRNAs contain many modifications of the standard bases A, U, G, and C, including methylation, reduction, deamination, and rearranged glycosidic bonds. Further posttranscriptional modification of the tRNA molecules includes nucleotide alkylations and the attachment of the characteristic CpCpA_{OH} terminal at the 3' end of the molecule by the enzyme nucleotidyl transferase. The 3' OH of the A ribose is the point of attachment for the specific amino acid that is to enter the polymerization reaction of protein synthesis. The methylation of mammalian tRNA precursors probably occurs in the nucleus, whereas the cleavage and attachment of CpCpA_{OH} are cytoplasmic functions, since the terminal nucleotides turn over more rapidly than do the tRNA molecules themselves. Specific aminoacyl tRNA synthetases within the cytoplasm of mammalian cells are required for the attachment of the different amino acids to the CpCpA_{OH} residues (see [Chapter 37](#)).

RNA CAN ACT AS A CATALYST

In addition to the catalytic action served by the snRNAs in the formation of mRNA, several other enzymatic functions have been attributed to RNA. **Ribozymes** are RNA molecules with catalytic activity. These generally involve transesterification reactions, and most are concerned with RNA metabolism (splicing and endoribonuclease). Recently, a rRNA component has been implicated in hydrolyzing an aminoacyl ester and thus to play a central role in peptide bond function (peptidyl transferases; see [Chapter](#)

37). Collectively, these observations, made using RNA molecules derived from the organelles from plants, yeast, viruses, and higher eukaryotic cells, show that RNA can act as an enzyme, and have revolutionized thinking about enzyme action and the origin of life itself.

SUMMARY

- RNA is synthesized from a DNA template by the enzyme DNA-dependent RNA polymerase.
- While bacteria contain but a single RNA polymerase ($\beta\beta\alpha_2\sigma\omega$), there are three distinct nuclear DNA-dependent RNA polymerases in mammals: RNA polymerases I, II, and III. These enzymes catalyze the transcription of rRNA (pol I), mRNA/mi/siRNAs/lncRNAs (pol II), and tRNA and 5S rRNA (pol III) encoding genes.
- RNA polymerases interact with unique *cis*-active regions of genes, termed promoters, in order to form PICs capable of initiation. In eukaryotes, the process of pol II PIC formation requires, in addition to polymerase, multiple general transcription factors (GTFs), TFIIA, B, D, E, F, and H.
- Eukaryotic PIC formation can occur on accessible promoters either stepwise—by the sequential, ordered interactions of GTFs and RNA polymerase with DNA promoters—or in one step by the recognition of the promoter by a preformed GTF-RNA polymerase holoenzyme complex.
- Transcription exhibits three phases: initiation, elongation, and termination. All are dependent on distinct DNA *cis*-elements and can be modulated by distinct *trans*-acting protein factors.
- The presence of nucleosomes can either enhance or occlude the binding of both transactors and the transcription machinery to their cognate DNA *cis*-elements, thereby with modulating transcription.
- Most eukaryotic RNAs are synthesized as precursors that contain excess sequences which are removed prior to the generation of mature, functional RNA. These processing reactions provide additional potential steps for regulation of gene expression.
- Eukaryotic mRNA synthesis results in a pre-mRNA precursor that contains extensive amounts of excess RNA (introns) that must be precisely removed by RNA splicing to generate functional, translatable mRNA composed of exonic coding and 5' and 3' noncoding sequences.

- All steps—from changes in DNA template, sequence, and accessibility in chromatin to RNA stability and translatability—are subject to modulation and hence are potential control sites for eukaryotic gene regulation.

REFERENCES

- Davis MC, Kesthely CA, Franklin EA, MacLellan SR: The essential activities of the bacterial sigma factor. *Can J Microbiol* 2017;63:89-99.
- Decker KB, Hinton DM: Transcription regulation at the core: similarities among bacterial, archaeal, and eukaryotic RNA polymerases. *Ann Rev Microbiol* 2013;67:113-139.
- Elkon R, Ugalde AP, Agami R: Alternative cleavage and polyadenylation: extent, regulation and function. *Nat Rev Gen* 2013;14:496-506.
- Kugel JF, Goodrich JA: Finding the start site: redefining the human initiator element. *Genes Dev* 2017;31:1-2.
- Lee Y, Rio DC: Mechanisms and regulation of alternative pre-mRNA splicing. *Ann Rev Biochem* 2015;84:291-323.
- Miguel-Escalada I, Pasquali L, Ferrer J: Transcriptional enhancers: functional insights and role in human disease. *Curr Opin Genet Dev* 2015;33:71-76.
- Niederriter AR, Varshney A, Parker SC, Martin DM: Super enhancers in cancers, complex disease, and developmental disorders. *Genes* 2015;6:1183-1200.
- Nogales E, Louder RK, He Y: Cryo-EM in the study of challenging systems: the human transcription pre-initiation complex. *Curr Opin Struc Biol* 2016;40:120-127.
- Proudfoot NJ: Transcriptional termination in mammals: stopping the RNA polymerase II juggernaut. *Science* 2016;352:aad9926.
- Sentenac A, Riva M: Odd RNA polymerases or the A(B)C of eukaryotic transcription. *Biochim Biophys Acta* 2013;1829:251-257.
- Takizawa Y, Binshtein E, Erwin AL, Pyburn TM, Mittendorf KF, Ohi MD: While the revolution will not be crystallized, biochemistry reigns supreme. *Prot Sci* 2017;26:69-81.
- Venkatesh S, Workman JL: Histone exchange, chromatin structure and the regulation of transcription. *Nat Rev Mol Cell Biol* 2015;16:178-189.
- Zhang Q, Lenardo MJ, Baltimore D: 30 years of NF- κ B: a blossoming of relevance to human pathobiology. *Cell* 2017;168:37-57.

Protein Synthesis & the Genetic Code

P. Anthony Weil, PhD

OBJECTIVES

After studying this chapter, you should be able to:

- Understand that the genetic code is a three-letter nucleotide code, which is contained within the linear array of the exon DNA (composed of triplets of A, G, C, and T) of protein coding genes, and that this three-letter code is translated into mRNA (composed of triplets of A, G, C, and U) to specify the linear order of amino acid addition during protein synthesis via the process of translation.
- Appreciate that the universal genetic code is degenerate, unambiguous, nonoverlapping, and punctuation free.
- Explain that the genetic code is composed of 64 codons, 61 of which encode amino acids while 3 induce the termination of protein synthesis.
- Describe how the transfer RNAs (tRNAs) serve as the ultimate informational agents that decode the genetic code of messenger RNAs (mRNAs).

- Understand the mechanism of the energy-intensive process of protein synthesis that occurs on RNA-protein complexes termed ribosomes.
- Appreciate that protein synthesis, like DNA replication and transcription, is precisely controlled through the action of multiple accessory factors that are responsive to multiple extra- and intracellular regulatory signaling inputs.

BIOMEDICAL IMPORTANCE

The letters A, G, T, and C correspond to the nucleotides found in DNA. Within the protein-coding genes, these nucleotides are organized into three-letter code words called **codons**, and the collection of these codons, once transcribed into mRNA, makes up the **genetic code**. It was impossible to understand protein synthesis—or to explain mutations—before the genetic code was elucidated. The code provides a foundation for explaining the way in which protein defects may cause genetic disease and for the diagnosis and perhaps the treatment of these disorders. In addition, the pathophysiology of many viral infections is related to the ability of these infectious agents to disrupt host cell protein synthesis. Many antibacterial drugs are effective because they selectively disrupt protein synthesis in the invading bacterial cell but do not affect protein synthesis in eukaryotic cells.

GENETIC INFORMATION FLOWS FROM DNA TO RNA TO PROTEIN

The genetic information within the nucleotide sequence of DNA is transcribed in the nucleus into the specific nucleotide sequence of an mRNA molecule. The sequence of nucleotides in the RNA transcript is complementary to the nucleotide sequence of the template strand of its gene in accordance with the base-pairing rules. Several different classes of RNA combine to direct the synthesis of proteins.

In prokaryotes there is a linear correspondence between the gene, the **messenger RNA (mRNA)** transcribed from the gene, and the polypeptide product. The situation is more complicated in higher eukaryotic cells, in which the primary transcript is much larger than the mature mRNA. The large mRNA precursors contain coding regions (**exons**) that will form the mature mRNA and long intervening sequences (**introns**) that separate the

exons. The mRNA is processed within the nucleus, and the introns, which make up much more of this RNA than the exons, are removed. Exons are spliced together to form mature mRNA, which is transported to the cytoplasm, where it is translated into protein (see [Chapter 36](#)).

The cell must possess the machinery necessary to translate information accurately and efficiently from the nucleotide sequence of an mRNA into the sequence of amino acids of the corresponding specific protein. Clarification of our understanding of this process, which is termed **translation**, awaited deciphering of the genetic code. It was realized early that mRNA molecules themselves have no affinity for amino acids and, therefore, that the translation of the information in the mRNA nucleotide sequence into the amino acid sequence of a protein requires an intermediate adapter molecule. This adapter molecule must recognize a specific nucleotide sequence on the one hand as well as a specific amino acid on the other. With such an adapter molecule, the cell can direct a specific amino acid into the proper sequential position of a protein during its synthesis as dictated by the nucleotide sequence of the specific mRNA. In fact, the functional groups of the amino acids do not themselves actually come into contact with the mRNA template.

THE NUCLEOTIDE SEQUENCE OF AN mRNA MOLECULE CONTAINS A SERIES OF CODONS THAT SPECIFY THE AMINO ACID SEQUENCE OF THE ENCODED PROTEIN

Twenty different amino acids are required for the synthesis of the cellular complement of proteins; thus, there must be at least 20 distinct codons that make up the genetic code. Since there are only four different nucleotides in mRNA, each codon must consist of more than a single purine or pyrimidine nucleotide. Codons consisting of two nucleotides each could provide for only 16 (ie, 4^2) distinct codons, whereas codons of three nucleotides could provide 64 (4^3) specific codons.

It is now known that each codon consists of a sequence of three nucleotides; that is, **it is a triplet code** ([Table 37-1](#)). The initial deciphering of the **genetic code** depended heavily on in vitro synthesis of nucleotide polymers, particularly triplets in repeated sequence. These synthetic triplet ribonucleotides were used as mRNAs to program protein synthesis in the test tube, which allowed investigators to deduce the genetic code.

TABLE 37–1 The Genetic Code^a (Codon Assignments in Mammalian Messenger RNAs)

First Nucleotide	Second Nucleotide				Third Nucleotide
	U	C	A	G	
U	Phe	Ser	Tyr	Cys	U
	Phe	Ser	Tyr	Cys	C
	Leu	Ser	Term	Term ^b	A
	Leu	Ser	Term	Trp	G
C	Leu	Pro	His	Arg	U
	Leu	Pro	His	Arg	C
	Leu	Pro	Gln	Arg	A
	Leu	Pro	Gln	Arg	G
A	Ile	Thr	Asn	Ser	U
	Ile	Thr	Asn	Ser	C
	Ile ^a	Thr	Lys	Arg ^b	A
	Met	Thr	Lys	Arg ^b	G
G	Val	Ala	Asp	Gly	U
	Val	Ala	Asp	Gly	C
	Val	Ala	Glu	Gly	A
	Val	Ala	Glu	Gly	G

^aThe terms first, second, and third nucleotide refer to the individual nucleotides of a triplet codon read 5′-3′, left to right. A, adenine nucleotide; C, cytosine nucleotide; G, guanine nucleotide; Term, chain terminator codon; U, uridine nucleotide. AUG, which codes for Met, serves as the initiator codon in mammalian cells and also encodes for internal methionines in a protein. (Abbreviations of amino acids are explained in Chapter 3.)

^bIn mammalian mitochondria, AUA codes for Met and UGA for Trp, and AGA and AGG serve as chain terminators.

**THE GENETIC CODE IS DEGENERATE,
UNAMBIGUOUS, NONOVERLAPPING,
WITHOUT PUNCTUATION, & UNIVERSAL**

Three of the 64 possible codons do not code for specific amino acids; these have been termed **nonsense codons**. These nonsense codons are utilized in the cell as **translation termination signals**; they specify where the polymerization of amino acids into a protein molecule is to stop. The remaining 61 codons code for the 20 naturally occurring amino acids (Table 37–1). Thus, there is “**degeneracy**” in the genetic code—that is, multiple codons decode the same amino acid. Some amino acids are encoded by several codons; for example, six different codons, UCU, UCC, UCA, UCG, AGU, and AGC all specify serine. Other amino acids, such as methionine and tryptophan, have a single codon. In general, the third nucleotide in a codon is less important than the first two in determining the specific amino acid to be incorporated, and this accounts for most of the degeneracy of the code. However, for any specific codon, only a single amino acid is specified; with rare exceptions, the genetic code is **unambiguous**—that is, given a specific codon, only a single amino acid is indicated. The distinction between **ambiguity** and **degeneracy** is an important concept.

The unambiguous but degenerate code can be explained in molecular terms. The recognition of specific codons in the mRNA by the tRNA adapter molecules is dependent on the tRNA **anticodon region** and specific base-pairing rules that dictate tRNA–mRNA codon binding. Each tRNA molecule contains a specific sequence, complementary to a codon, which is termed its anticodon. For a given codon in the mRNA, only a single species of tRNA molecule possesses the proper anticodon. Since each tRNA molecule can be charged with only one specific amino acid, each codon therefore specifies only one amino acid. However, some tRNA molecules can utilize the anticodon to recognize more than one codon. With few exceptions, given a specific codon, only a specific amino acid will be incorporated—although, given a specific amino acid, more than one codon may be used.

As discussed below, the reading of the genetic code during the process of protein synthesis does not involve any overlap of codons. Thus, the genetic code is **nonoverlapping**. Furthermore, once the reading is commenced at a specific start codon, there is **no punctuation** between codons, and the message is read in a continuing sequence of nucleotide triplets until a translation stop codon is reached.

Until recently, the genetic code was thought to be universal. It has now been shown that the set of tRNA molecules in mitochondria (which contain their own separate and distinct set of translation machinery) from lower and higher eukaryotes, including humans, reads four codons

differently from the tRNA molecules in the cytoplasm of even the same cells. As noted in a footnote to [Table 37–1](#), in mammalian mitochondria the codon AUA is read as Met, and UGA codes for Trp. In addition, in mitochondria, the codons AGA and AGG are read as stop or chain terminator codons rather than as Arg. As a result of these organelle-specific changes in genetic code, mitochondria require only 22 tRNA molecules (see [Figure 35-8](#) for the location of these genes in mrDNA) to read their genetic code, whereas the cytoplasmic translation system possesses a full complement of 31 tRNA species. These exceptions noted, the genetic code is **universal**. The frequency of use of each amino acid codon varies considerably between species and among different tissues within a species. The specific tRNA levels generally mirror these codon usage biases. Thus, a particular abundantly used codon is decoded by a similarly abundant-specific tRNA which recognizes that particular codon. Tables of **codon usage** are quite accurate now that many genomes have been sequenced and such information is vital for large-scale production of proteins for therapeutic purposes (ie, insulin, erythropoietin). Such proteins are often produced in nonhuman cells using recombinant DNA technology (see [Chapter 39](#)). The main features of the genetic code are listed in [Table 37–2](#).

TABLE 37–2 Features of the Genetic Code

- Degenerate
- Unambiguous
- Nonoverlapping
- Not punctuated
- Universal

AT LEAST ONE SPECIES OF tRNA EXISTS FOR EACH OF THE 20 AMINO ACIDS

tRNA molecules have extraordinarily similar functions and three-dimensional structures. The adapter function of the tRNA molecules requires the charging of each specific tRNA with its specific amino acid. Since there is no affinity of nucleic acids for specific functional groups of amino acids, this recognition must be carried out by a protein molecule capable of recognizing both a specific tRNA molecule and a specific amino acid. At least 20 specific enzymes are required for these specific recognition functions and for the proper attachment of the 20 amino acids to specific tRNA molecules. This energy requiring process of recognition

and attachment, **tRNA amino acid charging**, proceeds in two steps and is catalyzed by one enzyme for each of the 20 amino acids. These enzymes are termed **aminoacyl-tRNA synthetases**. They form an activated intermediate of aminoacyl-AMP–enzyme complex (**Figure 37–1**). The specific aminoacyl-AMP–enzyme complex then recognizes a specific tRNA to which it attaches the aminoacyl moiety at the 3'-hydroxyl adenosyl terminal. The charging reactions have an error rate of less than 10^{-4} and so are quite accurate. The amino acid remains attached to its specific tRNA in an ester linkage until it is incorporated at a specific position during the synthesis of a polypeptide on the ribosome.

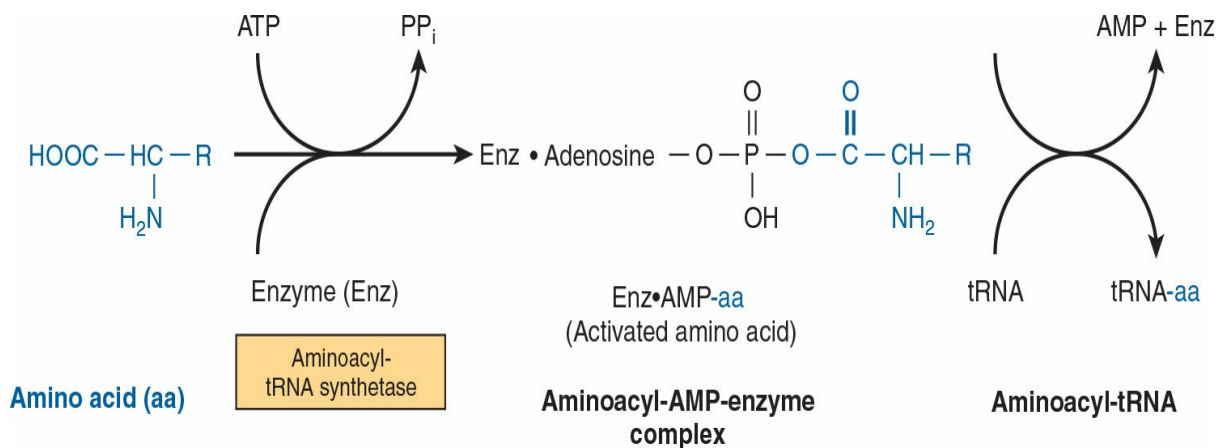

FIGURE 37–1 Formation of aminoacyl-tRNA. A two-step reaction, involving the enzyme aminoacyl-tRNA synthetase, results in the formation of aminoacyl-tRNA. The first reaction involves the formation of an AMP-amino acid–enzyme complex. This activated amino acid is next transferred to the corresponding tRNA molecule. The AMP and enzyme are released, and the latter can be reutilized. The charging reactions have an error rate (ie, esterifying the incorrect amino acid on tRNA^{XXX}) of less than 1 mischarging event out of 10^4 amino acid charging events.

The regions of the tRNA molecule referred to in **Chapter 34** (and illustrated in **Figure 34–11**) now become important. The **ribothymidine pseudouridine cytidine (T ψ C) arm** is involved in binding of the aminoacyl-tRNA to the ribosomal surface at the site of protein synthesis. The **tRNA D arm** is one of the sites important for the proper recognition of a given tRNA species by its proper aminoacyl-tRNA synthetase. The **tRNA acceptor arm**, located at the 3'-hydroxyl adenosyl terminal, is the site of attachment of the specific amino acid.

The anticodon region (arm) consists of seven nucleotides, and it

recognizes the three-letter codon in mRNA (**Figure 37–2**). The sequence read from the 3' to 5' direction in that anticodon loop consists of a variable base (N)–modified purine (Pu^{*})–XYZ (the anticodon)–pyrimidine (Py)–pyrimidine (Py)–5'. Note that this direction of reading the anticodon is 3'–5', whereas the genetic code in **Table 37–1** is read 5'–3', since the codon and the anticodon loop of the mRNA and tRNA molecules, respectively, are antiparallel in their complementarity just like all other intermolecular interactions between nucleic acid strands.

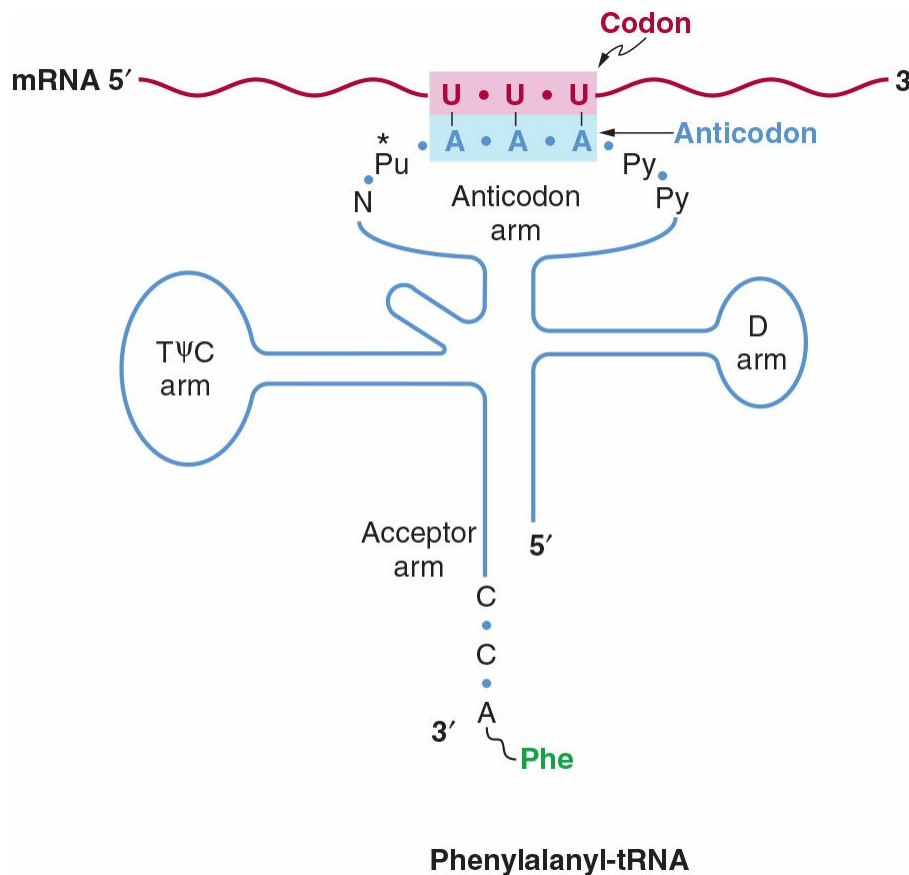

FIGURE 37–2 Recognition of the codon by the anticodon. One of the codons for phenylalanine is UUU. tRNA charged with phenylalanine (Phe) has the complementary sequence AAA; hence, it forms a base-pair complex with the codon. The anticodon region (arm) typically consists of a sequence of seven nucleotides: variable (N), modified purine (Pu^{*}), X, Y, Z (here, A A A), and two pyrimidines (Py) in the 3' to 5' direction.

The degeneracy of the genetic code resides mostly in the last nucleotide of the codon triplet, suggesting that the base pairing between this last nucleotide and the corresponding nucleotide of the anticodon is not strictly by the Watson-Crick rule. This is called **wobble**; the pairing of the codon

and anticodon can “wobble” at this specific nucleotide-to-nucleotide pairing site. For example, the two codons for arginine, AGA and AGG, can bind to the same anticodon having an uracil at its 5' end (UCU). Similarly, three codons for glycine—GGU, GGC, and GGA—can form a base pair from one anticodon, 3' CCI 5' (ie, I, inosine, can base pair with U, C, and A). Inosine is generated by deamination of adenine (see [Figure 33–2](#) for structure).

MUTATIONS RESULT WHEN CHANGES OCCUR IN THE NUCLEOTIDE SEQUENCE

Although the initial change may not occur in the template strand of the double-stranded DNA molecule for that gene, after replication, daughter DNA molecules with mutations in the template strand will segregate and appear in the population of organisms.

Some Mutations Occur by Base Substitution

Single-base changes (**point mutations**) may be **transitions** or **transversions**. In the former, a given pyrimidine is changed to the other pyrimidine or a given purine is changed to the other purine. Transversions are changes from a purine to either of the two pyrimidines or the change of a pyrimidine into either of the two purines, as shown in [Figure 37–3](#).

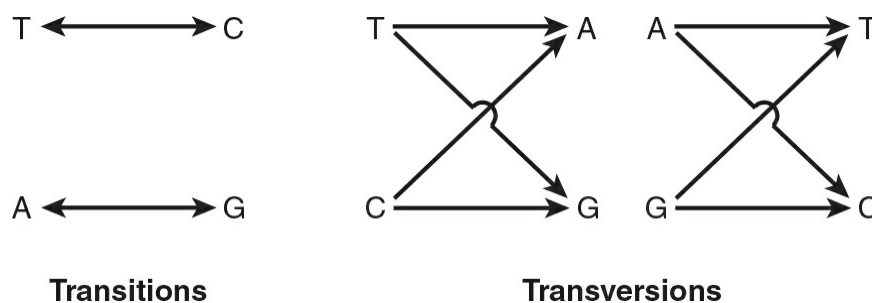

FIGURE 37–3 Diagrammatic representation of transition and transversion mutations.

When the nucleotide sequence of a protein-coding gene containing the mutation is transcribed into an mRNA molecule, then the RNA molecule will of course possess the base change at the corresponding location.

Single-base changes in the mRNA may have one of several effects when translated into protein:

1. There may be no detectable effect because of the degeneracy of the

code; such mutations are often referred to as **silent mutations**. This would be most likely if the changed base in the mRNA molecule were to be at the third nucleotide of a codon. Because of wobble, the translation of a codon is least sensitive to a change at the third position.

2. A **missense effect** will occur when a different amino acid is incorporated at the corresponding site in the protein molecule. This mistaken amino acid—or missense, depending on its location in the specific protein—might be acceptable, partially acceptable, or unacceptable to the function of that protein molecule. From a careful examination of the genetic code, one can conclude that most single-base changes would result in the replacement of one amino acid by another with rather similar functional groups. This is an effective genetic “buffering” mechanism to avoid drastic change in the physical properties of a protein molecule. If an acceptable missense effect occurs, the resulting protein molecule may not be distinguishable from the normal one. A partially acceptable missense will result in a protein molecule with partial but abnormal function. If an unacceptable missense effect occurs, then the protein molecule will not be capable of functioning normally.
3. A **nonsense** codon may appear that would then result in the **premature termination** of translation and the production of only a fragment of the intended protein molecule. The probability is high that a prematurely terminated protein molecule or peptide fragment will not function in its normal role. Examples of the different types of mutations, and their effects on the coding potential of mRNA are presented in **Figures 37–4** and **37–5**.

	Protein molecule	Amino acid	Codons
Acceptable missense	Hb A, β chain ↓ Hb Hikari, β chain	61 Lysine ↓ Asparagine	AAA or AAG ↓ ↓ AAU or AAC
Partially acceptable missense	Hb A, β chain ↓ Hb S, β chain	6 Glutamate ↓ Valine	GAA or GAG ↓ ↓ GUA or GUG
Unacceptable missense	Hb A, α chain ↓ Hb M (Boston), α chain	58 Histidine ↓ Tyrosine	CAU or CAC ↓ ↓ UAU or UAC

FIGURE 37–4 Examples of three types of missense mutations resulting in abnormal hemoglobin chains. The amino acid alterations and possible alterations in the respective codons are indicated. The hemoglobin Hikari β -chain mutation has apparently normal physiologic properties but is electrophoretically altered. Hemoglobin S has a β -chain mutation and partial function; hemoglobin S binds oxygen but precipitates when deoxygenated; this causes red blood cells to sickle, and represents the cellular and molecular basis of sickle cell disease (see [Figure 6–13](#)). Hemoglobin M Boston, an α -chain mutation, permits the oxidation of the heme ferrous iron to the ferric state and so will not bind oxygen at all.

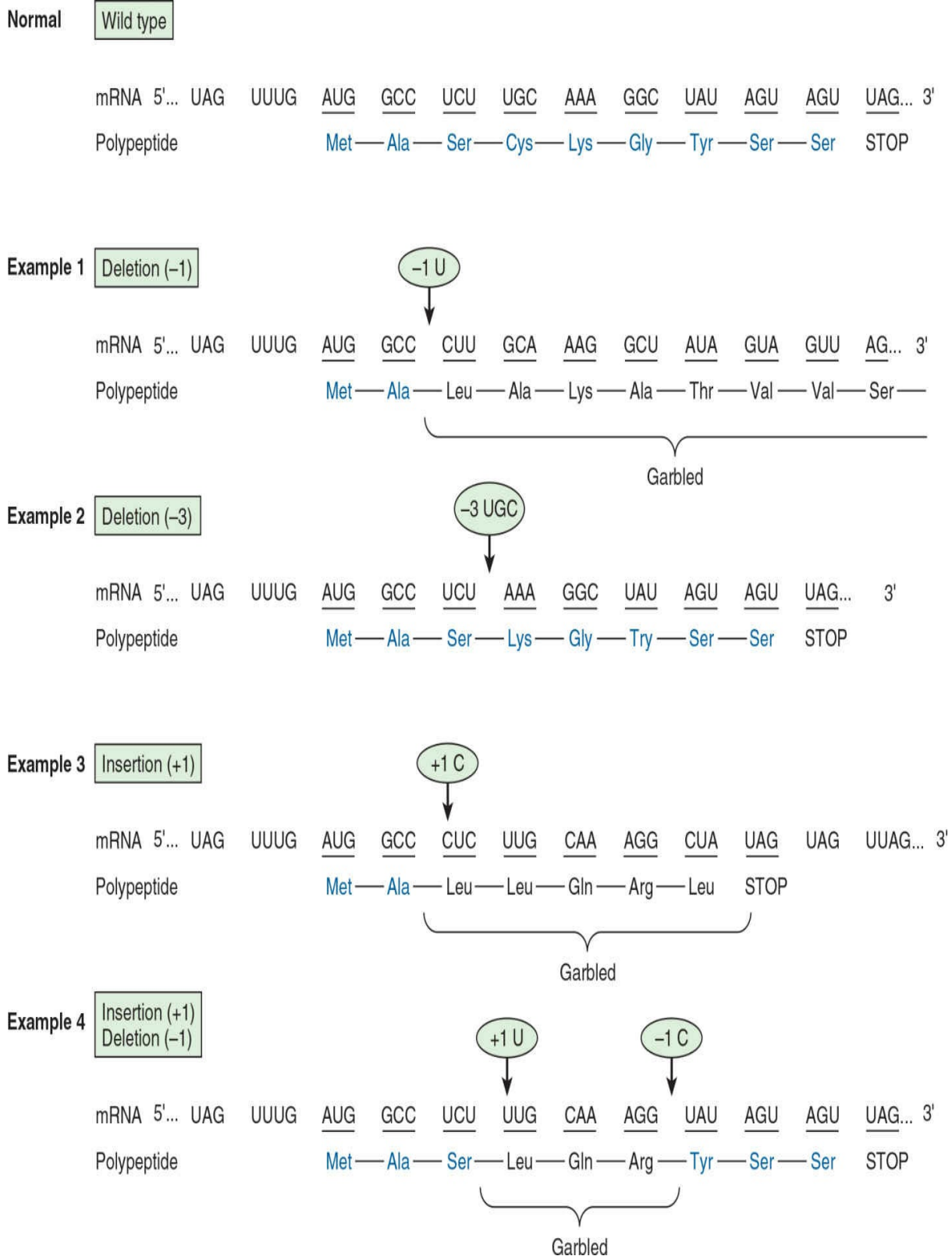

FIGURE 37–5 Examples of the effects of deletions and insertions in a gene on the sequence of the mRNA transcript and of the polypeptide chain translated therefrom. The arrows indicate the sites of deletions or insertions, and the numbers in the ovals indicate the number of nucleotide

residues deleted or inserted. Colored type indicates the correct amino acids in the correct order.

Frameshift Mutations Result From Deletion or Insertion of Nucleotides in DNA That Generates Altered mRNAs

The deletion of a single nucleotide from the coding strand of a gene results in an altered reading frame in the mRNA. The machinery translating the mRNA does not recognize that a base was missing, since there is no punctuation in the reading of codons. Thus, a major alteration in the sequence of polymerized amino acids, as depicted in example 1, [Figure 37–5](#), results. Altering the reading frame results in a garbled translation of the mRNA distal to the single nucleotide deletion. Not only is the sequence of amino acids distal to this deletion garbled, but reading of the message can also result in the appearance of a nonsense codon and thus the production of a polypeptide both garbled and prematurely terminated (example 3, [Figure 37–5](#)).

If three nucleotides or a multiple of three nucleotides are deleted from a coding region, translation of the corresponding mRNA will generate a protein that is missing the corresponding number of amino acids (example 2, [Figure 37–5](#)). Because the reading frame is a triplet, the reading phase will not be disturbed for those codons distal to the deletion. If, however, deletion of one or two nucleotides occurs just prior to or within the normal termination codon (nonsense codon), the reading of the normal termination signal is disturbed. Such a deletion might result in reading through the now “mutated” termination signal until another nonsense codon is encountered (not shown here).

Insertions of one or two or nonmultiples of three nucleotides into a gene result in an mRNA in which the reading frame is distorted upon translation, and the same effects that occur with deletions are reflected in the mRNA translation. This may result in garbled amino acid sequences distal to the insertion and the generation of a **nonsense codon** at, or distal to the insertion, or perhaps reading through the normal termination codon. Following a deletion in a gene, an insertion (or vice versa) can reestablish the proper reading frame (example 4, [Figure 37–5](#)). The corresponding mRNA, when translated, would contain a garbled amino acid sequence between the insertion and deletion. Beyond the reestablishment of the reading frame, the amino acid sequence would be correct. One can

imagine that different combinations of **insertions or deletions** (ie, **indels**), or of both would result in formation of a protein wherein a portion is abnormal, but this portion is surrounded by the normal amino acid sequences. Such phenomena have been demonstrated convincingly in a number of human diseases.

Suppressor Mutations Can Counteract Some of the Effects of Missense, Nonsense, & Frameshift Mutations

The above discussion of the altered protein products of gene mutations is based on the presence of normally functioning tRNA molecules. However, in prokaryotic and lower eukaryotic organisms, abnormally functioning tRNA molecules have been discovered that are themselves the results of mutations. Some of these abnormal tRNA molecules are capable of binding to and decoding altered codons, thereby suppressing the effects of mutations in distinct mutated mRNA-encoding structural genes. These **suppressor tRNA molecules**, usually formed as a result of alterations in their anticodon regions, are capable of suppressing certain missense mutations, nonsense mutations, and frameshift mutations. However, since the suppressor tRNA molecules are not capable of distinguishing between a normal codon and one resulting from a gene mutation, their presence in the cell usually results in decreased viability. For instance, the nonsense suppressor tRNA molecules can suppress the normal termination signals to allow a read-through when it is not desirable. Frameshift suppressor tRNA molecules may read a normal codon plus a component of a juxtaposed codon to provide a frameshift, also when it is not desirable. Suppressor tRNA molecules may exist in mammalian cells, since read-through of translation has on occasion been observed. In the laboratory context, such suppressor tRNAs, coupled with mutated variants of aminoacyl-tRNA synthetases, can be utilized to incorporate unnatural amino acids into defined locations within altered genes that carry engineered nonsense mutations. The resulting labeled proteins can be used for in vivo and in vitro cross-linking and biophysical studies. This new tool adds significantly to biologists interested in studying the mechanisms of a wide range of biologic processes.

LIKE TRANSCRIPTION, PROTEIN SYNTHESIS CAN BE DESCRIBED IN THREE PHASES:

INITIATION, ELONGATION, & TERMINATION

The general structural characteristics of ribosomes are discussed in [Chapter 34](#). These particulate entities serve as the machinery on which the mRNA nucleotide sequence is translated into the sequence of amino acids of the specified protein. The translation of the mRNA commences near its 5' end with the formation of the corresponding amino terminus of the protein molecule. The message is decoded from 5' to 3', concluding with the formation of the carboxyl terminus of the protein. Again, the concept of **polarity** is apparent. As described in [Chapter 36](#), the transcription of a gene into the corresponding mRNA or its precursor first forms the 5' end of the RNA molecule. In prokaryotes, this allows for the beginning of mRNA translation before the transcription of the gene is completed. In eukaryotic organisms, the process of transcription is a nuclear one, while mRNA translation occurs in the cytoplasm, precluding simultaneous transcription and translation in eukaryotic organisms and enabling the processing necessary to generate mature mRNA from the primary transcript.

Initiation Involves Several Protein-RNA Complexes

Initiation of eukaryotic protein synthesis requires that an mRNA molecule be selected for translation by a ribosome ([Figure 37–6](#)). Once the mRNA binds to the ribosome, the ribosome must locate the initiation codon thereby setting the correct reading frame on the mRNA, and translation begins. This process involves tRNA, rRNA, mRNA, and at least **10 eukaryotic initiation factors (eIFs)**, some of which have multiple (three to eight) subunits. Also involved are GTP, ATP, and amino acids. Initiation can be divided into three steps, all of which are obligatorily preceded by dissociation of the 80S ribosome into its constituent 40S and 60S subunits: (1) binding of a ternary complex consisting of the **initiator methionyl-tRNA, (met-tRNAⁱ)**, GTP, and **eIF-2** to the 40S ribosome to form the **43S preinitiation complex**; (2) binding of mRNA to the 40S preinitiation complex to form the **48S initiation complex**; and (3) combination of the 48S initiation complex with the 60S ribosomal subunit to form the **80S initiation complex**.

**1. Re-formation of the 80S initiation complex:
Dissociation of the ribosome**

2. Ternary complex formation

3. Activation of mRNA

4. Active 80S complex

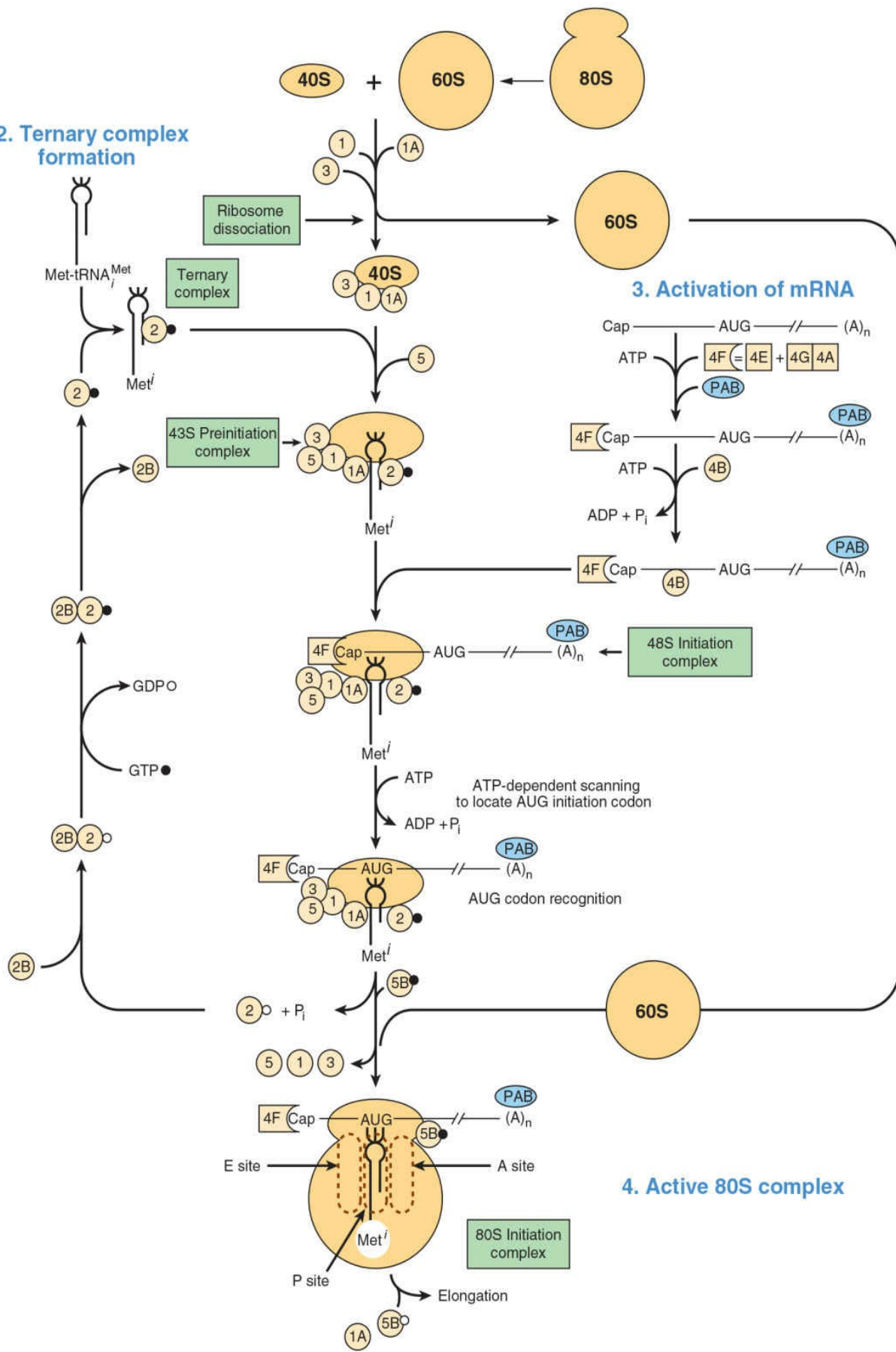

FIGURE 37–6 Diagrammatic representation of the initiation phase of protein synthesis on an eukaryotic mRNA. Eukaryotic mRNAs contain a 5' ⁷meG-cap (Cap) and 3' poly(A) terminal [(A)_n] as shown. Translation preinitiation complex formation proceeds in several steps: (1) Dissociation of the 80S complex to component 40S and 60S subunits, a process facilitated by binding of factors eIF1, eIF1A, and eIF3 to the ribosomal 40S subunit (top). (2) Formation of the 43S Preinitiation Complex, a ternary complex consisting of met-tRNA_i and GTP-bound to the initiation factor eIF-2 (eIF-2-GTP; left). This complex is then bound by the eIF5 initiation factor forming the complete 43S Preinitiation Complex. (3) Activation of 'capped' mRNA and formation of the 48S Initiation Complex. mRNA is bound via its 5'-Cap by eIF4F (composed of eIF4E, eIF4G and eIF4A factors) and 3' Poly(A) tail by Poly A Binding Protein forming the 48S Initiation Complex. ATP hydrolysis-dependent 5' to 3' mRNA scanning enables location of the initiation codon AUG, which is then bound by met-tRNA_i. (4) Following addition of GTP-bound eIF5 and dissociation of eIF1, eIF2-GDP, eIF3 and eIF5, formation of the 80S Initiation Complex occurs when a recycled 60S ribosomal subunit joins the 48S complex. This reaction positions the initiator met-tRNA_i within the P-Site of the active 80S Initiation Complex formation induces dissociation of eIF1A and GDP-bound eIF5B (see text for details). This complex is now competent for translation initiation. (GTP, •; GDP, °) The various initiation factors appear in abbreviated form as circles or squares, for example, eIF-3, (③), eIF-4F, (4F), (4F). 4•F is a complex consisting of 4E and 4A bound to 4G (see Figure 37–7). Note that the “circular” structure of mRNA illustrated in Figure 37–7 is thought to be the actual form of mRNA upon which steps 1 to 4 actually occur.

Ribosomal Dissociation

Prior to initiation, 80S ribosomes dissociate into component 40S and 60S subunits during translation termination (see below). Dissociation allows these components to participate in subsequent rounds of translation. Two initiation factors, **eIF-3**, **eIF-1**, and **eIF-1A**, bind to the newly dissociated 40S ribosomal subunit. This delays its reassociation with the 60S subunit and allows other translation initiation factors to associate with the 40S subunit.

Formation of the 43S Preinitiation Complex

The first step of translation initiation involves the binding of GTP by eIF-2. This binary complex then binds to **methionyl tRNAⁱ**, a tRNA specifically involved in binding to the initiation codon AUG. It is important to note that there are two tRNAs for methionine. One specifies methionine for the initiator codon, the other for internal methionines. Each has a unique nucleotide sequence; both are aminoacylated by the same methionyl-tRNA synthetase. The GTP-eIF-2-tRNAⁱ ternary complex binds to the 40S ribosomal subunit to form the 43S preinitiation complex. The ternary complex–40S subunit complex is stabilized by eIF-3 and eIF-1A and the subsequent binding of **eIF5**.

eIF-2 is one of two control points for protein synthesis initiation in eukaryotic cells. eIF-2 consists of α , β , and γ subunits. **eIF-2 α is phosphorylated** (on serine 51) by at least **four different protein kinases (HCR, PKR, PERK, and GCN2)** that are activated when a cell is under stress and when the energy expenditure required for protein synthesis would be deleterious. Such conditions include amino acid or glucose starvation, virus infection, intracellular presence of large quantities of misfolded proteins (endoplasmic reticulum [ER] stress), serum deprivation, hyperosmolality, and heat shock. PKR is particularly interesting in this regard. This kinase is activated by viruses and provides a host defense mechanism that decreases protein synthesis, including viral protein synthesis, thereby inhibiting viral replication. Phosphorylated eIF-2 α binds tightly to and inactivates the GTP–GDP recycling protein eIF-2B, thus, preventing formation of the 43S preinitiation complex and blocking protein synthesis.

Formation of the 48S Initiation Complex

As described in [Chapter 36](#), the 5' termini of mRNA molecules in eukaryotic cells are “capped.” The ⁷meG-cap facilitates the binding of mRNA to the 43S preinitiation complex. A **cap-binding protein complex, eIF-4F (4F)**, which consists of **eIF-4E (4E)** and the **eIF-4G (4G)-eIF-4A (4A) complex**, binds to the cap through the 4E protein. Then **eIF-4B (4B)** binds and reduces the complex secondary structure of the 5' end of the mRNA through its ATP-dependent helicase activity. The association of mRNA with the 43S preinitiation complex to form the 48S initiation complex requires ATP hydrolysis. eIF-3 is a key protein because it binds with high affinity to the 4G component of 4F, and it links this complex to the 40S ribosomal subunit. Following association of the 43S preinitiation complex with the mRNA cap, and reduction (“melting”) of the secondary

structure near the 5' end of the mRNA through the action of the 4B helicase and ATP, the complex translocates 5' → 3' and scans the mRNA for a suitable initiation codon. Generally, this is the 5'-most AUG, but the precise initiation codon is determined by so-called **Kozak consensus sequences** that surround the **AUG** initiation codon:



Most preferred is the presence of a purine (Pu) at positions -3 and a G at position +4.

Role of the Poly(A) Tail in Initiation

Biochemical and genetic experiments have revealed that the 3' poly(A) tail and the **poly(A) binding protein, PAB**, are both required for efficient initiation of protein synthesis. Further studies showed that the poly(A) tail stimulates recruitment of the 40S ribosomal subunit to the mRNA through a complex set of interactions. PAB (**Figure 37-7**) bound to the poly(A) tail, interacts with eIF-4G, and 4E subunits of cap-bound eIF-4F to form a circular structure that helps direct the 40S ribosomal subunit to the 5' end of the mRNA and also likely stabilizes mRNAs from exonucleolytic degradation. This helps explain how the cap and poly(A) tail structures have a synergistic effect on protein synthesis. Indeed, differential protein-protein interactions between general and specific mRNA translational repressors and eIF-4E result in m⁷G cap-dependent translation control (**Figure 37-8**).

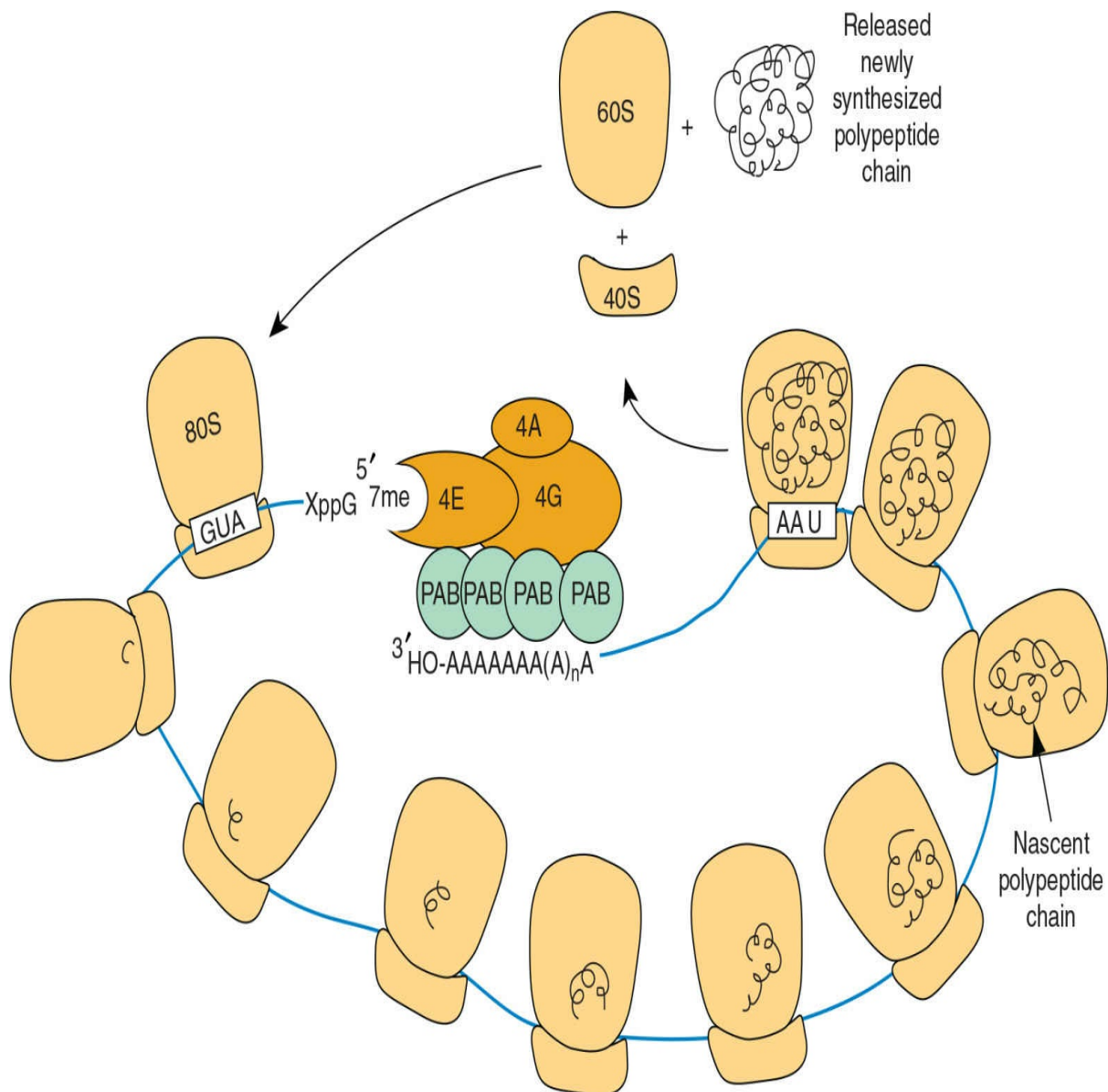

FIGURE 37–7 Schematic illustrating the circularization of mRNA through protein–protein interactions between 7meG cap-bound eIF4F and poly(A) tail-bound poly(A) binding protein. eIF4F, composed of eIF4A, 4E, and 4G subunits binds the mRNA 5′-7meG “Cap” (7meGpppX-) upstream of the translation initiation codon (AUG) with high affinity. The eIF4G subunit of the complex also binds poly(A) binding protein (PAB) with high affinity. Since PAB is bound tightly to the mRNA 3′-poly(A) tail (5′-(X)_nA(A)_n AAAAAAA_{OH} 3′), circularization results. Shown are multiple 80S ribosomes that are in the process of translating the circularized mRNA into protein (black curlicues), forming a polysome. Upon encountering a termination codon (here UAA), translation termination occurs leading to release of the newly translated protein and dissociation of the 80S ribosome into 60S, 40S subunits. Dissociated

ribosomal subunits can recycle through another round of translation (see [Figure 37–6](#) and [37-10](#)).

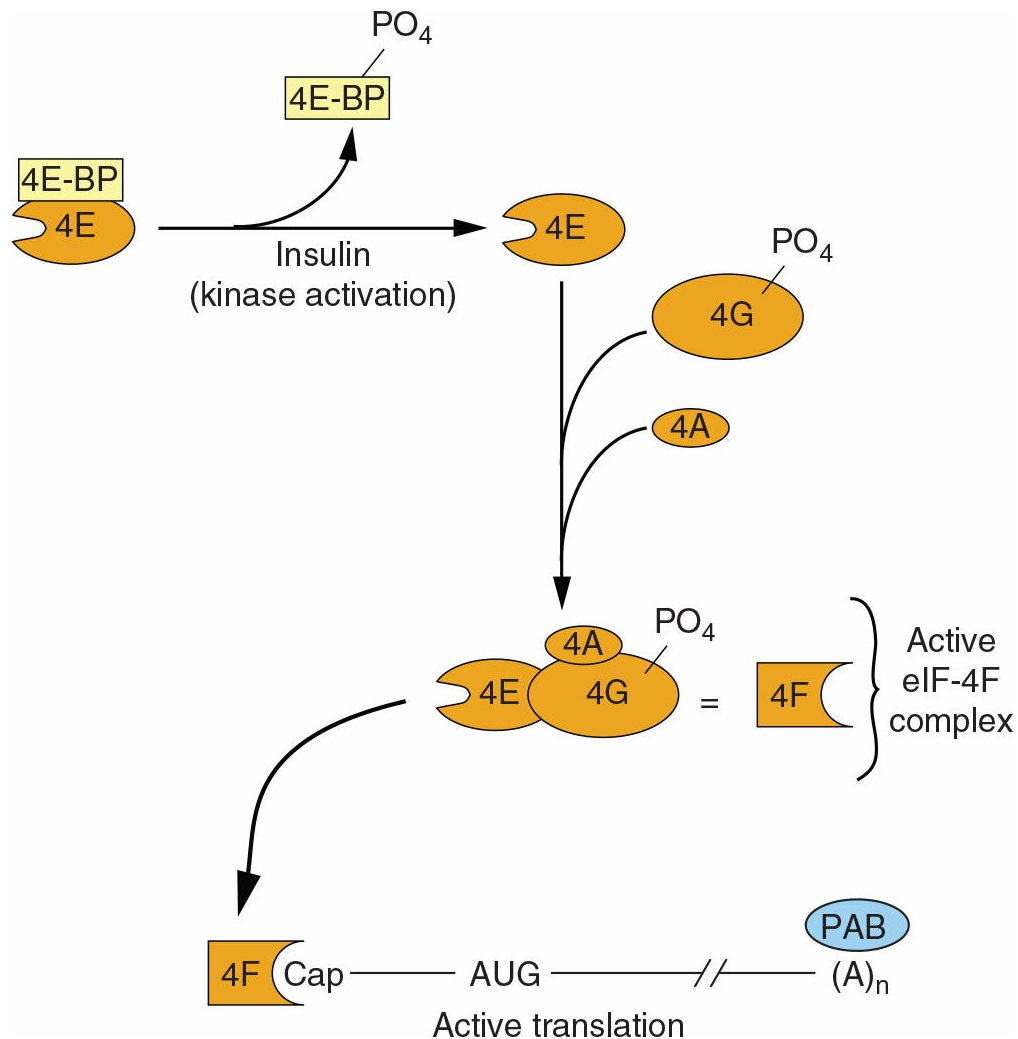

FIGURE 37–8 Activation of eIF-4E by insulin and formation of the cap-binding eIF-4F complex. The 4F-cap mRNA complex is depicted as in [Figures 37–6](#) and [37–7](#). The 4F complex consists of eIF-4E (4E), eIF-4A, and eIF-4G. 4E is inactive when bound by one of a family of binding proteins (4E-BPs). Insulin and mitogenic growth polypeptides, or growth factors (eg, IGF-1, PDGF, interleukin-2, and angiotensin II) activate the PI3 kinase/AKT kinase signaling pathways, which activate the mTOR kinase, and results in the phosphorylation of 4E-BP (see [Figure 42–8](#)). Phosphorylated 4E-BP dissociates from 4E, and the latter is then able to form the 4F complex and bind to the mRNA cap. These growth polypeptides also induce phosphorylation of 4G itself by the mTOR and MAP kinase pathways (see [Chapter 42](#)). Phosphorylated 4F binds much more avidly to the cap than does nonphosphorylated 4F, which stimulates 48S initiation complex formation and hence translation.

Formation of the 80S Initiation Complex

The binding of the 60S ribosomal subunit to the 48S initiation complex involves hydrolysis of the GTP bound to eIF-2 by **eIF-5**. This reaction results in release of the initiation factors bound to the 48S initiation complex (these factors then are recycled) and the rapid association of the 40S and 60S subunits to form the 80S ribosome. At this point, the met-tRNAⁱ is on the P site of the ribosome, ready for the elongation cycle to commence.

The Regulation of eIF-4E Controls the Rate of Initiation

The 4F complex is particularly important in controlling the rate of protein translation. As described above, 4F is a complex consisting of 4E, which binds to the m⁷G cap structure at the 5' end of the mRNA, and 4G, which serves as a scaffolding protein. In addition to binding 4E, 4G binds to eIF-3, which links the complex to the 40S ribosomal subunit. It also binds 4A and 4B, the ATPase-helicase complex that helps unwind the RNA ([Figure 37-8](#)).

4E is responsible for recognition of the mRNA cap structure, a rate-limiting step in translation. This process is further regulated by phosphorylation ([Figure 37-8](#)). Insulin and mitogenic growth factors result in the phosphorylation of 4E on Ser209 (or Thr210). Phosphorylated 4E binds to the cap much more avidly than does the nonphosphorylated form, thus enhancing the rate of initiation. Components of the MAP kinase, PI3K, mTOR, RAS, and S6 kinase signaling pathways (see [Figure 42-8](#)) can all, under appropriate conditions, be involved in these regulatory phosphorylation reactions.

The activity of 4E is modulated in a second way, and this also involves phosphorylation; a set of proteins bind to and inactivate 4E. These proteins include **4E-BP1 (BP1)**, also known as **PHAS-1** and the closely related proteins **4E-BP2** and **4E-BP3**. BP1 binds with high affinity to 4E. The 4E-BP1 association prevents 4E from binding to 4G (to form 4F). Since this interaction is essential for the binding of 4F to the ribosomal 40S subunit and for correctly positioning it on the capped mRNA, BP-1 effectively inhibits translation initiation.

Insulin and other growth factors result in the phosphorylation of BP-1 at seven unique sites. Phosphorylation of BP-1 results in its dissociation from 4E, and it cannot rebind until critical sites are dephosphorylated.

These effects on the activation of 4E explain in part how insulin causes a marked posttranscriptional increase of protein synthesis in liver, adipose, and muscle tissue.

Elongation Is Also a Multistep, Accessory Factor-Facilitated Process

Elongation is a cyclic process on the ribosome in which one amino acid at a time is added to the nascent peptide chain (**Figure 37–9**). The peptide sequence is determined by the order of the codons in the mRNA.

Elongation involves several steps catalyzed by proteins called **elongation factors (EFs)**. These steps are (1) binding of aminoacyl-tRNA to the A site, (2) peptide bond formation, (3) translocation of the ribosome on the mRNA, and (4) expulsion of the deacylated tRNA from the P- and E-sites.

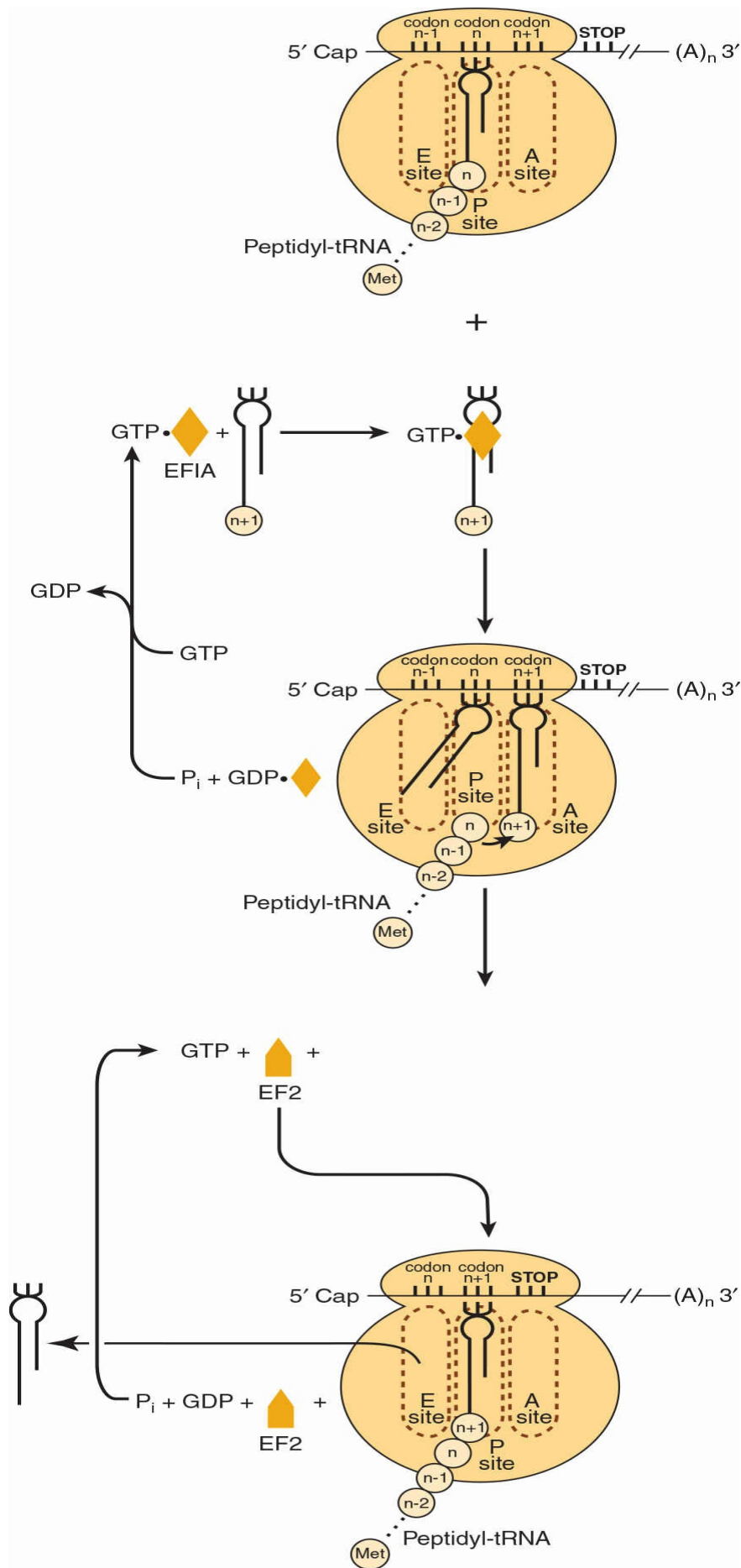

FIGURE 37–9 Diagrammatic representation of the peptide elongation process of protein synthesis. The small circles labeled $n - 1$, n , $n + 1$, etc, represent the amino acid residues of the newly formed protein molecule (in N-terminal to C-terminal orientation) and the corresponding codons in the mRNA. EF1A and EF2 represent elongation factors 1 and 2, respectively. The peptidyl-tRNA, aminoacyl-tRNA, and exit sites on the ribosome are represented by P site, A site, and E site, respectively.

Binding of Aminoacyl-tRNA to the A Site

In the complete 80S ribosome formed during the process of initiation, both the **A site (aminoacyl or acceptor site)** and **E site (deacylated tRNA exit site)** are free (Figure 37–6). The binding of the appropriate aminoacyl-tRNA in the A site requires proper codon recognition. **Elongation factor 1A (EF1A)** forms a ternary complex with GTP and the entering aminoacyl-tRNA (Figure 37–9). This complex then allows the correct aminoacyl-tRNA to enter the A site with the release of EF1A-GDP and phosphate. GTP hydrolysis is catalyzed by an active site on the ribosome; hydrolysis induces a conformational change in the ribosome concomitantly increasing affinity for the tRNA. As shown in Figure 37–9, EF1A-GDP then recycles to EF1A-GTP with the aid of other soluble protein factors and GTP.

Peptide Bond Formation

The α -amino group of the new aminoacyl-tRNA in the A site carries out a nucleophilic attack on the esterified carboxyl group of the **peptidyl-tRNA** occupying the **P site (peptidyl or polypeptide site)**. At initiation, this site is occupied by the initiator met-tRNAⁱ. This reaction is catalyzed by a **peptidyl transferase**, a component of the 28S RNA of the 60S ribosomal subunit. This is another example of ribozyme activity and indicates an important—and previously unsuspected—direct role for RNA in protein synthesis (Table 37–3). Because the amino acid on the aminoacyl-tRNA is already “activated,” no further energy source is required for this reaction. The reaction results in attachment of the growing peptide chain to the tRNA in the A site.

TABLE 37–3 Evidence That rRNA Is a Peptidyl Transferase

- Ribosomes can make peptide bonds (albeit inefficiently) even when proteins are removed or inactivated.
- Certain parts of the rRNA sequence are highly conserved in all species.
- These conserved regions are on the surface of the RNA molecule.
- RNA can be catalytic in many other chemical reactions.
- Mutations that result in antibiotic resistance at the level of protein synthesis are more often found in rRNA than in the protein components of the ribosome.
- X-ray crystal structure of large subunit bound to tRNAs suggests detailed mechanism.

Translocation

The now deacylated tRNA is attached by its anticodon to the P site at one end and by its open 3' CCA tail to the E site on the large ribosomal subunit (middle portion of [Figure 37–9](#)). At this point, **elongation factor 2 (EF2)** binds to and displaces the peptidyl tRNA from the A site to the P site. In turn, the deacylated tRNA is on the E site, from which it leaves the ribosome. The EF2-GTP complex is hydrolyzed to EF2-GDP, effectively moving the mRNA forward by one codon and leaving the A site open for occupancy by another ternary complex of amino acid tRNA–EF1A-GTP and another cycle of elongation.

The charging of the tRNA molecule with the aminoacyl moiety requires the hydrolysis of an ATP to an AMP, equivalent to the hydrolysis of two ATPs to two ADPs and phosphates. The entry of the aminoacyl-tRNA into the A site results in the hydrolysis of one GTP to GDP. Translocation of the newly formed peptidyl-tRNA in the A site into the P site by EF2 similarly results in hydrolysis of GTP to GDP and phosphate. Thus, the energy requirements for the formation of one peptide bond include the equivalent of the hydrolysis of two ATP molecules to ADP and of two GTP molecules to GDP, or the hydrolysis of four high-energy phosphate bonds. A eukaryotic ribosome can incorporate as many as six amino acids per second; prokaryotic ribosomes incorporate as many as 18 per second. Thus, the energy requiring process of peptide synthesis occurs with great speed and accuracy until a termination codon is reached.

Termination Occurs When a Stop Codon Is Recognized

In comparison to initiation and elongation, termination is a relatively

simple process (**Figure 37–10**). After multiple cycles of elongation culminating in polymerization of the specific amino acids into a protein molecule, the stop or terminating codon of mRNA (UAA, UAG, UGA) appears in the A site. Normally, there is no tRNA with an anticodon capable of recognizing such a termination signal. **Releasing factor 1 (RF1)** recognizes that a stop codon resides in the A site (**Figure 37–10**). RF1 is bound by a complex consisting of **releasing factor 3 (RF3)** with bound GTP. This complex, with the peptidyl transferase, promotes hydrolysis of the bond between the peptide and the tRNA occupying the P site. Thus, a water molecule rather than an amino acid is added. This hydrolysis releases the protein and the tRNA from the P site. Upon hydrolysis and release, the 80S ribosome dissociates into its 40S and 60S subunits, which are then recycled (**Figure 37–7**). Therefore, the releasing factors are proteins that hydrolyze the peptidyl-tRNA bond when a stop codon occupies the A site. The mRNA is then released from the ribosome, which dissociates into its component 40S and 60S subunits, and another cycle can be repeated.

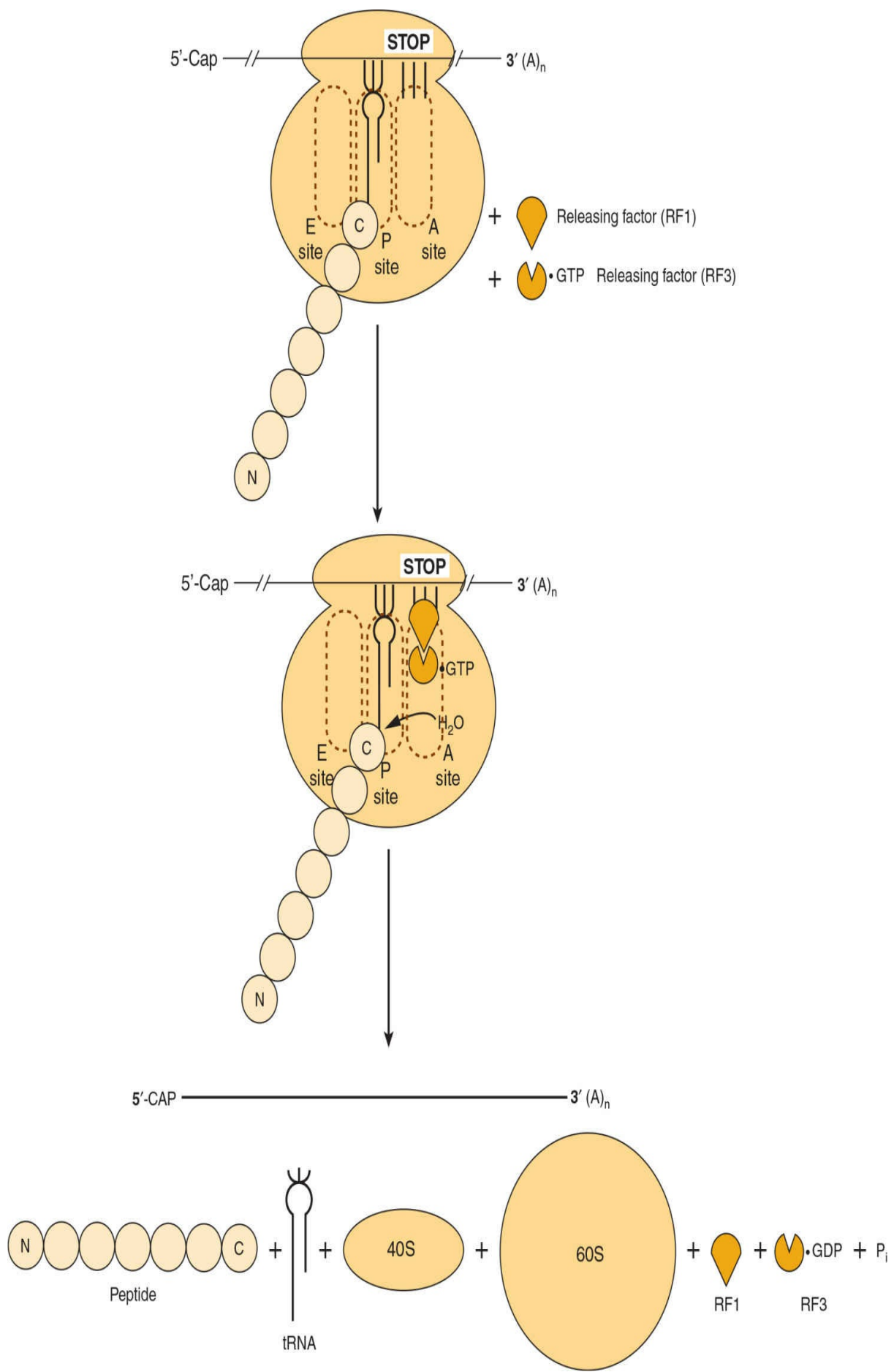

FIGURE 37–10 Diagrammatic representation of the termination process of protein synthesis. The 60S ribosomal peptidyl-tRNA, aminoacyl-tRNA, and exit sites are indicated as P site, A site, and E site, respectively. The termination (stop) codon is indicated by the three vertical bars and STOP. Releasing factor RF1 binds to the stop codon in the A site. Releasing factor RF3, which bound GTP, binds to RF1. Hydrolysis of the peptidyl-tRNA complex is shown by the entry of water (H₂O); arrow. N and C indicate the amino- and carboxy-terminal amino acids of the nascent polypeptide chain, respectively, and illustrate the polarity of protein synthesis. Termination results in release of the mRNA, the newly synthesized protein (N- and C-termini; N, C), free tRNA, 40S and 60S subunits, as well as RF1, GDP-bound RF3, and inorganic P_i, as shown at bottom.

Polysomes Are Assemblies of Ribosomes

Many ribosomes can translate the same mRNA molecule simultaneously. Because of their relatively large size, the ribosome particles cannot attach to an mRNA any closer than 35 nucleotides apart. Multiple ribosomes on the same mRNA molecule form a **polyribosome**, or “**polysome**” (Figure 37–7). In an unrestricted system, the number of ribosomes attached to an mRNA (and thus the size of polyribosomes) correlates positively with the length of the mRNA molecule.

Polyribosomes actively synthesizing proteins can exist as free particles in the cellular cytoplasm or may be attached to sheets of membranous cytoplasmic structures referred to as **ER**. Attachment of the particulate polyribosomes to the ER is responsible for its “rough” appearance as seen by electron microscopy. The proteins synthesized by the attached polyribosomes are extruded into the cisternal space between the sheets of rough ER and are exported from there. Some of the protein products of the rough ER are packaged by the Golgi apparatus for eventual export (see Figures 49–2, 49–6). The polyribosomal particles free in the cytosol are responsible for the synthesis of proteins required for intracellular functions.

Nontranslating mRNAs Can Form Ribonucleoprotein Particles That Accumulate in Cytoplasmic Organelles Termed P Bodies

mRNAs, bound by specific packaging proteins and exported from the nucleus as **ribonucleoproteins particles (mRNPs)** sometimes do not immediately associate with ribosomes to be translated. Instead, specific mRNAs can associate with the protein constituents that form **P bodies**, small dense compartments that incorporate mRNAs as mRNPs (**Figure 37–11**). These cytoplasmic organelles are related to similar small mRNA-containing granules found in neurons and certain maternal cells. P bodies are sites of mRNA metabolism. Over 35 distinct proteins have been suggested to reside exclusively or extensively within P bodies. These proteins range from mRNA decapping enzymes, RNA helicases, and RNA exonucleases (5'-3' and 3'-5'), to components involved in miRNA function and mRNA quality control. However, incorporation of an mRNP is not an unequivocal mRNA “death sentence.” Indeed, though the mechanisms are not yet fully understood, certain mRNAs appear to be temporarily stored in P bodies and then retrieved and utilized for protein translation. This suggests that an equilibrium exists where the cytoplasmic functions of mRNA (translation and degradation) are controlled by the dynamic interaction of mRNA with polysomes and P bodies.

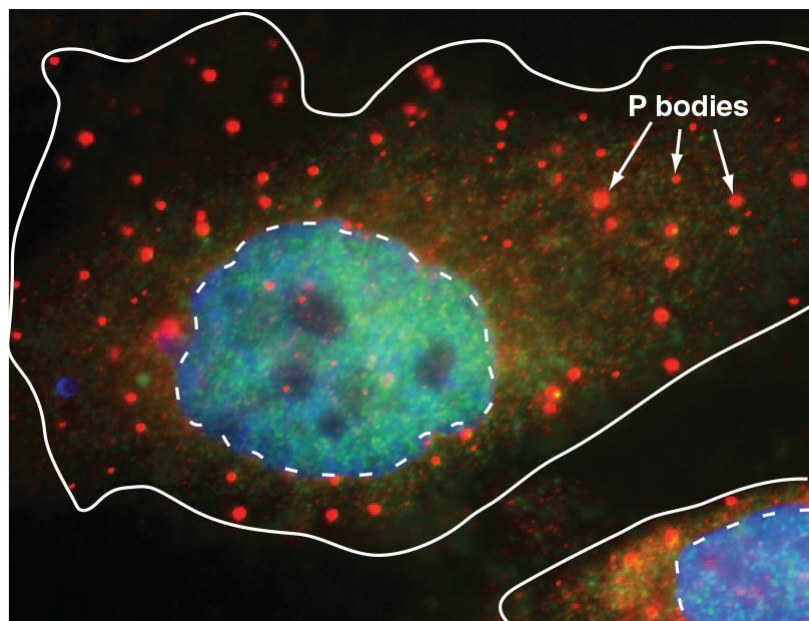

FIGURE 37–11 The P body is a cytoplasmic organelle involved in mRNA metabolism. Shown is a photomicrograph of two mammalian cells in which a single distinct protein constituent of the P body has been visualized using the cognate-specific fluorescently labeled antibody. P bodies appear as small red circles of varying size throughout the cytoplasm. The cell plasma membranes are indicated by a solid white line, nuclei by a dashed line. Nuclei were counterstained using a fluorescent dye

with different fluorescence excitation/emission spectra from the labeled antibody used to identify P bodies; the nuclear stain intercalates between the DNA base pairs and appears as blue/green. Modified from <http://www.mcb.arizona.edu/parker/WHAT/what.htm>. (Used with permission of Dr Roy Parker.)

The Machinery of Protein Synthesis Can Respond to Environmental Threats

Ferritin, an iron-binding protein, prevents ionized iron (Fe^{2+}) from reaching toxic levels within cells. Elemental iron stimulates ferritin synthesis by causing the release of a cytoplasmic protein that binds to a specific region in the 5' nontranslated region of ferritin mRNA. Disruption of this protein-mRNA interaction activates ferritin mRNA and results in its translation. This mechanism provides for rapid control of the synthesis of a protein that sequesters Fe^{2+} , a potentially toxic molecule (see [Figures 52–7, 52–8](#)). Similarly, environmental stress and starvation inhibit the positive roles of mTOR ([Figure 37–8](#); [Figure 42–8](#)) on promoting activation of eIF-4F and 48S complex formation.

Many Viruses Co-opt the Host Cell Protein Synthesis Machinery

The protein synthesis machinery can also be modified in deleterious ways. Viruses replicate by using host cell processes, including those involved in protein synthesis. Some viral mRNAs are translated much more efficiently than those of the host cell (eg, encephalomyocarditis virus). Others, such as reovirus and vesicular stomatitis virus, replicate efficiently, and thus their very abundant mRNAs have a competitive advantage over host cell mRNAs for limited translation factors. Other viruses inhibit host cell protein synthesis by preventing the association of mRNA with the 40S ribosome.

Poliovirus and other picornaviruses gain a selective advantage by disrupting the function of the 4F complex. The mRNAs of these viruses do not have a cap structure to direct the binding of the 40S ribosomal subunit (see above). Instead, the 40S ribosomal subunit contacts an **internal ribosomal entry site (IRES)** in a reaction that requires 4G but not 4E. The virus gains a selective advantage by having a protease that attacks 4G and removes the amino terminal 4E binding site. Now the 4E-4G complex (4F)

cannot form, so the 40S ribosomal subunit cannot be directed to host capped mRNAs, abolishing host cell protein synthesis. The 4G fragment can direct binding of the 40S ribosomal subunit to IRES-containing mRNAs, so viral mRNA translation is very efficient (**Figure 37–12**). These viruses also promote the dephosphorylation of BP1 (PHAS-1), thereby decreasing cap (4E)-dependent translation (**Figure 37–8**).

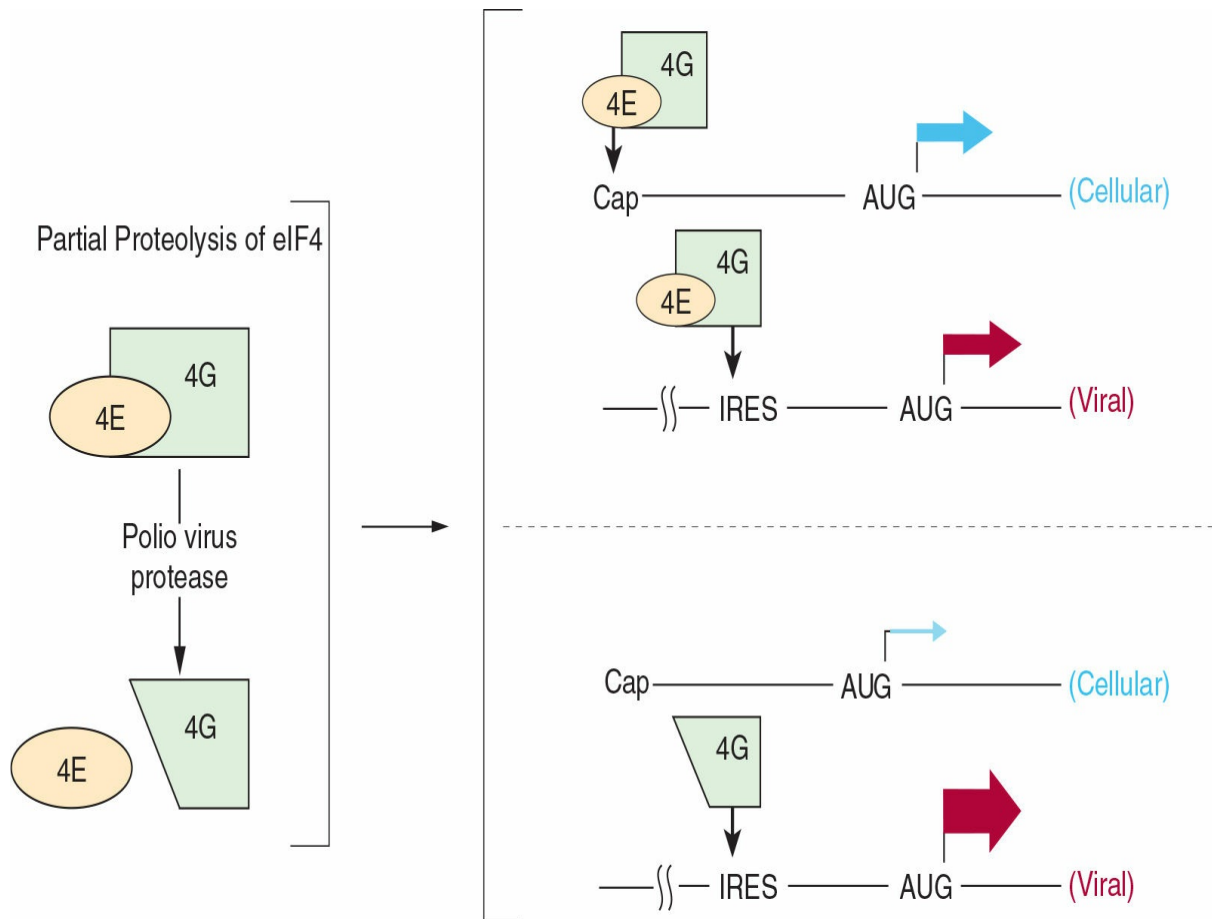

FIGURE 37–12 Picornaviruses disrupt the 4F complex. The 4E-4G complex (4F) directs the 40S ribosomal subunit to the typical capped mRNA (see text). However, 4G alone is sufficient for targeting the 40S subunit to the internal ribosomal entry site (IRES) of certain viral mRNAs. To gain selective advantage, some viruses (eg, poliovirus) express a protease that cleaves the 4E binding site from the amino terminal end of 4G. This truncated 4G can direct the 40S ribosomal subunit to mRNAs that have an IRES but not to those that have a cap (ie, host cell mRNAs). The widths of the arrows indicate the rate of translation initiation from the AUG codon in each example. Other viruses utilize distinct processes to effect selective initiation of translation on their cognate viral mRNAs via IRES elements.

POSTTRANSLATIONAL PROCESSING AFFECTS THE ACTIVITY OF MANY PROTEINS

Some animal viruses, notably HIV, poliovirus, and hepatitis virus, synthesize long polycistronic proteins from one long mRNA molecule. The viral protein molecules translated from these long mRNAs are subsequently cleaved at defined sites to provide the several specific viral proteins required for viral function. In animal cells, many cellular proteins are synthesized from the mRNA template as a precursor molecule, which then must be modified to achieve the active protein. The prototype is insulin, a small protein having two polypeptide chains with interchain and intrachain disulfide bridges. The molecule is synthesized as a single chain precursor, or **prohormone**, which folds to allow specific disulfide bridges to form. A specific protease then clips out the segment that connects the two chains which form the functional insulin molecule (see [Figure 41–12](#)).

Many other peptides are synthesized as precursor proproteins that require modifications before attaining biologic activity. Many of the posttranslational modifications involve the removal of amino terminal amino acid residues by specific aminopeptidases (see [Figure 41–14](#)). By contrast, collagen, an abundant protein in the extracellular spaces of higher eukaryotes, is synthesized as procollagen. Three procollagen polypeptide molecules, frequently not identical in sequence, align themselves in a particular way that is dependent on the existence of specific amino terminal peptides (see [Figure 5–11](#)). Specific enzymes then carry out hydroxylations and oxidations of specific amino acid residues within the procollagen molecules to provide cross-links for greater stability. Amino terminal peptides are cleaved off the molecule to form the final product—a strong, insoluble collagen molecule. Many other posttranslational modifications of proteins occur. Covalent modification by acetylation, phosphorylation, methylation, ubiquitylation, and glycosylation is common, for example (see [Chapter 5](#); [Table 35–1](#)).

MANY ANTIBIOTICS WORK BY SELECTIVELY INHIBITING PROTEIN SYNTHESIS IN BACTERIA

Ribosomes in bacteria and in the mitochondria of higher eukaryotic cells differ from the mammalian ribosome described in [Chapter 34](#). The bacterial ribosome is smaller (70S vs 80S) and has a different, somewhat simpler complement of RNA and protein molecules. This difference can

be exploited for clinical purposes because many effective antibiotics interact specifically with the proteins and RNAs of prokaryotic ribosomes and thus only inhibit bacterial protein synthesis. This results in growth arrest or death of the bacterium. The most useful members of this class of **antibiotics** (eg, **tetracyclines**, **lincomycin**, **erythromycin**, and **chloramphenicol**) do not interact with components of eukaryotic ribosomes and thus are not toxic to eukaryotes. Tetracycline prevents the binding of aminoacyl-tRNAs to the bacterial ribosome A site. Chloramphenicol works by binding to 23S rRNA, which is interesting in view of the newly appreciated role of rRNA in peptide bond formation through its peptidyl transferase activity. It should be mentioned that the close similarity between prokaryotic and mitochondrial ribosomes can lead to complications in the use of some antibiotics.

Other antibiotics inhibit protein synthesis on all ribosomes (**puromycin**) or only on those of eukaryotic cells (**cycloheximide**). Puromycin (**Figure 37–13**) is a structural analog of tyrosinyl-tRNA. Puromycin is incorporated via the A site on the ribosome into the carboxyl terminal position of a peptide but causes the premature release of the polypeptide. Puromycin, as a tyrosinyl-tRNA analog, effectively inhibits protein synthesis in both prokaryotes and eukaryotes. Cycloheximide inhibits peptidyl transferase in the 60S ribosomal subunit in eukaryotes, presumably by binding to an rRNA component.

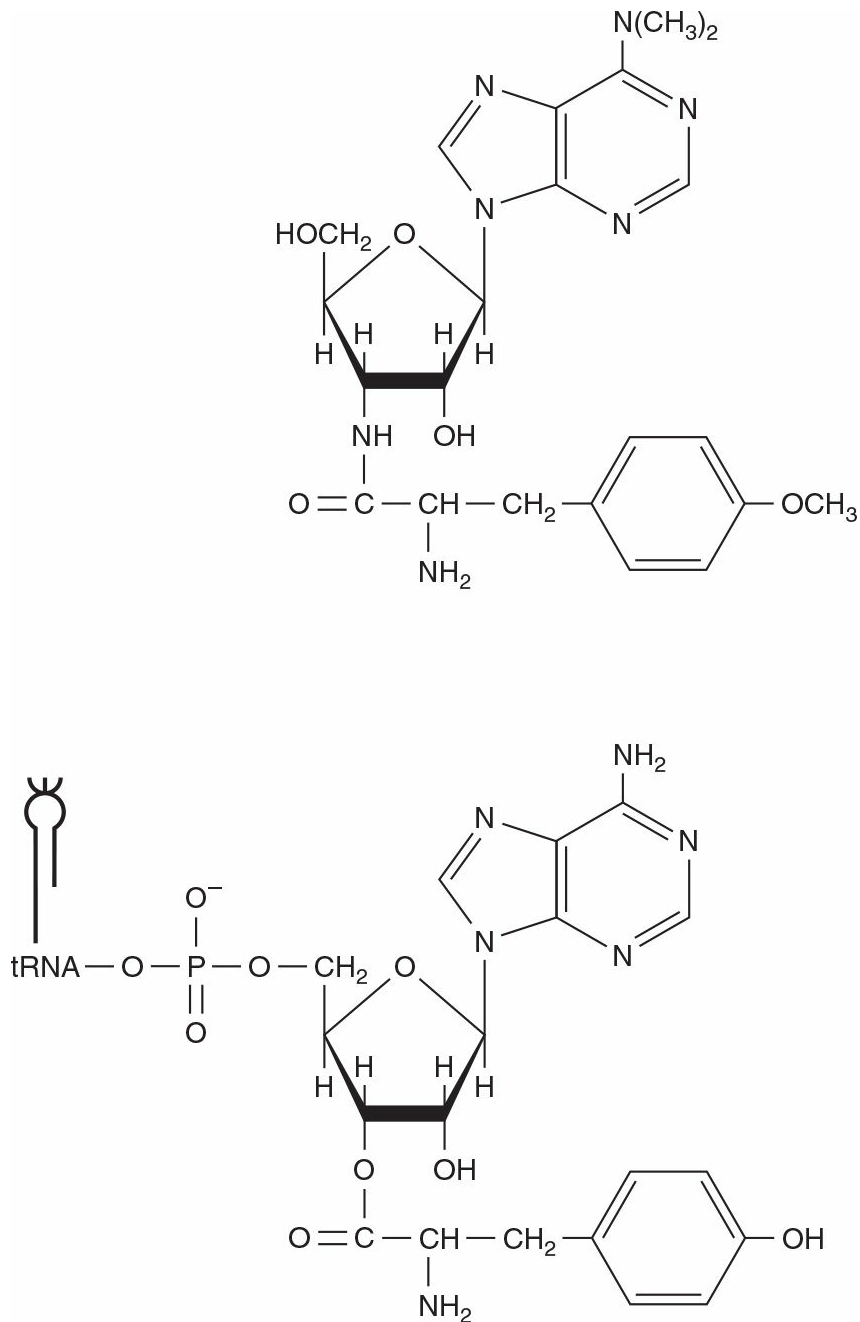

FIGURE 37–13 The comparative structures of the antibiotic puromycin (top) and the 3' terminal portion of tyrosyl-tRNA (bottom).

Diphtheria toxin, an exotoxin of *Corynebacterium diphtheriae* infected with a specific lysogenic phage, catalyzes the ADP-ribosylation of EF-2 on the unique amino acid diphthamide (a posttranslationally modified version of histidine) in mammalian cells. This modification inactivates EF-2 and thereby specifically inhibits mammalian protein synthesis. Many animals (eg, mice) are resistant to diphtheria toxin. This resistance is due to inability of diphtheria toxin to cross the cell membrane

rather than to insensitivity of mouse EF-2 to diphtheria toxin-catalyzed ADP-ribosylation by NAD.

Ricin, an extremely toxic molecule isolated from the castor bean, inactivates eukaryotic 28S ribosomal RNA by catalyzing the N-glycolytic cleavage or removal of a single adenine.

Many of these compounds—puromycin and cycloheximide in particular—are not clinically useful but have been important in elucidating the role of protein synthesis in the regulation of metabolic processes, particularly enzyme induction by hormones.

SUMMARY

- The flow of genetic information generally follows the sequence DNA → RNA → protein.
- Ribosomal RNA (rRNA), transfer RNA (tRNA), and messenger RNA (mRNA) are directly involved in protein synthesis.
- The information in mRNA is a continuous array of codons, each of which is three nucleotides long.
- The mRNA is read continuously from a start (AUG) to termination (UAA, UAG, UGA) codon.
- The open reading frame, or ORF, of the mRNA is the series of contiguous codons (AUG to STOP), each specifying a certain amino acid, that determines the precise amino acid sequence of the protein.
- Protein synthesis, like DNA and RNA synthesis, follows the 5' to 3' polarity of mRNA and can be divided into three processes: initiation, elongation, and termination.
- Mutant proteins arise when single-base substitutions result in codons that specify a different amino acid at a given position, when a stop codon results in a truncated protein, or when base additions or deletions alter the reading frame, so different codons are read.
- A variety of compounds, including several antibiotics, inhibit protein synthesis by affecting one or more of the steps involved in protein synthesis.

REFERENCES

- Crick FH, Barnett L, Brenner S, et al: General nature of the genetic code for proteins. *Nature* 1961;192:1227-1232.
- Frank, J: Whither ribosome structure and dynamics? (A perspective). *J Mol Biology* 2016;428:3565-3569.

- Hinnebusch AG: The scanning mechanism of eukaryotic translation initiation. *Ann Rev Biochem* 2014;83:779-812.
- Hinnebusch AG, Ivanov IP, Sonenberg N: Translational control by 5'-untranslated regions of eukaryotic mRNAs. *Science* 2016;352:1413-1416.
- Jain S, Parker R: The discovery and analysis of P bodies. *Adv Exp Med Biol* 2013;768:23-43.
- Kozak M: Structural features in eukaryotic mRNAs that modulate the initiation of translation. *J Biol Chem* 1991;266:1986-1970.
- Liu CC, Schultz PG: Adding new chemistries to the genetic code. *Annu Rev Biochem* 2010;79:413-444.
- Moore PB, Steitz TA: The roles of RNA in the synthesis of protein. *Cold Spring Harb Perspect Biol* 2011;3:a003780.
- Sonenberg N, Hinnebusch AG: Regulation of translation initiation in eukaryotes: mechanisms and biological targets. *Cell* 2009;136:731-745.
- Thompson SR: Tricks an IRES uses to enslave ribosomes. *Trends Microbiol* 2012;20:558-566.
- Wang Q, Parrish AR, Wang L: Expanding the genetic code for biological studies. *Chem Biol* 2009;16:323-336.
- Weatherall DJ: Thalassaemia: the long road from bedside to genome. *Nat Rev Genet* 2004;5:625-631.
- Wilson DN: Ribosome-targeting antibiotics and mechanisms of bacterial resistance. *Nat Rev Microbiol* 2013;12:35-48.

Regulation of Gene Expression

P. Anthony Weil, PhD

OBJECTIVES

After studying this chapter, you should be able to:

- Explain that the many steps involved in the vectorial processes of gene expression, which range from targeted modulation of gene copy number, to gene rearrangement, to transcription, to mRNA processing and transport from the nucleus, to translation, to protein subcellular compartmentalization, to posttranslational modification and degradation, are all subject to regulatory control, both positive and negative. Changes in any, or multiple of these processes, can increase or decrease the amount and/or activity of the cognate gene product.
- Appreciate that DNA-binding transcription factors, proteins that bind to specific DNA sequences that are physically linked to their target transcriptional promoter elements, can either activate or repress gene transcription.
- Recognize that DNA-binding transcription factors are often modular proteins that are composed of structurally and functionally distinct domains, which can directly or indirectly control messenger RNA (mRNA) gene transcription, either

through contacts with RNA polymerase and its cofactors, or through interactions with coregulators that modulate nucleosome structure, composition, and position via histone covalent modifications and/or nucleosome displacement.

- Understand that nucleosome-directed regulatory events typically increase or decrease the accessibility of the underlying DNA such as enhancer or promoter sequences, although nucleosome modification can also create new binding sites for other coregulators.
- Describe how the processes of gene transcription, RNA processing, and nuclear export of RNA are all coupled.

BIOMEDICAL IMPORTANCE

Organisms alter expression of genes in response to genetic developmental cues or programs, environmental challenges, or disease, by modulating the amount, the spatial, and/or the temporal patterns of gene expression. The mechanisms controlling gene expression have been studied in detail and often involve modulation of gene transcription. Control of transcription ultimately results from changes in the mode of interaction of specific regulatory molecules, usually proteins, with various regions of DNA in the regulated gene. Such interactions can either have a positive or negative effect on transcription. Transcription control can result in tissue-specific gene expression, and gene regulation can be influenced by a range of physiologic, biologic, environmental, and pharmacologic agents.

In addition to transcription level controls, gene expression can also be modulated by gene amplification, gene rearrangement, posttranscriptional modifications, RNA stabilization, translational control, protein modification, protein compartmentalization, and protein stabilization or degradation. Many of the mechanisms that control gene expression are used to respond to developmental cues, growth factors, hormones, environmental agents, and therapeutic drugs. Dysregulation of gene expression can lead to human disease. Thus, a molecular understanding of these processes will lead to development of therapeutics that can alter pathophysiologic mechanisms or inhibit the function or arrest the growth of pathogenic organisms.

REGULATED EXPRESSION OF GENES IS

REQUIRED FOR DEVELOPMENT, DIFFERENTIATION, & ADAPTATION

The genetic information present in each normal somatic cell of a metazoan organism is practically identical. The genetically reproducible, hardwired exceptions are found in those few cells that have amplified or rearranged genes in order to perform specialized cellular functions. Of course, in various disease states chromosome integrity is altered (ie, cancer; [Figure 56–11](#)) sometimes even at the whole chromosome level (eg, trisomy 21, that causes Down syndrome). Expression of the genetic information must be regulated during ontogeny and differentiation of the organism and its cellular components. Furthermore, in order for the organism to adapt to its environment and to conserve energy and nutrients, the expression of genetic information must be cued to extrinsic signals and respond only when necessary. As organisms have evolved, more sophisticated regulatory mechanisms have appeared which provide the organism and its cells with the responsiveness necessary for survival in a complex environment. Mammalian cells possess about 1000 times more genetic information than does the bacterium *Escherichia coli*. Much of this additional genetic information is likely involved in regulation of gene expression during the differentiation of tissues and biologic processes in the multicellular organism and in ensuring that the organism can respond to complex environmental challenges.

In simple terms, there are only two types of gene regulation: **positive regulation** and **negative regulation** ([Table 38–1](#)). When the expression of genetic information is quantitatively increased by the presence of a specific regulatory element, regulation is said to be positive; when the expression of genetic information is diminished by the presence of a specific regulatory element, regulation is said to be negative. The element or molecule mediating negative regulation is said to be a **negative regulator**, a **silencer** or **repressor**; the element that mediating positive regulation is a **positive regulator**, an **enhancer** or **activator**. However, a **double negative** has the effect of acting as a positive. Thus, an effector that inhibits the function of a negative regulator will appear to bring about a positive regulation. Many regulated systems that appear to be induced are in fact **derepressed** at the molecular level. (See [Chapter 9](#) for additional discussion of these terms.)

TABLE 38–1 Effects of Positive and Negative Regulation on Gene Expression

	Rate of Gene Expression	
	Negative Regulation	Positive Regulation
Regulator present	Decreased	Increased
Regulator absent	Increased	Decreased

BIOLOGIC SYSTEMS EXHIBIT THREE TYPES OF TEMPORAL RESPONSES TO A REGULATORY SIGNAL

Figure 38–1 depicts the extent or amount of gene expression in three types of temporal responses to an inducing signal. A **type A response** is characterized by an increased extent of gene expression that is dependent on the continued presence of the inducing signal. When the inducing signal is removed, the amount of gene expression diminishes to its basal level, but the amount repeatedly increases in response to the reappearance of the specific signal. This type of response is commonly observed in prokaryotes in response to sudden changes of the intracellular concentration of a nutrient. It is also observed in many higher organisms after exposure to inducers such as hormones, nutrients, or growth factors (see [Chapter 42](#)).

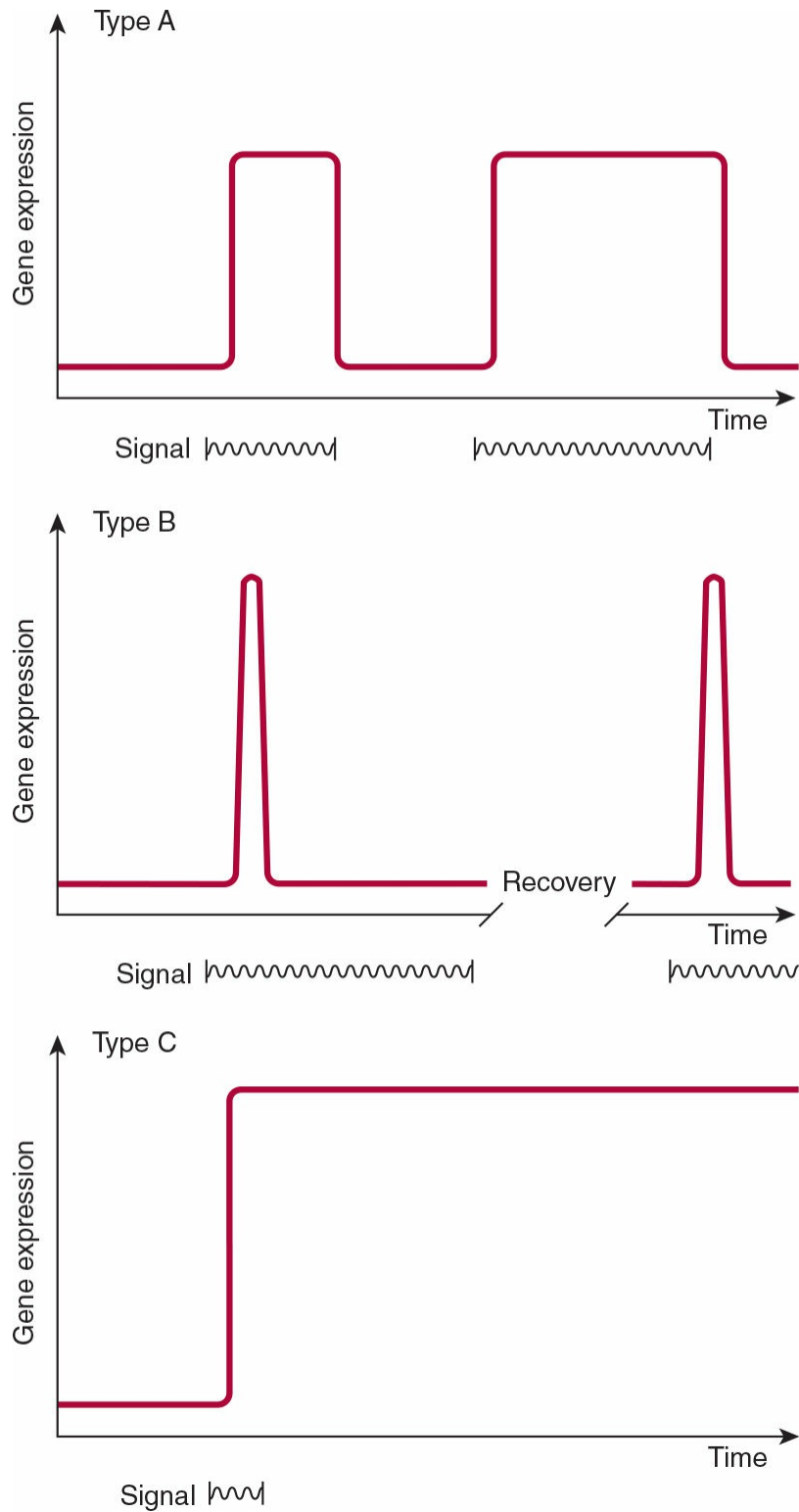

FIGURE 38–1 Diagrammatic representations of the responses of the extent of expression of a gene to specific regulatory signals as a function of time.

A **type B response** exhibits an increased amount of gene expression that is transient even in the continued presence of the regulatory signal.

After the regulatory signal has terminated and the cell has been allowed to recover, a second transient response to a subsequent regulatory signal may be observed. This phenomenon of response-desensitization recovery characterizes the action of many pharmacologic agents, but it is also a feature of many naturally occurring processes. This type of response commonly occurs during development of an organism, when only the transient appearance of a specific gene product is required although the signal persists.

The **type C response** pattern exhibits, in response to the regulatory signal, an increased extent of gene expression that persists indefinitely even after termination of the signal. The signal acts as a trigger in this pattern. Once expression of the gene is initiated in the cell, it cannot be terminated even in the daughter cells; it is therefore an irreversible and inherited alteration. This type of response typically occurs during the development of differentiated function in a tissue or organ.

Simple Unicellular and Multicellular Organisms Serve as Valuable Models for the Study of Gene Expression in Mammalian Cells

Analysis of the regulation of gene expression in prokaryotic cells helped establish the principle that information flows from the gene to a messenger RNA to a specific protein molecule. These studies were aided by the advanced genetic analyses that could be performed in prokaryotic and lower eukaryotic organisms such as baker's yeast, *Saccharomyces cerevisiae*, and the fruit fly, *Drosophila melanogaster*, among others. In recent years, the principles established in these studies, coupled with a variety of molecular biology techniques, have led to remarkable progress in the analysis of gene regulation in higher eukaryotic organisms, including mammals. In this chapter, the initial discussion will center on prokaryotic systems. The impressive genetic studies will not be described, but the physiology of gene expression will be discussed. However, nearly all of the conclusions about this physiology have been derived from genetic studies and confirmed by molecular genetic and biochemical experiments.

Some Features of Prokaryotic Gene Expression Are Unique

Before the physiology of gene expression can be explained, a few specialized genetic and regulatory terms must be defined for prokaryotic systems. In prokaryotes, the genes involved in a metabolic pathway are often present in a linear array called an **operon**, for example, the *lac* operon. An operon can be regulated by a single promoter or regulatory region. The **cistron** is the smallest unit of genetic expression. A single mRNA that encodes more than one separately translated protein is referred to as a **polycistronic mRNA**. For example, the polycistronic *lac* operon mRNA is translated into three separate proteins (see below). Operons and polycistronic mRNAs are common in bacteria but not in eukaryotes.

An **inducible gene** is one whose expression increases in response to an **inducer** or **activator**, a specific positive regulatory signal. In general, inducible genes have relatively low basal rates of transcription. By contrast, genes with high basal rates of transcription are often subject to downregulation by repressors.

The expression of some genes is **constitutive**, meaning that they are expressed at a reasonably constant rate and not known to be subject to regulation. These are often referred to as **housekeeping genes**. As a result of mutation, some inducible gene products become constitutively expressed. A mutation resulting in constitutive expression of what was formerly a regulated gene is called a **constitutive mutation**.

Analysis of Lactose Metabolism in *E. coli* Led to the Discovery of the Basic Principles of Gene Transcription Activation and Repression

Jacob and Monod in 1961 described their **operon model** in a classic paper. Their hypothesis was to a large extent based on observations on the regulation of lactose metabolism by the intestinal bacterium *E. coli*. The molecular mechanisms responsible for the regulation of the genes involved in the metabolism of lactose are now among the best-understood in any organism. β -Galactosidase hydrolyzes the β -galactoside lactose to galactose and glucose. The gene encoding β -galactosidase (*lacZ*) is clustered with the genes encoding lactose permease (*lacY*) and thiogalactoside transacetylase (*lacA*). The genes encoding these three enzymes, along with the *lac* promoter and *lac* operator (a regulatory region), and the *lacI* gene encoding the LacI repressor are physically linked and constitute the ***lac* operon** as depicted in **Figure 38–2**. This genetic arrangement of the *lac* operon allows for **coordinate expression** of

the three enzymes concerned with lactose metabolism. Each of the linked operon genes is transcribed into one large polycistronic mRNA molecule that contains multiple independent translation start (AUG) and stop (UAA) codons for each of the three cistrons. Thus, each protein is translated separately, and they are not processed from a single large precursor protein.

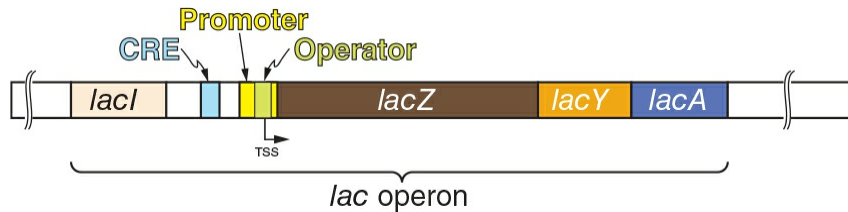

FIGURE 38–2 The positional relationships of the protein coding and regulatory elements of the ~6kbp *lac* operon. *lacZ* encodes β -galactosidase, *lacY* encodes a permease, and *lacA* encodes a thiogalactoside transacetylase. *lacI* encodes the *lac* operon repressor protein. Also shown is the transcription start site for *lac* operon transcription (TSS). Note that the binding site for the LacI protein (ie, lac repressor)—the *lac* operator (Operator) overlaps the *lac* promoter. Immediately upstream of the *lac* operon promoter is the binding site (CRE) for the cAMP-binding protein, CAP, the positive regulator of *lac* operon transcription. See [Figure 38–3](#) for more detail.

It is now conventional to consider that a gene includes regulatory sequences as well as the region that encodes the primary transcript. Although there are many historical exceptions, a gene is generally italicized in lower case and the encoded protein, when abbreviated, is expressed in roman type with the first letter capitalized. For example, the gene *lacI* encodes the repressor protein LacI. When *E. coli* is presented with lactose or some specific lactose analogs under appropriate nonrepressing conditions (eg, high concentrations of lactose, no or very low glucose in media; see below), the expression of the activities of β -galactosidase, galactoside permease, and thiogalactoside transacetylase is increased 100-fold to 1000-fold. This is a type A response, as depicted in [Figure 38–1](#). The kinetics of induction can be quite rapid; *lac*-specific mRNAs are fully induced within ~5 minutes after addition of lactose to a culture; β -galactosidase protein is maximal within 10 minutes. Under fully induced conditions, there can be up to 5000 β -galactosidase molecules per cell, an amount about 1000 times greater than the basal, uninduced level. Upon removal of the signal, that is, the inducer, the synthesis of these three

enzymes declines.

When *E. coli* is exposed to both lactose and glucose as sources of carbon, the cells first metabolize the glucose and then temporarily stop growing until the genes of the *lac* operon become induced to provide the ability to metabolize lactose as a usable energy source. Although lactose is present from the beginning of the bacterial growth phase, the cell does not induce those enzymes necessary for catabolism of lactose until glucose has been exhausted. This phenomenon was first thought to be attributable to repression of the *lac* operon by some catabolite of glucose; hence, it was termed catabolite repression. It is now known that catabolite repression is in fact mediated by a **catabolite activator protein (CAP)** in conjunction with **3',5' cyclic Adenosine monophosphate (cAMP)**; see [Figure 18–5](#)). This protein is also referred to as the cAMP regulatory protein (CRP). The expression of many inducible enzyme systems or operons in *E. coli* and other prokaryotes is sensitive to catabolite repression, as discussed below.

The physiology of induction of the *lac* operon is well understood at the molecular level ([Figure 38–3](#)). Expression of the normal *lacI* gene of the *lac* operon is constitutive; it is expressed at a constant rate, resulting in formation of the subunits of the **lac repressor**. Four identical subunits with molecular weights of 38,000 assemble into a tetrameric Lac repressor molecule. The LacI repressor protein molecule, the product of *lacI*, has a very high affinity (dissociation constant, K_d about 10^{-13} mol/L) for the operator locus. The **operator locus** is a region of double-stranded DNA that exhibits a twofold rotational symmetry and an inverted palindrome (indicated by arrows about the dotted axis) in a region that is 21-bp long, as shown below:

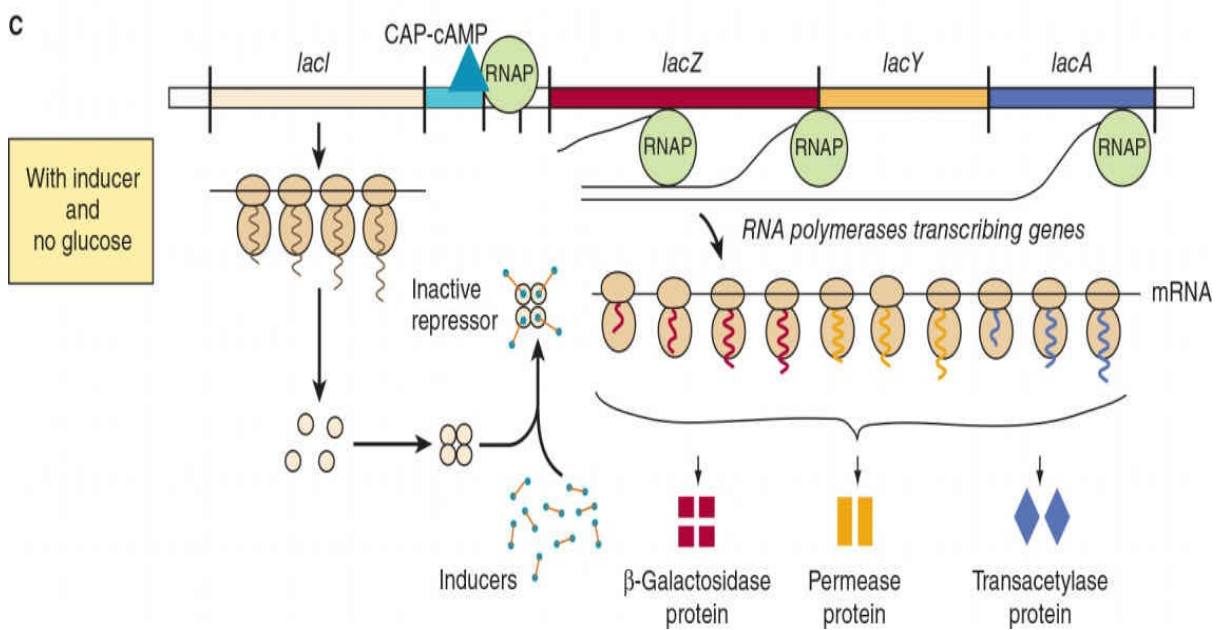
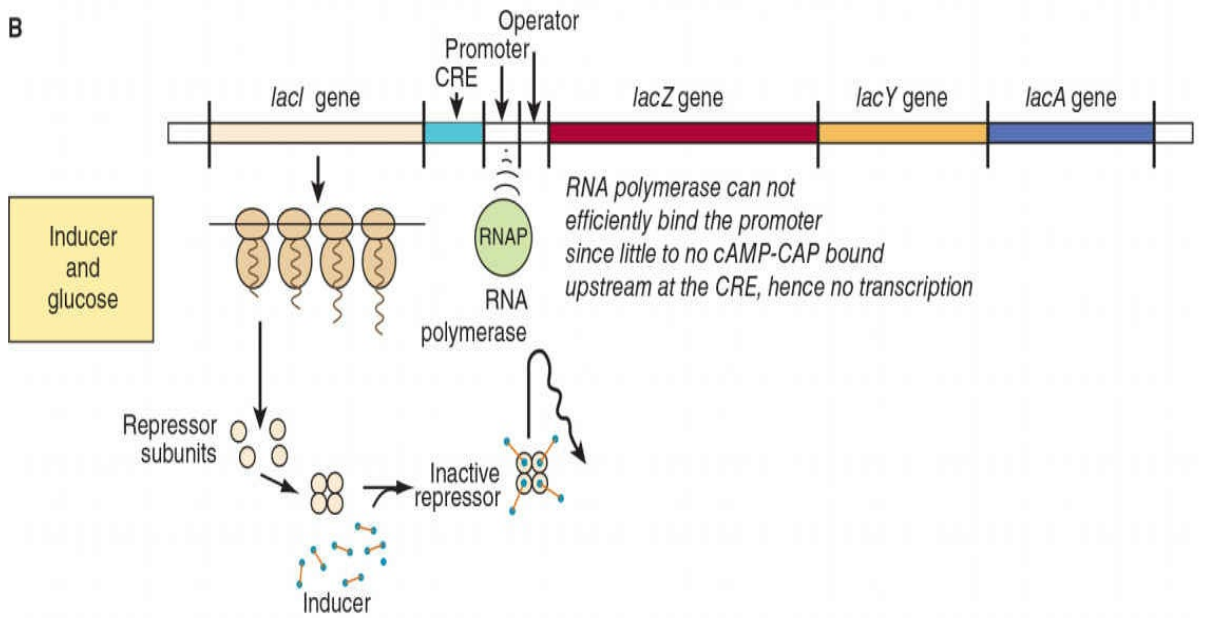
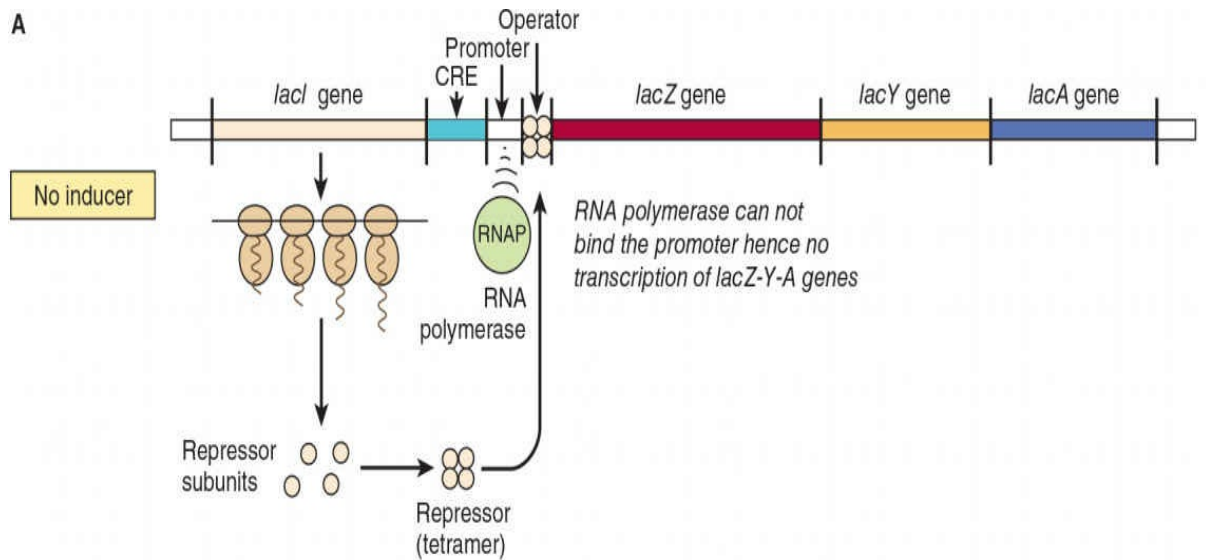

FIGURE 38–3 The mechanism of repression, derepression, and activation of the *lac* operon. When no inducer is present (**A**), the constitutively synthesized *lacI* gene products form a repressor tetramer that binds to the operator. Repressor-operator binding prevents the binding of RNA polymerase and consequently prevents transcription of the *lacZ*, *lacY*, and *lacA* structural genes into a polycistronic mRNA. When inducer is present, but glucose is also present in the culture medium (**B**), the tetrameric repressor molecules are conformationally altered by inducer, and cannot efficiently bind to the operator locus (affinity of binding reduced >1000-fold). However, RNA polymerase will not efficiently bind the promoter and initiate transcription because positive protein–protein interactions between CRE-bound CAP protein fail to occur; thus, the *lac* operon is not efficiently transcribed. However, when inducer is present, and glucose is depleted from the medium (**C**), adenylyl cyclase is activated and cAMP is produced. This cAMP binds with high affinity to its binding protein the cyclic AMP activator protein, or CAP. The CAP-cAMP complex binds to its recognition sequence (CRE, the cAMP response element) at *lac* operon nucleotide coordinate –50. Direct protein–protein contacts between the CRE-bound CAP and the RNA polymerase increases promoter binding >20-fold; hence RNAP will efficiently transcribe the *lac* operon and the polycistronic *lacZ-lacY-lacA* mRNA molecule formed can be translated into the corresponding protein molecules β -galactosidase, permease, and transacetylase as shown. This protein production enables cellular catabolism of lactose as the sole carbon source for growth.



At any one time, only two of the four subunits of the repressor appear to bind to the operator, and within the 21-base-pair region nearly every base of each base pair is involved in LacI recognition and binding. The binding occurs mostly in the **major groove** without interrupting the base-paired, double-helical nature of the operator DNA. The **operator locus** is between the **promoter site**, at which the DNA-dependent RNA polymerase attaches to commence transcription, and the transcription initiation site of the ***lacZ* gene**, the structural gene for β -galactosidase (Figure 38–2). When bound to the operator locus, the LacI repressor molecule prevents transcription of the distal structural genes, *lacZ*, *lacY*,

and *lacA* by interfering with the binding of RNA polymerase to the promoter; RNA polymerase and LacI repressor cannot be effectively bound to the *lac* operon at the same time. Thus, the LacI repressor molecule is a **negative regulator**, and in its presence (and in the absence of inducer; see below), expression from the *lacZ*, *lacY*, and *lacA* genes is very, very low. There are normally about 30 repressor tetramer molecules in the cell, a concentration (3×10^{-8} mol/L) of tetramer sufficient to effect, at any given time, >95% occupancy of the one *lac* operator element in a bacterium, thus ensuring low (but not zero) basal *lac* operon gene transcription in the absence of inducing signals.

A lactose analog that is capable of inducing the *lac* operon while not itself serving as a substrate for β -galactosidase is an example of a **gratuitous inducer**. An example is **isopropylthiogalactoside (IPTG)**. The addition of lactose or of a gratuitous inducer such as IPTG to bacteria growing on a poorly utilized carbon source (such as succinate) results in prompt induction of the *lac* operon enzymes. Small amounts of the gratuitous inducer or of lactose are able to enter the cell even in the absence of permease. The LacI repressor molecules—both those attached to the operator loci and those free in the cytosol—have a high affinity for the inducer. Binding of the inducer to repressor molecule induces a conformational change in the structure of the repressor that causes a decrease in operator DNA occupancy because its affinity for the operator is now 10^4 times lower (K_d about 10^{-9} mol/L) than that of LacI in the absence of IPTG. DNA-dependent RNA polymerase can now bind to the promoter (ie, [Figures 36–3](#) and [36–8](#)), and transcription will begin, although this process is relatively inefficient (see below). In such a manner, **an inducer derepresses the *lac* operon** and allows transcription of the genes encoding β -galactosidase, galactoside permease, and thiogalactoside transacetylase. Translation of the polycistronic mRNA can occur even before transcription is completed. Derepression of the *lac* operon allows the cell to synthesize the enzymes necessary to catabolize lactose as an energy source. Based on the physiology just described, IPTG-induced expression of transfected plasmids bearing the *lac* operator–promoter ligated to appropriate bioengineered constructs is commonly used to express mammalian recombinant proteins in *E. coli*.

In order for the RNA polymerase to form a PIC at the promoter site most efficiently, the cAMP-CAP complex must also be present in the cell. By an independent mechanism, the bacterium accumulates cAMP only when it is starved for a source of carbon. In the presence of glucose—or of

glycerol in concentrations sufficient for growth—the bacteria will lack sufficient cAMP to bind to CAP because glucose inhibits adenylyl cyclase, the enzyme that converts ATP to cAMP (see [Chapter 42](#)). Thus, in the presence of glucose or glycerol, cAMP-saturated CAP is lacking, so that the DNA-dependent RNA polymerase cannot initiate transcription of the *lac* operon at the maximal rate. However, in the presence of the CAP-cAMP complex, which binds to **CAP Response Element (CRE)** DNA just upstream of the promoter site, transcription occurs at maximal levels ([Figure 38–3](#)). Studies indicate that a region of CAP directly contacts the RNA polymerase (RNAP) α subunit, and these protein–protein interactions facilitate the binding of RNAP to the promoter. Thus, the CAP-cAMP regulator is acting as a **positive regulator** because its presence is required for optimal gene expression. The *lac* operon is therefore controlled by two distinct, ligand-modulated DNA-binding *trans*-factors; one that acts positively (cAMP-CRP complex) to facilitate productive binding of RNA polymerase to the promoter and one that acts negatively (LacI repressor) that antagonizes RNA polymerase promoter binding. Maximal activity of the *lac* operon occurs when glucose levels are low (high cAMP with CAP activation) and lactose is present (LacI is prevented from binding to the operator).

When the *lacI* gene has been mutated so that its product, LacI, is not capable of binding to operator DNA, the organism will exhibit **constitutive expression** of the *lac* operon. In a contrary manner, an organism with a *lacI* gene mutation that produces a LacI protein which prevents the binding of lactose or other small molecule inducer to the repressor will remain repressed even in the presence of the inducer molecule, because such ligands cannot bind to the repressor on the operator locus in order to derepress the operon. Similarly, bacteria harboring mutations in their *lac* operator locus such that the operator sequence will not bind a normal repressor molecule will constitutively express the *lac* operon genes. Mechanisms of positive and negative regulation comparable to those described here for the *lac* system have been observed in eukaryotic cells (see below).

The Genetic Switch of Bacteriophage Lambda (λ) Provides Another Paradigm for Understanding the Role of Protein-DNA Interactions in Transcriptional Regulation in Eukaryotic Cells

Like some eukaryotic viruses (eg, herpes simplex virus and HIV), certain bacterial viruses can either reside in a dormant state within the host chromosomes or can replicate within the bacterium and eventually lead to lysis and killing of the bacterial host. Some *E. coli* harbor such a “temperate” virus, bacteriophage lambda (λ). When lambda infects an organism of that species, it injects its 45,000-bp, double-stranded, linear DNA genome into the cell (**Figure 38–4**). Depending on the nutritional state of the cell, the lambda DNA will either **integrate** into the host genome (**lysogenic pathway**) and remain dormant until activated (see below), or it will commence **replicating** until it has made about 100 copies of complete, protein-packaged virus, at which point it causes lysis of its host (**lytic pathway**). The newly generated virus particles can then infect other susceptible host cells. Poor growth conditions favor lysogeny while good growth conditions promote the lytic pathway of lambda growth.

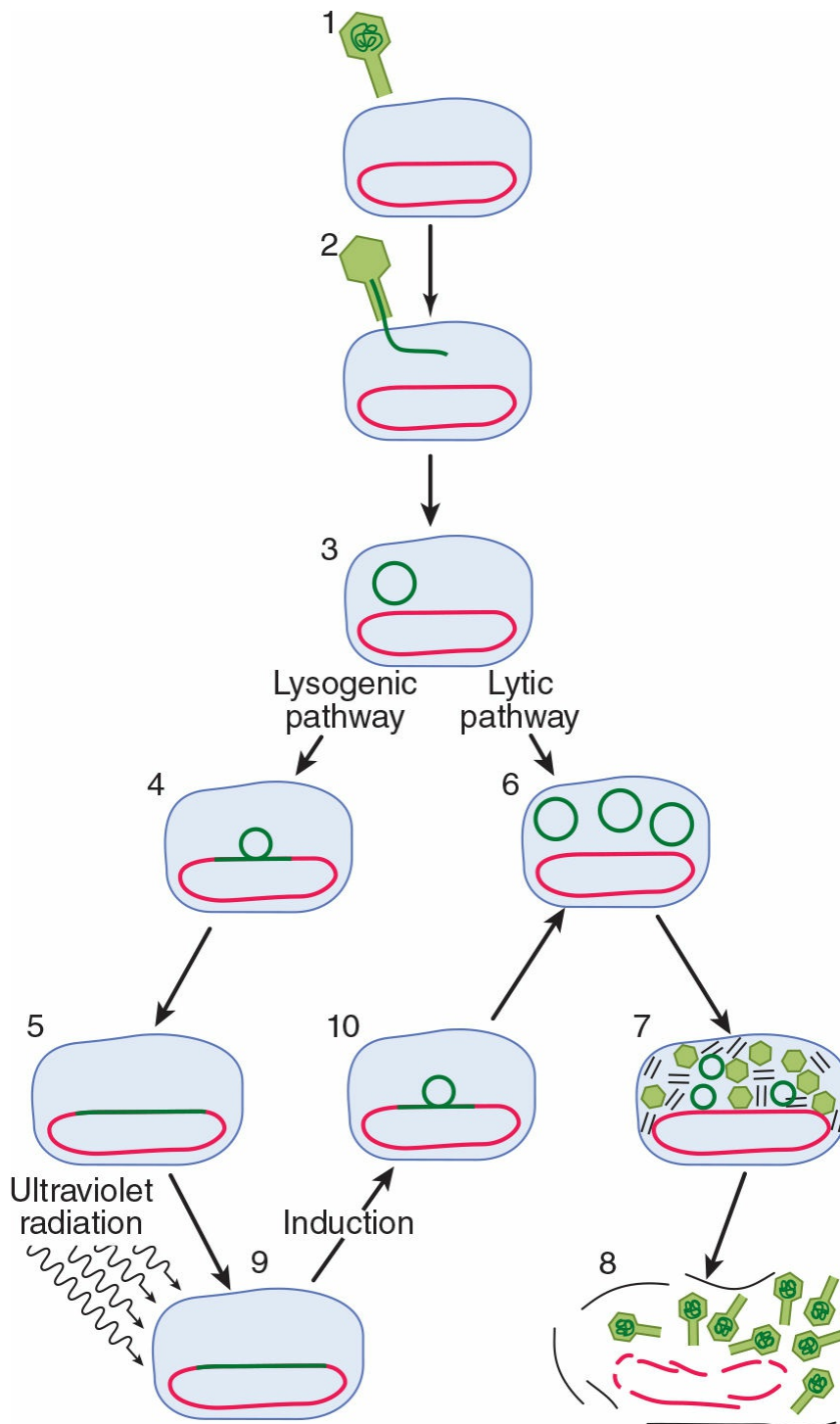

FIGURE 38–4 Alternate lifestyles of bacteriophage lambda. Infection of the bacterium *E. coli* by phage lambda begins when a virus particle attaches itself to specific receptors on the bacterial cell surface (1) and injects its DNA (dark green line) into the cell (2), where the phage genome then circularizes (3). Infection can take either of two courses depending on which of two sets of viral genes is turned on. In the lysogenic pathway, the viral DNA becomes integrated into the bacterial chromosome (red) (4, 5), where it is replicated passively as part of the bacterial DNA during *E. coli*

cell division. This dormant, genomically integrated virus is called a prophage, and the cell that harbors it is called a lysogen. In the alternative, lytic mode of infection, the viral DNA excises from the *E. coli* chromosome and replicates itself (6) in order to direct the synthesis of viral proteins (7). About 100 new virus particles are formed. The proliferating viruses induce lysis of the cell (8). A prophage can be “induced” by a DNA damaging agent such as ultraviolet radiation (9). The inducing agent throws a switch (see text and Figure 38–5; the λ “molecular switch.”), so that a different set of viral genes is turned on. Viral DNA loops out and is excised from the *E. coli* chromosome (10) and replicates; the virus then proceeds along the lytic pathway. (Reproduced, with permission, from Ptashne M, Johnson AD, Pabo CO: A genetic switch in a bacterial virus. *Sci Am* [Nov] 1982;247:128.)

When integrated into the host genome in its dormant state, lambda will remain in that state until activated by exposure of its bacterial host to DNA-damaging agents. In response to such a noxious stimulus, the dormant bacteriophage becomes “induced” and begins to transcribe and subsequently translate those genes of its own genome that are necessary for its excision from the host chromosome, its DNA replication, and the synthesis of its protein coat and lysis enzymes. This event acts like a trigger or type C (Figure 38–1) response; that is, once dormant lambda has committed itself to induction, there is no turning back until the cell is lysed and the replicated bacteriophage released. This switch from a dormant or **prophage state** to a **lytic infection** is well understood at the genetic and molecular levels and will be described in detail here; though less well understood at the molecular level, HIV and herpes viruses can behave similarly, transitioning from dormant to active states in infected humans.

The lytic/lysogenic genetic switching event in lambda is centered around an 80-bp region in its double-stranded DNA genome referred to as the “right operator” (O_R) (Figure 38–5A). The **right operator** is flanked on its left side by the gene for the lambda repressor protein, *cI*, and on its right side by the gene encoding another regulatory protein, the *cro* gene. When lambda is in its prophage state—that is, integrated into the host genome—the *cI* repressor gene is the *only* lambda gene that is expressed. When the bacteriophage is undergoing lytic growth, the *cI* repressor gene is not expressed, but the *cro* gene—as well as many other lambda genes—is expressed. Thus, when the *cI* repressor gene is on, the *cro* gene is off, and when the *cro* gene is on, the *cI* repressor gene is off. As we shall see, these two genes regulate each other’s expression and thus, ultimately, the

decision between lytic and lysogenic growth of lambda. This decision between repressor gene transcription and *cro* gene transcription is a paradigmatic example of a molecular transcriptional switch.

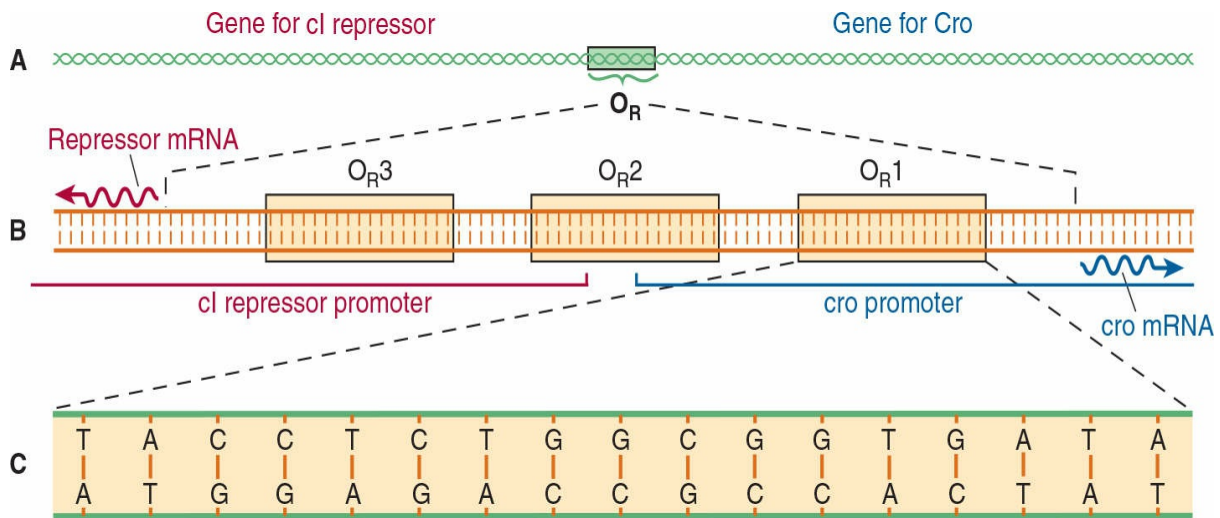

FIGURE 38–5 Genetic organization of the lambda lifestyle “molecular switch.” Right operator (O_R) is shown in increasing detail in this series of drawings. The operator is a region of the viral DNA some 70-bp long (A). To its left lies the gene encoding lambda repressor (*cI*), to its right the gene (*cro*) encoding the regulator protein Cro. When the operator region is enlarged (B), it is seen to include three subregions termed operators: O_{R1} , O_{R2} , and O_{R3} , each 17-bp long. These three DNA elements are recognition sites to which both λ *cI* repressor and Cro proteins can bind. The recognition sites overlap two divergent promoters—sequences of bases to which RNA polymerase binds in order to transcribe these genes into mRNA (wavy lines) that are translated into protein. Site O_{R1} is enlarged (C) to show its base sequence. (Reproduced, with permission, from Ptashne M, Johnson AD, Pabo CO: A genetic switch in a bacterial virus. *Sci Am* [Nov] 1982;247:128.)

The 80-bp lambda right operator, O_R , can be subdivided into three discrete, evenly spaced, 17-bp *cis*-active DNA elements that represent the binding sites for either of two bacteriophage lambda regulatory proteins. Importantly, the nucleotide sequences of these three tandemly arranged sites are similar but not identical (Figure 38–5B). The three related *cis*-elements, termed operators O_{R1} , O_{R2} , and O_{R3} , can be bound by either *cI* or Cro proteins. However, the relative affinities of *cI* and Cro for each of the sites vary, and this differential binding affinity is central to the

appropriate operation of the lambda phage lytic or lysogenic “molecular switch.” The DNA region between the *cro* and repressor genes also contains two promoter sequences that direct the binding of RNA polymerase in a specified orientation, where it commences transcribing adjacent genes. One promoter directs RNA polymerase to transcribe in the rightward direction and, thus, to transcribe *cro* and other distal genes, while the other promoter directs the transcription of the *cI* repressor gene in the leftward direction (Figure 38–5B).

The product of the *cI* repressor gene, the 236-amino-acid λ **cI repressor protein** is a **two-domain** molecule with **amino terminal DNA-binding domain (DBD)** and **carboxyl-terminal dimerization domain**. Association of one repressor protein with another forms a dimer. *cI* repressor **dimers** bind to operator DNA much more tightly than do monomers (Figure 38–6A to 38–6C).

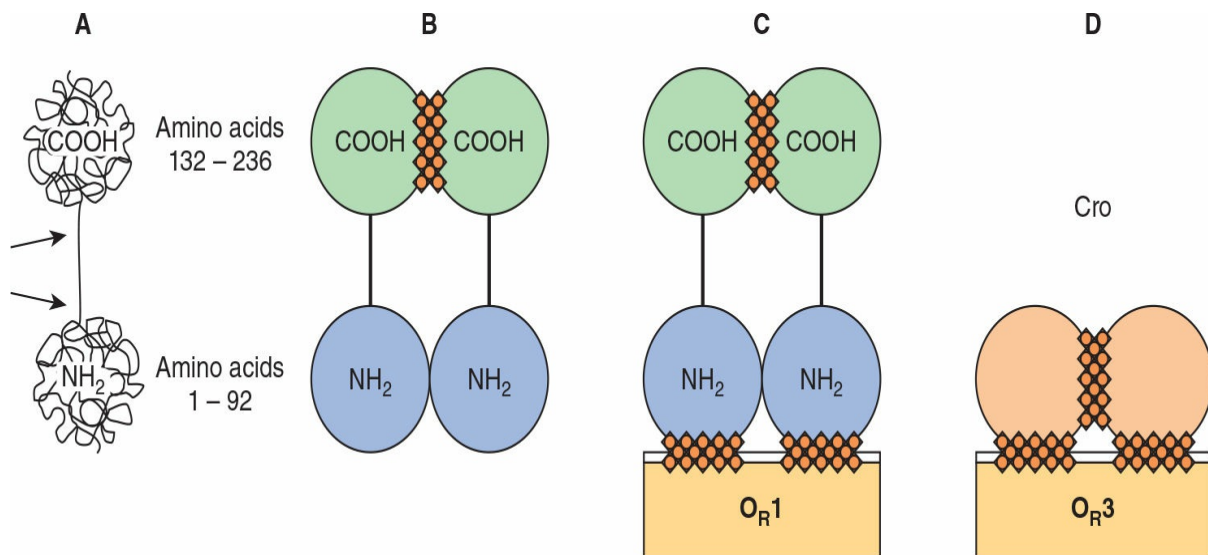

FIGURE 38–6 Schematic molecular structures of lambda regulatory proteins cI and Cro. The lambda repressor protein is a 236-amino-acid polypeptide. The chain folds itself into a dumbbell shape with two substructures: an amino terminal (NH₂) domain and a carboxyl-terminal (COOH) domain. The two domains are linked by a region of the chain that is less structured and susceptible to cleavage by proteases (indicated by the two arrows in **A**). Single repressor molecules (monomers) tend to reversibly associate to form dimers. (**B**) A dimer is held together mainly by contact between the carboxyl-terminal domains (hatching). *cI* repressor dimers bind to (and can dissociate from) the recognition sites in the operator region; they display differential affinities for the three operator sites, $O_{R1} > O_{R2} > O_{R3}$ (**C**). It is the DNA-binding domain (DBD) of the

repressor molecule that makes contact with the DNA (hatching). Cro (**D**) has a single domain that promotes cro–cro dimerization, and a DBD that promotes binding of dimers to operator. It is important that cro exhibits the highest affinity for O_R3, opposite the sequence binding preference of the cI protein. (Reproduced, with permission, from Ptashne M, Johnson AD, Pabo CO: A genetic switch in a bacterial virus. *Sci Am* [Nov] 1982;247:128.)

The product of the *cro* gene, the 66-amino-acid, 9-kDa **Cro protein**, has a single domain but also binds the operator DNA more tightly as a dimer (**Figure 38–6D**). The Cro protein's single domain mediates both operator binding and dimerization.

In a lysogenic bacterium—that is, a bacterium containing an integrated dormant lambda prophage—the lambda repressor dimer binds preferentially to O_R1 but in so doing, by a cooperative interaction, enhances the binding (by a factor of 10) of another repressor dimer to O_R2 (**Figure 38–7**). The affinity of repressor for O_R3 is the least of the three operator subregions. The binding of repressor to O_R1 has two major effects. First, occupancy of O_R1 by repressor blocks the binding of RNA polymerase to the rightward promoter and in that way prevents expression of *cro*. Second, as mentioned above, repressor dimer bound to O_R1 enhances the binding of repressor dimer to O_R2. The binding of repressor to O_R2 has the important added effect of enhancing the binding of RNA polymerase to the leftward promoter that overlaps O_R3 and thereby enhances transcription and subsequent expression of the repressor gene. This enhancement of transcription is mediated through direct protein–protein interactions between promoter-bound RNA polymerase and O_R2-bound repressor, much as described above for CAP protein and RNA polymerase on the *lac* operon. Thus, the λ cI protein is both a negative regulator, by preventing transcription of *cro*, and a positive regulator, by enhancing transcription of its own gene, *cI*. This dual effect of repressor is responsible for the stable state of the dormant lambda bacteriophage; not only does the repressor prevent expression of the genes necessary for lysis, but it also promotes expression of itself to stabilize this state of differentiation. In the event that intracellular repressor protein concentration becomes very high, the excess repressor will bind to O_R3 and by so doing diminish transcription of the repressor gene from the

leftward promoter, by blocking RNAP binding to the cI promoter, until the repressor concentration drops and repressor dissociates from O_R3 . Similar examples of repressor proteins also having the ability to activate transcription have been observed in eukaryotes.

Prophage

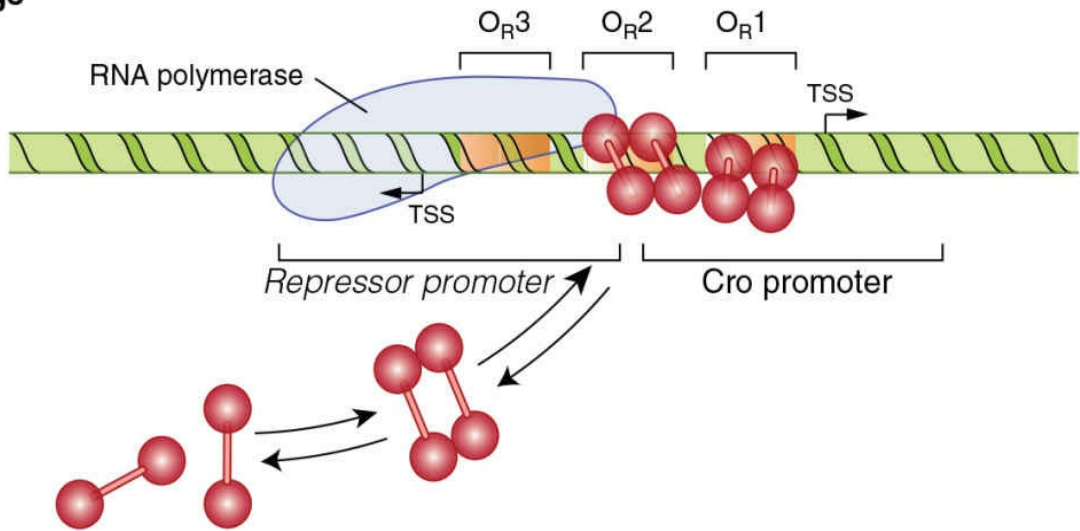

Induction (1)

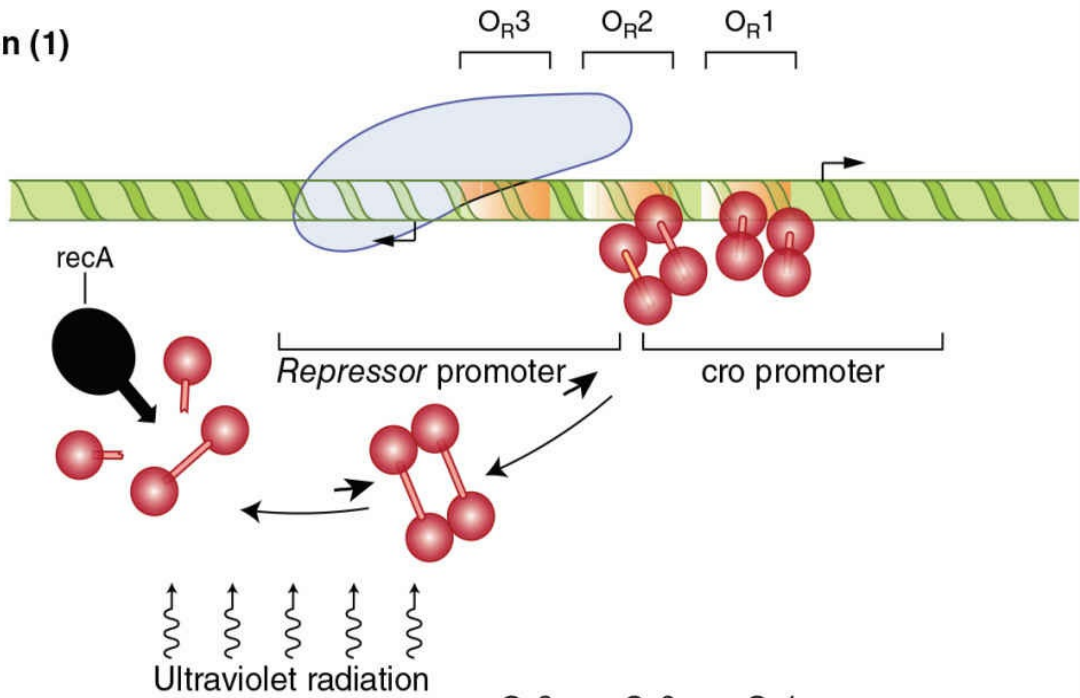

Induction (2)

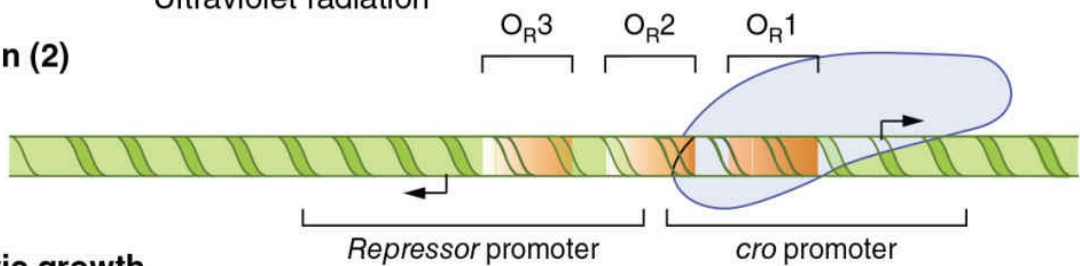

Early lytic growth

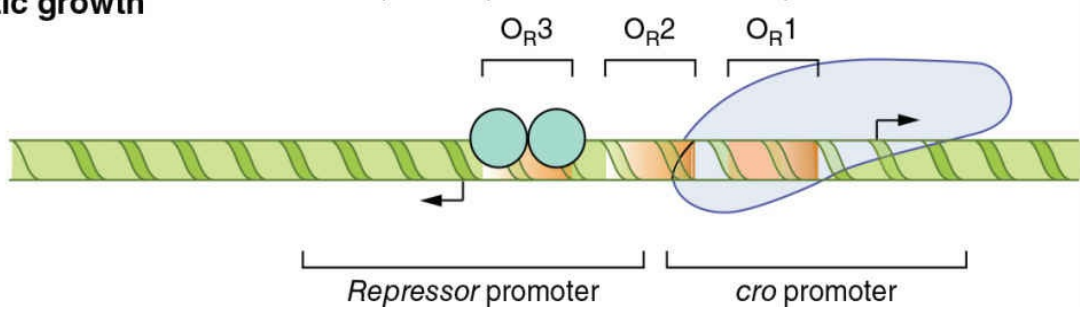

FIGURE 38–7 Configuration of the lytic/lysogenic switch is shown at four stages of the lambda life cycle. The lysogenic pathway (in which the virus remains dormant as a prophage) is selected when a repressor dimer binds to O_{R1} , thereby making it likely that O_{R2} will be bound immediately by another dimer due to the cooperative nature of cI - O_R DNA binding. In the prophage (**top**), the repressor dimers bound at O_{R1} and O_{R2} prevent RNA polymerase from binding to the rightward *cro* promoter and so block the synthesis of *cro* (negative control). Simultaneously these DNA-bound cI proteins enhance the binding of polymerase to the leftward promoter (positive control), with the result that the repressor gene is transcribed into RNA (initiation at *cI* gene transcription start site; TSS) and more repressor is synthesized, maintaining the lysogenic state. The prophage is induced (**middle**) when ultraviolet radiation activates the protease *recA*, which cleaves cI repressor monomers. **Induction (1)** The equilibrium of free monomers, free dimers, and bound dimers is thereby shifted by mass action, and dimers dissociate from the operator sites. RNA polymerase is no longer stimulated to bind to the leftward promoter, so that repressor is no longer synthesized. As induction proceeds, **Induction (2)** all the operator sites become vacant, thus polymerase can bind to the rightward promoter and *cro* is synthesized (*cro* TSS shown). During early lytic growth, a single *cro* dimer binds to O_{R3} (light blue shaded circles), the site for which it has the highest affinity thereby occluding the *cI* promoter. Consequently, RNA polymerase cannot bind to the leftward promoter, but the rightward promoter remains accessible. Polymerase continues to bind there, transcribing *cro* and other early lytic genes. Lytic growth ensues (**bottom**). (Reproduced, with permission, from Ptashne M, Johnson AD, Pabo CO: A genetic switch in a bacterial virus. *Sci Am* [Nov] 1982;247:128.)

With such a stable, repressive, cI -mediated, lysogenic state, one might wonder how the lytic cycle could ever be entered. However, this process does occur quite efficiently. When a DNA-damaging signal, such as ultraviolet light, strikes the lysogenic host bacterium, fragments of single-stranded DNA are generated that activate a specific coprotease coded by a bacterial gene and referred to as *recA* (Figure 38–7). The activated *recA* protease hydrolyzes the portion of the repressor protein that connects the amino-terminal and carboxyl-terminal domains of that molecule (see Figure 38–6A). Such cleavage of the repressor domains causes the repressor dimers to dissociate, which in turn causes dissociation of the

repressor molecules from O_{R2} and eventually from O_{R1} . The effects of removal of repressor from O_{R1} and O_{R2} are predictable. RNA polymerase immediately has access to the rightward promoter and commences transcribing the *cro* gene, and the enhancement effect of the repressor at O_{R2} on leftward transcription is lost (Figure 38–7).

The resulting newly synthesized Cro protein also binds to the operator region as a dimer, but as noted above, its order of preference is opposite to that of repressor (Figure 38–7). That is, Cro binds most tightly to O_{R3} , but there is no cooperative effect of Cro at O_{R3} on the binding of Cro to O_{R2} . At increasingly higher concentrations of Cro, the protein will bind to O_{R2} and eventually to O_{R1} .

Occupancy of O_{R3} by Cro immediately turns off transcription from the leftward *cI* promoter and in that way prevents any further expression of the repressor gene. The molecular switch is thus completely “thrown” in the lytic direction. The *cro* gene is now expressed, and the repressor gene is fully turned off. This event is irreversible, and the expression of other lambda genes begins as part of the lytic cycle. When Cro repressor concentration becomes quite high, it will eventually occupy O_{R1} and in so doing reduce the expression of its own gene, a process that is necessary in order to effect the final stages of the lytic cycle.

The three-dimensional structures of Cro and of the lambda repressor protein have been determined by x-ray crystallography, and models for their binding and effecting the above-described molecular and genetic events have been proposed and tested. Both bind to DNA using helix-turn-helix DBD motifs (see below). Along with regulation of the expression of the *lac* operon, the λ molecular switch described here provides arguably the best understanding of the molecular events involved in gene transcription activation and repression.

Detailed analysis of the λ repressor led to the important concept that transcription regulatory proteins have several functional domains. For example, lambda repressor binds to DNA with high affinity. Repressor monomers form dimers, cooperatively interact with each other, and repressor interacts with RNA polymerase, to enhance or block promoter binding or RNAP open complex formation (see Figure 36–3). The protein-DNA interface and the three protein-protein interfaces all involve separate and distinct domains of the repressor molecule. As will be noted below (see Figure 38–19), this is a characteristic that is typical of most molecules that regulate transcription.

SPECIAL FEATURES ARE INVOLVED IN REGULATION OF EUKARYOTIC GENE TRANSCRIPTION

Most of the DNA in prokaryotic cells is organized into genes, and since the DNA is not compacted with nucleosomal histones, it always has the potential to be transcribed if appropriate positive and negative *trans*-factors are present in a given cell in an active form. A very different situation exists in eukaryotic cells where relatively little of the total DNA is organized into mRNA-encoding genes and their associated regulatory regions. The function of the extra DNA is being actively investigated (ie, [Chapter 39](#); the ENCODE Projects). More importantly, as described in [Chapter 35](#), the DNA in eukaryotic cells is extensively folded and packed into the protein-DNA complex called chromatin. Histones are an important part of this complex since they both form the structures known as nucleosomes (see [Chapter 35](#)) and also factor significantly into gene regulatory mechanisms as outlined below.

The Chromatin Template Contributes Importantly to Eukaryotic Gene Transcription Control

Chromatin structure provides an additional level of control of gene transcription. As discussed in [Chapter 35](#), large regions of chromatin are transcriptionally inactive while others are either active or potentially active. With few exceptions, each cell contains the same complement of genes, hence, the development of specialized organs, tissues, and cells, and their function in the intact organism depend on the differential expression of genes.

Some of this differential expression is achieved by having different regions of chromatin available for transcription in cells from various tissues. For example, the DNA containing the β -globin gene cluster is in “**active**” **chromatin** in the reticulocyte but in “**inactive**” **chromatin** in muscle cells. All the factors involved in the determination of active chromatin have not been elucidated. The presence of nucleosomes and of complexes of histones and DNA (see [Chapter 35](#)) certainly provides a barrier against the ready association of transcription factors with specific DNA regions. The dynamics of the formation and disruption of nucleosome structure are therefore an important part of eukaryotic gene regulation.

Histone covalent modification, also dubbed **the histone code**, is an important determinant of gene activity. Histones are subjected to a wide range of specific posttranslational modifications (see [Table 35–1](#)). These modifications are dynamic and reversible. Histone acetylation and deacetylation are best understood. The surprising discovery that histone acetylase and other enzymatic activities are associated with the coregulators involved in regulation of gene transcription (see [Chapter 42](#) for specific examples) has provided a new concept of gene regulation. Acetylation is known to occur on lysine residues in the amino terminal tails of histone molecules, and has been consistently correlated with either active transcription, or alternatively, transcriptional potential. Histone acetylation reduces the positive charge of these tails and likely contributes to a decrease in the binding affinity of histone for the negatively charged DNA. Moreover, such covalent modification of the histones creates new binding, or docking sites for additional proteins such as ATP-dependent chromatin remodeling complexes that contain subunits that carry structural domains that specifically bind to histones that have been subjected to coregulator-deposited PTMs. These complexes can increase accessibility of adjacent DNA sequences by removing or otherwise altering nucleosomal histones. Together then coregulators (chromatin modifiers and chromatin remodellers), working in conjunction, can “open up” gene promoters and regulatory regions, facilitating binding of other *trans*-factors and RNA polymerase II and GTFs (see [Figures 36–10](#) and [36–11](#)). Histone deacetylation catalyzed by transcriptional corepressors would have the opposite effect. Different proteins with specific acetylase and deacetylase activities are associated with various components of the transcription apparatus. The proteins that catalyze the histone PTMs are sometimes referred to as “**code writers**” while the proteins that recognize, bind, and thus interpret these histone PTMs are termed “**code readers**” and the enzymes that remove histone PTMs are called “**code erasers.**” (The analogy to signal transduction, with its kinases, phosphatases and phospho-amino acid binding proteins should be apparent—see [Chapter 42](#).) Collectively then, these histone PTMs represent a very dynamic, potentially information-rich source of regulatory information. The exact rules and mechanisms defining the specificity of these various processes are under investigation. Some specific examples are illustrated in [Chapter 42](#). A variety of commercial enterprises are working to develop drugs that specifically alter the activity of the proteins that orchestrate the histone code.

In addition to the histone code (see [Chapter 35](#)) and its effects on all

DNA-mediated reactions, the **methylation of deoxycytidine residues, 5MeC**, (in the sequence 5'-^{me}CpG-3') in DNA has important effects on chromatin, some of which lead to a decrease in gene transcription. For example, in mouse liver, only the unmethylated ribosomal genes can be expressed, and there is evidence that many animal viruses are not transcribed when their DNA is methylated. Acute demethylation of 5MeC residues in specific regions of steroid hormone inducible genes has been associated with an increased rate of transcription of the gene. However, it is not yet possible to generalize that methylated DNA is transcriptionally inactive, that all inactive chromatin is methylated, or that active DNA is not methylated.

Finally, the binding of specific transcription factors to cognate DNA elements may result in disruption of nucleosomal structure. Most eukaryotic genes have multiple protein-binding DNA elements. The serial binding of transcription factors to these elements—in a combinatorial fashion—may either directly disrupt the structure of the nucleosome, prevent its reformation, or recruit, via protein–protein interactions, multiprotein coregulator complexes that have the ability to covalently modify and/or remodel nucleosomes. These reactions result in chromatin-level structural changes that in the end increase or decrease DNA accessibility to other factors and the transcription machinery.

Eukaryotic DNA that is in an “active” region of chromatin can be transcribed. As in prokaryotic cells, a **promoter** dictates where the RNA polymerase will initiate transcription, but the promoter in mammalian cells (see [Chapter 36](#)) is more complex. Additional complexity is added by elements or factors that enhance or repress transcription, define tissue-specific expression, and modulate the actions of many effector molecules. Finally, recent results suggest that gene activation and repression might occur when particular genes move into or out of different subnuclear compartments or locations.

Epigenetic Mechanisms Contribute Importantly to the Control of Gene Transcription

The molecules and regulatory biology described above contributes importantly to transcriptional regulation. Indeed, in recent years the role of covalent modification of DNA and histone (and nonhistone) proteins and the newly discovered ncRNAs has received tremendous attention in the field of gene regulation research, particularly through investigation into how such chemical modifications and/or molecules stably alter gene

expression patterns without altering the underlying DNA gene sequence. This field of study has been termed **epigenetics**. As mentioned in [Chapter 35](#), one aspect of these mechanisms, PTMs of histones has been dubbed the **histone code** or histone epigenetic code. The term “epigenetics” means “above genetics” and refers to the fact that these regulatory mechanisms do not change the underlying regulated DNA sequence, but rather simply the expression patterns, or function, of this DNA. Epigenetic mechanisms play key roles in the establishment, maintenance, and reversibility of transcriptional states. A key feature of epigenetic mechanisms is that the controlled transcriptional on/off states can be maintained through multiple rounds of cell division. This observation indicates that there must be robust, biochemically based mechanisms to maintain and stably propagate these epigenetic states.

Two forms of epigenetic signals, *cis*- and *trans*-epigenetic signals, can be described; these are schematically illustrated in [Figure 38–8](#). A simple *trans*-signaling event composed of positive transcriptional feedback mediated by an abundant, diffusible transactivator that efficiently partitions roughly equally between mother and daughter cell at each division is depicted in [Figure 38–8A](#). So long as the indicated, transcription factor is expressed at a sufficient level to allow all subsequent daughter cells to inherit the *trans*-epigenetic signal (transcription factor), such cells will have the cellular or molecular phenotype dictated by the other target genes of this transcriptional activator. Shown in [Figure 38–8](#) panel B is an example of how a *cis*-epigenetic signal (here as a specific 5MeCpG methylation mark) can be stably propagated to the two daughter cells following cell division. The hemi-methylated (ie, only one of the two DNA strands is 5MeC modified) DNA mark generated during DNA replication directs the methylation of the newly replicated strand through the action of ubiquitous maintenance DNA methylases. This 5MeC methylation results in both DNA daughter strands having the complete *cis*-epigenetic mark.

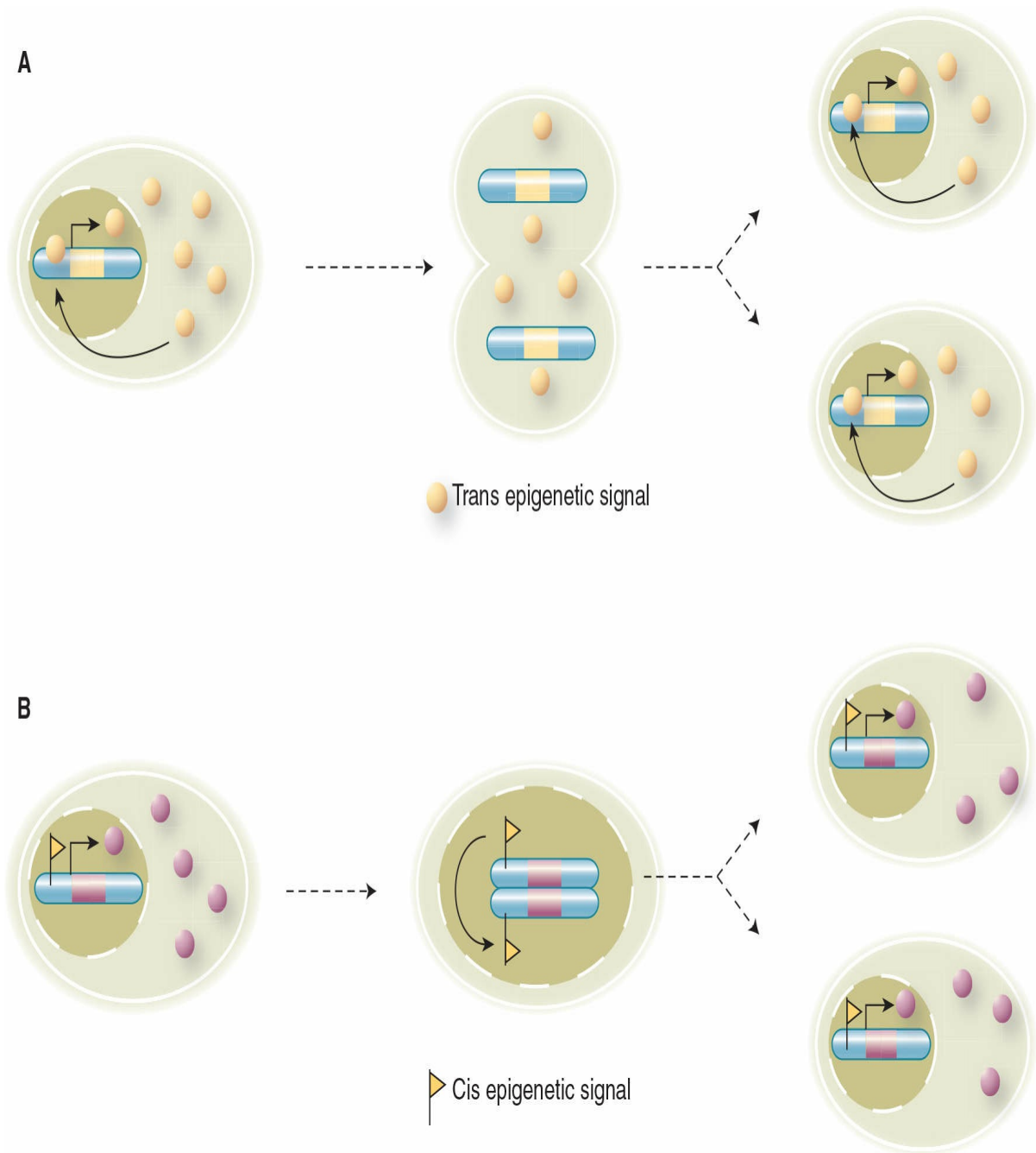

FIGURE 38–8 *cis*- and *trans*-epigenetic signals. **(A)** An example of an epigenetic signal that acts in *trans*. A DNA-binding transactivator protein (yellow circle) is transcribed from its cognate gene (yellow bar) located on a particular chromosome (blue). The expressed protein is freely diffusible between nuclear and cytoplasmic compartments. Note that excess transactivator reenters the nucleus following cell division, binds to its own gene, and activates transcription in both daughter cells. This cycle reestablishes the positive feedback loop in effect prior to cell division, and thereby enforces stable expression of this transcriptional activator protein in both cells. **(B)** A *cis*-epigenetic signal; a gene (pink) located on a

particular chromosome (blue) carries a *cis*-epigenetic signal (small yellow flag) within the regulatory region upstream of the pink gene transcription unit. In this case, the epigenetic signal is associated with active gene transcription and subsequent gene product production (pink circles). During DNA replication, the newly replicated chromatid serves as a template that both elicits and templates the introduction of the same epigenetic signal, or mark, on the newly synthesized, unmarked chromatid. Consequently, both daughter cells contain the pink gene in a similarly *cis*-epigenetically marked state, which ensures expression in an identical fashion in both cells. See text for more detail. (Image taken from: Bonasio, R, Tu S, Reinberg D: Molecular signals of epigenetic states. Science 2010;330:612-616. Reprinted with permission from AAAS.)

Both *cis*- and *trans*-epigenetic signals can result in stable and heritable expression states, and therefore generally represent type C gene expression responses (ie, [Figure 38–1](#)). However, it is important to note that both states can be reversed if either the *trans*- or *cis*-epigenetic signals are removed by, for example, extinguishing the expression of the enforcing transcription factor (*trans*-signal) or by completely removing a DNA *cis*-epigenetic signal (via DNA demethylation). Enzymes have been described that can remove both protein PTMs and 5MeC modifications.

Stable transmission of epigenetic on/off states can be affected by multiple molecular mechanisms. Shown in [Figure 38–9](#) are three ways by which *cis*-epigenetic marks can be propagated through a round of DNA replication. The first example of epigenetic mark transmission involves the propagation of DNA 5MeC marks, and occurs as described above in [Figure 38–8](#). The second example of epigenetic state transmission illustrates how a nucleosomal histone PTM (in this example, Lysine K-27 trimethylated histone H3; H3K27me3) can be propagated. In this example immediately following DNA replication, both H3K27me3-marked and H3-unmarked nucleosomes randomly reform on both daughter DNA strands. The **polycomb repressive complex 2 (PRC2)**, composed of EED-SUZ12-EZH2 and RbAP subunits, binds to the nucleosome containing the preexisting H3K27me3 mark via the EED subunit. Binding of PRC2 to this histone mark stimulates the methylase activity of the EZH2 subunit of PRC2, which results in the local methylation of nucleosomal H3. Histone H3 methylation thus causes the full, stable transmission of the H3K27me3 epigenetic mark to both chromatids. Finally, locus/sequence-specific targeting of nucleosomal histone epigenetic *cis*-signals can be attained through the action of lncRNAs as depicted in [Figure 38–9](#), panel C. Here a

specific ncRNA interacts with target DNA sequences and the resulting RNA–DNA complex is recognized by RBP, an RNA-binding protein. Then, likely through a specific adaptor protein (A), the RNA-DNA-RBP complex recruits a **chromatin modifying complex (CMC)** that locally modifies nucleosomal histones. Again, this mechanism leads to the transmission of a stable epigenetic mark.

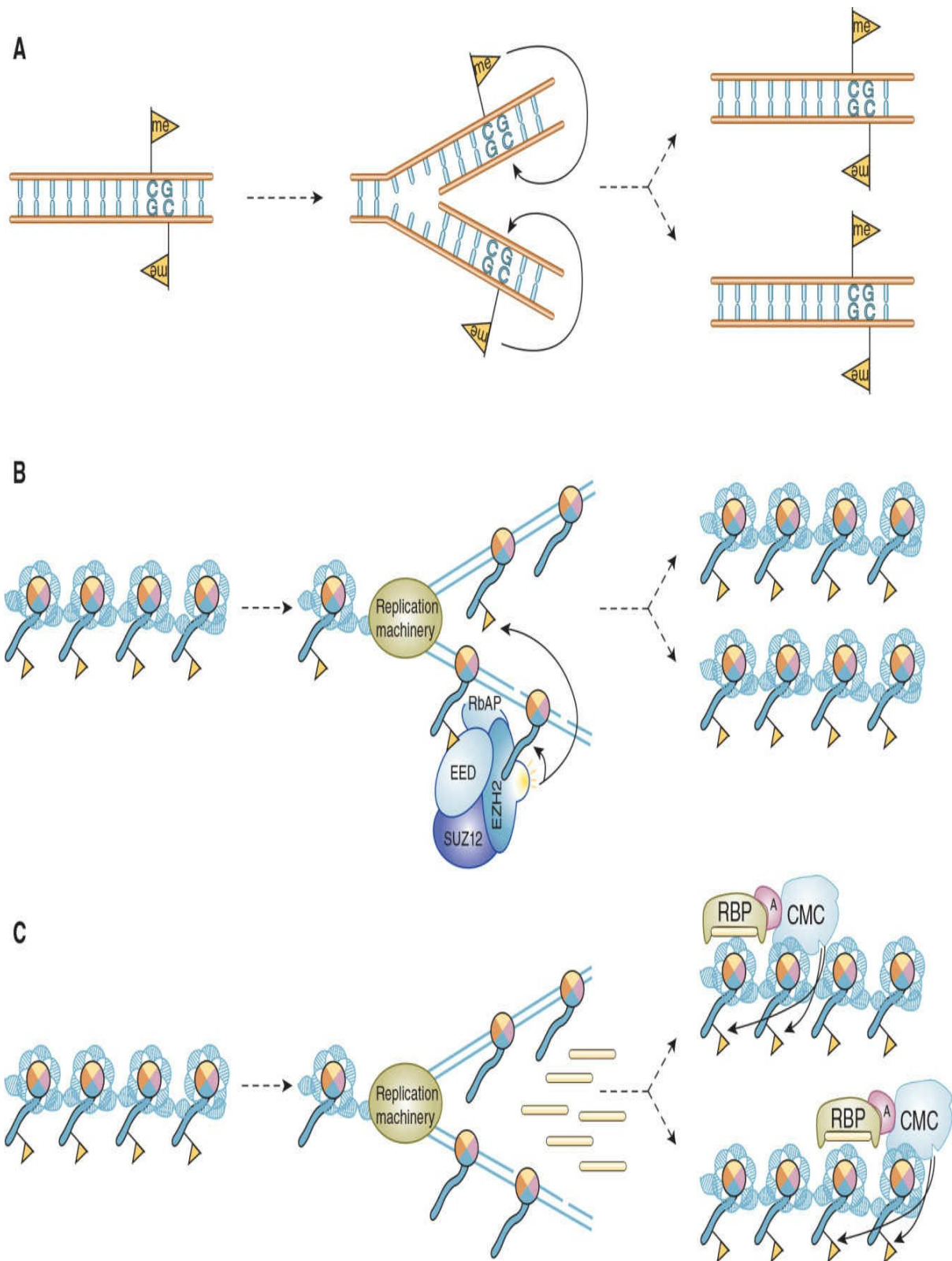

FIGURE 38–9 Mechanisms for the transmission and propagation of epigenetic signals following a round of DNA replication. (A) Propagation of a 5MeC signal (yellow flag; see [Figure 38–8B](#)). (B) Propagation of a histone PTM epigenetic signal (H3K27me) that is

mediated through the action of the PRC2, a chromatin modifying complex, or CMC. PRC2 is composed of EED, EZH2 histone methylase, RbAP, and SUZ12 subunits. Note that in this context, PRC2 is both a histone code reader (via the methylated histone-binding domain in EED) and histone code writer (via the SET domain histone methylase within EZH2). Location-specific deposition of the histone PTM *cis*-epigenetic signal is targeted by the recognition of the H3K27me marks in preexisting nucleosomal histones (yellow flag). (C) Another example of the transmission of a histone epigenetic signal (yellow flag) except here signal-targeting is mediated through the action of small ncRNAs that work in concert with an RNA-binding protein (RBP), an adaptor (A) protein, and a CMC. See text for more detail. (Image taken from: Bonasio R, Tu S, Reinberg D: Molecular signals of epigenetic states. Science 2010;330:612-616. Reprinted with permission from AAAS.)

Additional work will be required to establish the complete molecular details of these epigenetic processes, determine how ubiquitously these mechanisms operate, identify the full complement of molecules involved, and genes controlled. Epigenetic signals are critically important to gene regulation as evidenced by the fact that mutations and/or overexpression of many of the molecules that contribute to epigenetic control lead to human disease.

Certain DNA Elements Enhance or Repress Transcription of Eukaryotic Genes

In addition to gross changes in chromatin affecting transcriptional activity, certain DNA elements facilitate or enhance initiation at the promoter and hence are termed **enhancers**. Enhancer elements, which typically contain multiple binding sites for transactivator proteins, differ from the promoter in notable ways. They can exert their positive influence on transcription even when separated by tens of thousands of base pairs from a promoter; they work when oriented in either direction; and they can work upstream (5') or downstream (3') from the promoter. Experimentally, enhancers can be shown to be promiscuous, in that they can stimulate transcription of any promoter in their vicinity, and may act on more than one promoter. The viral SV40 enhancer can exert an influence on, for example, the transcription of β -globin by increasing its transcription 200-fold in cells containing both the SV40 enhancer and the β -globin gene on the same plasmid (see below and **Figure 38–10**); in this case the SV40 enhancer β -

globin gene was constructed using recombinant DNA technology—see [Chapter 39](#). The enhancer element does not produce a product that in turn acts on the promoter, since it is active only when it exists within the same DNA molecule as (ie, in *cis*, or physically linked to) the promoter. Enhancer-binding proteins are responsible for this effect. The exact mechanisms by which these transcription activators work are subject to intensive investigation. Enhancer-binding *trans*-factors, some of which are cell-type specific, while others are ubiquitously expressed, have been shown to interact with a plethora of other transcription proteins. These interactions include chromatin-modifying coactivators, mediator, as well as the individual components of the basal RNA polymerase II transcription machinery. Ultimately, transfactor-enhancer DNA-binding events result in an increase in the binding and/or activity of the basal transcription machinery on the linked promoter. Enhancer elements and associated binding proteins often convey nuclease hypersensitivity to those regions where they reside (see [Chapter 35](#)). A summary of the properties of enhancers is presented in [Table 38–2](#).

TABLE 38–2 Summary of the Properties of Enhancers

- Work when located long distances from the promoter
- Work when upstream or downstream from the promoter
- Work when oriented in either direction
- Can work with homologous or heterologous promoters
- Work by binding one or more proteins
- Work by recruiting chromatin-modifying coregulatory complexes
- Work by facilitating binding or function of the basal transcription complex at the *cis*-linked promoter

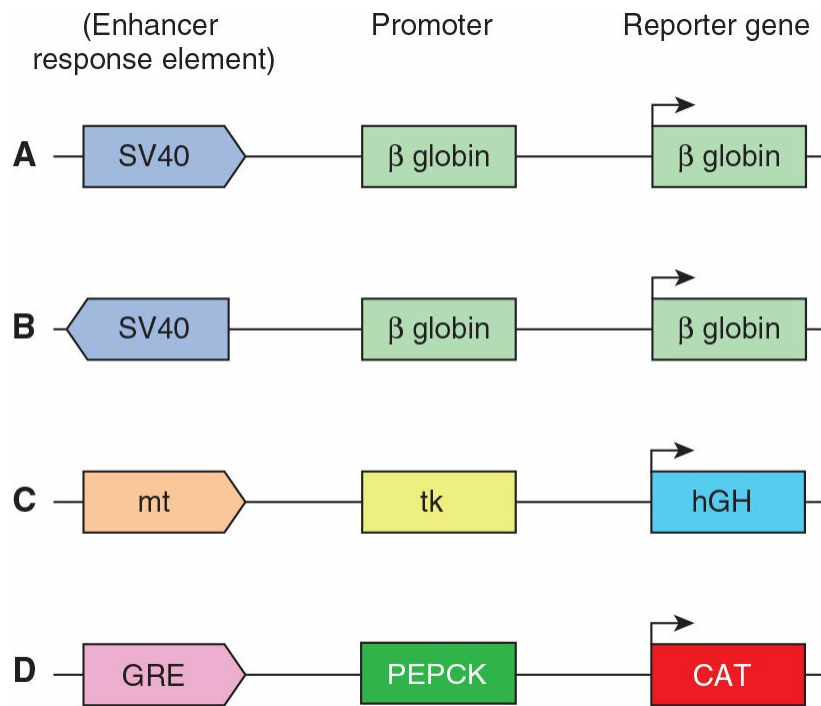

FIGURE 38–10 A schematic illustrating the methods used to study the organization and action of enhancers and other *cis*-acting regulatory elements. These model chimeric genes, all constructed by recombinant DNA techniques *in vitro* (see [Chapter 39](#)), consist of a reporter gene that encodes a protein that can be readily assayed, and that is not normally produced in the cells to be studied, a promoter that ensures accurate initiation of transcription, and the indicated enhancer (regulatory response) elements. In all cases, high-level transcription from the indicated chimeras depends on the presence of enhancers, which stimulate transcription ≥ 100 -fold over basal transcriptional levels (ie, transcription of the same chimeric genes containing just promoters fused to the indicated reporter genes). Examples (A) and (B) illustrate the fact that enhancers (eg, here SV40) work in either orientation and upon a heterologous promoter. Example (C) illustrates that the metallothionein (*mt*) regulatory element (which under the influence of cadmium or zinc induces transcription of the endogenous *mt* gene and hence the metal-binding *mt* protein) will work through the *herpes simplex virus* (HSV) thymidine kinase (*tk*) gene promoter to enhance transcription of the human growth hormone (*hGH*) reporter gene. In a separate experiment, this engineered genetic construct was introduced into the male pronuclei of single-cell mouse embryos and the embryos placed into the uterus of a surrogate mother to develop as transgenic animals. Offspring have been generated under these conditions, and in some the addition of zinc ions to their drinking water effects an increase in growth hormone expression in

liver. In this case, these transgenic animals have responded to the high levels of growth hormone by becoming twice as large as their normal litter mates. Example (D) illustrates that a glucocorticoid response element (GRE) enhancer will work through homologous (*PEPCK* gene) or heterologous gene promoters (not shown; ie, HSV *tk* promoter, SV40 promoter, β -globin promoter, etc) to drive expression of the chloramphenicol acetyltransferase (*CAT*) reporter gene.

One of the best-understood mammalian enhancer systems is that of the β -interferon gene. This gene is induced on viral infection of mammalian cells. One goal of the cell, once virally infected, is to attempt to mount an antiviral response—if not to save the infected cell, then to help to save the entire organism from viral infection. Interferon production is one mechanism by which this is accomplished. This family of proteins is secreted by virally infected cells. Secreted interferon interacts with neighboring cells to cause an inhibition of viral replication by a variety of mechanisms, thereby limiting the extent of viral infection. The enhancer element controlling induction of the β -interferon gene, which is located between nucleotides -110 and -45 relative to the transcription start site ($+1$), is well characterized. This enhancer consists of four distinct clustered *cis*-elements, each of which is bound by unique *trans*-factors. One *cis*-element is bound by the transacting factor NF- κ B (see [Figures 42–10](#) and [42–13](#)) one by a member of the interferon regulatory factor (IRF) family of transactivator factors, and a third by the heterodimeric leucine zipper factor ATF-2/c-Jun (see below). The fourth factor is the ubiquitous, abundant architectural transcription factor known as HMG I(Y). Upon binding to its A + T-rich binding sites, HMG I(Y) induces a significant bend in the DNA. There are four such HMG I(Y) binding sites interspersed throughout the enhancer. These sites play a critical role in forming a particular 3D structure, along with the aforementioned three *trans*-factors, by inducing a series of critically spaced DNA bends. Consequently, HMG I(Y) induces the cooperative formation of a unique, stereospecific, 3D structure within which all four factors are active when viral infection signals are sensed by the cell. The structure formed by the cooperative assembly of these four factors is termed the β -interferon enhanceosome ([Figure 38–11](#)), so named because of its obvious structural similarity to the nucleosome, which is also a unique three-dimensional protein-DNA structure that wraps DNA about a core assembly of proteins (see [Figures 35–1](#) and [35–2](#)). The enhanceosome, once formed, induces a large increase in β -interferon gene transcription upon virus infection. It is

not simply the protein occupancy of the linearly apposed *cis*-element sites that induces β -interferon gene transcription—rather, it is the formation of the enhanceosome proper that provides appropriate surfaces for the efficient recruitment of coactivators that results in the enhanced formation of the PIC on the *cis*-linked promoter and thus transcription activation.

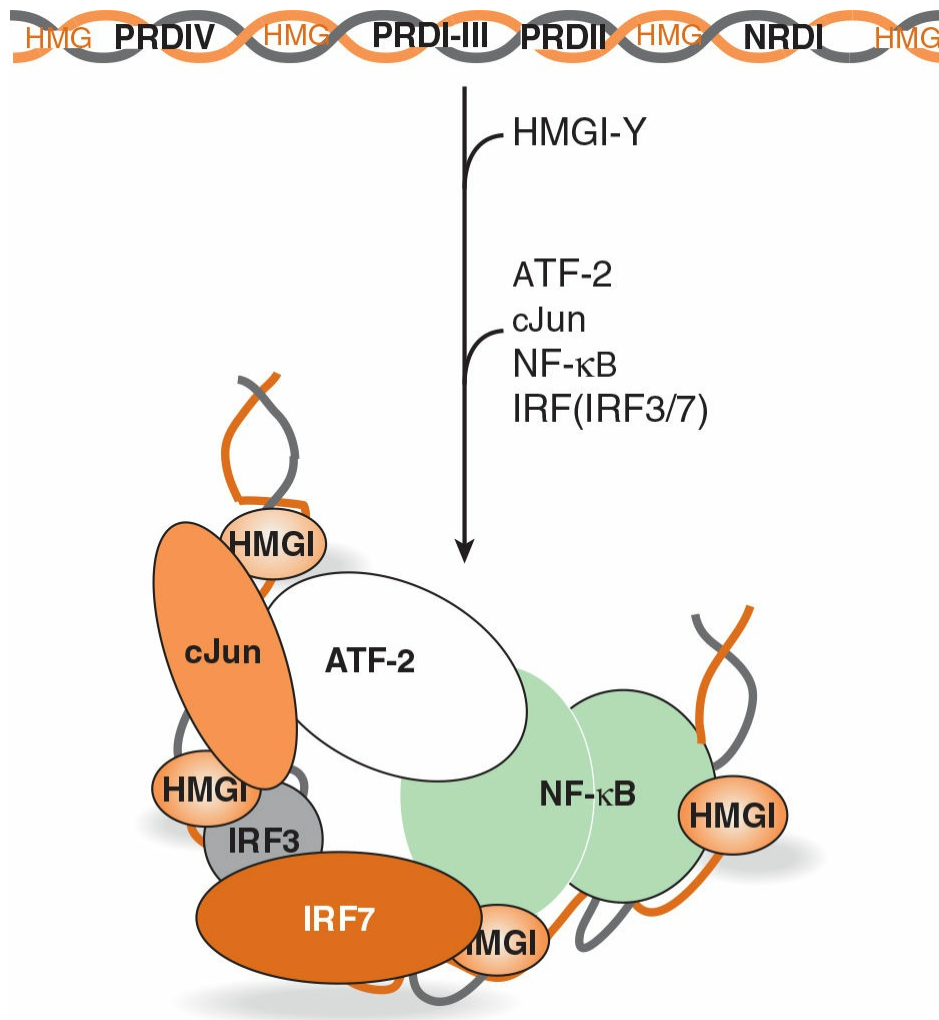

FIGURE 38–11 Formation and putative structure of the enhanceosome formed on the human β -interferon gene enhancer. Diagrammatically represented at the top is the distribution of the multiple *cis*-elements (HMG, PRDIV, PRDI-III, PRDII, NRDI) composing the β -interferon gene enhancer. The intact enhancer mediates transcriptional induction of the β -interferon gene (*IFNB1*) over 100-fold upon virus infection of human cells. The *cis*-elements of this modular enhancer represent the binding sites for the *trans*-factors HMG I(Y), cJun-ATF-2, IRF3-IRF7, and NF- κ B, respectively. The factors interact with these DNA elements in an obligatory, ordered, and highly cooperative fashion as indicated by the arrow. Initial binding of four HMG I(Y) proteins induces

sharp DNA bends in the enhancer, causing the entire 70- to 80-bp region to assume a high level of curvature. This curvature is integral to the subsequent highly cooperative binding of the other *trans*-factors since bending enables the DNA-bound factors to make critical direct protein–protein interactions that both contribute to the formation and stability of the enhanceosome and generate a unique 3D surface that serves to recruit chromatin-modifying coregulators that carry enzymatic activities (eg, Swi/Snf: ATPase, chromatin remodeler and P/CAF: histone acetyltransferase) as well as the general transcription machinery (RNA polymerase II and GTFs). Although four of the five *cis*-elements (PRDIV, PRDI-III, PRDII, NRDI) independently can modestly stimulate (~10-fold) transcription of a reporter gene in transfected cells (see [Figures 38–10](#) and [38–12](#)), all five *cis*-elements, in appropriate order, are required to form an enhancer that can appropriately stimulate transcription of *IFNB1* (ie, ≥100-fold) in response to viral infection of a human cell. This distinction indicates the strict requirement for appropriate enhanceosome architecture for efficient *trans*-activation. Similar enhanceosomes, involving distinct *cis*- and *trans*-factors and coregulators, are proposed to form on many other mammalian genes.

cis-Acting DNA elements that decrease the expression of specific genes are termed **silencers**. Silencers have also been identified in a number of eukaryotic genes. However, because fewer of these elements have been intensively studied, it is not possible to formulate accurate generalizations about their mechanism of action. That said, it is clear that as for gene activation, chromatin level covalent modifications of histones, and other proteins, by silencer-recruited repressors and corecruited multisubunit corepressors likely play central roles in these regulatory events.

Tissue-Specific Expression May Result From Either the Action of Enhancers or Repressors or a Combination of Both *cis*-Acting Regulatory Elements

Most genes are now recognized to harbor enhancer elements in various locations relative to their coding regions. In addition to being able to enhance gene transcription, some of these enhancer elements clearly possess the ability to do so in a tissue-specific manner. By fusing known or suspected tissue-specific enhancers or silencers to reporter genes (see below) and introducing these chimeric enhancer-reporter constructs via microinjection into single-cell embryos, one can create a transgenic animal

(see [Chapter 39](#)), and rigorously test whether a given test enhancer or silencer truly modulates expression in a cell- or tissue-specific fashion. This **transgenic animal** approach has proved useful in studying tissue-specific gene expression.

Reporter Genes Are Used to Define Enhancers & Other Regulatory Elements That Modulate Gene Expression

By ligating regions of DNA suspected of harboring regulatory sequences to various reporter genes (the **reporter** or **chimeric gene approach**) ([Figures 38–10, 38–12, and 38–13](#)), one can determine which regions in the vicinity of structural genes have an influence on their expression. Pieces of DNA thought to harbor regulatory elements, often identified by bioinformatic sequence alignments, are ligated to a suitable reporter gene and introduced into a host cell ([Figure 38–12](#)). Expression of the reporter gene will be increased if the DNA contains a particular enhancer. For example, addition of different hormones to separate cultures will increase expression of the reporter gene if the DNA contains a particular **hormone response DNA element (HRE)** ([Figure 38–13](#); see also [Chapter 42](#)). The location of the element can be pinpointed by using progressively shorter pieces of DNA, deletions, or point mutations ([Figure 38–13](#)).

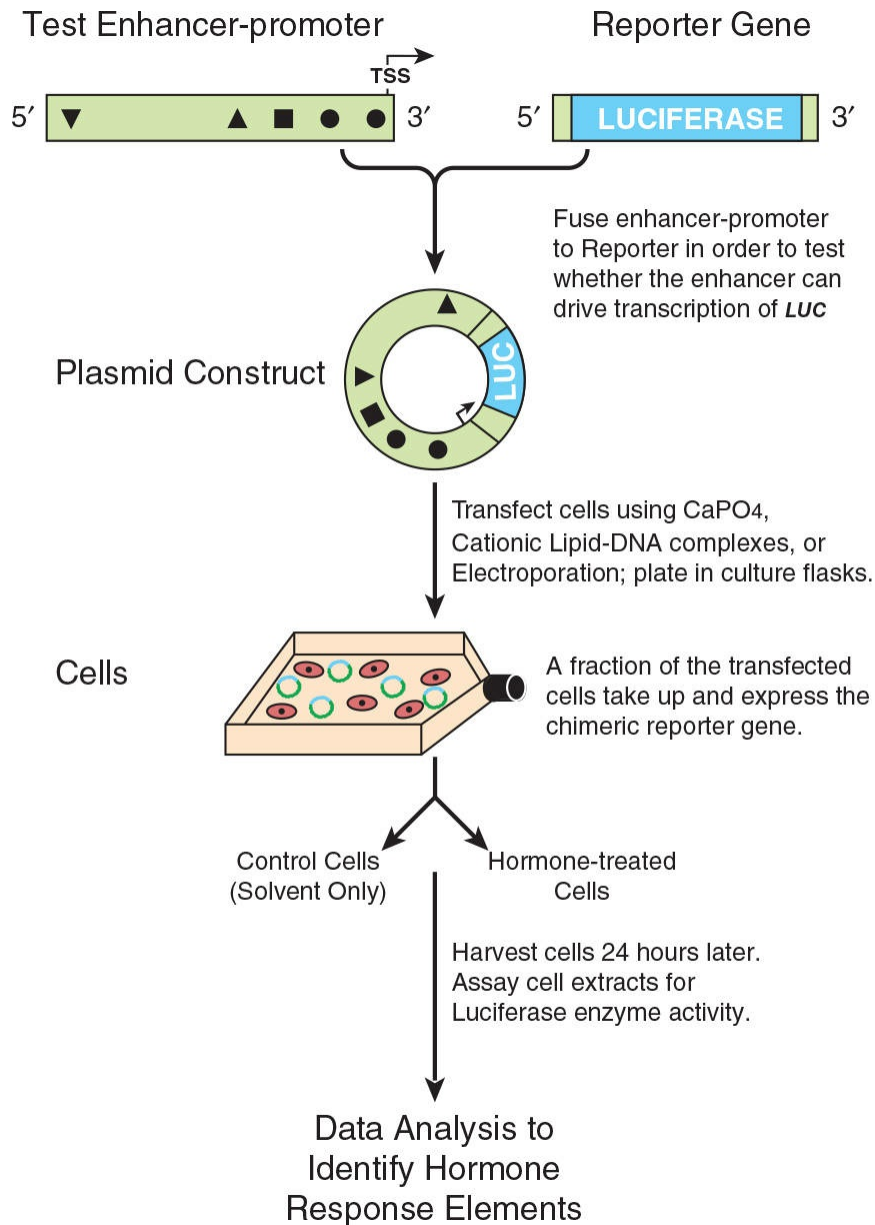

FIGURE 38–12 The use of reporter genes to define DNA regulatory elements. A DNA fragment bearing regulatory *cis*-elements (triangles, square, circles in diagram) from the gene in question—in this example, approximately 2 kb of 5'-flanking DNA and cognate promoter—is ligated into a plasmid vector that contains a suitable reporter gene—in this case, the enzyme firefly luciferase, abbreviated LUC. As noted in [Figure 38–10](#) in such experiments, the reporter cannot be present endogenously in the cells transfected. Consequently, any detection of these activities in a cell extract means that the cell was successfully transfected by the plasmid. Not shown here, but typically one cotransfects an additional reporter such as Renilla luciferase to serve as a transfection efficiency control. Assay conditions for the firefly and Renilla luciferases are different, hence the two activities can be sequentially assayed using the same cell extract. An

increase of firefly luciferase activity over the basal level, for example, after addition of one or more hormones, means that the region of DNA inserted into the reporter gene plasmid contains functional hormone response elements (HRE). Progressively shorter pieces of DNA, regions with internal deletions, or regions with point mutations can be constructed and inserted upstream of the reporter gene to pinpoint the response element (Figure 38–13). One caveat of this approach is that the transfected plasmid DNAs likely do not form “classical” chromatin structures.

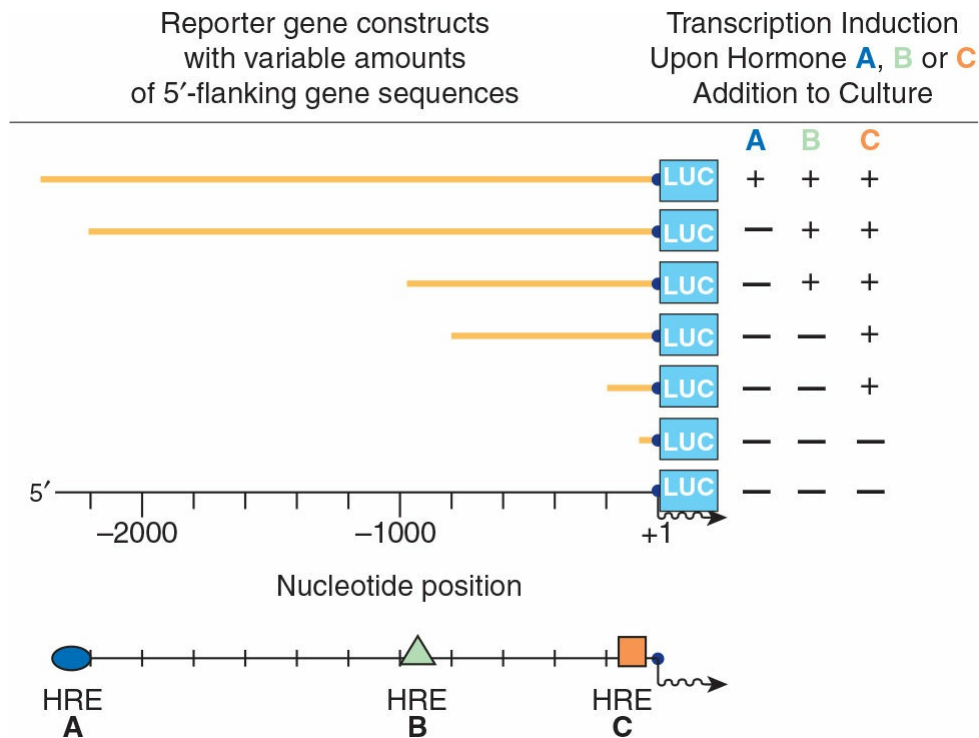

FIGURE 38–13 Mapping distinct hormone response elements (HREs) (A), (B), and (C) using the reporter gene–transfection approach. A family of reporter genes, constructed as described in Figures 38–10 and 38–12, can be transfected individually into a recipient cell. By analyzing when certain hormone responses are lost in comparison to the 5' deletion end point, specific hormone-response enhancer elements can be located and defined, ultimately with nucleotide-level precision (see summary, bottom).

This strategy, typically performed using transfected cells in culture (ie, cells induced to take up exogenous DNAs), has led to the identification of hundreds of enhancers, silencers/repressors such as tissue-specific elements, and hormone, heavy metal, and drug-response elements. The activity of a gene at any moment reflects the interaction of these numerous *cis*-acting DNA elements with their respective *trans*-acting factors.

Overall, transcriptional output is determined by the balance of positive and negative signaling to the transcription machinery. The challenge now is to figure out exactly how this regulation occurs at the molecular level so that we might ultimately have the ability to modulate gene transcription therapeutically.

Combinations of DNA Elements & Associated Proteins Provide Diversity in Responses

Prokaryotic genes are often regulated in an on-off manner in response to simple environmental cues. Some eukaryotic genes are regulated in the simple on-off manner, but the process in most genes, especially in mammals, is much more complicated. Signals representing a number of complex environmental stimuli may converge on a single gene. The response of the gene to these signals can have several physiologic characteristics. First, the response may extend over a considerable range. This is accomplished by having additive and synergistic positive responses counterbalanced by negative or repressing effects. In some cases, either the positive or the negative response can be dominant. Also required is a mechanism whereby an effector, such as a hormone, can activate some genes in a cell while repressing others and leaving still others unaffected. When all of these processes are coupled with tissue-specific element factors, considerable flexibility is afforded. These physiologic variables obviously require an arrangement much more complicated than an on-off switch. The collection and organization of DNA elements in a promoter specifies—via associated factors—how a given gene will respond, and how long a particular response is maintained. Some simple examples are illustrated in **Figure 38–14**.

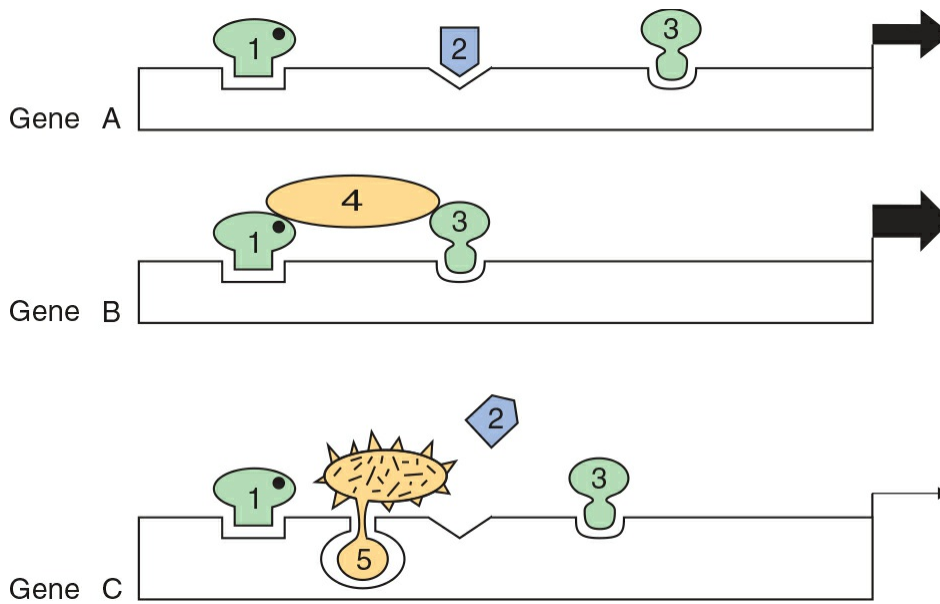

FIGURE 38–14 **Combinations of DNA elements and proteins provide diversity in the response of a gene.** Gene A is activated (the width of the arrow indicates the extent) by the combination of transcriptional activator proteins 1, 2, and 3 (with coactivators, as shown in [Figures 36–10](#) and [38–11](#)). Gene B is activated, in this case more effectively, by the combination of factors 1, 3, and 4; note that transcription factor 4 does not contact DNA directly in this example. The activators could form a linear bridge that links the basal machinery to the promoter, or alternatively, this could be accomplished by DNA looping, or 3D structure formation (ie, [Figure 38–11](#)). Regardless, the purpose is to direct the basal transcription machinery to the promoter. Gene C is inactivated by the combination of transcription factors 1, 5, and 3; in this case, factor 5 is shown to preclude the essential binding of factor 2 to DNA, as occurs in example A. If activator 1 promotes cooperative binding of repressor protein 5, and if activator 1 binding requires a ligand (solid dot), it can be seen how the ligand could activate one gene in a cell (gene A) and repress another (gene C) in the same cell.

Transcription Domains Can Be Defined by Locus Control Regions & Insulators

The large number of genes in eukaryotic cells and the complex arrays of transcription regulatory factors present an organizational problem. Why are some genes available for transcription in a given cell whereas others are not? If enhancers can regulate several genes from tens of kilobase distances and are not position- and orientation-dependent, how are they

prevented from triggering transcription of all *cis*-linked genes in the vicinity? Part of the solution to these problems is arrived at by having the chromatin arranged in functional units that restrict patterns of gene expression. This may be achieved by having the chromatin form a structure with the nuclear matrix or other physical entity or compartment within the nucleus. Alternatively, some regions are controlled by complex DNA elements called **locus control regions (LCRs)**. An LCR—with associated bound proteins—controls the expression of a cluster of genes. The best-defined LCR regulates expression of the globin gene family over a large region of DNA. Another mechanism is provided by **insulators**. These DNA elements, also in association with one or more proteins, prevent an enhancer from acting on a promoter on the other side of an insulator in another transcription domain. Insulators thus serve as transcriptional **boundary elements**. In the globin gene cluster, and many other genes, enhancer and promoter sequences are brought into physical contact via specific DNA looping events. The rules controlling such chromosome looping are currently under intense study.

SEVERAL MOTIFS COMPOSE THE DNA-BINDING DOMAINS OF REGULATORY TRANSCRIPTION FACTOR PROTEINS

The specificity involved in the control of transcription requires that regulatory proteins bind with high affinity and specificity to the correct region of DNA. Three unique motifs—the **helix-turn-helix**, the **zinc finger**, and the **leucine zipper**—account for many of these specific protein-DNA interactions. Examples of proteins containing these motifs are given in **Table 38–3**.

TABLE 38–3 Examples of Transcription Factors That Contain Various DNA-Binding Motifs

Binding Motif	Organism	Regulatory Protein
Helix-turn-helix	<i>E. coli</i>	lac repressor, CAP
	Phage	λ cl, cro, and 434 repressors
	Mammals	Homeobox proteins Pit-1, Oct1, Oct2
Zinc finger	<i>E. coli</i>	Gene 32 protein
	Yeast	Gal4
	<i>Drosophila</i>	Serendipity, hunchback
	Xenopus	TFIIIA
	Mammals	Steroid receptor family, Sp1
Leucine zipper	Yeast	GCN4
	Mammals	C/EBP, fos, Jun, Fra-1, CRE binding protein (CREB), <i>c-myc</i> , <i>n-myc</i> , <i>l-myc</i>

Comparison of the binding activities of the proteins that contain these motifs leads to several important generalizations.

1. Binding must be of high affinity to the specific site and of low affinity to other DNA.
2. Small regions of the protein make direct contact with DNA; the rest of the protein, in addition to providing the *trans*-activation domains, may be involved in the dimerization of monomers of the binding protein, may provide a contact surface for the formation of heterodimers, may provide one or more ligand-binding sites, or may provide surfaces for interaction with coactivators, corepressors, or the transcription machinery.
3. The protein-DNA interactions made by these proteins are maintained by hydrogen bonds, ionic interactions, and van der Waals forces.
4. The motifs found in these proteins are class-specific; their presence in a protein of unknown function suggests that the protein may bind to DNA.
5. Proteins with the helix-turn-helix or leucine zipper motifs form dimers, and their respective DNA-binding sites are symmetric palindromes. In

proteins with the zinc finger motif, the binding site is repeated two to nine times. These features allow for cooperative interactions between binding sites and enhance the degree and affinity of binding.

The Helix-Turn-Helix Motif

The first motif described was the **helix-turn-helix**. Analysis of the 3D structure of the lambda cro transcription regulator has revealed that each monomer consists of three antiparallel β sheets and three α helices (**Figure 38–15**). The dimer forms by association of the antiparallel β_3 sheets. The α_3 helices form the DNA recognition surface, and the rest of the molecule appears to be involved in stabilizing these structures. The average diameter of an α helix is 1.2 nm, which is the approximate width of the major groove in the B form of DNA.

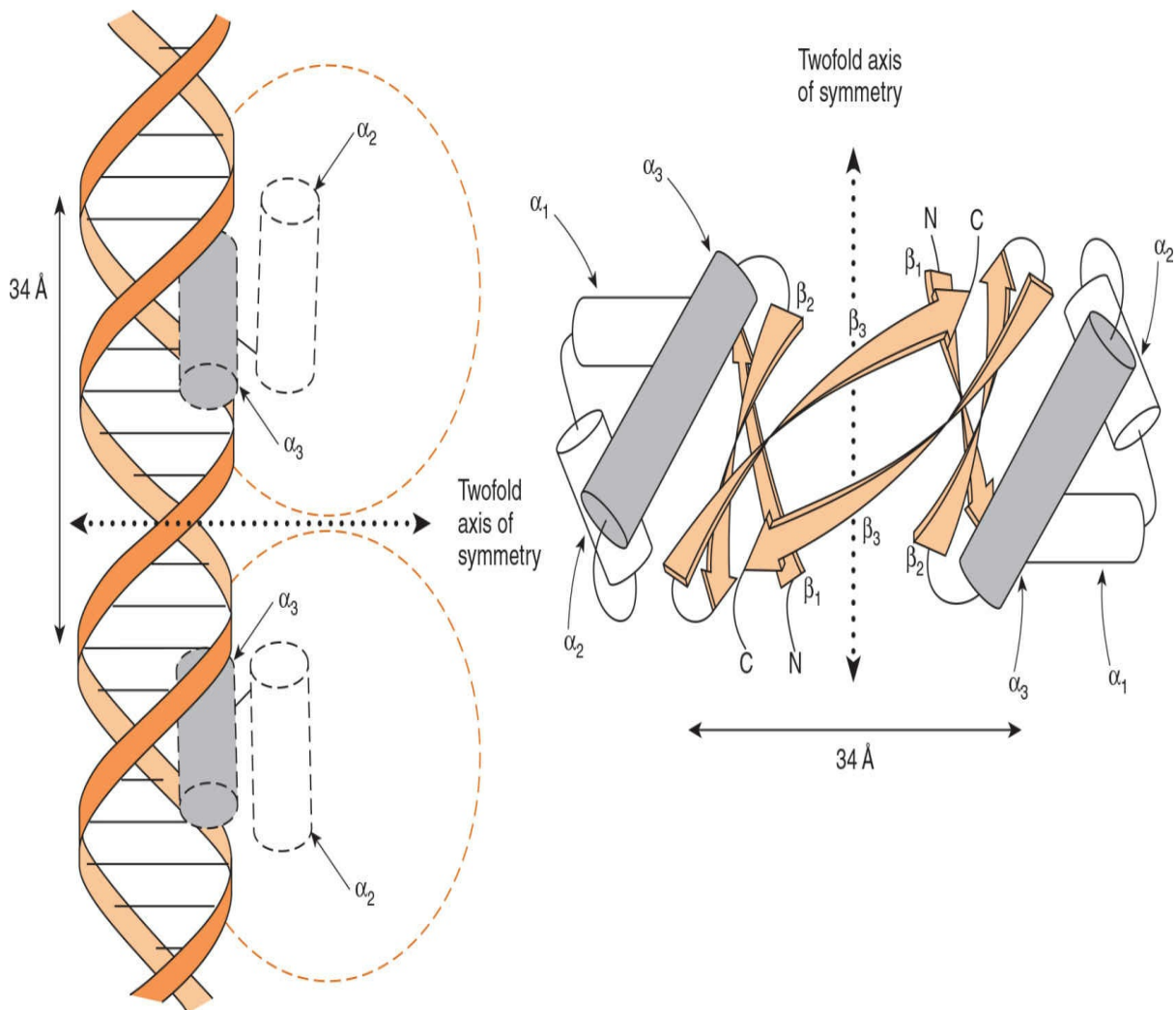

FIGURE 38–15 A schematic representation of the 3D structure of Cro protein and its binding to DNA by its helix-turn-helix motif (left).

The Cro monomer consists of three antiparallel β sheets (β_1 - β_3) and three α helices (α_1 - α_3). The helix-turn-helix (HTH) motif is formed because the α_3 and α_2 helices are held at about 90° to each other by a turn of four amino acids. The α_3 helix of Cro is the DNA recognition surface (**shaded**). Two monomers associate through interactions between the two antiparallel β_3 sheets to form a dimer that has a twofold axis of symmetry (**right**). A Cro dimer binds to DNA through its α_3 helices, each of which contacts about 5 bp on the same face of the major groove (see [Figures 34–2](#) and [38–6](#)). The distance between comparable points on the two DNA α helices is 34 Å, the distance required for one complete turn of the double helix. (Reprinted with permission from B Mathews.)

The DNA recognition domain of each Cro monomer interacts with 5 bp and the dimer-binding sites span 3.4 nm, allowing fit into successive half turns of the major groove on the same surface of DNA ([Figure 38–15](#)). X-ray analyses of the λ cI repressor, CAP (the cAMP receptor protein of *E. coli*), tryptophan repressor, and phage 434 repressor, all also display this dimeric helix-turn-helix structure that is present in eukaryotic DNA-binding proteins as well ([Table 38–3](#)).

The Zinc Finger Motif

The **zinc finger** was the second DNA-binding motif whose atomic structure was elucidated. It was known that the protein TFIIIA, a positive regulator of 5S RNA gene transcription, required zinc for activity. Structural and biophysical analyses revealed that each TFIIIA molecule contains nine zinc ions in a repeating coordination complex formed by closely spaced cysteine–cysteine residues followed 12 to 13 amino acids later by a histidine–histidine pair ([Figure 38–16](#)). In some instances— notably the steroid–thyroid nuclear hormone receptor family—the His–His doublet is replaced by a second Cys–Cys pair. The zinc finger motifs of the protein lie on one face of the DNA helix, with successive fingers alternatively positioned in one turn in the major groove. As is the case with the recognition domain in the helix-turn-helix protein, each TFIIIA zinc finger contacts about 5 bp of DNA. The importance of this motif in the action of steroid hormones is underscored by an “experiment of nature.” A single amino acid mutation in either of the two zinc fingers of the $1,25(\text{OH})_2\text{-D}_3$ receptor protein results in resistance to the action of this hormone and the clinical syndrome of rickets.

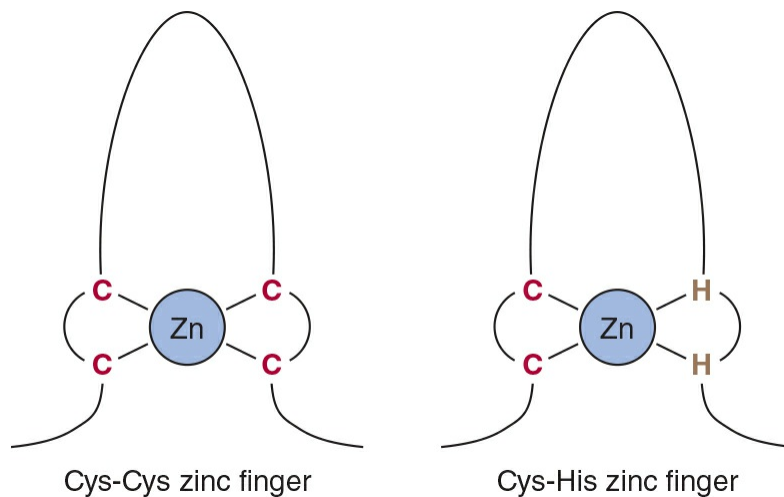

FIGURE 38–16 Zinc fingers are a series of repeated domains (two to nine) in which each is centered on a tetrahedral coordination with zinc. In the case of the DNA-binding transcription factor TFIIIA, the coordination is provided by a pair of cysteine residues (C) separated by 12 to 13 amino acids from a pair of histidine (H) residues. In other zinc finger proteins, the second pair also consists of C residues. Zinc fingers bind in the major groove, with adjacent fingers making contact with 5 bp along the same face of the helix.

The Leucine Zipper Motif

Analysis of a 30-amino-acid sequence in the carboxyl-terminal region of the enhancer-binding protein C/EBP revealed a novel structure, **the leucine zipper motif**. As illustrated in [Figure 38–17](#), this region of the protein forms an α helix in which there is a periodic repeat of leucine residues at every seventh position. This occurs for eight helical turns and four leucine repeats. Similar structures have been found in a number of other proteins associated with the regulation of transcription in all eukaryotes tested. This structure allows two identical or nonidentical monomers (eg, Jun–Jun or Fos–Jun) to “zip together” in a coiled coil and form a tight dimeric complex ([Figure 38–17](#)). This protein–protein interaction serves to enhance the association of the separate DBDs with their target DNA sites ([Figure 38–17](#)).

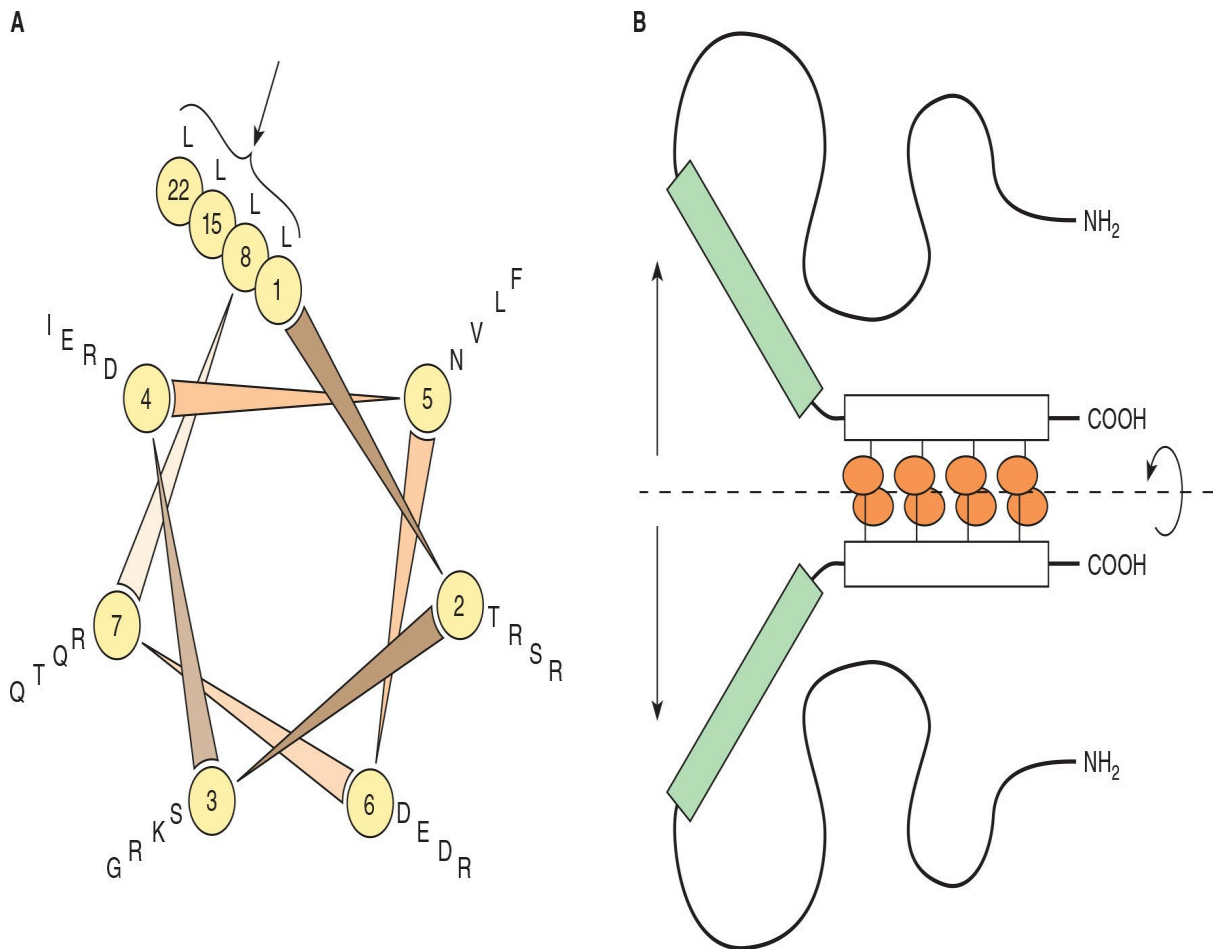

FIGURE 38–17 The leucine zipper motif. (A) Shown is a helical wheel analysis of a carboxyl-terminal portion of the DNA-binding protein C/EBP (see Table 36–3). The amino acid sequence is displayed end-to-end down the axis of a schematic α helix (see Figures 5–2 to 5–4). The helical wheel consists of seven spokes that correspond to the seven amino acids that comprise every two turns of the α helix. Note that leucine residues (L) occur at every seventh position (in this schematic C/EBP amino acid residues 1, 8, 15, 22; see arrow). Other proteins with “leucine zippers” have a similar helical wheel pattern. (B) A schematic model of the DNA-binding domain of C/EBP. Two identical C/EBP polypeptide chains are held in dimer formation by the leucine zipper domain of each polypeptide (denoted by the white rectangles and attached orange-shaded ovals). This association is required to hold the DNA-binding domains of each polypeptide (the green-shaded rectangles) in the proper conformation and register for DNA binding. (Reprinted with permission from S McKnight.)

THE DNA BINDING & TRANSACTIVATION DOMAINS OF MOST REGULATORY PROTEINS

ARE SEPARATE

DNA binding could result in a general conformational change that allows the bound protein to activate transcription, alternatively these two functions could be served by separate and independent domains. Domain swap experiments suggest that the latter is typically the case.

The *GAL1* gene product is involved in galactose metabolism in yeast. Transcription of this gene is positively regulated by the Gal4 protein, which binds to an upstream activator sequence (UAS), or enhancer, through an amino terminal **DBD**. To systematically test the contributions of the Gal4 AD and DBD to *GAL1* gene transcription activation, a series of domain swap experiments were performed (**Figure 38-18**). The amino terminal 73-amino-acid DBD of Gal4 was removed and replaced with the DBD of LexA, an *E. coli* DNA-binding protein. This domain swap resulted in a molecule that did not bind to the *GAL1* UAS and of course, did not activate the *GAL1* gene (**Figure 38-18**). If, however, the *lexA* operator—the DNA sequence normally bound by the LexA DBD—was inserted into the promoter region of the *GAL* gene to replace the normal *GAL1* enhancer, the hybrid protein bound to this promoter (at the substituted *lexA* operator) and it activated transcription of *GAL1*. This general experiment has been repeated many times with different heterologous DBDs. The results demonstrate that the carboxyl-terminal region of Gal4 contains a transcriptional **activation domain**, or **AD**. These data also demonstrate that the DBD and AD can function independently. The hierarchy involved in assembling gene transcription-activating complexes includes proteins that bind DNA and transactivate; others that form protein–protein complexes which bridge DNA-binding proteins to transactivating proteins; and others that form protein–protein complexes with components of coregulators or the basal transcription apparatus. A given protein may thus have several modular surfaces or domains that serve different functions (**Figure 38-19**). (Not shown here, but DNA-binding repressor proteins are organized similarly with separable DBDs and **silencing domains**, **SDs**. As described in **Chapter 36**, the primary purpose of these molecules is to facilitate the assembly and/or activity of the basal transcription apparatus on the *cis*-linked promoter.

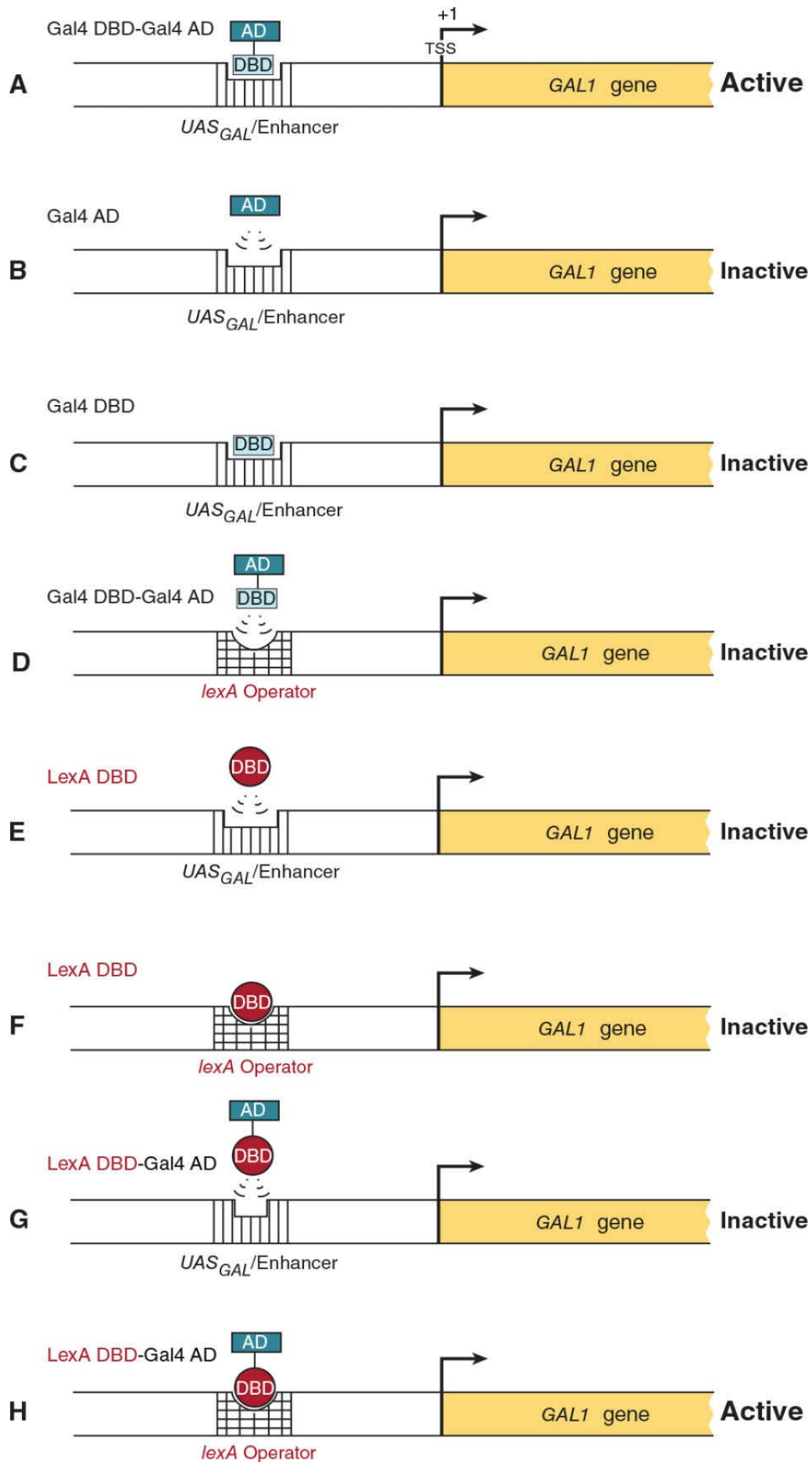

FIGURE 38–18 Domain-swap experiments demonstrate the independent nature of DNA-binding and transcription activation domains. The yeast *GAL1* gene contains an upstream activating sequence/enhancer (UASGAL/Enhancer) that is bound by the multi-domain DNA binding regulatory transcriptional activator protein Gal4. Gal4, like the lambda cI protein is modular, and contains an N-terminal DNA binding domain (DBD) and a C-terminal activation domain (AD). When the intact Gal4 transcription factor binds the *GAL1* UASGAL enhancer, activation of *GAL1* gene transcription ensues [(A); **Active**]. Control experiments demonstrate that all three *GAL1*-gene specific components [ie. cis- and trans-active components: UASGAL DNA enhancer, Gal4 DBD and Gal4 AD) are required for active transcription of the natural *GAL1* gene, as expected [(B), (C), (D), (E), (F)-all **Inactive**]. A chimeric protein, in which the DBD of Gal4 is replaced with the DBD of the *E coli* specific operator DNA binding protein LexA fails to stimulate *GAL1* transcription because the LexA DBD cannot bind to the UASGAL/Enhancer [(G); **Inactive**]. By contrast, the LexA DBD -Gal4 AD fusion protein does activate *GAL1* transcription when the *lexA* operator (the natural target for the *LexA* DBD) is inserted into the *GAL1* promoter region, replacing the normal UASGAL/Enhancer [(H); **Active**].

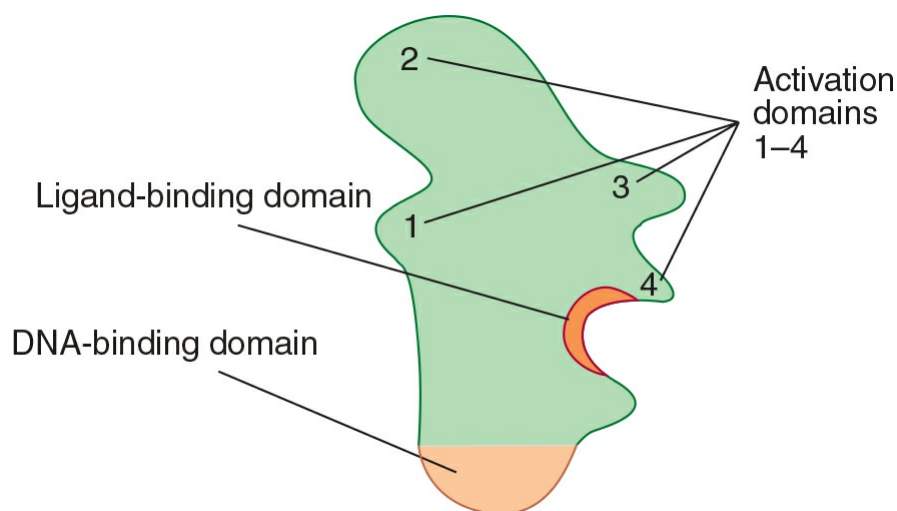

FIGURE 38–19 Proteins that regulate transcription have several domains. This hypothetical transcription factor has a DBD that is distinct from a ligand-binding domain (LBD) and several activation domains (ADs) (1-4). Other proteins may lack the DBD or LBD and all may have variable numbers of domains that contact other proteins, including coregulators and those of the basal transcription complex (see also [Chapters 41](#) and [42](#)).

GENE REGULATION IN PROKARYOTES & EUKARYOTES DIFFERS IN OTHER IMPORTANT RESPECTS

In addition to transcription, eukaryotic cells employ a variety of mechanisms to regulate gene expression (**Table 38–4**). Many more steps, especially in RNA processing, are involved in the expression of eukaryotic genes than of prokaryotic genes, and these steps provide additional sites for regulatory influences that cannot exist in prokaryotes. These RNA processing steps in eukaryotes, described in detail in **Chapter 36**, include capping of the 5' ends of the primary transcripts, addition of a polyadenylate tail to the 3' ends of transcripts, and excision of intron regions to generate spliced exons in the mature mRNA molecule. To date, analyses of eukaryotic gene expression provide evidence that regulation occurs at the level of transcription, nuclear RNA processing, nuclear transport, mRNA stability, and translation. In addition, gene amplification and rearrangement influence gene expression.

TABLE 38–4 Gene Expression Is Regulated by Transcription and in Numerous Other Ways in Eukaryotic Cells

- Gene amplification
- Gene rearrangement
- RNA processing
- Alternate mRNA splicing
- Transport of mRNA from nucleus to cytoplasm
- Regulation of mRNA stability
- Compartmentalization
- ncRNA silencing and activation

Owing to the advent of recombinant DNA technology and high throughput DNA and RNA sequencing and other genetic tools (see **Chapter 39**), much progress has been made in recent years in our understanding of eukaryotic gene expression. However, because most eukaryotic organisms contain so much more genetic information than do prokaryotes and because manipulation of their genes is more difficult, molecular aspects of eukaryotic gene regulation are less well understood than the examples discussed earlier in this chapter. This section briefly describes a few different types of eukaryotic gene regulation.

ncRNAs Modulate Gene Expression by Altering mRNA Function

As noted in [Chapter 35](#), the recently discovered class of ubiquitous large and small eukaryotic non-protein-coding ncRNAs contribute importantly to the control of gene expression. The mechanism of action of the small miRNA and siRNAs are best understood. These ~22 nucleotide RNAs regulate the function/expression of specific mRNAs by either inhibiting translation or inducing mRNA degradation via different mechanisms; in a very few cases miRNAs have been shown to stimulate mRNA function. At least a portion of the miRNA-driven modulation of mRNA activity is thought to occur in the **P body** (see [Figure 37–11](#)). miRNA action can result in dramatic changes in protein production and hence gene expression. These small ncRNAs have been implicated in numerous human diseases such as heart disease, cancer, muscle wasting, viral infection, and diabetes.

miRNAs and siRNAs, like the DNA-binding transcription factors described in detail above, are transactive, and once synthesized and appropriately processed, interact with specific proteins and bind target mRNAs (see [Figure 36–17](#)). Binding of miRNAs to mRNA targets is directed by normal base-pairing rules. In general, if miRNA–mRNA base pairing has one or more mismatches, translation of the cognate “target” mRNA is inhibited, whereas if miRNA–mRNA base pairing is perfect over all 22 nucleotides, the corresponding mRNA is degraded.

Given the tremendous and evergrowing importance of miRNAs, many scientists and biotechnology companies are actively studying miRNA biogenesis, transport, and function in hopes of curing human disease. Time will tell the magnitude and universality of ncRNA-mediated gene regulation.

Eukaryotic Genes Can Be Amplified or Rearranged During Development or in Response to Drugs

During early development of metazoans, there is an abrupt increase in the need for specific molecules such as ribosomal RNA and messenger RNA molecules for proteins that make up specific cell or tissue types. One way to increase the rate at which such molecules can be formed is to increase the number of genes available for transcription of these specific molecules. Among the repetitive DNA sequences within the genome are hundreds of copies of ribosomal RNA genes. These genes preexist repetitively in the

DNA of the gametes and thus are transmitted in high copy numbers from generation to generation. In some specific organisms such as the fruit fly (*Drosophila*), there occurs during oogenesis an amplification of a few preexisting genes such as those for the chorion (eggshell) proteins. Subsequently, these amplified genes, presumably generated by a process of repeated initiations during DNA synthesis, provide multiple sites for gene transcription (Figures 36–4 and 38–20). The dark side of specific gene amplification is the fact that in human cancer cells drug resistance can develop upon extended therapeutic treatment due to the amplification and increased expression of genes that encode proteins that either degrade, or pump drugs from target cells.

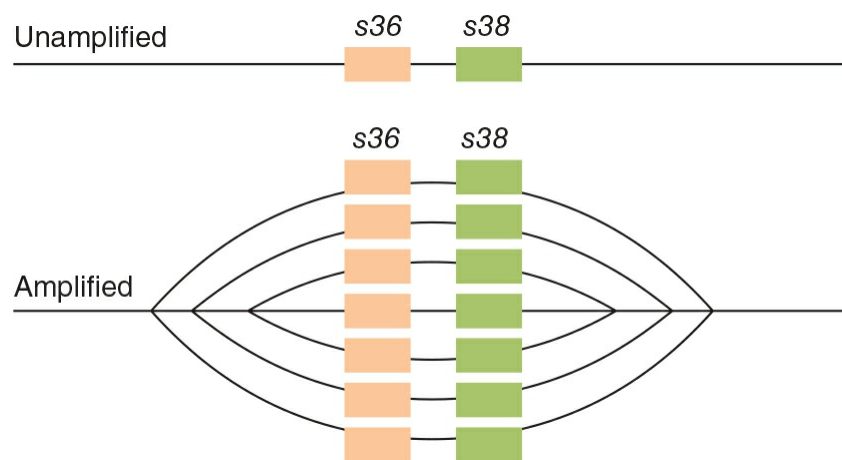

FIGURE 38–20 Schematic representation of the amplification of chorion protein genes *s36* and *s38*. (Reproduced, with permission, from Chisholm R: Gene amplification during development. Trends Biochem Sci 1982;7:161. Copyright © 1982. Reprinted, with permission, from Elsevier.)

As noted in Chapter 36, the coding sequences responsible for the generation of specific protein molecules are frequently not contiguous in the mammalian genome. In the case of antibody encoding genes, this is particularly true. As described in detail in Chapter 52, immunoglobulins are composed of two polypeptides, the so-called heavy (about 50 kDa) and light (about 25 kDa) chains. The mRNAs encoding these two protein subunits are encoded by gene sequences that are subjected to extensive DNA sequence–coding changes. These DNA coding changes are integral to generating the requisite recognition diversity central to appropriate immune function.

IgG heavy- and light-chain mRNAs are encoded by several different segments that are tandemly repeated in the germline. Thus, for example,

the IgG light chain consists of variable (V_L), joining (J_L), and constant (C_L) domains or segments. For particular subsets of IgG light chains, there are roughly 300 tandemly repeated V_L gene coding segments, 5 tandemly arranged J_L coding sequences, and roughly 10 C_L gene coding segments. All of these multiple, distinct coding sequences are located in the same region of the same chromosome, and each type of coding segment (V_L , J_L , and C_L) is tandemly repeated in head-to-tail fashion within the segment repeat region. By having multiple V_L , J_L , and C_L segments to choose from, an immune cell has a greater repertoire of sequences to work with to develop both immunologic flexibility and specificity. However, a given functional IgG light-chain transcription unit—like all other “normal” mammalian transcription units—contains only the coding sequences for a single protein. Thus, before a particular IgG light chain can be expressed, *single* V_L , J_L , and C_L coding sequences must be recombined to generate a *single*, contiguous transcription unit excluding the multiple nonutilized segments (ie, the other approximately 300 unused V_L segments, the other 4 unused J_L segments, and the other 9 unused C_L segments). This deletion of unused genetic information is accomplished by selective DNA recombination that removes the unwanted coding DNA while retaining the required coding sequences: one V_L , one J_L , and one C_L sequence. (V_L sequences are subjected to additional point mutagenesis to generate even more variability—hence the name.) The newly recombined sequences thus form a single transcription unit that is competent for RNA polymerase II-mediated transcription into a single monocistronic mRNA. Although the IgG genes represent one of the best-studied instances of directed DNA rearrangement modulating gene expression, other cases of gene regulatory DNA rearrangement have been described.

Alternative RNA Processing Is Another Control Mechanism

In addition to affecting the efficiency of promoter utilization, eukaryotic cells employ alternative RNA processing to control gene expression. This can result when alternative promoters, intron–exon splice sites, or polyadenylation sites are used. Occasionally, heterogeneity within a cell results, but more commonly the same primary transcript is processed differently in different tissues. A few examples of each of these types of regulation are presented below.

The use of **alternative transcription start sites** results in a different 5' exon on mRNAs encoding mouse amylase and myosin light chain, rat glucokinase, and *Drosophila* alcohol dehydrogenase and actin.

Alternative polyadenylation sites in the μ immunoglobulin heavy-chain primary transcript result in mRNAs that are either 2700 bases long (μ_m) or 2400 bases long (μ_s). This results in a different carboxyl-terminal region of the encoded proteins such that the μ_m protein remains attached to the membrane of the B lymphocyte and the μ_s immunoglobulin is secreted.

Alternative splicing and processing results in the formation of seven unique α -tropomyosin mRNAs in seven different tissues. It is not yet fully understood how these processing-splicing decisions are made or exactly how these steps can be regulated.

Regulation of Messenger RNA Stability Provides Another Control Mechanism

Although most mRNAs in mammalian cells are very stable (half-lives measured in hours), some turn over very rapidly (half-lives of 10-30 minutes). In certain instances, mRNA stability is subject to regulation. This has important implications since there is usually a direct relationship between mRNA amount and the translation of that mRNA into its cognate protein. Changes in the stability of a specific mRNA can therefore have major effects on biologic processes.

Messenger RNAs exist in the cytoplasm as **ribonucleoprotein particles (RNPs)**. Some of these proteins protect the mRNA from digestion by nucleases, while others may under certain conditions promote nuclease attack. It is thought that mRNAs are stabilized or destabilized by the interaction of proteins with these various structures or sequences. Certain effectors, such as hormones, may regulate mRNA stability by increasing or decreasing the amount of these mRNA-binding proteins.

It is known that the ends of mRNA molecules are involved in mRNA stability (**Figure 38–21**). The 5'–cap structure in eukaryotic mRNA prevents attack by 5' exonucleases, and the poly(A) tail prohibits the action of 3' exonucleases. In mRNA molecules with those structures, it is presumed that a single endonucleolytic cut allows exonucleases to attack and digest the entire molecule. Other structures (sequences) in the 5'–untranslated region (5' UTR), the coding region, and the 3' UTR are thought to promote or prevent this initial endonucleolytic action (**Figure 38–21**). Much of this mRNA metabolism likely occurs in cytoplasmic P

bodies.

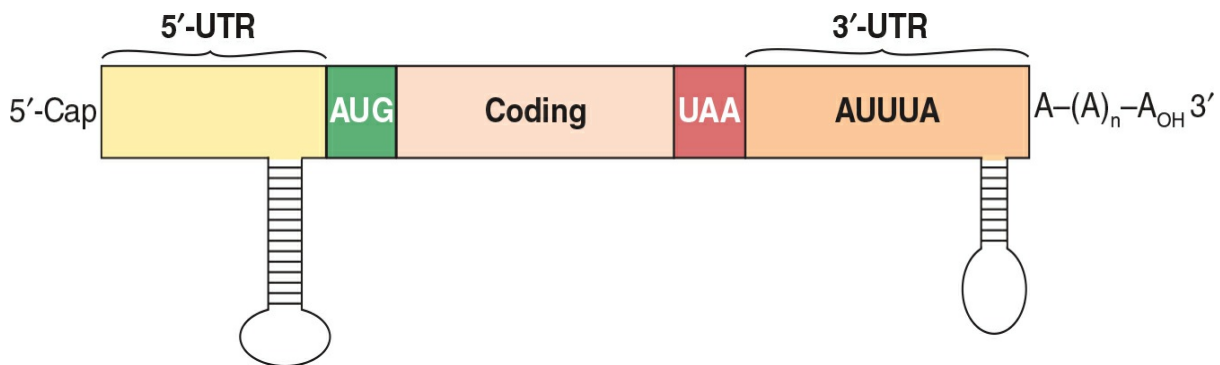

FIGURE 38–21 Structure of a typical eukaryotic mRNA showing elements that are involved in regulating mRNA stability. The typical eukaryotic mRNA has a 5′–noncoding sequence (NCS), or untranslated exonic region (5′ UTR), a coding region, and a 3′–exonic untranslated NCS region (3′ UTR). Essentially all mRNAs are capped at the 5′ end, and most have a 100 to 200 nt polyadenylate sequence at their 3′ end. The 5′ cap and 3′ poly(A) tail protect the mRNA against exonuclease attack and are bound by specific proteins that interact to facilitate translation (see [Figure 37–7](#)). Stem-loop structures in the 5′ and 3′ NCS, and the AU-rich region in the 3′ NCS are thought to represent the binding sites for specific proteins that modulate mRNA stability.

Thus, it is clear that a number of mechanisms are used to regulate mRNA stability and hence function—just as several mechanisms are used to regulate the synthesis of mRNA. Coordinate regulation of these two processes confers on the cell remarkable adaptability.

SUMMARY

- The genetic constitutions of metazoan somatic cells are nearly all identical.
- Phenotype (tissue or cell specificity) is dictated by differences in gene expression of the cellular complement of genes.
- Alterations in gene expression allow a cell to adapt to environmental changes, developmental cues, and physiologic signals.
- Gene expression can be controlled at multiple levels by changes in transcription, mRNA processing, localization, and stability or translation. Gene amplification and rearrangements also influence gene expression.
- Transcription controls operate at the level of protein-DNA and

protein–protein interactions. These interactions display protein domain modularity and high specificity.

- Several different classes of DBD have been identified in transcription factors.
- Chromatin and DNA modifications contribute importantly in eukaryotic transcription control by modulating DNA accessibility and specifying recruitment of specific coactivators and corepressors to target genes.
- Several epigenetic mechanisms for gene control have been described and the molecular mechanisms through which these processes operate are being elucidated at the molecular level.
- ncRNAs modulate gene expression. The short miRNAs and siRNAs modulate mRNA translation and stability.

REFERENCES

- Ambrosi C, Manzo M, Baubec T: Dynamics and context-dependent roles of DNA methylation. *J Mol Biol* 2017;429(10):1459-1475.
- Browning DF, Busby SJ: Local and global regulation of transcription initiation in bacteria. *Nat Rev Microbiol* 2016;14:638-650.
- Dekker J, Mirny L: The 3D genome as moderator of chromosomal communication. *Cell* 2016;164:1110-1121.
- Jacob F, Monod J: Genetic regulatory mechanisms in protein synthesis. *J Mol Biol* 1961;3:318-356.
- Klug A: The discovery of zinc fingers and their applications in gene regulation and genome manipulation. *Annu Rev Biochem* 2010;79:213-231.
- Lemon B, Tjian R: Orchestrated response: a symphony of transcription factors for gene control. *Genes Dev* 2000;14:2551-2569.
- Lee TI, Young RA: Transcriptional regulation and its misregulation in disease *Cell* 2013;152:1237-1251.
- Manning KS, Cooper TA: The roles of RNA processing in translating genotype to phenotype. *Nat Rev Mol Cell Biol* 2017;18:102-114.
- Ptashne M: *A Genetic Switch*, 2nd ed. Cell Press and Blackwell Scientific Publications, 1992.
- Pugh BF: A preoccupied position on nucleosomes. *Nat Struct Mol Biol* 2010;17:923.
- Roeder RG: Transcriptional regulation and the role of diverse coactivators in animal cells. *FEBS Lett* 2005;579:909-915.

Schmitt AM, Chang HY: Long noncoding RNAs in cancer pathways. *Cancer Cell* 2016;29:452-463.

Schwartzman O, Tanay A: Single-cell epigenomics: techniques and emerging applications. *Nat Rev Genet* 2015;16:716-726.

Scotti MM, Swanson MS: RNA mis-splicing in disease. *Nat Rev Genet* 2016;17:19-32.

Small EM, Olson EN: Pervasive roles of microRNAs in cardiovascular biology. *Nature* 2011;469:336-342.

Tee WW, Reinberg D: Chromatin features and the epigenetic regulation of pluripotency states in ESCs. *Development* 2014;141:2376-2390.

Tian B, Manley JL: Alternative polyadenylation of mRNA precursors. *Nat Rev Mol Cell Biol* 2017;18:18-30.

Zaborowska J, Egloff S, Murphy S: The pol II CTD: new twists in the tail. *Nat Struct Mol Biol* 2016;23:771-777.

Zhang, Q Lenardo MJ, Baltimore, D: 30 years of NF- κ B: a blossoming of relevance to human pathobiology. *Cell* 2017;168:37-57.

Molecular Genetics, Recombinant DNA, & Genomic Technology

P. Anthony Weil, PhD

OBJECTIVES

After studying this chapter, you should be able to:

- Understand the basic procedures and methods involved in recombinant DNA technology and genetic engineering.
- Appreciate the rationale behind the methods used to synthesize, analyze, and sequence DNA and RNA.
- Describe how to identify and quantify individual proteins, both soluble and insoluble (ie, membrane bound or compartmentalized intracellularly) proteins, as well as proteins bound to specific sequences of genomic DNA or RNA.

BIOMEDICAL IMPORTANCE*

The development of recombinant DNA techniques, high-density DNA microarrays, high-throughput screening, low-cost genome-scale DNA and RNA sequencing, and other molecular genetic methodologies has

revolutionized biology and is having an increasing impact on clinical medicine. Although much has been learned about human genetic disease from pedigree analysis and study of affected proteins, in many cases where the specific genetic defect is unknown, these approaches cannot be used. The new technologies circumvent these limitations by going directly to cellular DNA and RNA molecules for information. Manipulation of a DNA sequence and the construction of chimeric molecules—so-called genetic engineering—provide a means of studying how a specific segment of DNA controls cellular function. New biochemical and molecular genetic tools allow investigators to query and manipulate genomic sequences as well as to examine the entire complement of cellular RNA, protein, and protein PTM status at the molecular level, even in single cells.

Understanding molecular genetics technology is important for several reasons: (1) it offers a rational approach to understanding the molecular basis of disease. For example, familial hypercholesterolemia, sickle cell disease, the thalassemias, cystic fibrosis, muscular dystrophy as well as more complex multifactorial diseases like vascular and heart disease, Alzheimer disease, cancer, obesity, and diabetes. (2) Human proteins can be produced in abundance for therapy (eg, insulin, growth hormone, tissue plasminogen activator). (3) Proteins for preparation of vaccines (eg, hepatitis B) and for diagnostic testing (eg, Ebola and AIDS tests) can be readily obtained. (4) This technology is used both to diagnose existing diseases as well as to predict the risk of developing a given disease and individual response to pharmacologic therapeutics—so called **personalized medicine**. (5) Special techniques have led to remarkable advances in forensic medicine, which have allowed for the molecular diagnostic analysis of DNA from single cells. (6) Finally, in extremely well understood diseases, potentially curative gene therapy for diseases caused by a single-gene deficiency such as sickle cell disease, the thalassemias, adenosine deaminase deficiency, and others may be devised.

RECOMBINANT DNA TECHNOLOGY INVOLVES ISOLATION & MANIPULATION OF DNA TO MAKE CHIMERIC MOLECULES

Isolation and manipulation of DNA, including end-to-end joining of sequences from very different sources to make chimeric molecules (eg, molecules containing both human and bacterial DNA sequences in a sequence-independent fashion), is the essence of recombinant DNA

research. This involves several unique techniques and reagents.

Restriction Enzymes Cleave DNA Chains at Specific Locations

Certain endonucleases—enzymes that cut DNA at specific DNA sequences within the molecule—(as opposed to exonucleases, which processively digest from the ends of DNA molecules in a primarily sequence-independent fashion)—are a key tool in recombinant DNA research. These enzymes were termed **restriction enzymes**, or **REs**, because their presence in a given bacterium restricted, or prevented the growth of certain bacterial viruses called bacteriophages. Restriction enzymes cut DNA of any source into unique, short pieces in a sequence-specific manner—in contrast to most other enzymatic, chemical, or physical methods, which break DNA randomly. These defensive enzymes (hundreds have been discovered) protect the host bacterial DNA from the DNA genome of foreign organisms (primarily infective phages) by specifically inactivating the invading phage DNA by digestion. The viral RNA-inducible interferon system (see [Chapter 38](#); [Figure 38–11](#)) provides the same sort of molecular defense against RNA viruses in mammalian cells. However, restriction endonucleases are present only in cells that also have a companion enzyme that site-specifically methylates the DNA of the bacterial host, thereby rendering it noncleavable by that particular restriction enzyme. Thus, sequence-specific DNA methylases and sequence-specific restriction endonucleases that target the exact same sites always exist in pairs in a given bacterium.

Restriction enzymes are named after the bacterium from which they are isolated. For example, *EcoRI* is from *Escherichia coli*, and *BamHI* is from *Bacillus amyloliquefaciens* ([Table 39–1](#)). The first three letters in the restriction enzyme name consist of the first letter of the genus (*E*) and the first two letters of the species (*co*) in the case of the restriction enzyme *EcoRI* derived from *E. coli* strain R. These designations may be followed by a strain designation (*R*) and a roman numeral (*I*) to indicate the order of discovery (eg, *EcoRI* and *EcoRII*). Each enzyme recognizes and cleaves a specific double-stranded DNA sequence that is typically 4- to 8-bp long. These DNA cuts result in **blunt ends** (eg, *HpaI*) or overlapping (**sticky or cohesive**) ends (eg, *BamHI*) ([Figure 39–1](#)), depending on the mechanism used by the enzyme. Sticky ends are particularly useful in constructing hybrid or chimeric DNA molecules (see below). If the four nucleotides are distributed randomly in a given DNA

molecule, one can calculate how frequently a given enzyme will cut a length of DNA. For each position in the DNA molecule, there are four possibilities (A, C, G, and T); therefore, a restriction enzyme that recognizes a 4-bp sequence cuts DNA, on average, once every 256 bp (4^4), whereas another enzyme that recognizes a 6-bp sequence cuts once every 4096 bp (4^6). A given piece of DNA has a characteristic linear array of sites for the various enzymes dictated by the linear sequence of its bases; hence, a **restriction map** can be constructed. When DNA is digested with a particular enzyme, the ends of all the fragments have the same DNA sequence. The fragments produced can be isolated by electrophoresis on agarose or polyacrylamide gels (see the discussion of blot transfer, below); this is an essential step in DNA cloning as well as various DNA analyses, and a major use of these enzymes.

TABLE 39–1 Selected Restriction Endonucleases and Their Sequence Specificities

Endonuclease	Sequence Recognized Cleavage Sites Shown	Bacterial Source
<i>BamHI</i>	↓ G GATCC CCTAC C ↑	<i>Bacillus amyloliquefaciens H</i>
<i>BglII</i>	↓ A GATCT TCTAG A ↑	<i>Bacillus globigii</i>
<i>EcoRI</i>	↓ G AATTC CTTAA C ↑	<i>Escherichia coli RY13</i>
<i>EcoRII</i>	↓ CCTGG GGACC ↑	<i>Escherichia coli R245</i>
<i>HindIII</i>	↓ A AGCTT TTCGA A ↑	<i>Haemophilus influenzae R_d</i>
<i>HhaI</i>	↓ GCG C C GCG ↑	<i>Haemophilus haemolyticus</i>
<i>HpaI</i>	↓ GTT AAC CAA TTC ↑	<i>Haemophilus Parainfluenza</i>
<i>MstII</i>	↓ CC TnAGG GGAnT CC ↑	<i>Microcoleus strain</i>
<i>PstI</i>	↓ CTGCA G G ACGTC ↑	<i>Providencia stuartii</i> 164
<i>TaqI</i>	↓ T CGA AGC T ↑	<i>Thermus aquaticus</i> YTI

Abbreviations: A, adenine; C, cytosine; G, guanine; T, thymine. Arrows show the site of cleavage; depending on the site, the ends of the resulting cleaved double-stranded DNA are termed sticky ends (*BamHI*) or blunt ends (*HpaI*). The length of the recognition sequence can be 4 bp (*TaqI*), 5 bp (*EcoRII*), 6 bp (*EcoRI*), or 7 bp (*MstII*) or longer. By convention, these are written in the 5' to 3' direction for the upper strand of each recognition sequence, and the lower strand is shown with the opposite (ie, 3'-5') polarity. Note that most recognition sequences are palindromes (ie, the sequence reads the same in opposite directions on the two strands). A residue designated n means that any nucleotide is permitted.

A. Sticky or staggered ends

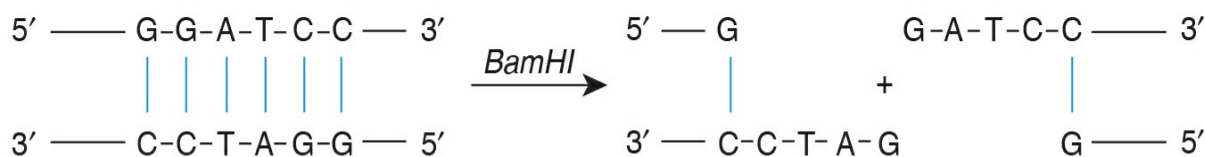

B. Blunt ends

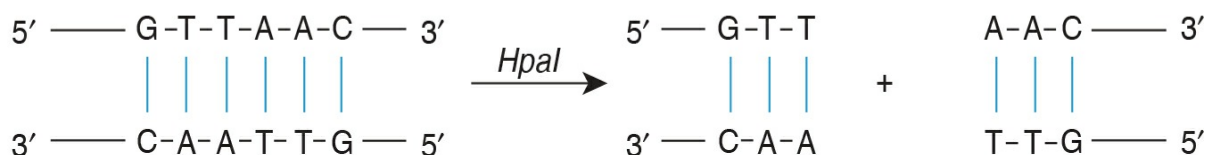

FIGURE 39–1 Results of restriction endonuclease digestion. Digestion with a restriction endonuclease can result in the formation of DNA fragments with sticky, or cohesive, ends (**A**), or blunt ends (**B**); phosphodiester backbone, black lines; interstrand hydrogen bonds between purine and pyrimidine bases, blue. Generating fragments whose ends have particular structures (ie, blunt, cohesive) is an important consideration in devising cloning strategies.

A number of other enzymes that act on DNA and RNA are an important part of recombinant DNA technology. Many of these are referred to in this and subsequent chapters (**Table 39–2**).

TABLE 39–2 Some of the Enzymes Used in Recombinant DNA Research

Enzyme	Reaction	Primary Use
Phosphatases	Dephosphorylates 5' ends of RNA and DNA	Removal of 5'-PO ₄ groups prior to kinase labeling; also used to prevent self-ligation
DNA ligase	Catalyzes bonds between DNA molecules	Joining of DNA molecules
DNA polymerase I	Synthesizes double-stranded DNA from single-stranded DNA	Synthesis of double-stranded cDNA; DNA labeling and nick translation; generation of blunt ends from sticky ends
Thermostable DNA polymerases	Synthesize DNA at elevated temperatures (60-80°C)	Polymerase chain reaction (DNA synthesis), mutagenesis
DNase I	Under appropriate conditions, produces single-stranded nicks in DNA	Nick translation; mapping of hypersensitive sites; mapping protein-DNA interactions
Exonuclease III	Removes nucleotides from 3' ends of DNA	DNA sequencing; ChIP-Exo, mapping of DNA-protein interactions
λ Exonuclease	Removes nucleotides from 5' ends of DNA	DNA sequencing, mapping of DNA-protein interactions
Polynucleotide kinase	Transfers terminal phosphate (γ position) from ATP to 5'-OH groups of DNA or RNA	³² P end-labeling of DNA or RNA
Reverse transcriptase	Synthesizes DNA from RNA template	Synthesis of cDNA from mRNA; RNA (5' end) mapping studies
RNase H	Degrades the RNA portion of a DNA-RNA hybrid	Synthesis of cDNA from mRNA
S1 nuclease	Degrades single-stranded DNA	Removal of "hairpin" in synthesis of cDNA; RNA mapping studies (both 5' and 3' ends)
Terminal transferase	Adds nucleotides to the 3' ends of DNA	Homopolymer tailing
Recombinases (CRE, INT, FLP)	Catalyze site-specific recombination between DNA containing homologous target sequences	Generation of specific chimeric DNA molecules, work both in vitro and in vivo
CRISPER-Cas9/C2c2	RNA-targeted DNA-, or RNA-directed nuclease	Genome editing and with variations modulation of gene expression at DNA and RNA levels

Restriction Enzymes, Endonucleases, Recombinases, & DNA Ligase Are Used to Engineer and Prepare Chimeric DNA Molecules

Sticky, or complementary cohesive-end ligation of DNA fragments is technically easy, but some special techniques are often required to overcome problems inherent in this approach. Sticky ends of a vector may reconnect with themselves, with no net gain of DNA. Sticky ends of fragments also anneal so that heterogeneous tandem inserts can form.

Also, sticky-end sites may not be available or in a convenient position. To alleviate these problems, an enzyme that generates blunt ends can be used. Blunt ends can be ligated directly; however, ligation is not directional. To circumvent this problem new DNA ends of specific sequence can be added to by direct blunt-end ligation using the bacteriophage T4 enzyme DNA ligase. Alternatively, convenient RE recognition sites can be added to a DNA fragment through the use of polymerase chain reaction (PCR) amplification (see below).

As an adjunct to the use of restriction endonucleases to combine and engineer DNA fragments, scientists have begun utilizing recombinases such as bacterial lox P sites, which are recognized by the CRE recombinase, bacteriophage λ att sites recognized by the λ phage encoded INT protein or yeast FRT sites recognized by the yeast F1p recombinase. These recombinase systems all catalyze specific incorporation of two DNA fragments that carry the appropriate recognition sequences and carry out homologous recombination (see [Figure 35–9](#)) between the relevant recognition sites. A novel DNA editing/gene regulatory system termed **CRISPR-Cas9** (clustered regularly interspersed short palindromic repeats–associated gene **9**) first discovered in 2012, has revolutionized genomic DNA studies. The CRISPR system, found in many bacteria, represents a form of acquired, or adaptive immunity (see [Chapters 52, 54](#)) to prevent reinfection of a bacterium by specific bacteriophages. CRISPR complements the system of restriction endonucleases and methylases described above. CRISPR uses RNA-based targeting to bring the Cas9 nuclease to foreign (or any complementary) DNA. Within bacteria this CRISPR-RNA-Cas9 complex then degrades and inactivates the targeted DNA. The CRISPR system has been adapted for use in eukaryotic cells, including human cells, where it has been shown to be an RNA-directed site-specific nuclease just as it is in bacteria. Variations on the use of CRISPR allow for gene deletion, gene editing, gene visualization, and even modulation of gene transcription. Thus, CRISPR has added an exciting new, highly efficient, and very specific technology to the toolbox of methods for the manipulation of DNA and genetic analysis of mammalian cells. The basic aspects of CRISPR-Cas9 function are outlined in [Figure 39–2](#).

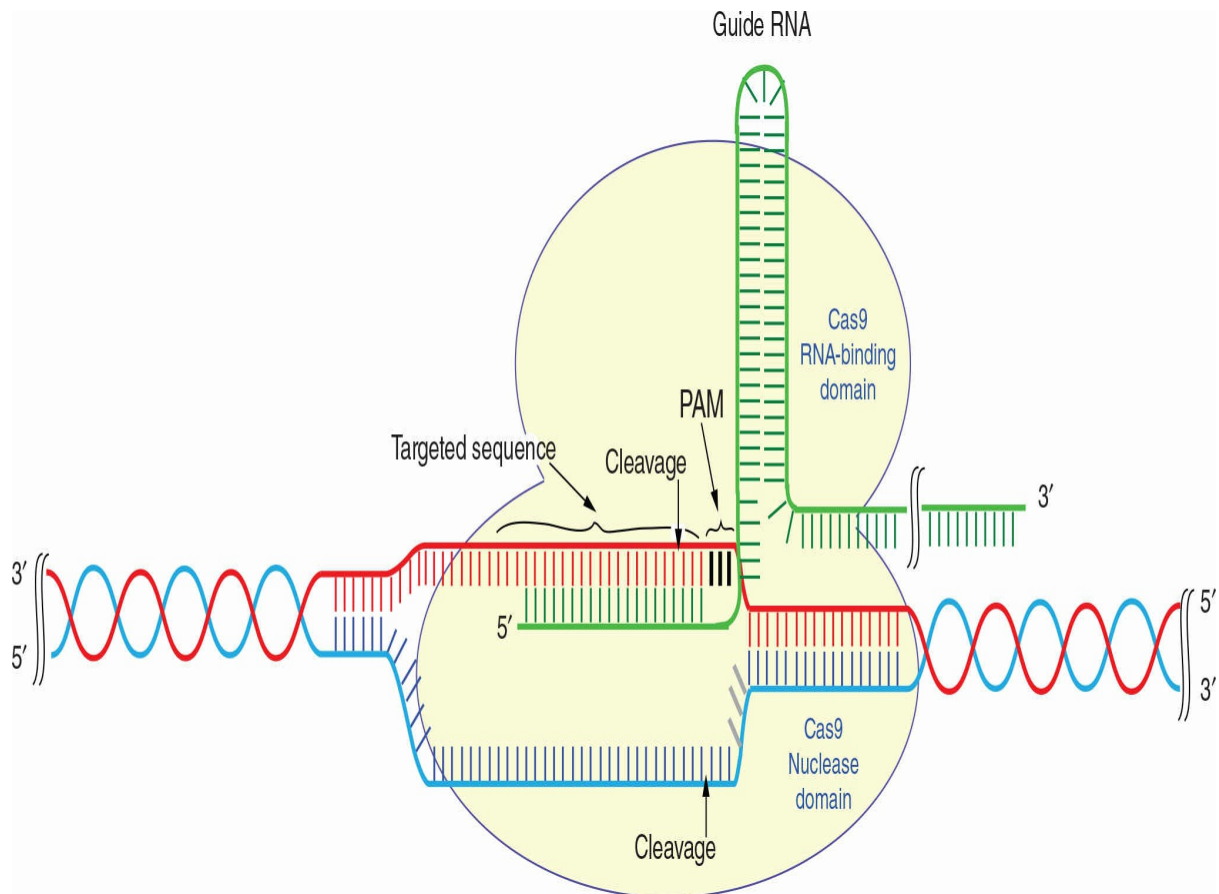

FIGURE 39–2 Overview of the mechanism of CRISPR-Cas9. Shown is the two-domain CRISPR-Cas9 nuclease protein bound to target genomic DNA (red, blue) and specific guide RNA (green), which through base complementarity (20 nts) locates its genomic target, which is adjacent to a short protospacer adjacent motif, or PAM. The guide RNA binding, and nuclease domains are labeled. Once specifically localized, the two distinct Cas9 nuclease active centers cleave both strands of the targeted genomic DNA (cleavage; arrows) immediately downstream of the PAM, which results in DNA double-strand break. Subsequent DNA repair by cellular activities (see [Chapter 35](#)) can introduce mutations thereby inactivating the targeted gene. Variations on the use of CRISPR-Cas9 are numerous and allow for the sculpting of the structure and expression of genomic DNA.

The similarities of the CRISPR-Cas RNA-directed targeting and gene inactivation method and mi/siRNA-mediated repression of expression in higher eukaryotes are notable. Both methodologies are being actively pursued for experimental and therapeutic purposes. Interestingly, a variant of the CRISPR-Cas system, C2c2, has been shown to site-specifically cleave RNA. This exciting discovery paves the way for potential specific

alteration of mRNA/ncRNA levels in human cells absent the ethical and technical challenges inherent in genome editing with the CRISPR-Cas9 system.

Cloning Amplifies DNA

A **clone** is a large population of identical molecules, cells, or organisms that arise from a common ancestor. Molecular cloning allows for the production of a large number of identical DNA molecules, which can then be characterized or used for other purposes. This technique is based on the fact that chimeric or hybrid DNA molecules can be constructed in **cloning vectors**—typically bacterial plasmids, phages, or cosmids (hybrid plasmids that also contain specific phage sequences)—which then continue to replicate clonally in a single host cell under their own control systems. In this way, the chimeric DNA is amplified. The general procedure is illustrated in **Figure 39–3**.

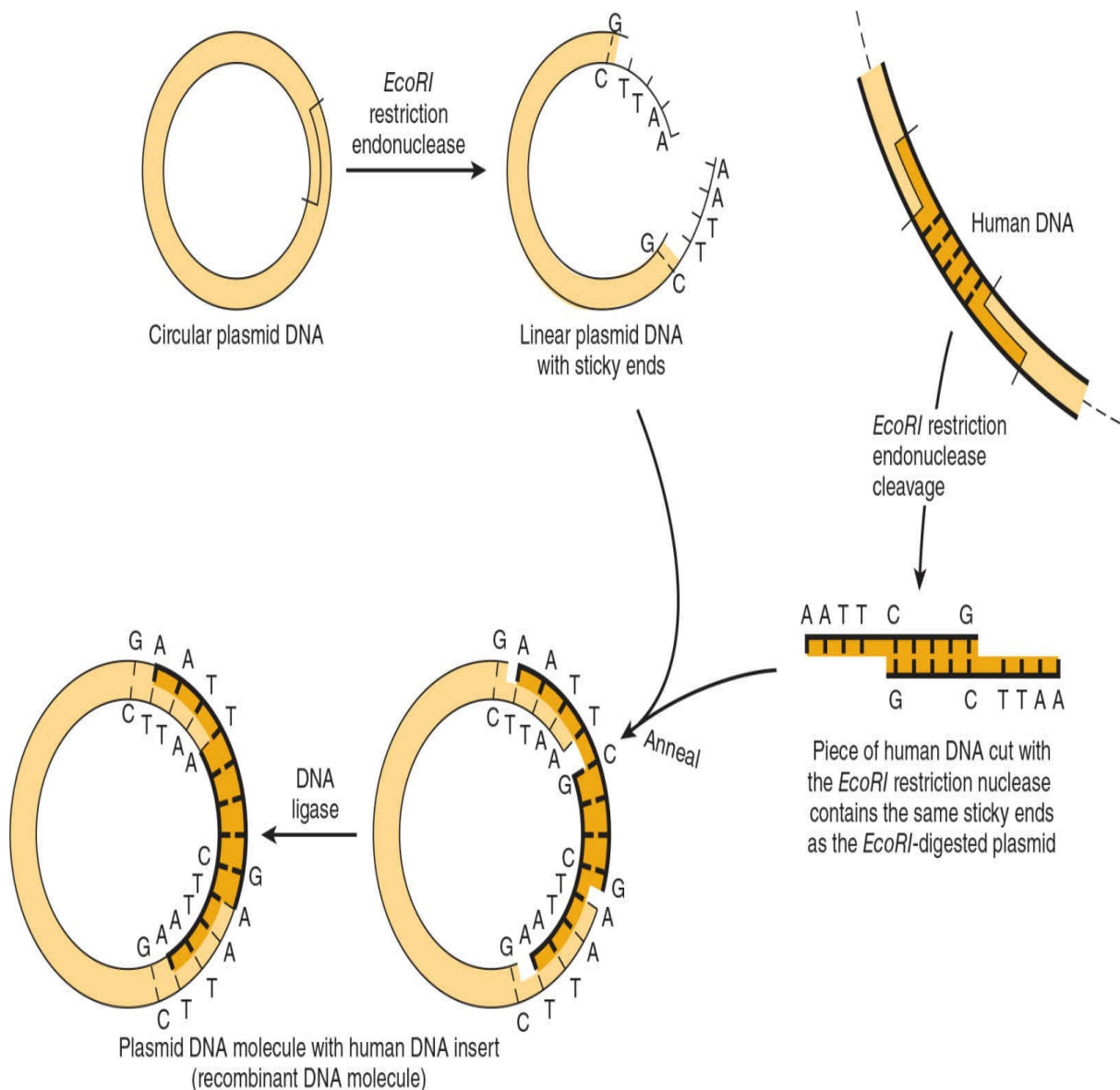

FIGURE 39–3 Use of restriction endonucleases to make new recombinant or chimeric DNA molecules. When inserted back into a bacterial cell (by the process called DNA-mediated transformation), typically only a single plasmid is taken up by a single cell, and the plasmid DNA replicates clonally, not only itself, but also the physically linked new DNA insert. Since recombining the sticky ends, as indicated, typically regenerates the same DNA sequence recognized by the original restriction enzyme, the cloned DNA insert can be cleanly cut back out of the recombinant plasmid circle with this endonuclease. Alternatively, the insert sequences can be specifically amplified from the purified chimeric plasmid DNA by PCR (Figure 39–7). If a mixture of all of the DNA pieces created by treatment of total human DNA with a single restriction nuclease is used as the source of human DNA, a million or so different types of recombinant DNA molecules can be obtained, each pure in its own

bacterial clone. (Modified and reproduced, with permission, from Cohen SN: The manipulation of genes. Sci Am [July] 1975;233:25. Copyright © The Estate of Bunji Tagawa.)

Bacterial **plasmids** are small, circular, duplex DNA molecules whose natural function is to confer antibiotic resistance to the host cell. Plasmids have several properties that make them extremely useful as cloning vectors. They exist as single or multiple copies within the bacterium and replicate independently from the bacterial DNA as **episomes** (ie, a genome above or outside the bacterial genome) while using primarily the host replication machinery. The complete DNA sequence of thousands of plasmids is known; hence, the precise location of restriction enzyme cleavage sites for inserting the foreign DNA is available. Plasmids are smaller than the host chromosome and are therefore easily biochemically separated from the latter, and the desired plasmid-inserted DNA can be readily removed by cutting the plasmid with the enzyme specific for the restriction site into which the original piece of DNA was inserted.

Phages (bacterial viruses) often have linear DNA genomes into which foreign DNA can be inserted at unique restriction enzyme sites. The resulting chimeric DNA is collected after the phage proceeds through its lytic cycle and produces mature, infective phage particles. A major advantage of phage vectors is that while plasmids accept DNA pieces up to about 10-kb long, phages can readily accept DNA fragments up to ~20-kb long. The ultimate insert size is imposed by the amount of DNA that can be packed into the phage head during virus propagation.

Larger fragments of DNA can be cloned in **cosmids**, DNA cloning vectors that combine the best features of plasmids and phages. Cosmids are plasmids that contain the DNA sequences, so-called **cos sites**, required for packaging lambda DNA into the phage particle. These vectors grow in the plasmid form in bacteria, but since much of the unnecessary lambda DNA has been removed, more chimeric DNA can be packaged into the particle head. Cosmids can carry inserts of chimeric DNA that are 35- to 50-kb long. Even larger pieces of DNA can be incorporated into bacterial artificial chromosome (**BAC**), yeast artificial chromosome (**YAC**), or *E. coli* bacteriophage P1-derived artificial chromosome (**PAC**) vectors. These vectors will accept and propagate DNA inserts of several hundred kilobases or more, and have largely replaced the plasmid, phage, and cosmid vectors for some cloning and eukaryotic gene mapping/expression applications. A comparison of these vectors is shown in **Table 39–3**.

TABLE 39–3 Cloning Capacities of Common Cloning Vectors

Vector	DNA Insert Size (kb)
Plasmid pUC19	0.01-10
Lambda charon 4A	10-20
Cosmids	35-50
BAC, P1	50-250
YAC	500-3000

Because insertion of DNA into a functional region of the vector will interfere with the action of this region, care must be taken not to interrupt an essential function of the vector. This concept can be exploited, however, to provide a powerful double positive/negative selection technique. For example, a common early plasmid vector **pBR322** has genes conferring resistance to both **tetracycline (Tet)** and **ampicillin (Amp)**, that is, **Tetr**-and **Ampr**-resistant growth, respectively. A single *PstI* restriction enzyme site within the Amp resistance gene is commonly used as the insertion site for a piece of foreign DNA. In addition to having sticky ends (Table 39–1 and Figure 39–1), the DNA inserted at this site disrupts the ORF of the β -lactamase-encoding *bla* gene. β -lactamase, a secreted enzyme degrades and inactivates ampicillin. A bacterium carrying such a plasmid will be Amp-sensitive (Amp^S). Thus, cells carrying the parental plasmid, which provides resistance to both antibiotics, can be readily distinguished, and separated from cells carrying the chimeric plasmid, which is resistant only to tetracycline (Figure 39–4). YACs contain selection, replication, and segregation functions that work in both bacteria and yeast cells and therefore can be propagated in either organism.

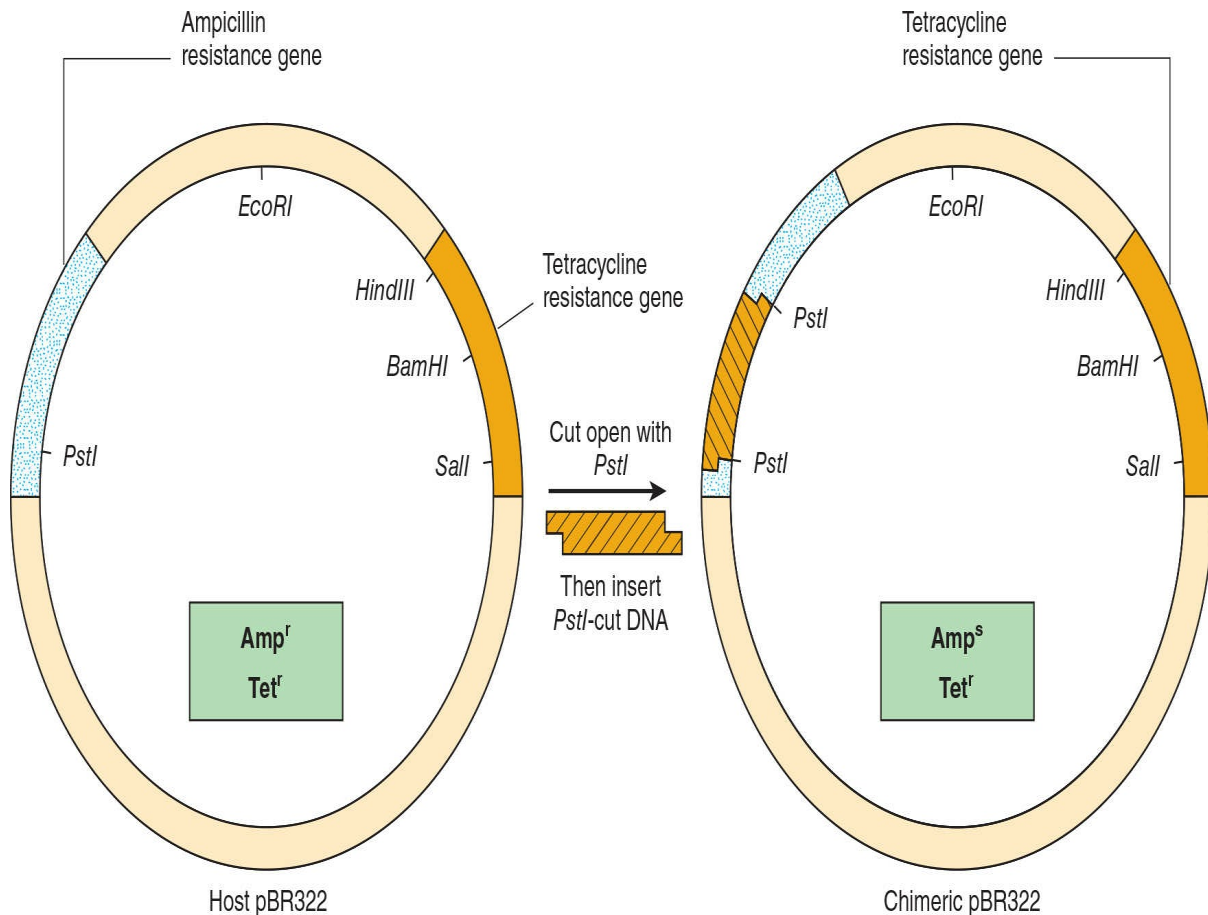

FIGURE 39–4 A method of screening recombinants for inserted DNA fragments. Using the plasmid pBR322, a piece of DNA is inserted into the unique *PstI* site. This insertion disrupts the codon reading frame for the gene coding for a protein that provides ampicillin resistance to the host bacterium. Hence, cells carrying the chimeric plasmid will no longer grow/survive when cultured in liquid, or plated on a substrate medium that contains this antibiotic. The differential sensitivity to tetracycline and ampicillin can therefore be used to distinguish clones of plasmid that contain an insert. A similar scheme relying on production of an in-frame fusion of a newly inserted DNA producing a peptide fragment capable of complementing an inactive, N-terminally truncated form of the enzyme β -galactosidase, a component of the *lac* operon (see [Figure 38–2](#)) allows for blue-white colony formation on agar plates containing a dye hydrolyzable by β -galactosidase. β -galactosidase–positive colonies are blue; such colonies contain plasmids in which a DNA was successfully inserted.

In addition to the vectors described in [Table 39–3](#) that are designed primarily for propagation in bacterial cells, vectors for mammalian cell propagation and insert gene (cDNA)/protein expression have also been developed. These vectors are all based on various eukaryotic viruses that

are composed of RNA or DNA genomes. Notable examples of such **viral vectors** are those utilizing **adenoviral (Ad)**, or **adenovirus-associated viral (AAV)** (DNA-based) and **retroviral** (RNA based) genomes. Though somewhat limited in the size of DNA sequences that can be inserted, such **mammalian viral cloning vectors** make up for this shortcoming because they will efficiently infect a wide range of different cell types. For this reason, various mammalian viral vectors, some with both positive and negative selection genes (*aka* selectable “markers” as noted above for pBR322) are being investigated for use in **gene therapy** and are commonly used for laboratory experiments.

A Library Is a Collection of Recombinant Clones

The combination of restriction enzymes and various cloning vectors allows the entire genome of an organism to be individually packed, in small segments, into a vector. A collection of these different recombinant clones is called a library. A **genomic library** is prepared from the total DNA of a cell line or tissue that has been fragmented using either restriction endonucleases, or shearing and adaptor ligation to the resulting fragments. A **cDNA library** comprises complementary DNA copies of the population of mRNAs in a tissue. Genomic DNA libraries are often prepared by performing **partial digestion of total DNA** with a restriction enzyme that cuts DNA frequently (eg, a four-base cutter such as *TaqI*). The idea is to generate rather large fragments so that most genes will be left intact. The BAC, YAC, and P1 vectors are preferred since they can accept very large fragments of DNA and thus offer a better chance of isolating an intact eukaryotic mRNA-encoding gene on a single DNA fragment.

A vector in which the protein coded by the gene introduced by recombinant DNA technology is actually synthesized is known as an **expression vector**. Such vectors are now commonly used to detect specific cDNA molecules in libraries and to produce proteins by genetic engineering techniques. These vectors are specially constructed to contain very active inducible promoters, proper in-phase translation initiation codons, transcription and translation termination signals, and appropriate protein processing signals, if needed. Some expression vectors even contain genes that code for protease inhibitors, so that the final yield of product is enhanced. Interestingly, as the cost of synthetic DNA synthesis has dropped, many investigators now often simply synthesize an entire cDNA (gene) of interest (in 100–150 nt segments) incorporating the codon preferences of the host used for expression in order to maximize protein

production. New efficiencies in synthetic DNA synthesis now allow for the de novo synthesis of complete genes and even genomes. These advances usher in new and exciting possibilities in synthetic biology while concomitantly introducing potential ethical conundrums.

Probes Search Libraries or Complex Samples for Specific Genes or cDNA Molecules

A variety of molecules can be used to “probe” libraries in search of a specific gene or cDNA molecule or to define and quantitate DNA or RNA separated by electrophoresis through various gels. Probes are generally pieces of DNA or RNA labeled with a ^{32}P -containing nucleotide—or fluorescently labeled nucleotide(s) (more commonly now). Importantly, neither modification (^{32}P or fluorescent-label) affects the hybridization properties of the resulting labeled nucleic acid probes. The probe must recognize a complementary sequence to be effective. A cDNA synthesized from a specific mRNA (or a synthetic oligonucleotide) can be used to screen either a cDNA library for a longer cDNA or a genomic library for a complementary sequence in the coding region of a gene.

cDNA/oligonucleotide/cRNA probes are used to detect DNA fragments on Southern blot transfers and to detect and quantitate RNA on Northern blot transfers (see below).

Blotting & Probing Techniques Allow Visualization of Specific Target Molecules

Visualization of a specific DNA or RNA fragment (or protein, see below) among the many thousands of “contaminating” nontarget molecules in a complex sample requires the convergence of a number of techniques, collectively termed **blot transfer**. **Figure 39–5** illustrates the **Southern** (DNA), **Northern** (RNA), and **Western** (protein) blot transfer procedures. The first technique is named for the person who devised the technique, Edward Southern; the other names began as laboratory jargon, but are now accepted terms. These procedures are useful in determining how many copies of a gene are in a given tissue or whether there are any alterations in a gene (deletions, insertions, or rearrangements) because the requisite, initial gel electrophoresis step separates the molecules on the basis of size. Occasionally, if a specific base is changed and a restriction site is altered, these procedures can detect a point mutation (ie, **Figure 39–9** below). The Northern and Western blot transfer techniques are used to size and

quantify specific RNA and protein molecules, respectively. A fourth technique, the **Southwestern** or **overlay blot**, which examines protein–nucleic acid interactions or protein–protein interactions, respectively are variants of the Southern/Northern/Western blotting methods (not shown). In these last two techniques, proteins are separated by electrophoresis, blotted to a membrane, renatured, and analyzed for an interaction with a particular DNA or RNA sequence or protein by incubation with a specific labeled nucleic acid probe (Southwestern) or protein probe (overlay assay) using either a labeled protein, or alternatively protein–protein interactions are detected using a specific antibody.

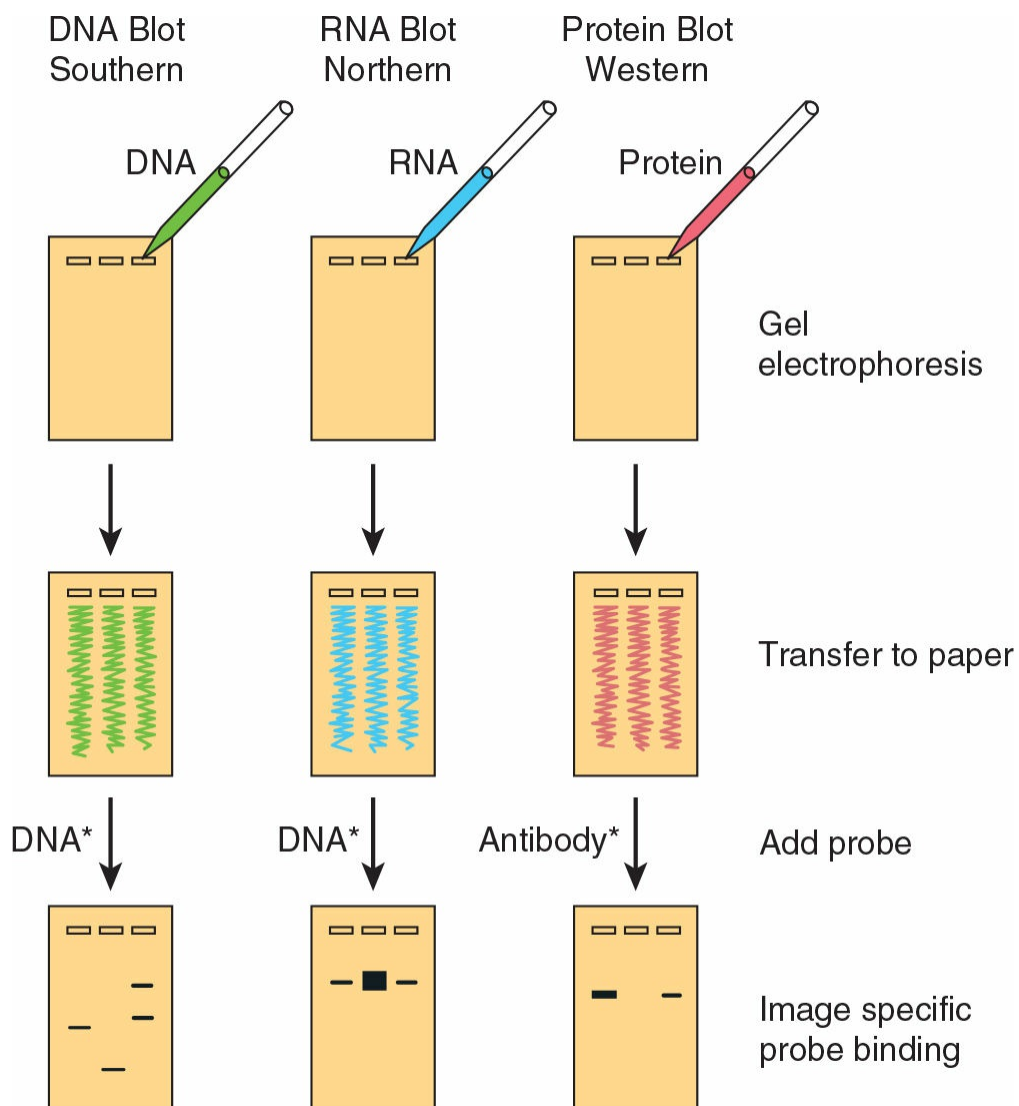

FIGURE 39–5 The blot transfer procedure. In a Southern, or DNA blot transfer, DNA isolated from a cell line or tissue is digested with one or more restriction enzymes. This mixture is pipetted into a well in an agarose or polyacrylamide gel and exposed to a direct electrical current.

DNA, being negatively charged, migrates toward the anode; the smaller fragments move the most rapidly. After a suitable time, the DNA within the gel is denatured by exposure to mild alkali and transferred, via capillary action (or electrotransfer—not shown), to nitrocellulose or nylon paper, resulting in an exact replica of the pattern on the gel, using the blotting technique devised by Southern blot. The DNA is bound to the paper by exposure to heat or UV, and the paper is then exposed to the labeled DNA probe, which hybridizes to complementary strands on the filter. After thorough washing, the paper is exposed to x-ray film or an imaging screen, which is developed to reveal several specific bands corresponding to the DNA fragment(s) that were recognized (hybridized to) the sequences in the DNA probe. The RNA, or Northern, blot is conceptually similar. RNA is subjected to electrophoresis before blot transfer. This requires some different steps from those of DNA transfer, primarily to ensure that the RNA remains intact, and is generally somewhat more difficult. In the protein, or Western, blot, proteins are electrophoresed and transferred to special paper that avidly binds proteins and then probed with a specific antibody or other probe molecule. (Asterisks signify labeled probes, either radioactive or fluorescent.) In the case of Southwestern blotting (see the text; not shown), a protein blot similar to that shown above under “Western” is exposed to labeled nucleic acid, and protein–nucleic acid complexes formed are detected by autoradiography or imaging.

All of the nucleic acid–based hybridization procedures discussed in this section depend on the specific base-pairing properties of complementary nucleic acid strands (see [Chapter 34](#)). Perfect matches hybridize readily and withstand high temperatures and/or low ionic strength buffer in the hybridization and washing reactions. Less than perfect matches do not tolerate such **stringent conditions** (ie, elevated temperatures and low-salt concentrations); thus, hybridization either never occurs or is disrupted during the washing step. Hybridization conditions capable of detecting just a single base-pair (bp) mismatch between probe and target have been devised.

Manual & Automated Techniques Are Available to Determine the Sequence of DNA

The segments of specific DNA molecules obtained by recombinant DNA technology can be analyzed to determine their nucleotide sequence. DNA

sequencing depends on having a population of identical DNA molecules. This requirement can be satisfied by cloning the fragment of interest, either using the techniques described above, or by using PCR methods (see below). The **manual enzymatic Sanger method** employs specific dideoxynucleotides that terminate DNA strand synthesis at specific nucleotides as the strand is synthesized on purified single-stranded template DNA. The reactions are adjusted so that a population of DNA fragments representing termination at every nucleotide is obtained. By having a radioactive label incorporated at the termination site, one can separate the fragments according to size using polyacrylamide gel electrophoresis. An autoradiograph is made, and each of the fragments produces an image (band) on an x-ray film or imaging plate. These are read in order to give the DNA sequence (**Figure 39–6**). Techniques that do not require the use of radioisotopes are employed in automated DNA sequencing. Most commonly employed is an automated procedure in which four different fluorescent labels, one representing each nucleotide, are used. Each emits a specific signal upon excitation by a laser beam of a particular wavelength that is measured by sensitive detectors, and these signals can be recorded by a computer. The newest DNA sequencing machines use fluorescently labeled nucleotides but detect incorporation using microscopic optics. These machines have reduced the cost of DNA sequencing by orders of magnitude. These reductions in cost have ushered in the era of personalized genome sequencing. Indeed, using this new technology, the genome sequence of the codiscoverer of the double helix, James Watson, was completely determined.

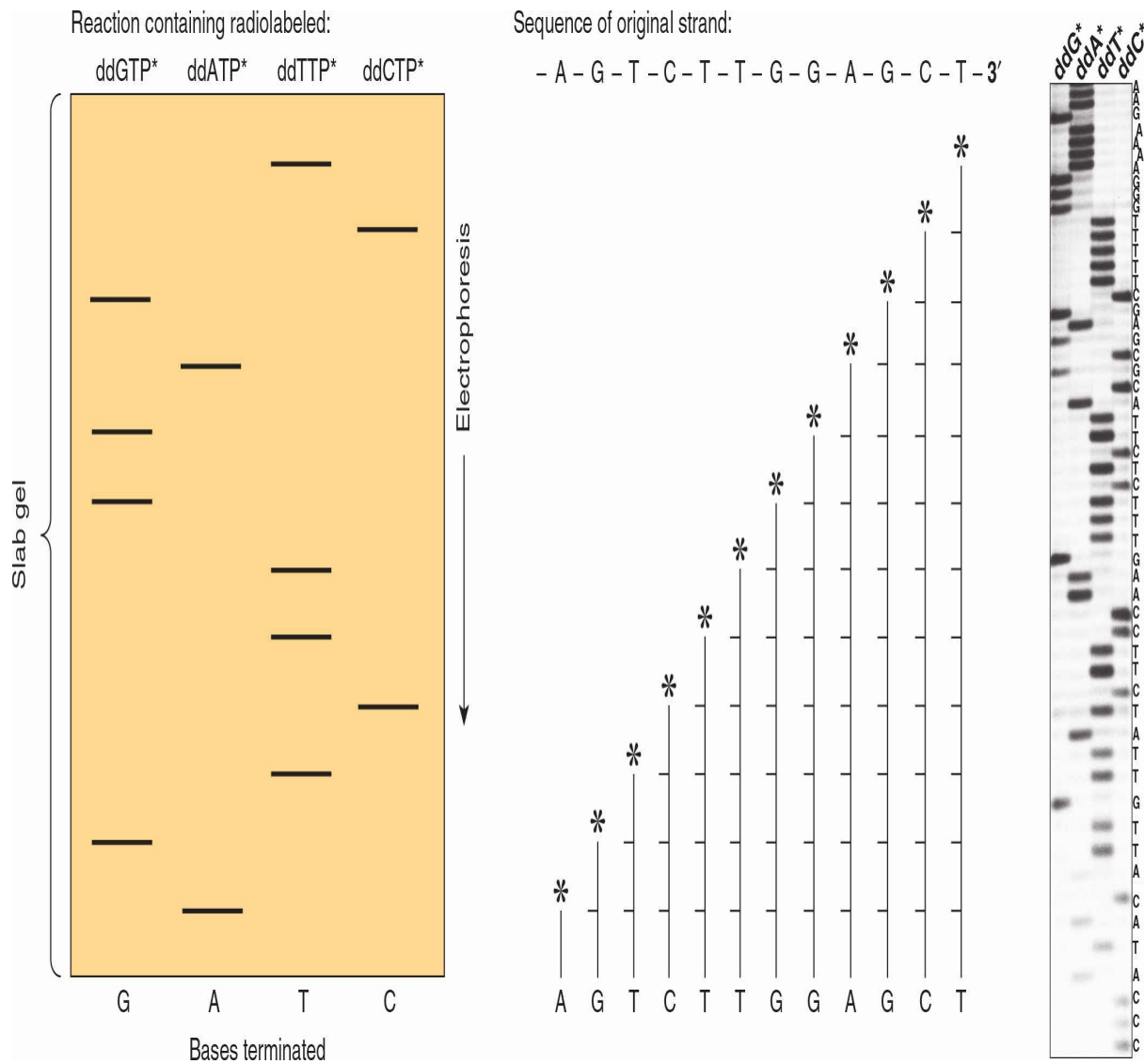

FIGURE 39–6 Sequencing of DNA by the chain termination method devised by Sanger. The ladder-like arrays represent, from bottom to top, all of the successively longer fragments of the original DNA strand. Knowing which specific dideoxynucleotide reaction was conducted to produce each mixture of fragments, one can determine the sequence of nucleotides from the unlabeled end toward the labeled end (*) by reading up the gel. The base-pairing rules of Watson and Crick (A–T, G–C) dictate the sequence of the other (complementary) strand. (Asterisks signify site of radiolabeling.) Schematically shown (**left, middle**) are the terminated synthesis products of a hypothetical fragment of DNA, sequence listed (**middle, top**). An autoradiogram (**right**) of an actual set of DNA sequencing reactions that utilized the four ^{32}P -labeled dideoxynucleotides indicated at the top of the scanned autoradiogram (ie, dideoxy(dd)G, ddA, ddT, ddC). Electrophoresis was from top to bottom. The deduced DNA sequence is listed on the right side of the gel. Note the log-linear

relationship between distance of migration (ie, top to bottom of gel) and DNA fragment length. Current state-of-the-art DNA sequencers no longer utilize gel electrophoresis for fractionation of labeled synthesis products. Moreover, in the majority of NGS sequencing platforms, synthesis is followed by monitoring incorporation of the four fluorescently labeled dXTPs.

Oligonucleotide Synthesis Is Now Routine

Automated chemical synthesis of moderately long oligonucleotides (~100 nucleotides) of precise sequence is now a routine laboratory procedure. Each synthetic cycle takes but minutes such that very large DNA molecules can be made by synthesizing relatively short segments that are then be ligated to one another. As mentioned above for DNA sequencing, the process has been miniaturized and can be significantly parallelized to allow the synthesis of hundreds to thousands of defined sequence oligonucleotides simultaneously. Oligonucleotides are now indispensable for DNA sequencing, library screening, protein-DNA binding assays, the PCR (see below), site-directed mutagenesis, complete synthetic gene synthesis as well as complete (bacterial) genome synthesis, and numerous other applications.

The Polymerase Chain Reaction Method Amplifies DNA Sequences

PCR is a method of amplifying a target sequence of DNA. The development of PCR has revolutionized the ways in which both DNA and RNA can be studied. PCR provides a sensitive, selective, and extremely rapid means of amplifying any desired sequence of DNA. Specificity is based on the use of two oligonucleotide primers that hybridize to complementary sequences on opposite strands of DNA and flank the target sequence (**Figure 39–7**). The DNA sample is first heat denatured (>90°C) to separate the two strands of the template DNA containing the target sequence; the primers, added in excess, are allowed to anneal to the DNA (typically at 50-75°C) in order to generate the required template-primer complex. Subsequently, each strand is copied by a DNA polymerase, starting at the primer sites in the presence of all four dXTPs. The two DNA strands each serve as a template for the synthesis of new DNA from the two primers. Repeated cycles of heat denaturation, annealing of the primers to their complementary sequences, and extension of the annealed

primers with DNA polymerase result in the exponential amplification of DNA segments of defined length. Product DNA doubles with each PCR cycle. DNA synthesis is catalyzed by a heat-stable DNA polymerase purified from one of a number of different thermophilic bacteria, organisms that grow at 70 to 80°C. Thermostable DNA polymerases withstand short incubations at over 90°, temperatures required to completely denature DNA. These thermostable DNA polymerases have made automation of PCR possible.

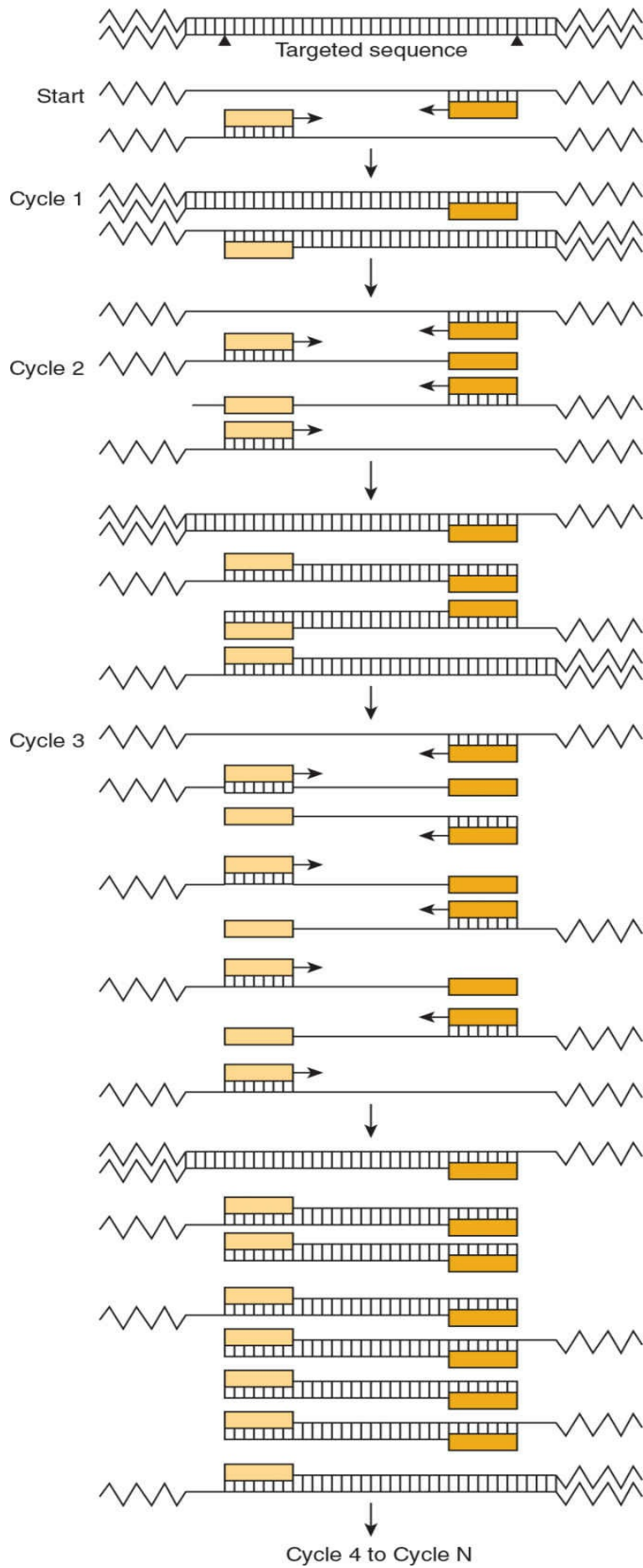

FIGURE 39–7 The polymerase chain reaction technique is used to amplify specific gene sequences. Double-stranded DNA is heated to separate it into individual strands. These bind two distinct primers that are directed at specific sequences on opposite strands and that define the segment to be amplified. DNA polymerase extends the primers in each direction and synthesizes two strands complementary to the original two. This cycle is repeated 30 or more times, giving an amplified product of defined length and sequence. Note that the 4 dXTPs and the two primers are present in excess to minimize the possibility that these components are limiting for polymerization/amplification. It is important to note though that as cycle number increases incorporation rates can drop, and mutation/error rates can increase.

DNA sequences as short as 50 to 100 bp and as long as 10 kb can readily be amplified by PCR. Twenty cycles provide an amplification of 10^6 (ie, 2^{20}) and 30 cycles, 10^9 (2^{30}). Each cycle takes ≤ 5 to 10 minutes so that even large DNA molecules can be amplified fairly rapidly. Because of subtle differences in DNA sequence with each new PCR target, the exact conditions for amplification must be empirically optimized. The workhorse PCR technique is central to many DNA/RNA sequencing technologies. The PCR method allows the DNA in a single cell, hair follicle, or spermatozoon to be amplified and analyzed. Thus, the applications of PCR to forensic medicine are obvious. PCR is also used (1) to detect and quantify infectious agents, especially latent viruses; (2) to make prenatal genetic diagnoses; (3) to detect allelic polymorphisms ranging from single base pair changes to large and small indels and gene amplification; (4) to establish precise tissue types for transplants; and (5) to study evolution, using DNA from archeological samples (6) for quantitative RNA analyses after RNA copying and mRNA quantitation by the so-called RT-PCR method (cDNA copies of mRNA generated by a retroviral reverse transcriptase) or (7) to score in vivo protein-DNA occupancy using chromatin immunoprecipitation assays (see below). New uses of PCR are developed every year.

PRACTICAL APPLICATIONS OF RECOMBINANT DNA TECHNOLOGY ARE NUMEROUS

The isolation of a specific (ca 1000 bp) mRNA-encoding gene from an

entire human genome requires a technique that will discriminate one part in a million. The identification of a regulatory region that may be only 10 bp in length requires a sensitivity of one part in 3×10^8 ; a disease such as sickle cell anemia is caused by a single base change, or one part in 3×10^9 . DNA technology is powerful enough to accomplish all these things.

Gene Mapping Localizes Specific Genes to Distinct Chromosomes

Gene localization can define a map of the human genome. This is already yielding useful information in the definition of human disease. Somatic cell hybridization and in situ hybridization are two techniques historically used to accomplish this. In **in situ hybridization**, the simpler and more direct procedure, a radioactive probe is added to a metaphase spread of chromosomes on a glass slide. The exact area of hybridization is localized by layering photographic emulsion over the slide and, after exposure, lining up the grains with some histologic identification of the chromosome. **Fluorescence in situ hybridization (FISH)**, which utilizes fluorescent rather than radioactively labeled probes, is a very sensitive technique that is also used for this purpose. This often places the gene at a location on a given band or region on the chromosome. Some of the human genes localized using these techniques are listed in **Table 39–4**. This table represents only a sampling of mapped genes since tens of thousands of genes have been mapped as a result of the sequencing of human genomes. Once the defect is localized to a region of DNA that has the characteristic structure of a gene, a synthetic cDNA copy of the gene can be constructed, which contains only mRNA-encoding exons, and expressed in an appropriate vector and its function can be assessed—or the putative polypeptide, deduced from the open reading frame in the coding region, can be synthesized. Antibodies directed against this protein or peptide fragments derived therefrom can be used to assess whether this protein is expressed in normal persons and whether it is absent, or altered in those with the genetic syndrome.

TABLE 39–4 Localization of Human Genes^a

Gene	Chromosome	Disease
Insulin	11p15	Diabetes
Prolactin	6p23-q12	Sheehan syndrome
Growth hormone	17q21-qter	Growth hormone deficiency
α -Globin	16p12-pter	α -Thalassemia
β -Globin	11p12	β -Thalassemia, sickle cell
Adenosine deaminase	20q13-qter	Adenosine deaminase deficiency
Phenylalanine hydroxylase	12q24	Phenylketonuria
Hypoxanthine-guanine phosphoribosyltransferase	Xq26-q27	Lesch-Nyhan syndrome
DNA segment G8	4p	Huntington chorea

^aThis table indicates the chromosomal location of several genes and the diseases associated with deficient or abnormal production of the gene products. The chromosome involved is indicated by the first number or letter. The other numbers and letters refer to precise localizations, as defined in McKusick VA: *Mendelian Inheritance in Man: Catalogs of Autosomal Dominant, Autosomal Recessive, and X-Linked Phenotypes*. Baltimore: Johns Hopkins University Press; 1983.

Proteins Can Be Produced for Research, Diagnosis, & Commerce

A practical goal of recombinant DNA research is the production of materials for biomedical applications. This technology has two distinct merits: (1) it can supply large amounts of material that could not be obtained by conventional purification methods (eg, interferon, tissue plasminogen activating factor, etc); and (2) it can provide human proteins (eg, insulin and growth hormone). The advantages in both cases are obvious. Although the primary aim is to supply products—generally proteins—for treatment (insulin) and diagnosis (AIDS testing) of human and other animal diseases and for disease prevention (hepatitis B vaccine), there are other potential commercial applications, especially in agriculture.

An example of the latter is the attempt to engineer plants that are more resistant to drought or temperature extremes, more efficient at fixing nitrogen, or that produce seeds containing the complete complement of essential amino acids (rice, wheat, corn, etc).

Recombinant DNA Technology Is Used in the Molecular Analysis of Disease

Normal Gene Variations

There is a normal variation of DNA sequence just as it is true of more obvious aspects of human structure. Variations of DNA sequence, **polymorphisms**, occur approximately once in every 500 to 1000 nucleotides. A recent comparison of the nucleotide sequence of the genome of James Watson, the codiscoverer of DNA structure, identified about 3,300,000 single-nucleotide polymorphisms (SNPs) relative to the “standard” initially sequenced human reference genome. Interestingly, >80% of the SNPs found in Watson’s DNA had already been identified in other individuals. There are also genomic deletions and insertions of DNA (ie, **copy number variations; CNVs**) as well as single-base substitutions. In healthy people, these alterations obviously occur in noncoding regions of DNA or at sites that cause no change in function of the encoded protein. This heritable polymorphism of DNA structure can be associated with certain diseases within a large kindred and can be used to search for the specific gene involved, as is illustrated below. It can also be used in a variety of applications in forensic medicine.

Gene Variations Causing Disease

Classic genetics taught that genetic diseases were due to point mutations that resulted in an impaired protein. This may still be true, but if on reading previous chapters one predicted that genetic disease could result from derangement of any of the steps leading from replication to transcription to RNA processing/transport and protein synthesis, PTMs, and/or subcellular localization and physical state (ie, aggregation and polymerization), one would have made a proper assessment. This point is again nicely illustrated by examination of the β -globin gene. This gene is located in a cluster on chromosome 11 (**Figure 39–8**), and an expanded version of the gene is illustrated in **Figure 39–9**. Defective production of β -globin results in a variety of diseases and is due to many different lesions in and around the β -globin gene (**Table 39–5**).

TABLE 39–5 Structural Alterations of the β -Globin Gene

Alteration	Function Affected	Disease
Point mutations	Protein folding	Sickle cell disease
	Transcriptional control	β -Thalassemia
	Frameshift and nonsense mutations	β -Thalassemia
	RNA processing	β -Thalassemia
Deletion	mRNA production	β^0 -Thalassemia
		Hemoglobin Lepore
Rearrangement	mRNA production	β -Thalassemia type III

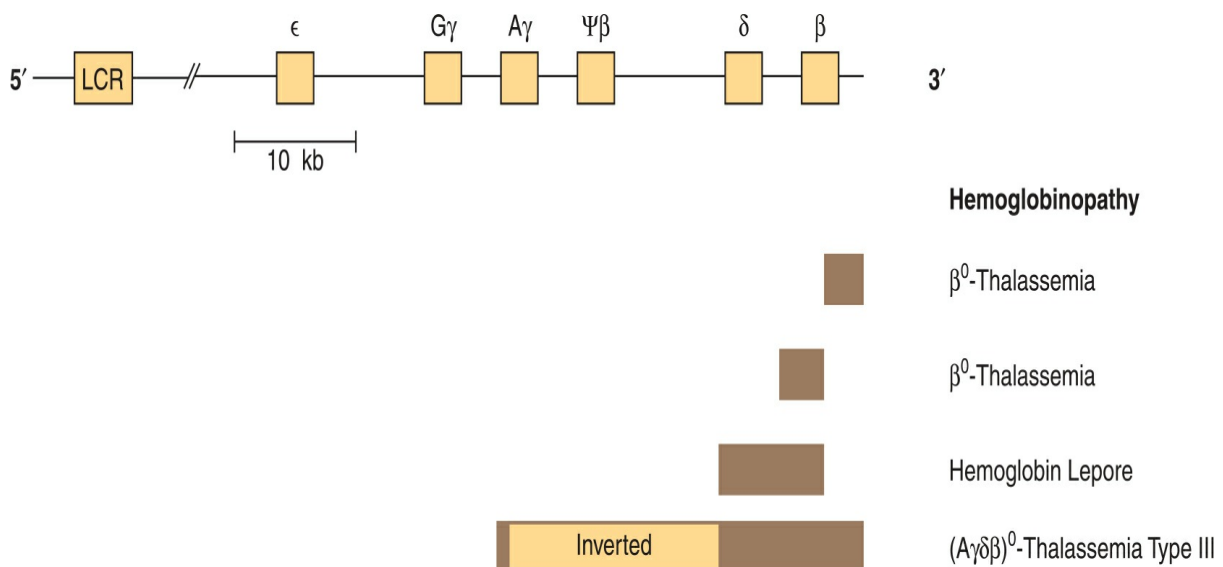

FIGURE 39–8 Schematic representation of the β -globin gene cluster and of the lesions in some genetic disorders. The β -globin gene is located on chromosome 11 in close association with the two γ -globin genes and the δ -globin gene. The β -gene family is arranged in the order 5'- ϵ - $G\gamma$ - $A\gamma$ - $\Psi\beta$ - δ - β -3'. The ϵ locus is expressed in early embryonic life (as $\alpha_2\epsilon_2$). The γ -genes are expressed in fetal life, making fetal hemoglobin (HbF, $\alpha_2\gamma_2$). Adult hemoglobin consists of HbA ($\alpha_2\beta_2$) or HbA 2 ($\alpha_2\delta_2$). The $\Psi\beta$ is a pseudogene that has sequence homology with β but contains mutations that prevent its expression. A locus control region (LCR), a powerful enhancer located upstream (5') of these six genes, controls the rate of transcription of the entire β -globin gene cluster. Deletions (solid

darker bars, lower) within the β locus cause β -thalassemia (deficiency or absence [β^0] of β -globin). Meiotic recombination between δ and β causes hemoglobin Lepore, and results in DNA deletion and δ - β coding sequence fusions reducing the levels of HbB (see [Figures 6–7](#) and 35–10). An inversion ($A\gamma\delta\beta$)⁰ in this region (largest bar) disrupts gene function and also results in thalassemia (type III). Each type of thalassemia tends to be found in a certain group of people, for example, the ($A\gamma\delta\beta$)⁰ deletion inversion occurs in persons from India. Many more deletions in this region have been mapped, and each causes some type of thalassemia.

Point Mutations

The classic example is **sickle cell disease**, which is caused by mutation of a single base out of the 3×10^9 in the genome, a T-to-A DNA substitution, which in turn results in an A-to-U change in the mRNA corresponding to the sixth codon of the β -globin gene. The altered codon specifies a different amino acid (valine rather than glutamic acid), and this causes a structural abnormality of the β -globin molecule leading to hemoglobin aggregation and red blood cell “sickling.” Other point mutations in and around the β -globin gene result in decreased or, in some instances, no production of β -globin; β -thalassemia is the result of these mutations. (The thalassemias are characterized by defects in the synthesis of hemoglobin subunits, and so β -thalassemia results when there is insufficient production of β -globin.) [Figure 39–9](#) illustrates that point mutations affecting each of the many processes involved in generating a normal mRNA (and therefore a normal protein) have been implicated as a cause of β -thalassemia.

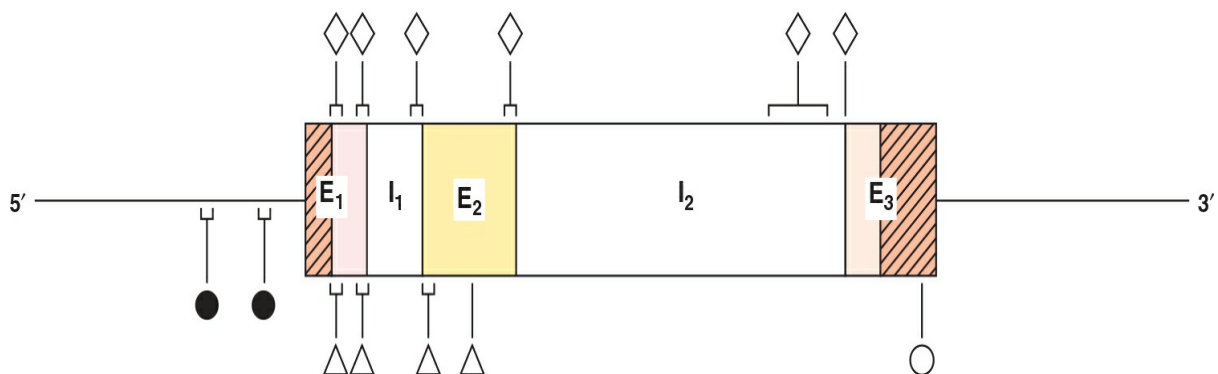

FIGURE 39–9 Mutations in the α -globin gene causing β -thalassemia. The β -globin gene is shown in the 5' to 3' orientation. The cross-hatched areas indicate the 5' and 3' untranslated regions (UTRs). Reading from the 5' to 3' direction, the shaded areas are exons 1 to 3 (E₁, E₂, E₃) and the

white areas between exons are introns 1 (I_1) and 2 (I_2). Mutations that affect transcription control (\bullet) are located in the 5' flanking-region DNA. Examples of nonsense mutations (Δ), mutations in RNA processing (\diamond), and RNA cleavage mutations (O) have been identified and are indicated. In some regions, many distinct mutations have been found. These are indicated by the size and location of the brackets.

Deletions, Insertions, & Rearrangements of DNA

Studies of bacteria, viruses, yeasts, fruit flies, and now humans show that pieces of DNA can move, or transpose, from one place to another within a genome via the process of **DNA transposition**. The deletion of a critical piece of DNA, the rearrangement of DNA within a gene, or the insertion or amplification of a piece of DNA within a coding or regulatory region can all cause changes in gene expression resulting in disease. Again, a molecular analysis of thalassemias produces numerous examples of these processes—particularly deletions—as causes of disease (Figure 39–8). The globin gene clusters seem particularly prone to this lesion. Deletions in the α -globin cluster, located on chromosome 16, cause α -thalassemia. There is a strong ethnic association for many of these deletions, so that northern Europeans, Filipinos, blacks, and Mediterranean peoples have different lesions all resulting in the absence of hemoglobin A and α -thalassemia.

A similar analysis could be made for a number of other diseases. Point mutations are usually defined by sequencing the gene in question, though occasionally, if the mutation destroys or creates a restriction enzyme site, the technique of restriction fragment analysis can be used to pinpoint the lesion. Deletions or insertions of DNA larger than 50 bp can often be detected by the Southern blotting procedure while PCR-based assays can detect much smaller changes in DNA structure.

Pedigree Analysis

Sickle cell disease again provides an excellent example of how recombinant DNA technology can be applied to the study of human disease. The substitution of T for A in the template strand of DNA in the β -globin gene changes the sequence in the region that corresponds to the sixth codon from and destroys a recognition site for the restriction enzyme *MstII* (CCTNAGG; denoted by the small vertical arrows; Table 39–1).

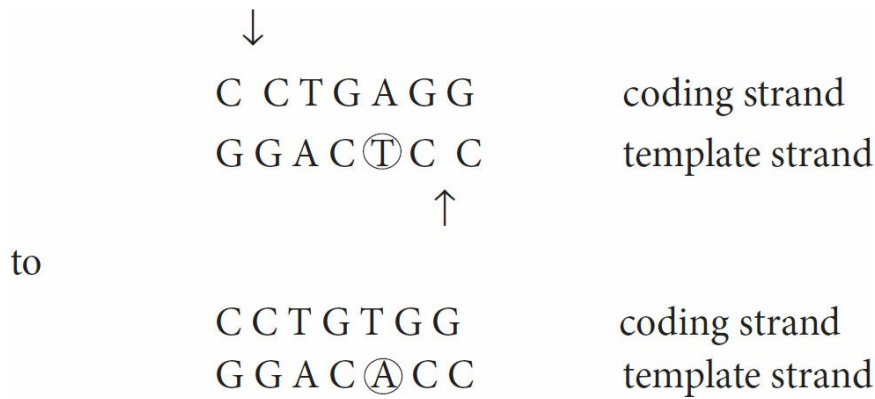

Other *MstII* sites 5' and 3' from this site (**Figure 39–10**) are not affected and so will be cut. Therefore, incubation of DNA from normal (AA), heterozygous (AS), and homozygous (SS) individuals results in three different patterns on Southern blot transfer (**Figure 39–10**). This illustrates how a DNA pedigree can be established using the principles discussed in this chapter. Pedigree analysis has been applied to a number of genetic diseases and is most useful in those caused by deletions and insertions or the rarer instances in which a restriction endonuclease cleavage site is affected, as in the example cited here. Such analyses are now facilitated by the PCR reaction, which can amplify and hence provide sufficient DNA for analysis from just a few nucleated cells.

A. MstII restriction sites in and around the β -globin gene



B. Pedigree analysis

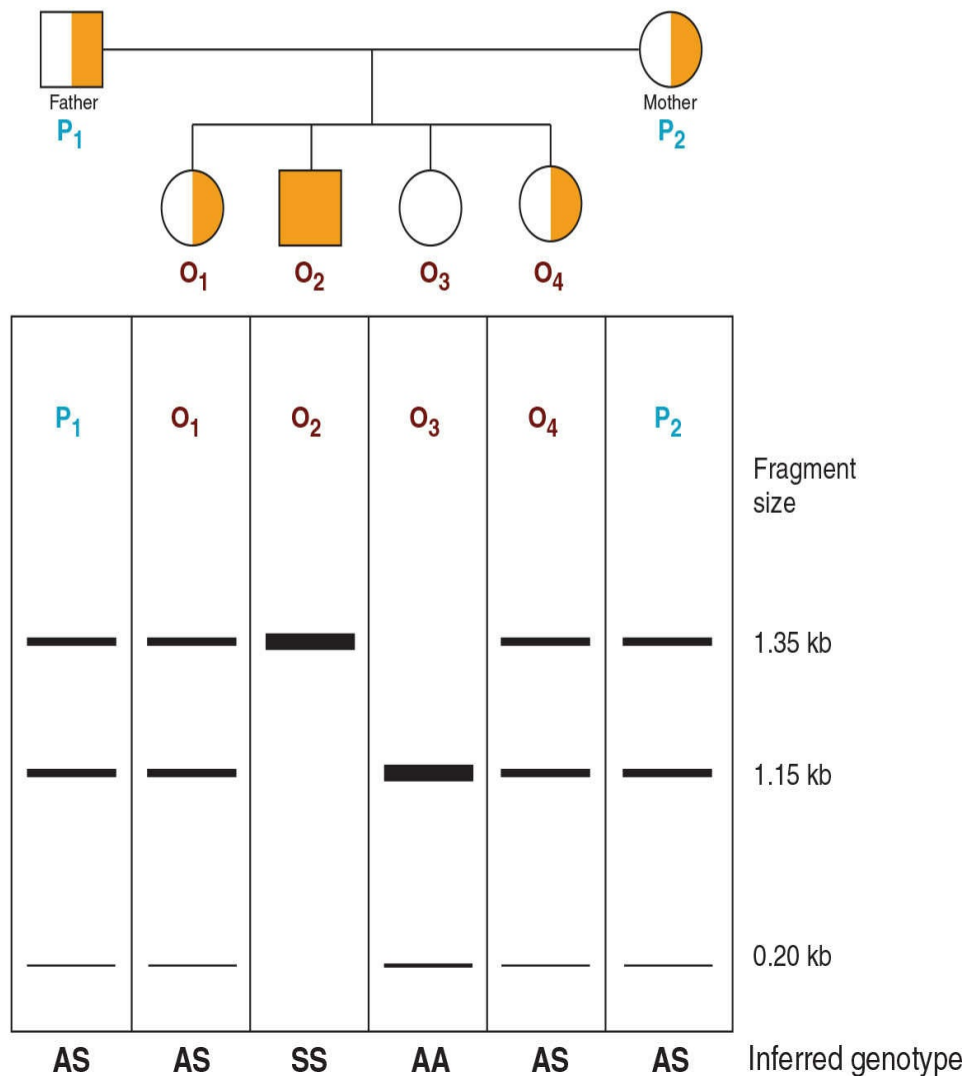

FIGURE 39–10 Pedigree analysis of sickle cell disease. The top part of the figure (A) shows the first part of the β -globin gene and the *MstII* restriction enzyme sites in the normal (A) and sickle cell (S) β -globin

genes. Digestion with the restriction enzyme *MstII* results in DNA fragments 1.15- and 0.2-kb long in normal individuals. The T-to-A change in individuals with sickle cell disease abolishes one of the three *MstII* sites around the β -globin gene; hence, a single restriction fragment 1.35 kb in length is generated upon cleavage with *MstII*. This size difference is easily detected on a Southern blot. **(B)** Pedigree analysis shows three possibilities for four offspring O₁, O₂, O₃ and O₄, given Parental (P₁, P₂) heterozygous genotypes (**AS**): AA, normal (open circle); AS, heterozygous (half-solid circles, half-solid square); SS, homozygous (solid square). This approach can allow for prenatal diagnosis of sickle cell disease (dash-sided square).

Prenatal Diagnosis

If the genetic lesion is understood and a specific probe is available, prenatal diagnosis is possible. DNA from cells collected from a small volume of amniotic fluid (or by chorionic villus biopsy) can be analyzed by Southern blot transfer, and much smaller volumes if PCR-based assays are used. A fetus with the restriction pattern AA in [Figure 39–10](#) neither has sickle cell disease, nor is it a carrier. A fetus with the SS pattern will develop the disease. Probes are now available for this type of analysis of many genetic diseases.

Restriction Fragment Length Polymorphism and SNPs

The differences in DNA sequence cited above can result in variations of restriction sites and thus in the length of restriction fragments. Similarly, **SNPs** can be detected by the sensitive PCR method. An inherited difference in the pattern of restriction enzyme digestion (eg, a DNA variation occurring in more than 1% of the general population) is known as a **restriction fragment length polymorphism (RFLP)**. Extensive RFLP and SNP maps of the human genome have been constructed. This is proving useful in the Human Genome Analysis Project and is an important component of the effort to understand various single-gene and multigenic diseases. RFLPs result from single-base changes (eg, sickle cell disease) or from deletions or insertions (CNVs) of DNA into a restriction fragment (eg, the thalassemias) and have proved to be useful diagnostic tools. They have been found at known gene loci and in sequences that have no known function; thus, RFLPs or SNPs may disrupt the function of the gene or may have no apparent biologic consequences. As mentioned above, 80%

of the SNPs in the genome of a single known individual had already been mapped independently through the efforts of the SNP-mapping component of the International HapMap Project and now supplemented by genomic sequencing.

RFLPs and SNPs are inherited, and they segregate in a mendelian fashion. A major use of SNPs/RFLPs is in the definition of inherited diseases in which the functional deficit is unknown. SNPs/RFLPs can be used to establish linkage groups, which in turn, by the processes of pedigree analyses and **chromosome walking**, will eventually define the disease locus. In chromosome walking (**Figure 39–11**), a fragment representing one end of a long piece of DNA is used to isolate another that overlaps but extends the first. The direction of extension is determined by restriction mapping, and the procedure is repeated sequentially until the desired sequence is obtained. Collections of mapped, overlapping BAC- or PAC-cloned human genomic DNAs are commercially available. The X chromosome–linked disorders are particularly amenable to the approach of chromosome walking since only a single allele is expressed. Hence, 20% of the defined RFLPs are on the X chromosome and a complete linkage map (and genomic sequence) of this chromosome have been determined. The gene for the X-linked disorder, Duchenne-type muscular dystrophy, was found using RFLPs. Similarly, the defect in Huntington disease was localized to the terminal region of the short arm of chromosome 4, and the defect that causes polycystic kidney disease is linked to the α -globin locus on chromosome 16. Genomic sequencing depends on this “overlap” between sequenced DNA fragments to assemble complete genomic DNA sequences.

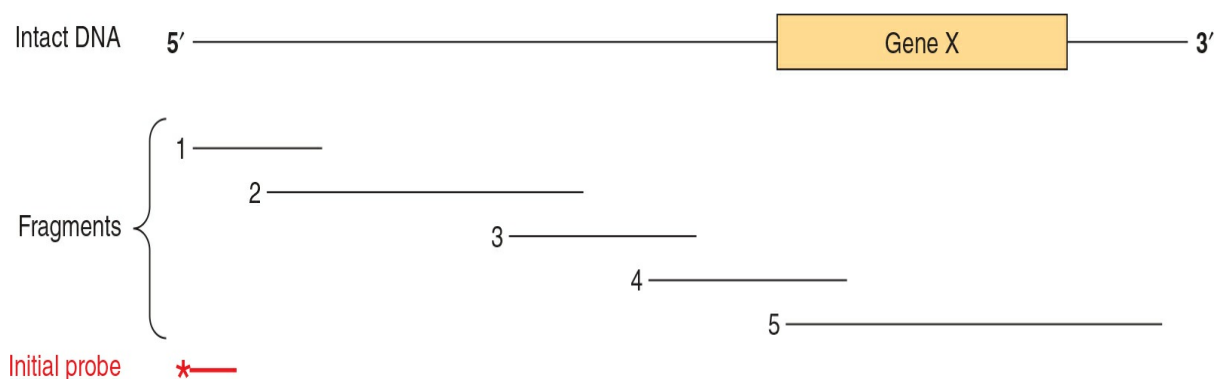

FIGURE 39–11 The technique of chromosome walking. Gene X is to be isolated from a large piece of DNA. The exact location of this gene is not known, but a probe (*____) directed against a fragment of DNA (shown at the 5' end in this representation) is available, as is a library of

clones containing a series of overlapping DNA insert fragments. For the sake of simplicity, only five of these are shown. The initial probe will hybridize only with clones containing fragment 1, which can then be isolated and used as a probe to detect fragment 2. This procedure is repeated until fragment 4 hybridizes with fragment 5, which contains the entire sequence of gene X. A conceptually similar method of DNA sequence overlap is used to assemble the contiguous sequence reads generated by direct NGS/high-throughput sequencing of genomic DNA fragments.

Microsatellite DNA Polymorphisms

Short (2-6 bp), inherited, tandem repeat units of DNA occur about 50,000 to 100,000 times in the human genome (see [Chapter 35](#)). Because they occur more frequently, and in view of the routine application of sensitive PCR methods, they are replacing RFLPs as the marker loci for various genome searches.

RFLPs & VNTRs in Forensic Medicine

Variable numbers of tandemly repeated (VNTR) units are one common type of “insertion” that results in an RFLP. The VNTRs can be inherited, in which case they are useful in establishing genetic association with a disease in a family or kindred; or they can be unique to an individual and thus serve as a molecular fingerprint of that person.

Direct Sequencing of Genomic DNA

As noted above, recent advances in DNA-sequencing technology, the so-called next-generation (NGS), or high-throughput sequencing (HTS) platforms, have dramatically reduced the per base cost of DNA sequencing. The initial sequence of the human genome costs roughly \$350,000,000 (US). The cost of sequencing the same 3×10^9 bp diploid human genome using the new NGS platforms is estimated to be <0.03% of the original. Very recently, the technology has been developed to allow for human genome sequencing for \$1000 (US). This dramatic reduction in cost has stimulated various international initiatives to sequence the entire genomes of thousands of individuals of various racial and ethnic backgrounds in order to determine the true extent of DNA/genome polymorphisms present within the human population. The resulting cornucopia of genetic information, and the ever-decreasing cost of genomic DNA sequencing is dramatically increasing our ability to

diagnose and, ultimately treat human disease. Obviously, when personal genome sequencing does become commonplace, dramatic changes in the practice of medicine will result because therapies will ultimately be custom tailored to the exact genetic makeup of each individual.

Gene Therapy and Stem Cell Biology

Diseases caused by deficiency of a single gene product (Table 39–4) are all theoretically amenable to replacement therapy. The strategy is to clone a normal copy of the relevant gene (eg, the gene that codes for adenosine deaminase) into a vector that will readily be taken up and incorporated into the genome of a host cell. Bone marrow precursor cells are being investigated for this purpose because they presumably will resettle in the marrow and replicate there. The introduced gene would begin to direct the expression of its protein product, and this would correct the deficiency in the host cell.

As an alternative to “replacing” defective genes to cure human disease, many scientists are investigating the feasibility of identifying and characterizing pluripotent stem cells that have the ability to differentiate into any cell type in the body. Recent results in this field have shown that adult human somatic cells can readily be converted into apparent **induced pluripotent stem cells (iPSCs)** by transfection with cDNAs encoding a handful of DNA-binding transcription factors. These and other new developments in the fields of gene therapy and stem cell biology promise exciting new potential therapies for curing human disease. Finally, generating iPSCs from diseased patient cells also offer the opportunity to create authentic human cell–based models for laboratory studies of the molecular basis of human disease.

Transgenic Animals

The somatic cell gene replacement therapy described above would obviously not be passed on to offspring. Other strategies to alter germ cell lines have been devised but have been tested only in experimental animals. A certain percentage of genes injected into a fertilized mouse ovum will be incorporated into the genome and found in both somatic and germ cells. Hundreds of transgenic animals have been established, and these are useful for analysis of tissue-specific effects on gene expression and effects of overproduction of gene products (eg, those from the growth hormone gene or oncogenes) and in discovering genes involved in development, a process that heretofore has been difficult to study in mammals. The

transgenic approach has been used to correct a genetic deficiency in mice. Fertilized ova obtained from mice with genetic hypogonadism were injected with DNA containing the coding sequence for the gonadotropin-releasing hormone (GnRH) precursor protein. This gene was expressed and regulated normally in the hypothalamus of a certain number of the resultant mice, and these animals were in all respects normal. Their offspring also showed no evidence of GnRH deficiency. This is, therefore, evidence of somatic cell expression of the transgene and of its maintenance in germ cells.

Targeted Gene Regulation by Disruption or Knockout, Knockin, Editing, and Controlled Expression

Various technical advances have allowed for the precise, targeted modification of mammalian genes. The exact methods used for genetically engineering mammalian genomes have evolved from tedious, low-efficiency methods based on positive and negative drug selections and homologous recombination (Knockout/Knockin) to the recently described CRISPR-Cas9 system described above. The goal of all of these methods is ultimately to generate a family of genetic variants of a gene of interest that are (a) a null, or complete loss-of-function allele; (b) recessive, loss-of-function alleles; and (c) ideally, dominant gain-of-function alleles. These genetic alterations are generated in pluripotent stem cells, which ultimately allow for introduction and propagation in whole model organisms (flies, fish, worms, rodents, etc). Having all three of these genetic variants allows one to precisely dissect the mechanism of action of any gene. However, complicating genetic analyses of many genes is the fact that their function(s) are essential for viability. To get around this problem, cell-type or tissue-specific genetic variants must be generated. This hurdle has been overcome through the use of cell- and tissue-specific enhancers that can drive the conditional (ie, experimentally controlled) expression of the targeting recombinases (ie, CRE-lox) and/or nuclease (CRISPR-Cas9) that generate the altered genes, either null or loss- or gain-of-function alleles. Alternatively, selected loss-of-function alleles can be generated through equivalent siRNA expression to knock down production of a specific gene product. Collectively, these methods allow for sophisticated genetic and biochemical tests of gene function and allow scientists to probe the structure and function of mammalian genes in physiologic contexts. Tremendous molecular mechanistic insights have been, and will

continue to be, obtained into the molecular etiology of human disease through these and other biochemical approaches. Exciting times lie ahead!

RNA and Protein Profiling, and Protein-DNA Interaction Mapping

The “-omic” revolution of the last decade has culminated in the determination of the complete nucleotide sequence of tens of thousands of genomes, including those of budding and fission yeasts, numerous bacteria, the fruit fly, the worm *Caenorhabditis elegans*, plants, the mouse, rat, chicken, monkey, and, most notably, humans. Additional genomes are being sequenced at an accelerating pace. The availability of all of this DNA sequence information, coupled with engineering advances, has led to the development of several revolutionary methodologies, most of which are based on **high-density microarray technology** and **NGS sequencing** platforms. In the case of microarrays, it is now possible to deposit thousands of specific, known, defined DNA sequences on a glass microscope-style slide, or other inert support, in the space of a few square centimeters. By coupling such DNA microarrays with highly sensitive detection of hybridized fluorescently labeled nucleic acid probes derived from mRNA, investigators can rapidly and accurately generate profiles of gene expression (eg, specific cellular mRNA content) from cell and tissue samples as small as 1 g or less. Thus, entire **transcriptome information** (the entire collection of cellular RNAs) for such cell or tissue sources can readily be obtained in only a few days. In the case of NGS sequencing, mRNAs are converted to cDNAs using reverse transcription, and these cDNAs are amplified and directly sequenced; this method is termed **RNA-Seq**. These methods allow for the quantitative description of the entire transcriptome. Recent reports in the literature have used RNA-Seq to describe the transcriptome of single cells, and when coupled with high-sensitivity ribosome profiling (see below) and mass spectrometry-based proteomics (see below), confidently define gene expression profiles at the mRNA and protein levels.

Recent methodologic advances (**PRO-Seq**, Precision Run-On sequencing, and **NET-seq**, native elongating transcript sequencing) allow for sequencing of RNA within elongating RNA polymerase-DNA-RNA ternary complexes, thereby allowing nucleotide-level descriptions, genome-wide, of active transcription in living cells. A parallel method termed **ribosome profiling** allows investigators to use high-throughput DNA sequencing to determine both the identity and number of cellular

mRNAs in the process of being actively translated—thereby defining the cellular proteome. Transcriptome information allows one to quantitatively *predict* the collection of proteins that might be expressed in a particular cell, tissue, or organ in normal and disease states based on the mRNAs present in those cells, while ribosome profiling allows for the quantitative measurement of the *actual* cellular proteome.

Complementing the very high-throughput, genome-wide expression profiling methods described above is the development of methods to map the location, or occupancy of specific proteins bound to discrete DNA sequences within living cells. This method, illustrated in [Figure 39–12](#), is termed **chromatin immunoprecipitation (ChIP)**. Proteins are cross-linked in situ in cells or tissues, the cellular chromatin is isolated, sheared, and specific cross-linked protein-DNA complexes purified using antibodies that recognize a particular protein, or protein isoform. DNA bound to this protein is recovered and amplified using PCR and analyzed using gel electrophoresis imaging, microarray hybridization (**ChIP-chip**), or direct sequencing. There are two versions of the DNA sequencing assay readout. In the first, the immunopurified DNA is directly subjected to NGS/high-throughput DNA sequencing (**ChIP-Seq**); in the second version, the immunopurified, cross-linked protein-DNA complex is treated with exonucleases to remove cross-linked DNA sequences that are not in intimate contact with the protein of interest; this is termed **ChIP-Exo**. Collectively ChIP-chip and ChIP-Seq methods allow investigators to identify the locations of a single protein genome-wide throughout all the chromosomes. ChIP-Exo has the added advantage of allowing investigators to map in vivo protein occupancy at single nucleotide-level resolution. Finally, methods for high-sensitivity, high-throughput mass spectrometry of metabolites (**metabolomics**), various small molecules (lipids, **lipidomics**; carbohydrates, **glycomics, etc**), and complex protein samples (**proteomics**) have been developed. Newer mass spectrometry methods allow scientists to identify hundreds to thousands of proteins in complex samples extracted from very small numbers of cells (<1 g). Such analyses can now be used to quantify the relative amounts of proteins in two samples, as well as the level of certain PTMs, such as phosphorylation, acetylation etc; and with the use of specific antibodies, define specific protein–protein interactions. This critical information tells investigators which of the many mRNAs detected in transcriptome mapping studies are being translated into protein, generally the ultimate dictator of phenotype.

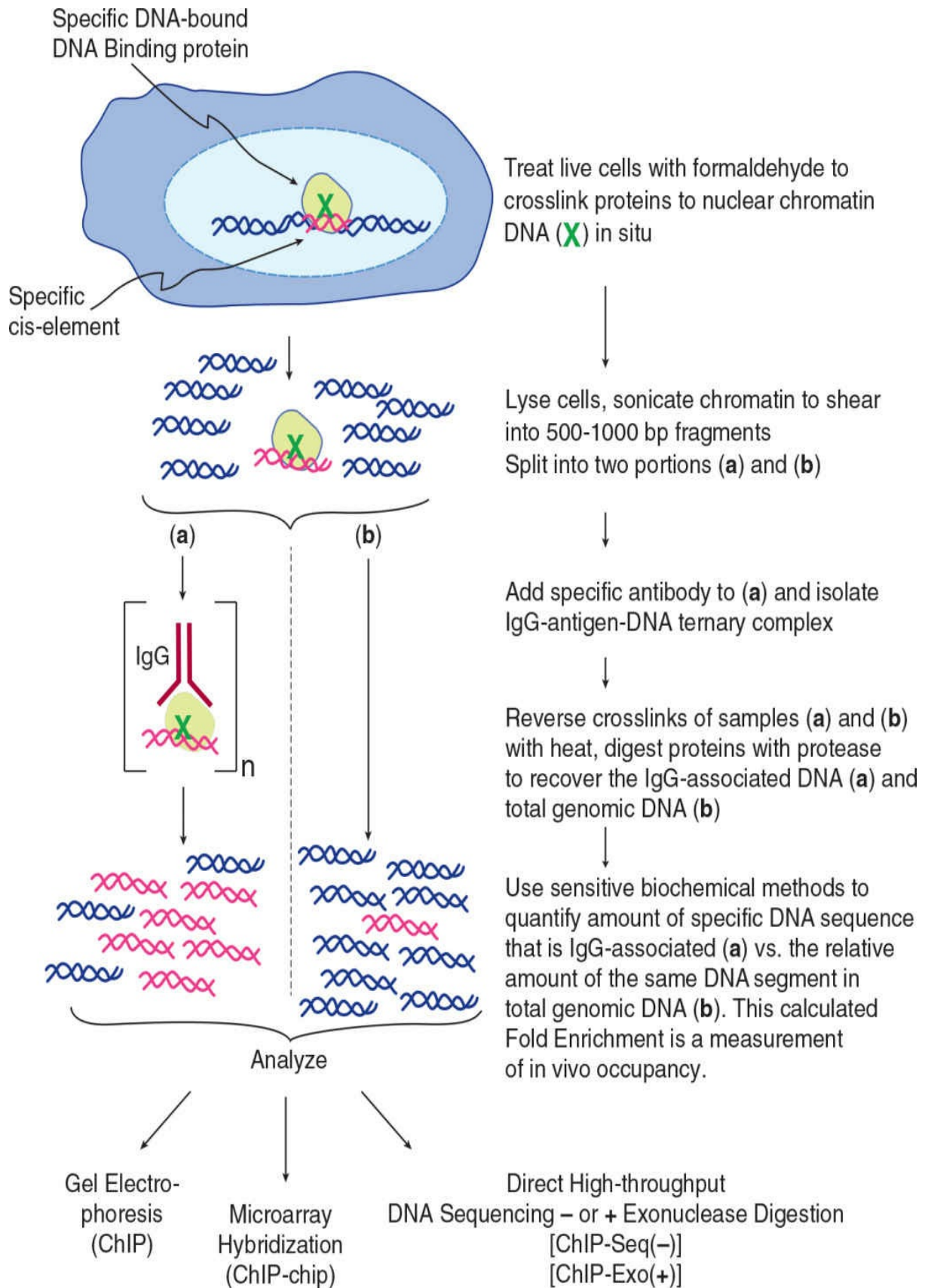

FIGURE 39–12 Outline of the chromatin immunoprecipitation (ChIP) technique. This method allows for the precise localization of a

particular protein (or modified protein if an appropriate antibody is available; eg, **n** = anti-phosphorylated or acetylated histones, transcription factors, etc) on a particular sequence element in living cells. Depending on the method used to analyze the immunopurified DNA, quantitative or semiquantitative information, at near nucleotide level resolution, can be obtained. Protein-DNA occupancy can be scored genome-wide in two ways. First, by ChIP-chip, a method that uses a hybridization readout. In ChIP-chip total genomic DNA is labeled with one particular fluorophore and the immunopurified DNA is labeled with a spectrally distinct fluorophore. These differentially labeled DNAs are mixed and hybridized to microarray “chips” (microscope slides) that contain specific DNA fragments, or more commonly now, synthetic oligonucleotide 50 to 70 nucleotides long. These gene-specific oligonucleotides are deposited and covalently attached at predetermined, known X,Y position/coordinates on the slide. The labeled DNAs are hybridized, the slides washed and hybridization to each gene-specific oligonucleotide probe is scored using differential laser scanning and sensitive photodetection at micron resolution. The hybridization signal intensities are quantified, and the ratio of IP DNA/genomic DNA signals is used to score occupancy levels. The second method, termed ChIP-Seq, directly sequences immunopurified DNAs using NGS sequencing methods. Two variants of ChIP-Seq are shown: “standard” ChIP-Seq and ChIP-Exo. These two approaches differ in their ability to resolve and map the locations of the bound protein on genomic DNA. Standard ChIP-Seq resolution is 50 to 100 nt resolution, while ChIP-Exo has near single nt level resolution. Both approaches rely on efficient bioinformatic algorithms to deal with the very large datasets that are generated. ChIP-chip and ChIP-Seq techniques provide a (semi-) quantitative measure of in vivo protein occupancy. Though not schematized here, similar methods termed RIP (RNA immunoprecipitation) or CLIP (cross-linking protein-RNA and immunoprecipitation), which differ primarily in the method of protein-RNA cross-linking, can score the in vivo binding of specific proteins to specific RNA species (typically mRNAs, though any RNA species can be analyzed by these techniques).

New genetic means for identifying protein–protein interactions and protein function have also been devised. Systematic genome-wide gene expression knockdown using siRNAs, synthetic lethal genetic interaction screens, or most recently CRISPR-Cas9 knockdown have been used to assess the contribution of individual genes to a variety of processes in

model systems (yeast, worms, and flies) and mammalian cells (human and mouse). Specific network mappings of protein–protein interactions, on a genome-wide basis, have been identified using high-throughput variants of the **two-hybrid interaction** test (**Figure 39–13**). This simple yet powerful method can be performed in bacteria, yeast, or metazoan cells, and allows for the detection of specific protein–protein interactions in living cells. Reconstruction experiments indicate that protein–protein interactions with binding affinities of $>K_d \sim 10^{-6}$ mol/L can readily be detected with this method. Together, these technologies provide powerful tools with which to dissect the intricacies of human biology.

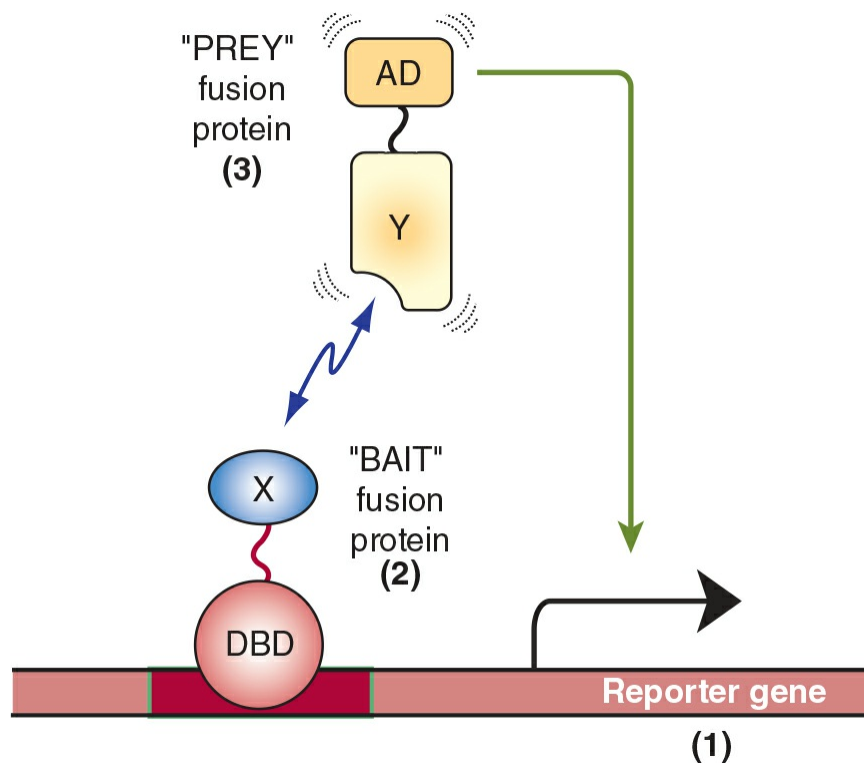

FIGURE 39–13 Overview of two hybrid system for identifying and characterizing protein–protein interactions. Shown are the basic components and operation of the two hybrid systems, originally devised by Fields and Song (Nature 340:245-246 [1989]) to function in the baker’s yeast system. **(1)** A reporter gene, either a selectable marker (ie, a gene conferring prototrophic growth on selective media, or producing an enzyme for which a colony colorimetric assay exists, such as β -galactosidase) that is expressed only when a transcription factor binds upstream to a *cis*-linked enhancer (dark red bar). **(2)** A “bait” fusion protein (**DBD-X**) produced from a chimeric gene expressing a modular DNA-binding domain (**DBD**; often derived from the yeast Gal4 protein or the bacterial Lex A protein, both high-affinity, high-specificity DNA-

binding proteins) fused in-frame to a protein of interest, here X. In two hybrid experiments, one is testing whether any protein can interact with protein X. Prey protein X may be fused in its entirety or often alternatively just a portion of protein X is expressed in-frame with the DBD. (3) A “prey” protein (**Y-AD**), which represents a fusion of a specific protein fused in-frame to a transcriptional activation domain (**AD**; often derived from either the *herpes simplex* virus VP16 activator protein or the yeast GAL4 protein). This system serves as a useful test of protein–protein interactions between proteins X and Y because in the absence of a functional transactivator binding to the indicated enhancer, no transcription of the reporter gene occurs (ie, see [Figure 38–16](#)). Thus, one observes transcription only if protein X–protein Y interaction occurs, thereby bringing a functional AD to the *cis*-linked transcription unit, in this case activating transcription of the reporter gene. In this scenario, protein DBD-X alone fails to activate reporter transcription because the X-domain fused to the DBD does not contain an AD. Similarly, protein Y-AD alone fails to activate reporter gene transcription because it lacks a DBD to target the Y-AD protein to the enhancer-promoter-reporter gene. Only when both proteins are expressed in a single cell and bind the enhancer and, via DBD-X–Y-AD protein–protein interactions, regenerate a functional transactivator binary “protein,” does reporter gene transcription result in activation and mRNA synthesis (green line from AD to reporter gene).

SYSTEMS BIOLOGY AIMS TO INTEGRATE THE FLOOD OF–OMIC DATA IN ORDER TO DECIPHER FUNDAMENTAL BIOLOGIC REGULATORY PRINCIPLES

Microarray techniques, high-throughput genomic DNA sequencing, RNA-Seq, ribosome profiling, mass spectrometry, ChIP-Seq/ChIP-Exo, genome-wide two-hybrid screens, genetic knockdown, and synthetic lethal screens coupled with mass spectrometric protein and metabolite identification experiments have led to the generation of enormous amounts of data. Appropriate data management, analysis, and interpretation of the deluge of information forthcoming from such studies have relied on the application of statistical methods and novel algorithms for analyzing or “mining” and visualizing such huge datasets. This has led to the development of the field of **bioinformatics** (see also [Chapter 11](#)). These new technologies, coupled with the flood of experimental data, have further led to the development of

the field of **systems biology**, a discipline whose goal is to quantitatively analyze, and integrate this flood of biologically important information in order to gain novel insights into biology and its pathologic manifestations. Future work at the intersection of bioinformatics, engineering, biophysics, genetics, transcript, protein, protein PTM profiling, and systems biology will revolutionize our understanding of physiology and medicine and ultimately human health.

SUMMARY

- In DNA cloning, a particular segment of DNA is either directly synthesized, or is removed from its normal environment using PCR or one of many DNA-directed endonucleases. Such DNA is then ligated into a vector in which the DNA segment can be individually amplified and produced in abundance.
- Manipulation of the DNA to change its sequence, so-called genetic engineering, is a key element in cloning (eg, the construction of chimeric molecules) and can also be used to study the function of a certain fragment of DNA and to analyze how genes are regulated.
- A variety of very sensitive techniques can now be applied to the isolation and characterization of genes and to the quantitation of gene products in both static (ie, equilibrium) and dynamic (kinetic) modes. These methods allow for the identification of the genes responsible for diseases, and for the study of how faulty genes/gene regulation causes disease.
- Mammalian genomes can now be precisely engineered to knockin (add/replace a gene), knockout (delete or inactivate), and/or actively and conditionally manipulate specific genes using miRNAs and SiRNAs, and novel genome editing enzymes (recombinases) and enzyme-RNA systems (CRISPR-Cas).

REFERENCES

- Abecasis GR, Auton A, Brooks LD, et al: The 1000 Genomes Project Consortium. An integrated map of genetic variation from 1,092 human genomes. *Nature* 2012;491:56–65. [see also: <http://www.internationalgenome.org>].
- Abudayyeh OO, Gootenberg JS, Konermann S, et al: C2c2 is a single-component programmable RNA-guided RNA-targeting CRISPR effector. *Science* 2016;353(6299):aaf5573.

- Baltimore D, Berg P, Botchan M, et al: Biotechnology. A prudent path forward for genomic engineering and germline gene modification. *Science* 2015;348:36-38.
- Churchman LS, Weissman JS: Nascent transcript sequencing visualizes transcription at nucleotide resolution. *Nature* 2011;469:368-373.
- Collins FS, Varmus H: A new initiative on precision medicine. *N Engl J Med* 2015;372:793-795.
- Deng Q, Ramsköld D, Reinius B, et al: Single-cell RNA-seq reveals dynamic, random monoallelic gene expression in mammalian cells. *Science* 2014;343:193-196.
- Gandhi TK, Zhong J, Mathivanan S, et al: Analysis of the human protein interactome and comparison with yeast, worm and fly interaction datasets. *Nat Genet* 2006;38:285-293.
- Gibson DG, Glass JI, Lartigue C, et al: Creation of a bacterial cell controlled by a chemically synthesized genome. *Science* 2010;329:52-56.
- Green MR, Sambrook J: *Molecular Cloning: A Laboratory Manual*, 4th ed. Cold Spring Harbor Laboratory Press, 2012.
- Horvath P, Barrangou R: CRISPR/Cas, the immune system of bacteria and archaea. *Science* 2010;327:167-170.
- Ingolia TN: Ribosome footprint profiling of translation throughout the genome. *Cell* 2016;165:22-33.
- Kwak H, Fuda NJ, Core LJ, Lis JT: Precise maps of RNA polymerase reveal how promoters direct initiation and pausing. *Science* 2013;339:950-953.
- Liu SJ, Horlbeck MA, Cho SW, et al: CRISPRi-based genome-scale identification of functional long noncoding RNA loci in human cells. *Science* 2017;355:355(6320).
- Martin JB, Gusella JF: Huntington's disease: pathogenesis and management. *N Engl J Med* 1986;315:1267-1276.
- Morgan MA, Shilatifard A: Chromatin signatures of cancer. *Genes Dev* 2015;29:238-249.
- Myers RM, Stamatoyannopoulos J, Snyder M, et al: A user's guide to the encyclopedia of DNA elements (ENCODE). *PLoS Biol* 2011;9:e1001046.
- Rhee HS, Pugh BF: Comprehensive genome-wide protein-DNA interactions detected at single-nucleotide resolution. *Cell* 2011;147:1408-1419.
- Sampson TR, Weiss DS: Exploiting CRISPR/Cas systems for

- biotechnology. *Bioessays* 2014;36:34-38.
- Sudmant PH, Rausch T, Gardner EJ, et al: An integrated map of structural variation in 2,504 human genomes. *Nature* 2015;526:75-81.
- Tajuddin SM, Schick UM, Eicher JD, et al: Large-scale exome-wide association analysis identifies loci for white blood cell traits and pleiotropy with immune-mediated diseases. *Am J Hum Genet* 2016;99:22-39.
- Takahashi K, Tanabe K, Ohnuki M, et al: Induction of pluripotent stem cells from adult human fibroblasts by defined factors. *Cell* 2007;131:861-872.
- The 1000 Genome Project Consortium: A global reference for human genetic variation. *Nature* 2015;526:68-74.
- Wang L, Wheeler DA: Genomic sequencing for cancer diagnosis and therapy. *Annu Rev Med* 2014;65:33-48.
- Weatherall DJ: A journey in science: early lessons from the hemoglobin field. *Mol Med* 2014;20:478-485.
- Wheeler DA, Srinivasan M, Egholm M, et al: The complete genome of an individual by massively parallel DNA sequencing. *Nature* 2008;452:872-876.

GLOSSARY

- ARS:** Autonomously replicating sequence; the origin of replication in yeast.
- Autoradiography:** The detection of radioactive molecules (eg, DNA, RNA, and protein) by visualization of their effects on photographic or x-ray film.
- Bacteriophage:** A virus that infects a bacterium.
- Blunt-ended DNA:** Two strands of a DNA duplex having ends that are flush with each other.
- CAGE:** Cap analysis of gene expression. A method that allows the selective capture, amplification, cloning, and sequencing of mRNAs via the 5'-cap structure.
- cDNA:** A single-stranded DNA molecule that is complementary to an mRNA molecule and is synthesized from it by the action of reverse transcriptase.
- Chimeric molecule:** A molecule (eg, DNA, RNA, and protein) containing sequences derived from two different species.
- ChIP, chromatin immunoprecipitation:** A technique that allows for the

determination of the exact localization of a particular protein, or protein isoform, on any particular genomic location in a living cell. The method is based on cross-linking of living cells, cell disruption, DNA fragmentation, and immunoprecipitation with specific antibodies that purify the cognate protein cross-linked to DNA. Cross-links are reversed, associated DNA purified and specific sequences that are purified are measured using any of several different methods (see next three glossary entries below).

ChIP-chip, chromatin immunoprecipitation assayed via a microarray chip hybridization readout: A hybridization-based method that uses chromatin immunoprecipitation (ChIP) techniques to map, genome-wide, the *in vivo* sites of binding of specific proteins within chromatin in living cells. Sequence binding is determined by annealing fluorescently labeled ChIP DNA samples to microarrays (array).

ChIP-Exo, chromatin immunoprecipitation assayed via a NGS/deep sequencing readout after treatment of immunoprecipitated protein-DNA complexes with exonucleases: A variation on ChIP-Seq (see next entry) that allows nucleotide-level precision in the mapping and description of DNA *cis*-elements bound by a particular protein.

ChIP-Seq, chromatin immunoprecipitation assayed via a NGS sequencing readout: Genomic DNA-binding location in a ChIP determined by high-throughput sequencing, rather than hybridization to microarrays.

CLIP: a method that uses UV cross-linking to induce covalent attachment of distinct proteins to specific RNAs *in vivo*: RNAs that are protein bound can subsequently be purified from cell lysates by immunoprecipitation and subsequent sequencing. A recently developed variant of CLIP, termed PAR-CLIP uses photoactivable nucleotides to enhance cross-linking efficiency.

Clone: A large number of organisms, cells, or molecules that are identical with a single parental organism, cell, or molecule.

Copy number variation (CNV): Change in the copy number of specific genomic regions of DNA between two or more individuals. CNVs can be as large as 10^6 bp of DNA and as small as a few bp. CNVs also include insertions or deletions (indels).

Cosmid: A plasmid into which the DNA sequences from bacteriophage lambda that are necessary for the packaging of DNA (λ *cos* sites) have been inserted; this permits the plasmid DNA to be packaged *in vitro*.

CRISPER/Cas9: A prokaryotic “immune system” conferring resistance to

external genes from bacteriophage. This system provides a bacterial version of acquired immunity. CRISPR (clustered regularly interspaced short palindromic repeats) spacer-derived RNA combines with the Cas9 nuclease to target and specifically cleave the DNA of invading phage, thereby inactivating these invading genomes. This effectively protects the bacterium from productive phage infection and lysis. A variant of CRISPR-Cas9 that utilizes related proteins and guide RNAs to target specific RNAs for degradation is catalyzed by the C2c2 bacterial system.

ENCODE project: Encyclopedia of DNA elements project; an effort of multiple laboratories throughout the world to provide a detailed, biochemically informative representation of the human genome using high-throughput sequencing methods to identify and catalog the functional elements within the human genome. modENCODE is a parallel initiative to perform similar analyses on model organisms (yeasts, worms, flies, etc.).

Endonuclease: An enzyme that cleaves internal bonds in DNA or RNA.

Epigenetic code: The patterns of modification of chromosomal DNA (ie, cytosine methylation) and nucleosomal histone posttranslational modifications. These changes in modification status can lead to dramatic alterations in gene expression. Notably though, the actual underlying DNA sequence involved does not change.

Excinuclease: The excision nuclease involved in nucleotide exchange repair of DNA.

Exome: The nucleotide sequence of the entire complement of mRNA exons expressed in a particular cell, tissue, organ, or organism. The exome differs from the transcriptome that represents the entire collection of genome transcripts.

Exon: The sequence of a gene that is represented (expressed) as mRNA (or other mature, fully processed RNA).

Exonuclease: An enzyme that cleaves nucleotides from either the 3' or 5' ends of DNA or RNA.

Fingerprinting: The use of RFLPs or repeat sequence DNA to establish a unique pattern of DNA fragments for an individual.

FISH: Fluorescence in situ hybridization, a method used to map the location of specific DNA sequences within fixed nuclei.

Footprinting: DNA (or RNA; see Ribosome profiling below) with protein bound is resistant to digestion by DNase (or RNase) enzymes. When a sequencing reaction is performed using such DNA (or RNA), a

protected area, representing the “footprint” of the bound protein, will be detected because nucleases are unable to cleave the DNA (or RNA) directly bound by the protein.

Hairpin: A double-helical stretch formed by base pairing between neighboring complementary sequences of a single strand of DNA or RNA.

Hybridization: The specific reassociation of complementary strands of nucleic acids (DNA with DNA, DNA with RNA, or RNA with RNA).

Insert: An additional length of base pairs in DNA, generally introduced by the techniques of recombinant DNA technology.

Intron: The sequence of an mRNA-encoding gene that is transcribed but excised before translation. tRNA genes can also contain introns.

Library: A collection of cloned fragments that represents, in aggregate, the entire genome. Libraries may be either genomic DNA (in which both introns and exons are represented) or cDNA (in which only exons are represented).

Ligation: The enzyme-catalyzed joining in phosphodiester linkage of two stretches of DNA or RNA into one; the respective enzymes are DNA and RNA ligases.

LINES: Long interspersed repeat sequences.

Microsatellite polymorphism: Heterozygosity of a certain microsatellite repeat in an individual.

Microsatellite repeat sequences: Dispersed or group repeat sequences of 2 to 5 bp repeated up to 50 times. May occur at 50 to 100 thousand locations in the genome.

miRNAs: MicroRNAs, 21 to 22 nucleotide long RNA species derived primarily from RNA polymerase II transcription units, via RNA processing. These RNAs play crucial roles in gene regulation by altering mRNA function.

NET-seq, native elongating sequencing: Genome-wide analysis of eukaryotic mRNA nascent chain 3' ends mapped at nucleotide-level resolution. RNA polymerase II elongation complexes are captured by immunopurification with anti-Pol II antibodies and nascent RNAs containing a free 3' OH group are tagged via ligation with an RNA linker and subsequently amplified by PCR and subjected to NGS sequencing.

Nick translation: A technique for labeling DNA based on the ability of the DNA polymerase I from *E. coli* to degrade a strand of DNA that has been nicked and then to resynthesize the strand; if a radioactive

nucleoside triphosphate is employed, the resynthesized strand becomes labeled and can be used as a radioactive probe.

Northern blot: A method for transferring RNA from an agarose or polyacrylamide gel to a nitrocellulose or nylon filter, upon which the RNA can be detected by a suitable probe by base-specific hybridization.

Oligonucleotide: A short, defined sequence of nucleotides joined together in the typical phosphodiester linkage.

Ori: The origin of DNA replication.

PAC: A high-capacity (70-95 kb) cloning vector based on the lytic *E. coli* bacteriophage P1 that replicates in bacteria as an extrachromosomal element.

Palindrome: A sequence of duplex DNA that is the same when the two strands are read in opposite directions.

Plasmid: A small, extrachromosomal, circular molecule of DNA, or episome, that replicates independently of the host DNA.

Polymerase chain reaction (PCR): An enzymatic method for the repeated copying (and thus amplification) of the two strands of DNA that make up a particular gene sequence.

Primosome: The mobile complex of helicase and primase that is involved in DNA replication.

Probe: A molecule used to detect the presence of a specific fragment of DNA or RNA in, for instance, a bacterial colony that is formed from a genetic library or during analysis by blot transfer techniques; common probes are cDNA molecules, synthetic oligodeoxynucleotides of defined sequence, or antibodies to specific proteins.

PRO-Seq, precision run on sequencing: A method where nascent transcripts are specifically captured and sequenced using NGS sequencing techniques. This method allows for the mapping of the location of active transcription complexes genome-wide.

Proteome: The entire collection of expressed proteins in an organism.

Pseudogene: An inactive segment of DNA arising by mutation of a parental active gene; typically generated by transposition of a cDNA copy of an mRNA.

Recombinant DNA: The altered DNA that results from the insertion of a sequence of deoxynucleotides not previously present into an existing molecule of DNA by enzymatic or chemical means.

Restriction enzyme: A DNA endonuclease that causes cleavage of both strands of DNA at highly specific sites dictated by the base sequence.

- Reverse transcription:** RNA-directed synthesis of DNA catalyzed by reverse transcriptase.
- Ribosome profiling:** A variant of footprinting that allows isolation of small mRNA fragments protected from nuclease digestion by actively translating ribosomes. Allows for the quantitative estimation of the amount and rates of synthesis of the proteome of cells.
- RNA-Seq:** A method where cellular RNA populations are converted, via linker ligation and PCR into cDNAs that are then subjected to deep sequencing to determine the complete sequence of essentially all RNAs in the preparation.
- RIP:** An RNA immunoprecipitation method, performed like ChIP, which is used to score specific binding of a protein to a specific RNA in vivo. RIP uses formaldehyde cross-linking to induce covalent attachment of proteins to RNA (see also CLIP/PAR-CLIP).
- RT-PCR:** A method used to quantitate mRNA levels that relies on a first step of cDNA copying of mRNAs catalyzed by reverse transcriptase prior to PCR amplification and quantitation.
- Signal:** The end product observed when a specific sequence of DNA or RNA is detected by autoradiography or some other method. Hybridization with a complementary radioactive polynucleotide (eg, by Southern or Northern blotting) is commonly used to generate the signal.
- SINES:** Short interspersed repeat sequences.
- siRNAs:** Silencing RNAs, 21 to 25 nt in length generated by selective nucleolytic degradation of double-stranded RNAs of cellular or viral origin. siRNAs anneal to various specific sites within target in RNAs leading to mRNA degradation, hence gene “knockdown.”
- SNP:** Single-nucleotide polymorphism. Refers to the fact that single-nucleotide genetic variation in genome sequence exists at discrete loci throughout the chromosomes. Measurement of allelic SNP differences is useful for gene mapping studies.
- snRNA:** Small nuclear RNA. This family of RNAs is best known for its role in mRNA processing.
- Southern blot:** A method for transferring DNA from an agarose gel to nitrocellulose filter, on which the DNA can be detected by a suitable probe (eg, complementary DNA or RNA).
- Southwestern blot:** A method for detecting protein-DNA interactions by applying a labeled DNA probe to a transfer membrane that contains a renatured protein.
- Spliceosome:** The macromolecular complex responsible for precursor

mRNA splicing. The spliceosome consists of at least five small nuclear RNAs (snRNA; U1, U2, U4, U5, and U6) and many proteins.

Splicing: The removal of introns from RNA accompanied by the joining of its exons.

Sticky-ended DNA: Complementary single strands of DNA that protrude from opposite ends of a DNA duplex or from the ends of different duplex molecules (see also Blunt-ended DNA, above).

Tandem: Used to describe multiple copies of the same sequence (eg, DNA) that lie adjacent to one another.

Terminal transferase: An enzyme that adds nucleotides of one type (eg, deoxyadenonucleotidyl residues) to the 3' end of DNA strands.

Transcription: Template DNA-directed synthesis of nucleic acids, typically DNA-directed synthesis of RNA.

Transcriptome: The entire collection of expressed RNAs in a cell, tissue, organ, or organism; includes both mRNAs and ncRNAs.

Transgenic: Describing the introduction of new DNA into germ cells by its injection into the nucleus of the ovum.

Translation: Synthesis of protein using mRNA as template.

Vector: A plasmid or bacteriophage into which foreign DNA can be introduced for the purposes of cloning.

Western blot: A method for transferring protein to a nitrocellulose filter, on which the protein can be detected by a suitable probe (eg, an antibody).

Exam Questions

Section VII – Structure, Function, & Replication of Informational Macromolecules

1. Which of the following statements about β,γ -methylene and β,γ -imino derivatives of purine and pyrimidine triphosphates is CORRECT?
 - A. They are potential anticancer drugs.
 - B. They are precursors of B vitamins.

- C. They readily undergo hydrolytic removal of the terminal phosphate.
 - D. They can be used to implicate involvement of nucleotide triphosphates by effects other than phosphoryl transfer.
 - E. They serve as polynucleotide precursors.
2. Which of the following statements about nucleotide structures is NOT CORRECT?
- A. Nucleotides are polyfunctional acids.
 - B. Caffeine and theobromine differ structurally solely with respect to the number of methyl groups attached to their ring nitrogens.
 - C. A purine is a heterocyclic aromatic molecule composed of a pyrimidine ring fused to an imidazole ring.
 - D. NAD^+ , FMN, S-adenosylmethionine, and coenzyme A all are derivatives of ribonucleotides.
 - E. 3',5'-Cyclic AMP and 3',5'-cyclic GMP (cAMP and cGMP) serve as second messengers in human physiology.
3. Which of the following statements about purine nucleotide metabolism is NOT CORRECT?
- A. An early step in purine biosynthesis is the formation of PRPP (phosphoribosyl 1-pyrophosphate).
 - B. Inosine monophosphate (IMP) is a precursor of both AMP and GMP.
 - C. Orotic acid is an intermediate in pyrimidine nucleotide biosynthesis.
 - D. Humans catabolize uridine and pseudouridine by analogous reactions.
 - E. Ribonucleotide reductase converts nucleoside diphosphates to the corresponding deoxyribonucleoside diphosphates.
4. Which of the following statements is NOT CORRECT?
- A. Metabolic disorders are only infrequently associated with defects in the catabolism of purines.
 - B. Immune dysfunctions are associated both with a defective adenosine deaminase and with a defective purine nucleoside phosphorylase.
 - C. The Lesch-Nyhan syndrome reflects a defect in hypoxanthine-

- guanine phosphoribosyl transferase.
- D. Xanthine lithiasis can be due to a severe defect in xanthine oxidase.
 - E. Hyperuricemia can result from conditions such as cancer characterized by enhanced tissue turnover.
5. Which of the following components are found in DNA? **Choose the most complete answer.**
- A. A phosphate group, adenine, and ribose
 - B. A phosphate group, guanine, and deoxyribose
 - C. Cytosine and ribose
 - D. Thymine and deoxyribose
 - E. A phosphate group and adenine
6. The backbone of a DNA molecule consists of which of the following?
- A. Alternating sugars and nitrogenous bases
 - B. Nitrogenous bases alone
 - C. Phosphate groups alone
 - D. Alternating phosphate and sugar groups
 - E. Five carbon sugars alone
7. Which of the following is the interconnecting bond that connects the nucleotides of RNA and DNA ?
- A. *N*-glycosidic bonds
 - B. 3'-5' phosphodiester linkages
 - C. Phosphomonoesters
 - D. -2' phosphodiester linkages
 - E. Peptide nucleic acid bonds
8. Which component of the DNA duplex causes the molecule to have a net negative charge at physiologic pH?
- A. Deoxyribose
 - B. Ribose
 - C. Phosphate groups
 - D. Chlorine ion
 - E. Adenine

9. Which molecular feature listed causes duplex DNA to exhibit a near-constant width along its long axis?
- A. A purine nitrogenous base always pairs with another purine nitrogenous base.
 - B. A pyrimidine nitrogenous base always pairs with another pyrimidine nitrogenous base.
 - C. A pyrimidine nitrogenous base always pairs with a purine nitrogenous base.
 - D. Repulsion between phosphate groups keeps the strands a uniform distance apart.
 - E. Attraction between phosphate groups keeps the strands a uniform distance apart.
10. The model for DNA replication first proposed by Watson and Crick posited that every newly replicated double-stranded daughter duplex DNA molecule.
- A. Was composed of the two strands from the parent DNA molecule
 - B. Contained solely the two newly synthesized strands of DNA
 - C. Contained two strands that are random mixtures of new and old DNA within each strand
 - D. Was composed of one strand derived from the original parental DNA duplex and one strand that was newly synthesized
 - E. Was composed of nucleotide sequences completely distinct from either parental DNA strand
11. Name the mechanism through which RNAs are synthesized from DNA.
- A. Replicational duplication
 - B. Translation
 - C. Translesion repair
 - D. Transesterification
 - E. Transcription
12. Which of the forces or interactions listed below play the predominant role in driving RNA secondary and tertiary structure formation?
- A. Hydrophilic repulsion
 - B. Formation of complementary base pair regions

- C. Hydrophobic interaction
 - D. van der Waals interactions
 - E. Salt bridge formation
13. Name the enzyme that synthesizes RNA from a double-stranded DNA template.
- A. RNA-dependent RNA polymerase
 - B. DNA-dependent RNA convertase
 - C. RNA-dependent replicase
 - D. DNA-dependent RNA polymerase
 - E. Reverse transcriptase
14. Define the most notable characteristic difference with regard to gene expression between eukaryotes and prokaryotes.
- A. Ribosomal RNA nucleotide lengths
 - B. Mitochondria
 - C. Lysosomes and peroxisomes
 - D. Sequestration of the genomic material in the nucleus
 - E. Chlorophyll
15. Which entry below correctly describes the approximate number of bp of DNA_____, which is separated into _____chromosomes in atypical diploid human cell in a nonreplicating state?
- A. 64 billion, 23
 - B. 6.4 trillion, 46
 - C. 23 billion, 64
 - D. 64 billion, 46
 - E. 6.4 billion, 46
16. What is the approximate number of base pairs associated with a single nucleosome?
- A. 146
 - B. 292
 - C. 73
 - D. 1460
 - E. 900

17. All but one of the following histones are found located within the superhelix formed between DNA and the histone octamer; which of the following is this histone?
- A. Histone H2B
 - B. Histone H3
 - C. Histone H1
 - D. Histone H3
 - E. Histone H4
18. Chromatin can be broadly defined as active and repressed. Which of the following is termed as a subclass of chromatin that is specifically inactivated at certain times within an organism's life and/or in particular sets of differentiated cells?
- A. Constitutive euchromatin
 - B. Facultative heterochromatin
 - C. Euchromatin
 - D. Constitutive heterochromatin
19. Which of the following hypothesizes that the physical and functional status of a certain region of genomic chromatin is dependent on the patterns of specific histone posttranslational modifications (PTMs), and/or DNA methylation status?
- A. Morse code
 - B. PTM hypothesis
 - C. Nuclear body hypothesis
 - D. Epigenetic code
 - E. Genetic code
20. What is the name of the unusual repeated stretch of DNA localized at the tips of all eukaryotic chromosomes?
- A. Kinetochores
 - B. Telomere
 - C. Centriole
 - D. Chromomere
 - E. Micromere
21. Given that DNA polymerases are unable to synthesize DNA without a

- primer, what molecule serves as the primer for these enzymes during DNA replication?
- A. Five carbon sugars
 - B. Deoxyribose alone
 - C. A short RNA molecule
 - D. Proteins with free hydroxyl groups
 - E. Phosphomonoester
22. Which of the following terms is used for the discontinuous DNA replication that occurs during replication is catalyzed via the production of small DNA segments?
- A. Okazaki fragments
 - B. Toshihiro pieces
 - C. Onishi oligonucleotides
 - D. Crick strands
 - E. Watson fragments
23. What molecule or force supplies the energy that drives the relief of mechanical strain by DNA gyrase?
- A. Pyrimidine to purine conversion
 - B. Hydrolysis of GTP
 - C. Hydrolysis of ATP
 - D. Glycolysis
 - E. A proton gradient molecule or force
24. What is the name of the phase of the cell cycle between the conclusion of cell division and the beginning of DNA synthesis?
- A. G_1
 - B. S
 - C. G_2
 - D. M
 - E. G_0
25. At what stage of the cell cycle are key protein kinases, like cyclin-dependent kinase, activated?
- A. Right before mitosis

- B. At the beginning of S phase
 - C. Near the end of G₁ phase
 - D. At the end of the G₂ phase
 - E. All of the above
26. What disease is often associated with a breakdown of a cell's ability to regulate/control its own division?
- A. Kidney disease
 - B. Cancer
 - C. Emphysema
 - D. Diabetes
 - E. Heart disease
27. What is the molecular mechanism that is responsible for the quick decrease in the Cdk activity that leads to exit from the M phase and the entry into G₁?
- A. Drop in mitotic cyclin concentration
 - B. Decreased G₁ cyclin concentration
 - C. Rise in G₂ cyclin concentration
 - D. Rise in mitotic cyclin concentration
 - E. Rise in G₁ cyclin concentration
28. Which of the following is the site to which RNA polymerase binds on the DNA template prior to the initiation of transcription?
- A. Intron/exon junction
 - B. Open reading frame DNA
 - C. Terminator
 - D. Initiator methionine codon
 - E. Promoter
29. The large eukaryotic rRNA genes, such as 18S and 28S RNA-encoding genes, are transcribed by which of the following RNA polymerases?
- A. RNA polymerase III
 - B. RNA-dependent RNA polymerase δ
 - C. RNA polymerase I

- D. RNA polymerase II
 - E. Mitochondrial RNA polymerase
30. Eukaryotic RNA polymerases all have a requirement for a large variety of accessory proteins to enable them to bind promoters and form physiologically relevant transcription complexes. What are these proteins termed as?
- A. Basal or general transcription factors
 - B. Activators
 - C. Accessory factors
 - D. Elongation factors
 - E. Facilitator polypeptides
31. The DNA segment from which the primary transcript is copied or transcribed is called which of the following?
- A. Coding strand
 - B. Initiator methionine domain
 - C. Translation unit
 - D. Transcriptome
 - E. Initial codon
32. What class of DNA sequences are the eukaryotic genes that encode rRNAs?
- A. Single-copy DNA
 - B. Highly repetitive DNA
 - C. Moderately repetitive DNA
 - D. Mixed sequence DNA
33. How the modifications to the nucleotides of the pre-tRNAs, pre-rRNAs, and pre-mRNAs occur?
- A. Postprandially
 - B. Postmitotically
 - C. Pretranscriptionally
 - D. Posttranscriptionally
 - E. Prematurely
34. RNA polymerase II promoters are located on which side of the

transcription unit?

- A. Internal
 - B. 3' downstream
 - C. Nearest to the C-terminus
 - D. Nearest to the N-terminus
 - E. 5' upstream
35. With regard to eukaryotic mRNAs, which one of the following is not a normal property of mRNAs?
- A. Eukaryotic mRNAs have special modifications at their 5' (cap) and 3' (poly(A) tail) termini.
 - B. Are attached to ribosomes when they are translated.
 - C. They are found in the cytoplasm within peroxisomes.
 - D. Most have a significant noncoding segment that does not direct assembly of amino acids.
 - E. Contain continuous nucleotide sequences that encode a particular polypeptide.
36. Which of the following is the bond connecting the initiation nucleotide of the mRNA with the 5^{me}-G Cap structure?
- A. 3'-5' phosphodiester bridge
 - B. 5'-5' triphosphate bridge
 - C. 3'-3' triphosphate bridge
 - D. 3'-5' triphosphate bridge
 - E. 5'-3' triphosphate bridge
37. What sequence feature of mature mRNAs listed below is thought to protect mRNAs from degradation?
- A. Special posttranslational modifications
 - B. 3' Poly(C)_n tail
 - C. 5^{me}-G Cap
 - D. Introns
 - E. Lariat structures
38. What could the consequences of inaccurate mRNA splicing be for the RNA?

- A. A single base error at a splice junction will cause a large deletion.
 - B. A single base error at a splice junction will cause a large insertion.
 - C. A single base error at a splice junction will cause a large inversion.
 - D. C and E.
 - E. A single base error at a splice junction will change the reading frame and result in mRNA mistranslation.
39. What is the macromolecular complex that associates with introns during mRNA splicing?
- A. Splicer
 - B. Dicer
 - C. Nuclear body
 - D. Spliceosome
 - E. Slicer
40. What reaction does reverse transcriptase catalyze?
- A. Translation of RNA to DNA
 - B. Transcription of DNA to RNA
 - C. Conversion of ribonucleotides into deoxyribonucleotides
 - D. Transcription of RNA to DNA
 - E. Conversion of a ribonucleotide to deoxynucleotides in the DNA double helix
41. RNAi or dsRNA-mediated RNA interference mediates which of the following?
- A. RNA ligation
 - B. RNA silencing
 - C. RNA inversion
 - D. RNA restoration
 - E. RNA quelling
42. While the genetic code has 64 codons, there are only 20 naturally occurring amino acids. Consequently, some amino acids are encoded by more than one codon. This feature of the genetic code is an illustration of the genetic code being which of the following?
- A. Degenerative
 - B. Duplicative

- C. Nonoverlapping
 - D. Overlapping
 - E. Redundant
43. The genetic code contains how many termination codons?
- A. 3
 - B. 21
 - C. 61
 - D. 64
 - E. 20
44. If a tRNA has the sequence 5'-CAU-3', what codon would it recognize (ignore wobble base pairing).
- A. 3'-UAC-5'
 - B. 3'-AUG-5'
 - C. 5'-ATG-3'
 - D. 5'-AUC-3'
 - E. 5'-AUG-3'
45. What is on the 3' end of all functional, mature tRNAs?
- A. The cloverleaf loop
 - B. The anticodon
 - C. The sequence CCA
 - D. The codon
46. Most aminoacyl-tRNA synthetases possess an activity that is shared with DNA polymerases. This activity is a _____ function.
- A. Proofreading
 - B. Hydrogenase
 - C. Proteolytic
 - D. Helicase
 - E. Endonucleolytic
47. Which of the following is the CORRECT order for the three distinct phases of protein synthesis?
- A. Initiation, termination, elongation
 - B. Termination, initiation, elongation

- C. Initiation, elongation, termination
 - D. Elongation, initiation, termination
 - E. Elongation, termination, initiation
48. Which amino acid is the initiating amino acid for essentially all proteins?
- A. Cysteine
 - B. Threonine
 - C. Tryptophan
 - D. Methionine
 - E. Glutamic acid
49. The initiator tRNA is placed within the active 80S complex at which of the three-canonical ribosomal “sites” during protein synthesis?
- A. E site
 - B. I site
 - C. P site
 - D. A site
 - E. Releasing factor binding site
50. Name the enzyme that forms the peptide bond during protein synthesis and define its chemical composition.
- A. Pepsynthase, protein
 - B. Peptidyl transferase, RNA
 - C. Peptidase, glycolipid
 - D. Peptidyl transferase, protein
 - E. GTPase, glycopeptide
51. What is the term used for mutations in the middle of an open reading frame that create a stop codon?
- A. Frameshift mutation
 - B. Missense mutation
 - C. No-nonsense mutation
 - D. Point mutation
 - E. Nonsense mutation
52. What is the directionality of polypeptide synthesis?

- A. C-terminal to N-terminal direction
 - B. N-terminal to 3' direction
 - C. N-terminal to C-terminal direction
 - D. 3' to 5' direction
 - E. 5' to 3' direction
53. Which of the following *cis*-acting elements typically resides adjacent to or overlaps with many prokaryotic promoters?
- A. Regulatory gene
 - B. Structural gene(s)
 - C. Repressor
 - D. Operator
 - E. Terminator
54. What is the term applied to a segment of a bacterial chromosome where genes for the enzymes of a particular metabolic pathway are clustered and subject to coordinate control?
- A. Operon
 - B. Operator
 - C. Promoter
 - D. Terminal controller
 - E. Origin
55. What is the term applied to the complete collection of proteins present in a particular cell type?
- A. Genome
 - B. Peptide collection
 - C. Transcriptome
 - D. Translatome
 - E. Proteome
56. How does nucleosome formation on genomic DNA affect the initiation and/or elongation phases of transcription?
- A. Nucleosomes inhibit access of enzymes involved in all phases of transcription.
 - B. Nucleosomes recruit histone and DNA-modifying enzymes, and the actions of these recruited enzymes affect the access of

- transcription proteins to DNA.
- C. Nucleosomes induce DNA degradation where the DNA contacts the histones.
 - D. Nucleosomes have no significant effect on transcription.
57. Which types of molecules interact with eukaryotic mRNA gene core promoter sites to facilitate the association of RNA polymerase II?
- A. Termination factors
 - B. Sequence-specific transcription factors (transactivators)
 - C. Elongation factors
 - D. GTPases
 - E. General, or basal transcription factors (ie, the GTFs)
58. Most eukaryotic transcription factors contain at least two domains, each of which mediate different aspects of transcription factor function. Which of the following are these domains?
- A. RNA-binding domain and repression domain
 - B. Activation domain and repression domain
 - C. DNA-binding domain and activation domain
 - D. DNA-binding domain and ligand-binding domain
 - E. RNA-binding domain and the activation domain
59. Transcription factors bound at enhancers stimulate the initiation of transcription at the *cis*-linked core promoter through the action of intermediaries are termed as which of the following?
- A. Coactivators
 - B. Cotranscription proteins
 - C. Corepressors
 - D. Receptors
 - E. Coordinators
60. What reactions among transcription proteins greatly expand the diversity of regulatory factors that can be generated from a small number of polypeptides?
- A. Recombination
 - B. Homodimerization
 - C. Heterozygosity

- D. Heterodimerization
 - E. Trimerization
61. The gene region containing the TATA box and extending to the transcription start site (TSS) is often termed which of the following?
- A. Polymerase home
 - B. Initiator
 - C. Start selector
 - D. Core promoter
 - E. Operator
62. Which of the following possible mechanisms for how enhancers can stimulate transcription from great distances are currently thought to be CORRECT?
- A. Enhancers can reversibly excise the intervening DNA between enhancers and promoters.
 - B. RNA polymerase II binds avidly to enhancer sequences.
 - C. Enhancers unwind DNA.
 - D. Enhancers can search through DNA and bind directly to the associated core promoter.
 - E. Enhancers and core promoters are brought into close proximity through DNA loop formation mediated by DNA-binding proteins.
63. Which of the following histone amino acids are typically acetylated?
- A. Lysine
 - B. Arginine
 - C. Asparagine
 - D. Histidine
 - E. Leucine
64. Place the following steps in order; what are the steps that occur sequentially during a transcription activation event following the binding of a transcriptional activator to its cognate activator-binding site on genomic DNA.
1. The chromatin remodeling complex binds to the core histones at the target region.
 2. The combined actions of the various molecular complexes increase

promoter accessibility to the transcriptional machinery.

3. The activator recruits a coactivator to a region of chromatin targeted for transcription.
4. Transcriptional machinery assembles at the site where transcription will be initiated.
5. The coactivator acetylates the core histones of nearby nucleosomes.

- A. 1 – 2 – 3 – 4 – 5
- B. 3 – 1 – 5 – 2 – 4
- C. 3 – 5 – 1 – 2 – 4
- D. 5 – 3 – 1 – 2 – 4
- E. 3 – 5 – 1 – 4 – 2

65. What strategy in transcription factor research allows for the simultaneous identification of all of the genomic sites bound by a given transcription factor under a given set of physiologic conditions?

- A. Systematic deletion mapping
- B. DNase I sensitivity
- C. Chromatin immunoprecipitation-sequencing (ChIP-seq)
- D. FISH
- E. Fluorescence lifetime imaging microscopy

66. Which sequences extend between the 5'–methylguanosine cap present on eukaryotic mRNAs to the AUG initiation codon?

- A. Stop codon
- B. Last exon
- C. Last intron
- D. 3' UTR
- E. 5' UTR

67. Which of the following features of eukaryotic mRNA contribute importantly to message half-life?

- A. 5'–UTR sequences
- B. The promoter
- C. The operator
- D. 3' UTR and poly(A) tail

E. The first intron

*See glossary of terms at the end of this chapter.

SECTION

VIII

Biochemistry of Extracellular & Intracellular Communication

CHAPTER

40

Membranes: Structure & Function

P. Anthony Weil, PhD

OBJECTIVES

After studying this chapter, you should be able to:

- Know that biologic membranes are mainly composed of a lipid bilayer and associated proteins and glycoproteins. The major lipids are phospholipids, cholesterol, and glycosphingolipids.
- Appreciate that membranes are asymmetric, dynamic structures containing a mixture of integral and peripheral proteins.
- Describe the widely accepted fluid mosaic model of membrane

structure.

- Understand the concepts of passive diffusion, facilitated diffusion, active transport, endocytosis, and exocytosis.
- Recognize that transporters, ion channels, the $\text{Na}^+ - \text{K}^+$ -ATPase, receptors, and gap junctions are important participants in membrane function.
- Be aware that a variety of disorders result from abnormalities of membrane structure and function, including familial hypercholesterolemia, cystic fibrosis, hereditary spherocytosis, among others.

BIOMEDICAL IMPORTANCE

Membranes are dynamic, highly fluid structures consisting of a lipid bilayer and associated proteins. **Plasma membranes** form closed compartments around the cytoplasm to define cell boundaries. The plasma membrane has **selective permeabilities** and acts as a barrier, thereby maintaining differences in composition between the inside and outside of the cell. Selective membrane molecular permeability is generated through the action of specific **transporters** and **ion channels**. The plasma membrane also exchanges material with the extracellular environment by **exocytosis** and **endocytosis**, and there are special areas of membrane structure—**gap junctions**—through which adjacent cells may communicate by exchanging material. In addition, the plasma membrane plays key roles in **cell–cell interactions** and in **transmembrane signaling**.

Membranes also form **specialized compartments** within the cell. Such intracellular membranes help **shape** many of the morphologically distinguishable structures (organelles), for example, mitochondria, endoplasmic reticulum (ER), Golgi, secretory granules, lysosomes, and the nucleus. Membranes localize **enzymes**, function as integral elements in **excitation-response coupling**, and provide sites of **energy transduction**, such as in photosynthesis in plants (chloroplasts) and oxidative phosphorylation (mitochondria).

Changes in membrane components can affect water balance and ion flux, and therefore many processes within the cell. Specific deficiencies or alterations of certain membrane components (eg, caused by mutations in genes encoding membrane proteins) lead to a variety of **diseases** (see [Table 40–7](#)). In short, normal cellular function critically depends on normal membranes.

MAINTENANCE OF A NORMAL INTRA- & EXTRACELLULAR ENVIRONMENT IS FUNDAMENTAL TO LIFE

Life originated in an aqueous environment; enzyme reactions, cellular and subcellular processes have therefore evolved to work in this milieu, encapsulated within a cell.

The Body's Internal Water Is Compartmentalized

Water makes up about **60%** of the lean body mass of the human body and is distributed in two large compartments.

Intracellular Fluid (ICF)

This compartment constitutes **two-thirds** of total body water and provides a specialized environment for the cell to (1) make, store, and utilize energy; (2) to repair itself; (3) to replicate; and (4) to perform cell-specific functions.

Extracellular Fluid (ECF)

This compartment contains about **one-third** of total body water and is distributed between the plasma and interstitial compartments. The extracellular fluid is a **delivery system**. It brings to the cells nutrients (eg, glucose, fatty acids, and amino acids), oxygen, various ions and trace minerals, and a variety of regulatory molecules (hormones) that coordinate the functions of widely separated cells. Extracellular fluid **removes** CO₂, waste products, and toxic or detoxified materials from the immediate cellular environment.

The Ionic Compositions of Intracellular & Extracellular Fluids Differ Greatly

As illustrated in **Table 40–1**, the **internal environment** is rich in K⁺ and Mg²⁺, and phosphate is its major inorganic anion. The cytosol of cells contains a high concentration of protein that acts as a major intracellular buffer. **Extracellular fluid** is characterized by high Na⁺ and Ca²⁺ content, and Cl⁻ is the major anion. These ionic differences are maintained due to various membranes found in cells. These membranes have unique lipid

and protein compositions. A fraction of the protein constituents of membrane proteins are specialized to generate and maintain the differential ionic compositions of the extra- and intracellular compartments.

TABLE 40–1 Comparison of the Mean Concentrations of Various Molecules Outside and Inside a Mammalian Cell

Substance	Extracellular Fluid	Intracellular Fluid
Na ⁺	140 mmol/L	10 mmol/L
K ⁺	4 mmol/L	140 mmol/L
Ca ²⁺ (free)	2.5 mmol/L	0.1 μmol/L
Mg ²⁺	1.5 mmol/L	30 mmol/L
Cl ⁻	100 mmol/L	4 mmol/L
HCO ₃ ⁻	27 mmol/L	10 mmol/L
PO ₄ ³⁻	2 mmol/L	60 mmol/L
Glucose	5.5 mmol/L	0-1 mmol/L
Protein	2 g/dL	16 g/dL

MEMBRANES ARE COMPLEX STRUCTURES COMPOSED OF LIPIDS, PROTEINS, & CARBOHYDRATE-CONTAINING MOLECULES

We shall mainly discuss the membranes present in eukaryotic cells, although many of the principles described also apply to the membranes of prokaryotes. The various cellular membranes have different lipid and protein compositions. The ratio of protein to lipid in different membranes is presented in **Figure 40–1**, and is responsible for the many divergent functions of cellular organelles. Membranes are sheet-like enclosed structures consisting of an asymmetric lipid bilayer with distinct inner and outer surfaces or leaflets. These structures and surfaces are protein-studded, sheet-like, noncovalent assemblies that form spontaneously in aqueous environments due to the amphipathic nature of lipids and the proteins contained within the membrane.

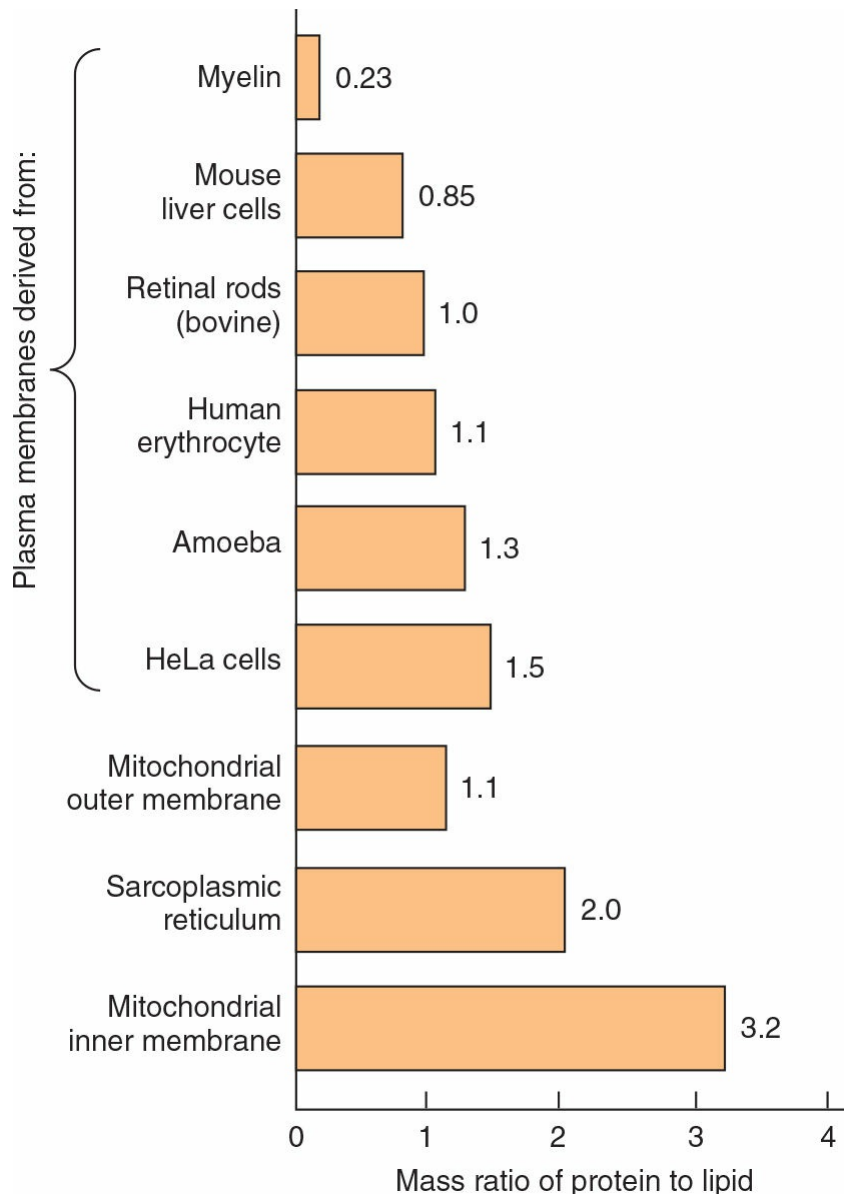

FIGURE 40–1 Membrane protein content is highly variable. The amount of proteins equals or exceeds the quantity of lipid in nearly all membranes. The outstanding exception is myelin, an electrical insulator found on many nerve fibers.

The Major Lipids in Mammalian Membranes Are Phospholipids, Glycosphingolipids & Cholesterol

Phospholipids

Of the two major phospholipid classes present in membranes, **phosphoglycerides** are the more common and consist of a glycerol-phosphate backbone to which are attached two fatty acids in ester linkages and an alcohol (**Figure 40–2**). The **fatty acid** constituents are usually

even-numbered carbon molecules, most commonly containing 16 or 18 carbons. They are unbranched and can be saturated or unsaturated with one or more double bonds. The simplest phosphoglyceride is **phosphatidic acid**, a 1,2-diacylglycerol 3-phosphate, a key intermediate in the formation of other phosphoglycerides (see [Chapter 24](#)). In most phosphoglycerides present in membranes, the 3-phosphate is esterified to an **alcohol** such as choline, ethanolamine, glycerol, inositol, or serine (see [Chapter 21](#)). Phosphatidylcholine is generally the major phosphoglyceride by mass in the membranes of human cells.

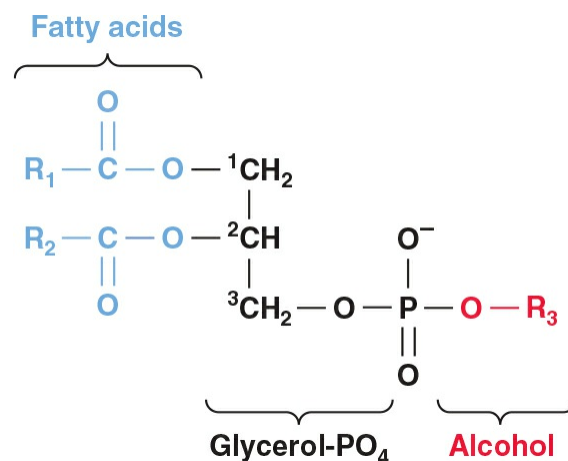

FIGURE 40–2 A phosphoglyceride showing the fatty acids (R_1 and R_2), glycerol, and a phosphorylated alcohol component. Saturated fatty acids are usually attached to carbon 1 of glycerol, and unsaturated fatty acids to carbon 2. In phosphatidic acid, R_3 is hydrogen.

The second major class of phospholipids comprises **sphingomyelin** (see [Figure 21–11](#)), a phospholipid that contains a sphingosine rather than a glycerol backbone. A fatty acid is attached by an amide linkage to the amino group of sphingosine, forming **ceramide**. When the primary hydroxyl group of sphingosine is esterified to phosphorylcholine, sphingomyelin is formed. As the name suggests, sphingomyelin is prominent in myelin sheaths.

Glycosphingolipids

The **glycosphingolipids (GSLs)** are sugar-containing lipids built on a backbone of **ceramide**. GSLs include **galactosyl-** and **glucosyl-ceramides** (cerebrosides) and the **gangliosides** (see structures in [Chapter 21](#)), and are mainly located in the plasma membranes of cells, displaying their sugar components to the exterior of the cell.

Sterols

The most common sterol in the membranes of animal cells is **cholesterol** (see [Chapter 21](#)). The majority of cholesterol resides within **plasma membranes**, but smaller amounts are found within mitochondrial, Golgi complex, and nuclear membranes. Cholesterol intercalates among the phospholipids of the membrane, with its hydrophilic hydroxyl group at the aqueous interface and the remainder of the molecule buried within the lipid bilayer leaflet. From a nutritional viewpoint, it is important to know that cholesterol is not present in plants.

Lipids can be separated from one another and quantified by techniques such as column, thin-layer, and gas-liquid chromatography and their structures established by mass spectrometry and other techniques (see [Chapter 4](#)).

Membrane Lipids Are Amphipathic

All major lipids in membranes contain both hydrophobic and hydrophilic regions and are therefore termed **amphipathic**. If the hydrophobic region were separated from the rest of the molecule, it would be insoluble in water but soluble in organic solvents. Conversely, if the hydrophilic region were separated from the rest of the molecule, it would be insoluble in organic solvents but soluble in water. The amphipathic nature of a phospholipid is represented in [Figure 40–3](#) and also [Figure 21–24](#). Thus, the **polar head groups** of the phospholipids and the hydroxyl group of cholesterol interface with the aqueous environment; a similar situation applies to the **sugar moieties** of the GSLs (see below).

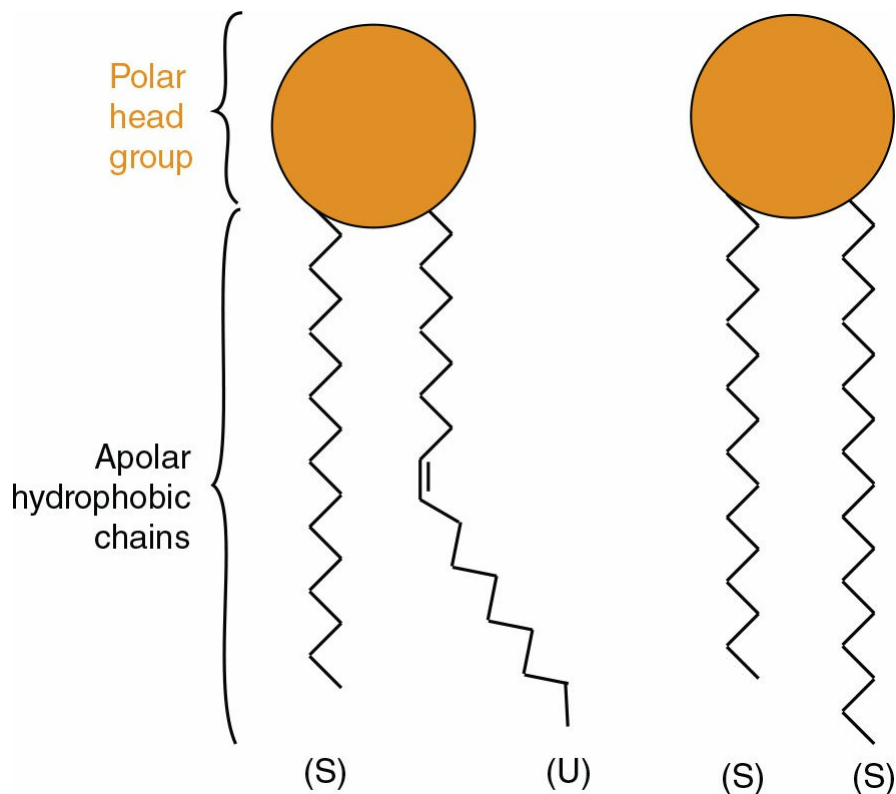

FIGURE 40–3 Diagrammatic representation of a phospholipid or other membrane lipid. The polar head group is hydrophilic, and the hydrocarbon tails are hydrophobic or lipophilic. The fatty acids in the tails are saturated (**S**) or unsaturated (**U**); the former is usually attached to carbon 1 of glycerol and the latter to carbon 2 (see [Figure 40–2](#)). Note the kink in the tail of the unsaturated fatty acid (**U**), which is important in conferring increased membrane fluidity.

The **S-U** phospholipid on the left contains the C_{16} saturated lipid palmitic acid, and the monounsaturated C_{18} lipid *cis*-oleic acid; both are esterified to glycerol (see [Figure 40-2](#)). The **S-S** phospholipid schematized on the right contains the C_{16} saturated lipid palmitic acid and the saturated C_{18} lipid, stearic acid.

Saturated fatty acids form relatively straight tails, whereas unsaturated fatty acids, which generally exist in the *cis* form in membranes, form “kinked” tails ([Figure 40–3](#); see also [Figures 21–1, 21–6](#)). As the number of double bonds within the lipid side chains increases, the number of kinks in the tails increases. As a consequence, the membrane lipids become less tightly packed and the membrane more fluid. The problem caused by the presence of **trans fatty acids** in membrane lipids is described in [Chapter 21](#).

Detergents are amphipathic molecules that are important in biochemistry as well as in the household. The molecular structure of a detergent is not unlike that of a phospholipid. Certain detergents are widely used to **solubilize** and purify membrane proteins. The hydrophobic end of the detergent binds to hydrophobic regions of the proteins, displacing most of their bound lipids. The polar end of the detergent is free, bringing the proteins into solution as detergent-protein complexes, usually also containing some residual lipids.

Membrane Lipids Form Bilayers

The amphipathic character of phospholipids suggests that the two regions of the molecule have incompatible solubilities. However, in a solvent such as water, phospholipids spontaneously organize themselves into **micelles** (Figure 40–4 and Figure 21–24), an assembly that thermodynamically satisfies the solubility requirements of the two chemically distinct regions of these molecules. Within the micelle the hydrophobic regions of the amphipathic phospholipids are shielded from water, while the hydrophilic polar groups are immersed in the aqueous environment. Micelles are usually relatively small in size (eg, ~200 nm) and consequently are limited in their potential to form membranes. Detergents commonly form micelles.

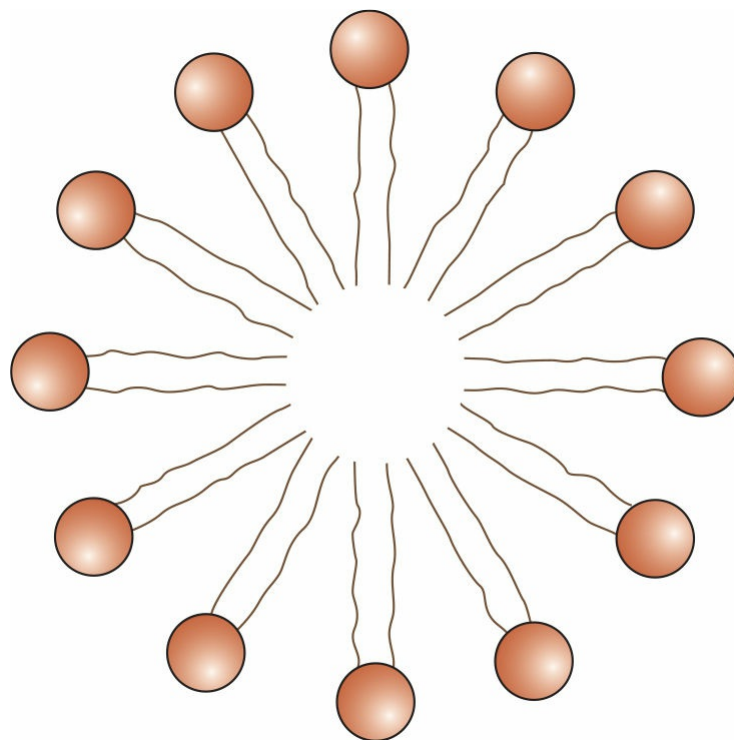

FIGURE 40–4 Diagrammatic cross-section of a micelle. The polar head groups are bathed in water, whereas the hydrophobic hydrocarbon tails are

surrounded by other hydrocarbons and thereby protected from water. Micelles are relatively small (compared with lipid bilayers) spherical structures.

Phospholipids and similar amphipathic molecules can form another structure, the **bimolecular lipid bilayer**, which also satisfies the thermodynamic requirements of amphipathic molecules in an aqueous environment. Bilayers are the key structures in biologic membranes. Bilayers exist as sheets wherein the hydrophobic regions of the phospholipids are sequestered from the aqueous environment, while the hydrophilic, charged portions are exposed to water (**Figure 40–5** and **Figure 21–24**). The ends or edges of the bilayer sheet can be eliminated by folding the sheet back on itself to form an enclosed vesicle with no edges. The closed bilayer provides one of the most essential properties of membranes. The lipid bilayer is **impermeable to most water-soluble molecules** since such charged molecules would be insoluble in the hydrophobic core of the bilayer. The **self-assembly of lipid bilayers** is driven by the **hydrophobic effect**, which describes the tendency of nonpolar molecules to self-associate in an aqueous environment, while in the process excluding H₂O. When lipid molecules come together in a bilayer, the entropy of the surrounding solvent molecules increases due to the release of immobilized water.

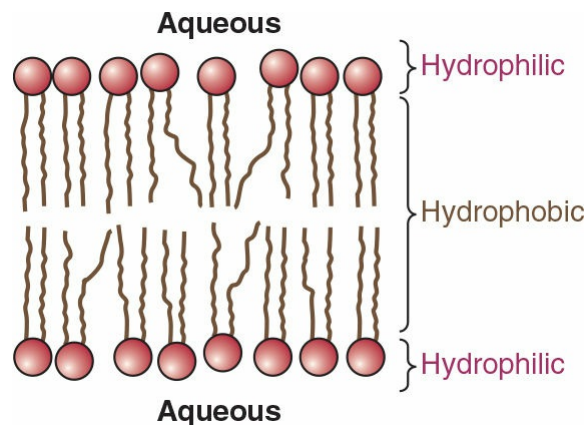

FIGURE 40–5 Diagram of a section of a bilayer membrane formed from phospholipids. The unsaturated fatty acid tails are kinked and lead to more spacing between the polar head groups, and hence to more room for movement. This in turn results in increased membrane fluidity.

Two questions arise from consideration of the information described above. First, how many biologically important molecules are **lipid-soluble**

and can therefore readily enter the cell? Gases such as oxygen, CO₂, and nitrogen—small molecules with little interaction with solvents—readily diffuse through the hydrophobic regions of the membrane. The **permeability coefficients** of several ions and a number of other molecules in a lipid bilayer are shown in **Figure 40–6**. The electrolytes Na⁺, K⁺, and Cl[−] cross the bilayer much more slowly than water. In general, the permeability coefficients of small molecules in a lipid bilayer **correlate with their solubilities in nonpolar solvents**. For instance, **steroids** more readily traverse the lipid bilayer compared with electrolytes. The high permeability coefficient of **water** itself is surprising, but is partly explained by its small size and relative lack of charge. Many **drugs** are hydrophobic and can readily cross membranes and enter cells.

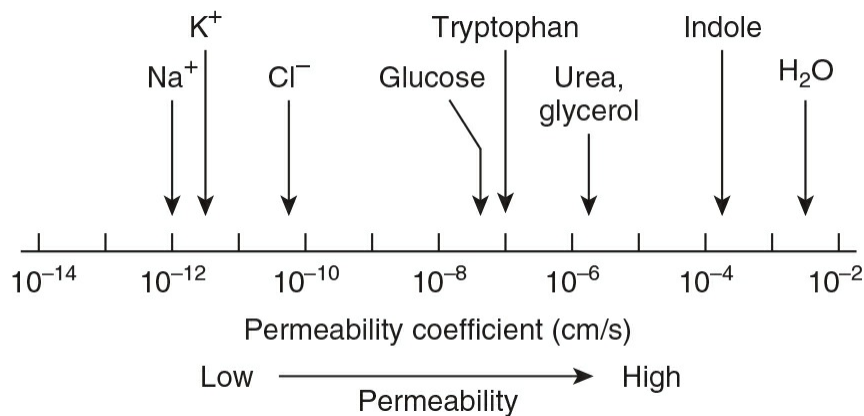

FIGURE 40–6 Permeability coefficients of water, some ions, and other small molecules in lipid bilayer membranes. The permeability coefficient is a measure of the ability of a molecule to diffuse across a permeability barrier. Molecules that move rapidly through a given membrane are said to have a high permeability coefficient.

The second question concerns **non-lipid-soluble molecules**. How are the transmembrane concentration gradients for these molecules maintained? The answer is that **membranes contain proteins**, many of which span the lipid bilayer. These proteins either form **channels** for the movement of ions and small molecules or serve as **transporters** for molecules that otherwise could not readily traverse the lipid bilayer (membrane). The nature, properties, and structures of membrane channels and transporters are described below.

Membrane Proteins Are Associated With the Lipid

Bilayer

Membrane **phospholipids** act as a solvent for membrane proteins, creating an environment in which the latter can function. As described in [Chapter 5](#), the **α -helical structure of proteins** minimizes the hydrophilic character of the peptide bonds themselves. Thus, proteins can be amphipathic and form an integral part of the membrane by having hydrophilic regions protruding at the inside and outside faces of the membrane but connected by a hydrophobic region traversing the hydrophobic core of the bilayer. In fact, those portions of membrane proteins that traverse membranes do contain substantial numbers of hydrophobic amino acids and almost invariably have a high α -helical content. For most membranes, a stretch of ~ 20 amino acids in an α -helical configuration will span the lipid bilayer (see [Figure 5-2](#)).

It is possible to calculate whether a particular sequence of amino acids present in a protein is consistent with a **transmembrane location**. This can be done by consulting a table that lists the hydrophobicities of each of the 20 common amino acids and the free energy values for their transfer from the interior of a membrane to water. Hydrophobic amino acids have positive values; polar amino acids have negative values. The total free energy values for transferring successive sequences of 20 amino acids in the protein are plotted, yielding a so-called **hydropathy plot**. Values of over 20 kcal mol^{-1} are consistent with—but do not prove—the interpretation that the hydrophobic sequence is a transmembrane segment.

Another aspect of the interaction of lipids and proteins is that some proteins are anchored to one leaflet of the bilayer by covalent linkages to certain lipids; this process is termed **protein lipidation**. Lipidation can occur at protein termini (N- or C-) or internally. Common protein lipidation events are C-terminal protein **isoprenylation**, **cholesterylation**, and **glycophosphatidylinositol (GPI)**; see [Figure 46-1](#)); N-terminal protein **myristoylation** and internal cysteine **S-prenylation** and **S-acylation**. Such lipidation only occurs on a specific subset of proteins and typically plays key roles in their biology.

Different Membranes Have Different Protein Compositions

The **number of different proteins** in a membrane varies from less than a dozen very abundant proteins in the sarcoplasmic reticulum of muscle cells to hundreds in plasma membranes. Proteins are the **major functional**

molecules of membranes and consist of **enzymes, pumps and transporters, channels, structural components, antigens** (eg, for histocompatibility), and **receptors** for various molecules. Because every type of membrane possesses a different complement of proteins, there is no such thing as a typical membrane structure. The enzymes associated with several different membranes are shown in **Table 40–2**.

TABLE 40–2 Enzymatic Markers of Different Membranes^a

Membrane	Enzyme
Plasma	5'-Nucleotidase Adenylyl cyclase Na ⁺ -K ⁺ -ATPase
Endoplasmic reticulum	Glucose-6-phosphatase
Golgi apparatus	
<i>Cis</i>	GlcNAc transferase I
Medial	Golgi mannosidase II
<i>Trans</i>	Galactosyl transferase
<i>Trans</i> Golgi network	Sialyltransferase
Inner mitochondrial membrane	ATP synthase

^aMembranes contain many proteins, some of which have enzymatic activity. Some of these enzymes are located only in certain membranes and can therefore be used as markers to follow the purification of these membranes.

Membranes Are Dynamic Structures

Membranes and their components are dynamic structures. Membrane lipids and proteins undergo turnover, just as they do in other compartments of the cell. Different lipids have different turnover rates, and the turnover rates of individual species of membrane proteins may vary widely. In some instances, the membrane itself can turn over even more rapidly than any of its constituents. This is discussed in more detail in the section on endocytosis.

Another indicator of the dynamic nature of membranes is that a variety of studies have shown that lipids and certain proteins exhibit **lateral diffusion** in the plane of their membranes. Many nonmobile proteins do not exhibit lateral diffusion because they are anchored to the underlying

actin cytoskeleton. By contrast, the **transverse** movement of lipids across the membrane (**flip-flop**) is extremely slow (see below), and does not appear to occur at an appreciable rate in the case of membrane proteins.

Membranes Are Asymmetric Structures

Proteins have unique orientations in membranes, making the **outside surfaces different from the inside surfaces**. An **inside-outside asymmetry** is also provided by the external location of the carbohydrates attached to membrane proteins. In addition, specific proteins are located exclusively on the outsides or insides of membranes.

There are also **regional heterogeneities** in membranes. Some, such as occur at the villous borders of mucosal cells, are almost macroscopically visible. Others, such as those at gap junctions, tight junctions, and synapses, occupy much smaller regions of the membrane and generate correspondingly smaller local asymmetries.

There is also inside-outside **asymmetry of the phospholipids**. The **choline-containing phospholipids** (phosphatidylcholine and sphingomyelin) are located mainly in the **outer leaflet**; the **aminophospholipids** (phosphatidylserine and phosphatidylethanolamine) are preferentially located in the **inner leaflet**. Obviously, if this **lipid asymmetry** is to exist at all, there must be **limited transverse mobility**, or 'flip-flop' the membrane phospholipids. In fact, phospholipids in synthetic bilayers exhibit an extraordinarily slow rate of flip-flop; the half-life of the asymmetry in these synthetic bilayers is on the order of several weeks.

The mechanisms involved in the lipid asymmetry are not well understood. The enzymes involved in the synthesis of phospholipids are located on the cytoplasmic side of microsomal membrane vesicles. Translocases (**flippases**) exist that transfer certain phospholipids (eg, phosphatidylcholine) from the inner to the outer leaflet. Specific proteins that preferentially bind individual phospholipids also appear to be present in the two leaflets; thus, lipid binding also contributes to the asymmetric distribution of specific lipid molecules. In addition, **phospholipid exchange proteins** recognize certain phospholipids and transfer them from one membrane (eg, the **ER**) to others (eg, mitochondrial and peroxisomal). A related issue is how lipids enter membranes. This has not been studied as intensively as the topic of how proteins enter membranes (see [Chapter 49](#)) and knowledge is still relatively meager. Many membrane lipids are synthesized in the ER. At least three pathways have been recognized: (1) transport from the ER in vesicles, which then transfer the contained lipids

to the recipient membrane; (2) entry via direct contact of one membrane (eg, the ER) with another, facilitated by specific proteins; and (3) transport via the phospholipid exchange proteins (also known as lipid transfer proteins) mentioned above, which only exchanges lipids, but does not cause net transfer.

There is further asymmetry with regard to glycosphingolipids and **glycoproteins**; the sugar moieties of these molecules all protrude outward from the plasma membrane and are absent from its inner face.

Membranes Contain Integral & Peripheral Proteins

It is useful to classify membrane proteins into two types: **integral** and **peripheral** (**Figure 40–7**). Most membrane proteins fall into the **integral class**, meaning that they interact extensively with the phospholipids and **require the use of detergents** for their solubilization. Also, they generally span the bilayer as a bundle of α -helical transmembrane segments. Integral proteins are usually globular and are themselves amphipathic. They consist of two hydrophilic ends separated by an intervening hydrophobic region that traverses the hydrophobic core of the bilayer. As the structures of integral membrane proteins were being elucidated, it became apparent that certain ones (eg, transporter molecules, ion channels, various receptors, and G proteins) span the bilayer many times, whereas other simple membrane proteins (eg, glycophorin A) span the membrane only once (see **Figures 42–4** and **52–5**). Integral proteins are asymmetrically distributed across the membrane bilayer. This asymmetric orientation is conferred at the time of their insertion in the lipid bilayer during biosynthesis in the ER. The molecular mechanisms involved in insertion of proteins into membranes and the topic of membrane assembly are discussed in **Chapter 49**.

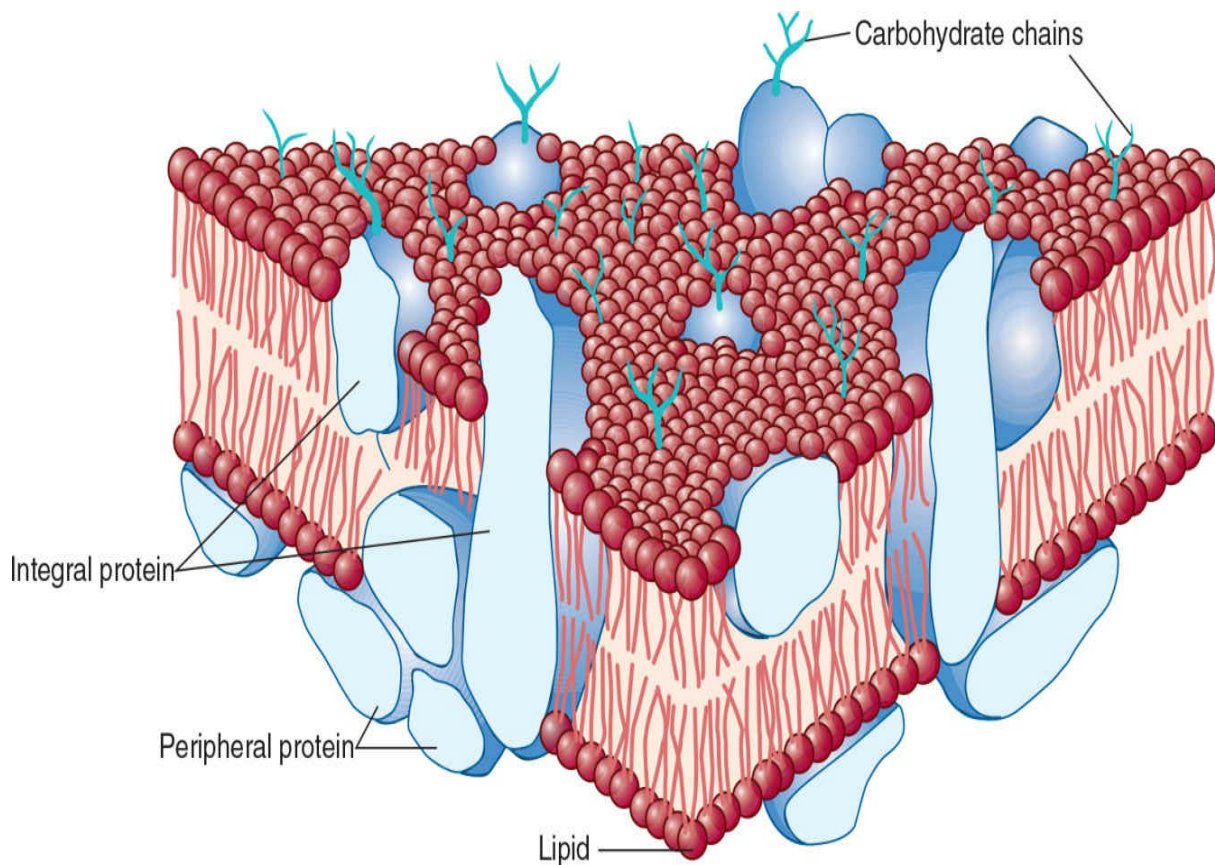

FIGURE 40–7 The fluid mosaic model of membrane structure. The membrane consists of a bimolecular lipid layer with proteins inserted in it or bound to either surface. Integral membrane proteins are firmly embedded in the lipid layers. Some of these proteins completely span the bilayer and are called transmembrane proteins, while others are embedded in either the outer or inner leaflet of the lipid bilayer. Loosely bound to the outer or inner surface of the membrane are the peripheral proteins. Many of the proteins and all the glycolipids have externally exposed oligosaccharide carbohydrate chains. (Reproduced, with permission, from Junqueira LC, Carneiro J: *Basic Histology: Text & Atlas*, 10th ed. McGraw-Hill, 2003.)

Peripheral proteins do not interact directly with the hydrophobic cores of the phospholipids in the bilayer and thus **do not require use of detergents** for their release. They are bound to the hydrophilic regions of specific integral proteins and head groups of phospholipids and can be released from them by treatment with salt solutions of high ionic strength. For example, ankyrin, a peripheral protein, is bound to the inner aspect of the integral protein “band 3” of the erythrocyte membrane. Spectrin, a cytoskeletal structure within the erythrocyte, is in turn bound to ankyrin and thereby plays an important role in maintenance of the biconcave shape

of the erythrocyte.

ARTIFICIAL MEMBRANES MODEL MEMBRANE FUNCTION

Artificial membrane systems can be prepared by appropriate techniques. These systems generally consist of mixtures of one or more phospholipids of natural or synthetic origin that have been treated by using **mild sonication** to induce the formation of spherical vesicles in which the lipids form a bilayer. Such vesicles, surrounded by a lipid bilayer with an aqueous interior, are termed **liposomes** (see [Figure 21–24](#)).

The advantages and uses of artificial membrane systems for the biochemical study of membrane function are as follows:

1. The **lipid content** of the membranes can be varied, allowing systematic examination of the effects of varying lipid composition on certain functions.
2. Purified **membrane proteins** or enzymes can be incorporated into these vesicles in order to assess what factors (eg, specific lipids or ancillary proteins) the proteins require to reconstitute their function.
3. The **environment** of these systems can be rigidly controlled and systematically varied (eg, ion concentrations and ligands).
4. When liposomes are formed, they can be made to **entrap** certain compounds within the vesicle such as drugs and isolated genes. There is interest in using liposomes to distribute drugs to certain tissues, and if components (eg, antibodies to certain cell surface molecules) could be incorporated into liposomes so that they would be targeted to specific tissues or tumors, the therapeutic impact would be considerable. DNA entrapped inside liposomes appears to be less sensitive to attack by nucleases; this approach may prove useful in attempts at **gene therapy**.

THE FLUID MOSAIC MODEL OF MEMBRANE STRUCTURE IS WIDELY ACCEPTED

The **fluid mosaic model** of membrane structure proposed in 1972 by Singer and Nicolson ([Figure 40–7](#)) is now widely accepted. The model is often likened to integral membrane protein “icebergs” floating in a sea of (predominantly) fluid phospholipid molecules. Early evidence for the

model was the finding that well characterized, fluorescently labeled integral membrane proteins could be seen microscopically to rapidly and randomly redistribute within the plasma membrane of a hybrid cell formed by the artificial fusion of two different (mouse and human) parent cells (one labeled the other not). It has subsequently been demonstrated that **phospholipids** undergo even more rapid lateral diffusion with subsequent redistribution within the plane of the membrane. Measurements indicate that within the plane of the membrane, one molecule of phospholipid can move several micrometers per second.

The **phase changes**—and thus the **fluidity** of membranes—are largely dependent on the lipid composition of the membrane. In a lipid bilayer, the hydrophobic chains of the fatty acids can be highly aligned or ordered to provide a rather stiff structure. As the temperature increases, the hydrophobic side chains undergo a **transition** from the **ordered state** (more gel-like or crystalline phase) to a **disordered** one, taking on a more liquid-like or fluid arrangement. The temperature at which membrane structure undergoes the transition from ordered to disordered (ie, melts) is called the “**transition temperature**” (T_m). Longer and more saturated fatty acid chains interact more strongly with each other via their extended hydrocarbon chains and thus cause higher values of T_m —that is, higher temperatures are required to increase the fluidity of the bilayer. On the other hand, **unsaturated bonds** that exist **in the *cis* configuration** tend to increase the fluidity of a bilayer by decreasing the compactness of the side chain packing without diminishing hydrophobicity (Figures 40–3 and 40–5). The phospholipids of cellular membranes generally contain at least one unsaturated fatty acid with at least one *cis* double bond.

Cholesterol acts as a buffer to modify the fluidity of membranes. At temperatures below the T_m , it interferes with the interaction of the hydrocarbon tails of fatty acids and thus increases fluidity. At temperatures above the T_m , it limits disorder because it is more rigid than the hydrocarbon tails of the fatty acids and cannot move in the membrane to the same extent, thus limiting, or “buffering” membrane fluidity.

The fluidity of a membrane significantly affects its functions. As membrane fluidity increases, so does its permeability to water and other small hydrophilic molecules. The lateral mobility of integral proteins increases as the fluidity of the membrane increases. If the active site of an integral protein involved in a given function is exclusively in its hydrophilic regions, changing lipid fluidity will probably have little effect on the activity of the protein; however, if the protein is involved in a

transport function in which transport components span the membrane, lipid-phase effects may significantly alter the transport rate. The insulin receptor (see [Figure 42–8](#)) is an excellent example of altered function with changes in fluidity. As the concentration of unsaturated fatty acids in the membrane is increased (by growing cultured cells in a medium rich in such molecules), fluidity increases. Increased fluidity alters the receptor such that it binds insulin more effectively. At normal body temperature (37°C), the lipid bilayer is in a fluid state. Underscoring the importance of membrane fluidity, it has been shown that bacteria can modify the composition of their membrane lipids to adapt to changes in temperature.

Lipid Rafts, Caveolae, & Tight Junctions Are Specialized Features of Plasma Membranes

Plasma membranes contain **certain specialized structures** whose biochemical natures have been investigated in some detail.

Lipid rafts are specialized areas of the **exoplasmic (outer) leaflet** of the lipid bilayer enriched in cholesterol, sphingolipids, and certain proteins ([Figure 40–8](#)). They have been hypothesized to be involved in signal transduction and other processes. It is thought that clustering certain components of signaling systems closely together may increase the efficiency of their function.

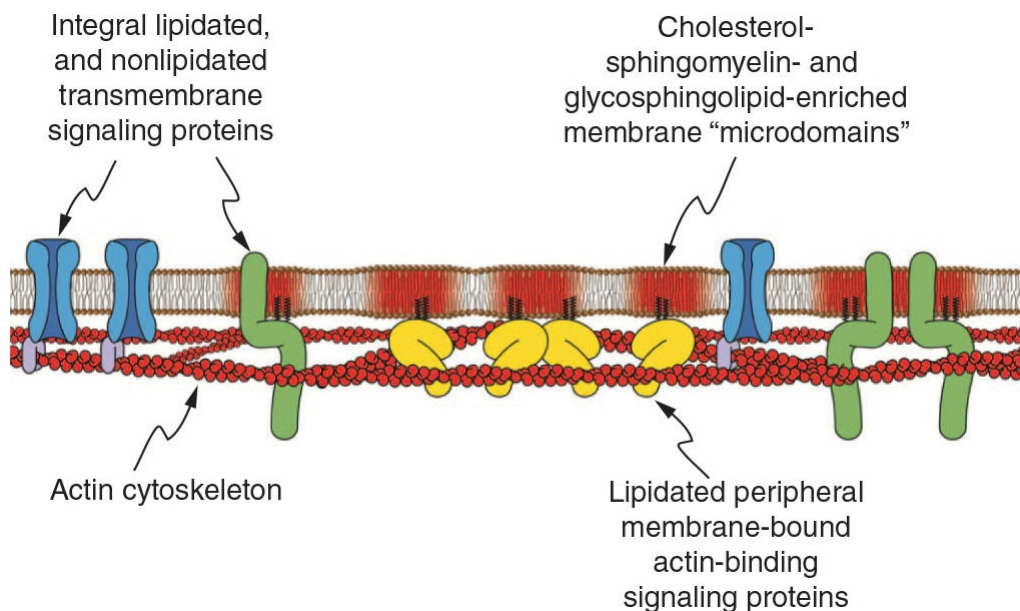

FIGURE 40–8 Schematic diagram of a lipid raft. Shown in schematic form are multiple lipid rafts (red membrane shading) that represent localized microdomains rich in the indicated lipids and signaling proteins

(blue, green, yellow). Lipid rafts are stabilized through interactions (direct and indirect) with the actin cytoskeleton (red bihelical chains; see [Figure 51–3](#)). (Figure modified from: The lipid raft hypothesis revisited—new insights on raft composition and function from super-resolution fluorescence microscopy. *Bioessays* 2012;34:739-747. Wiley Periodical, Inc. Copyright © 2012.)

Caveolae may derive from lipid rafts. Many, if not all, contain the protein **caveolin-1**, which may be involved in their formation from rafts. Caveolae are observable by electron microscopy as flask, or tube-shaped indentations of the cell membrane into the cytosol ([Figure 40–9](#)). Proteins detected in caveolae include various components of the signal transduction system (eg, the insulin receptor and some G proteins; see [Chapter 42](#)), the folate receptor, and endothelial nitric oxide synthase (eNOS). Caveolae and lipid rafts are active areas of research, and ideas concerning them and their roles in various biologic processes are rapidly evolving.

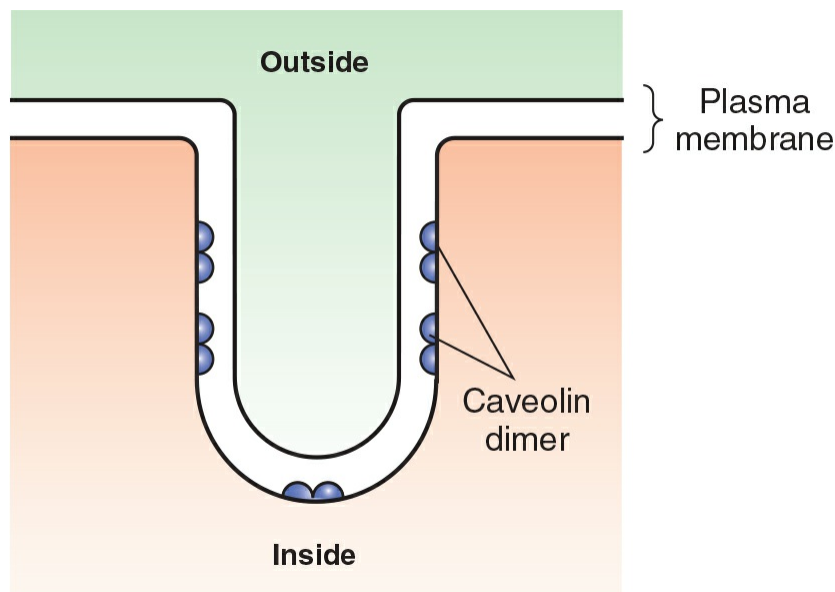

FIGURE 40–9 Schematic diagram of a caveola. A caveola is an invagination in the plasma membrane. The protein caveolin appears to play an important role in the formation of caveolae and occurs as a dimer. Each caveolin monomer is anchored to the inner leaflet of the plasma membrane by three palmitoyl molecules (not shown).

Tight junctions are other structures found in surface membranes. They are often located below the apical surfaces of epithelial cells and prevent the diffusion of macromolecules between cells. They are composed of various proteins, including occludin, various claudins, and junctional

adhesion molecules.

Yet other specialized structures found in surface membranes include **desmosomes**, **adherens junctions**, and **microvilli**; their chemical natures and functions are not discussed here. The nature of **gap junctions** is described below.

MEMBRANE SELECTIVITY ALLOWS ADJUSTMENTS OF CELL COMPOSITION & FUNCTION

If the plasma membrane is relatively impermeable, how do most molecules enter a cell? How is selectivity of this movement established? Answers to such questions are important in understanding how cells adjust to a constantly changing extracellular environment. Metazoan organisms also must have means of communicating between adjacent and distant cells, so that complex biologic processes can be coordinated. These signals must arrive at and be transmitted by the membrane, or they must be generated as a consequence of some interaction with the membrane. Some of the major mechanisms used to accomplish these different objectives are listed in **Table 40–3**.

TABLE 40–3 Transfer of Material and Information Across Membranes

Cross-membrane movement of small molecules

Diffusion (passive and facilitated)

Active transport

Cross-membrane movement of large molecules

Endocytosis

Exocytosis

Signal transmission across membranes

Cell surface receptors

1. Signal transduction (eg, glucagon → cAMP)
2. Signal internalization (coupled with endocytosis, eg, the LDL receptor)

Movement to intracellular receptors (steroid hormones; a form of diffusion)

Intercellular contact and communication

Passive (simple) diffusion is the flow of solute from a higher to a lower concentration due to random thermal movement

Facilitated diffusion is passive transport of a solute from a higher concentration to a lower concentration, mediated by a specific protein transporter

Active transport is transport of a solute across a membrane in the direction of increasing concentration, and thus requires energy (frequently derived from the hydrolysis of ATP); a specific transporter (pump) is involved

Extracellular microvesicle and exosome secretion and uptake

The other terms used in this table are explained later in this chapter or elsewhere in this text.

Passive Diffusion Involving Transporters & Ion Channels Moves Many Small Molecules Across Membranes

Molecules can **passively** traverse the bilayer down electrochemical gradients by **simple diffusion** or by **facilitated diffusion**. This spontaneous movement toward equilibrium contrasts with **active transport**, which **requires energy** because it constitutes movement against an electrochemical gradient. **Figure 40–10** provides a schematic

representation of these mechanisms.

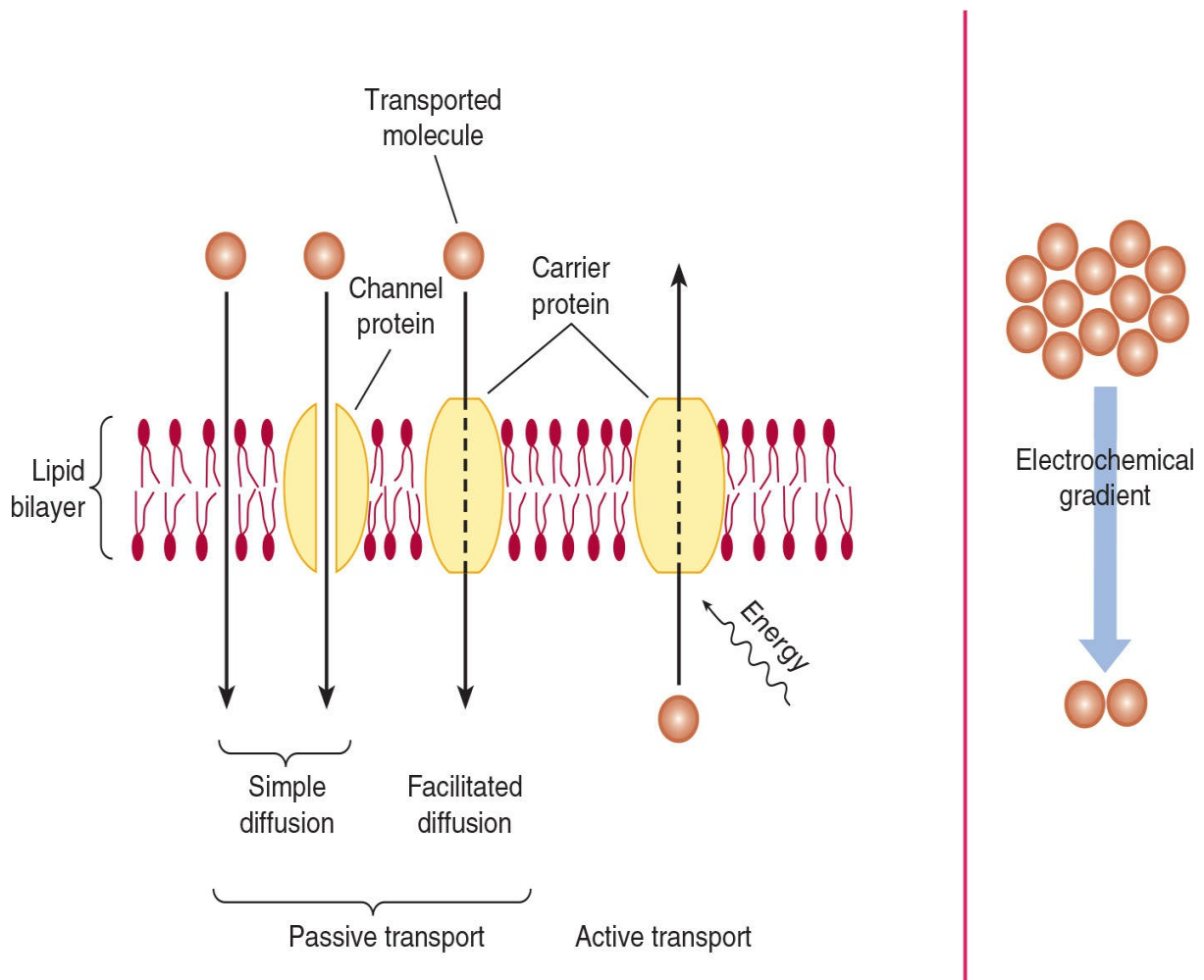

FIGURE 40–10 Many small, uncharged molecules pass freely through the lipid bilayer by simple diffusion. Larger uncharged molecules, and some small uncharged molecules, are transferred by specific carrier proteins (transporters) or through channels or pores. Passive transport is always down an electrochemical gradient (shown schematically, right), toward equilibrium. Active transport is against an electrochemical gradient and requires an input of energy, whereas passive transport does not. (Redrawn and reproduced, with permission, from Alberts B, et al: *Molecular Biology of the Cell*. Garland, 1983.)

Simple diffusion is the passive flow of a solute from a higher to a lower concentration due to random thermal movement. By contrast, **facilitated diffusion** is passive transport of a solute from a higher to a lower concentration mediated by a specific protein transporter. **Active transport** is vectorial movement of a solute across a membrane against a concentration gradient, and thus requires energy (frequently derived from

the hydrolysis of ATP); a specific transporter (**pump**) is involved.

As mentioned earlier in this chapter, some solutes such as gases can enter the cell by diffusing down an electrochemical gradient across the membrane and do not require metabolic energy. **Simple diffusion** of a solute across the membrane is limited by three factors: (1) the thermal agitation of that specific molecule; (2) the concentration gradient across the membrane; and (3) the solubility of that solute (the permeability coefficient, [Figure 40–6](#)) in the hydrophobic core of the membrane bilayer. Solubility is inversely proportional to the number of hydrogen bonds that must be broken in order for a solute in the external aqueous phase to become incorporated in the hydrophobic bilayer. Electrolytes, poorly soluble in lipid, do not form hydrogen bonds with water, but they do acquire a shell of water from hydration by electrostatic interaction. The size of the shell is directly proportional to the charge density of the electrolyte. Electrolytes with a large charge density have a larger shell of hydration and thus a slower diffusion rate. Na^+ , for example, has a higher charge density than K^+ . Hydrated Na^+ is therefore larger than hydrated K^+ ; hence, the latter tends to move more easily through the membrane.

The following affect **net diffusion** of a substance: (1) concentration gradient across the membrane—solute moves from high to low concentration; (2) electrical potential across the membrane: solutes move toward the solution that has the opposite charge. The inside of the cell usually has a net negative charge; (3) permeability coefficient of the substance for the membrane; (4) hydrostatic pressure gradient across the membrane: increased pressure will increase the rate and force of the collision between the molecules and the membrane; and (5) temperature, since increased temperature will increase particle motion and thus increase the frequency of collisions between external particles and the membrane.

Facilitated diffusion involves either certain transporters or ion channels ([Figure 40–11](#)). Active transport is mediated by other transporters most of which are ATP-driven. A multitude of transporters and channels exist in biologic membranes that route the entry of ions into and out of cells. [Table 40–4](#) summarizes some important differences between transporters and ion channels.

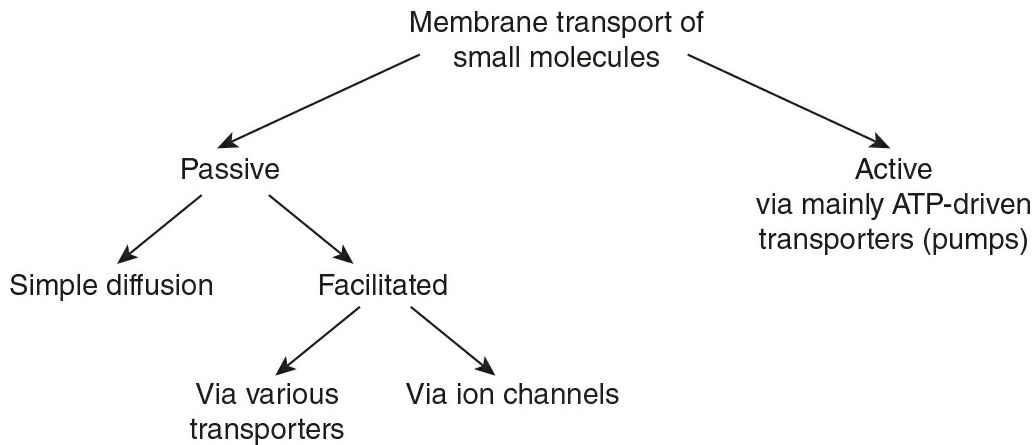

FIGURE 40–11 A schematic diagram of the two types of membrane transport of small molecules.

TABLE 40–4 Comparison of Transporters and Ion Channels

Transporters	Ion Channels
Bind solute and undergo conformational changes, transferring the solute across the membrane	Form pores in membranes
Involved in passive (facilitated diffusion) and active transport	Involved only in passive transport
Transport is significantly slower than via ion channels	Transport is significantly faster than via transporters

Note: Transporters are also known as carriers or permeases. Active transporters are often called pumps.

Transporters Are Specific Proteins Involved in Facilitated Diffusion & Also Active Transport

Transport systems can be described in a functional sense according to the number of molecules moved and the direction of movement (**Figure 40–12**) or according to whether movement is toward or away from equilibrium. The following **classification** depends primarily on the former. A **uniport** system moves one type of molecule bidirectionally. In **cotransport** systems, the transfer of one solute depends on the stoichiometric simultaneous or sequential transfer of another solute. A **symport** moves two solutes in the same direction. Examples are the proton-sugar transporter in bacteria and the Na^+ -sugar transporters (for

glucose and certain other sugars) and Na^+ -amino acid transporters in mammalian cells. **Antiport** systems move two molecules in opposite directions (eg, Na^+ in and Ca^{2+} out).

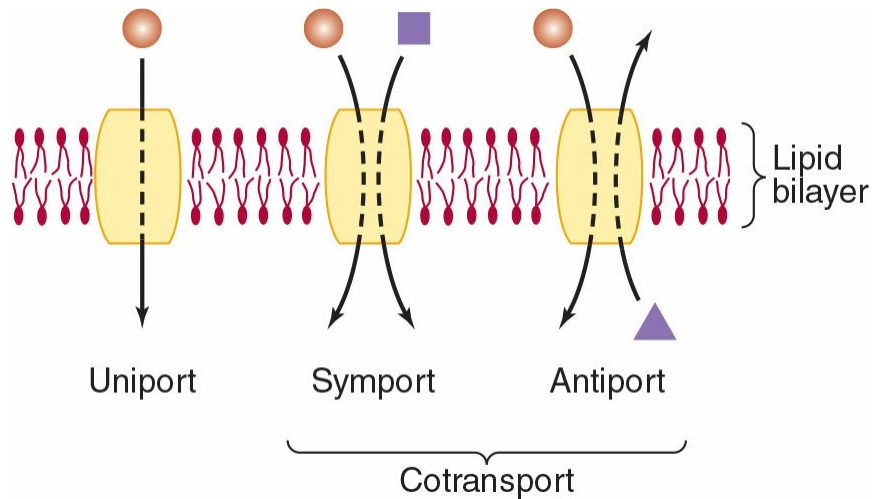

FIGURE 40–12 Schematic representation of types of transport systems. Transporters can be classified with regard to the direction of movement and whether one or more unique molecules are moved. A uniport can also allow movement in the opposite direction, depending on the concentrations inside and outside a cell of the molecule transported. (Redrawn and reproduced, with permission, from Alberts B, et al: *Molecular Biology of the Cell*. Garland, 1983.)

Hydrophilic molecules that cannot pass freely through the lipid bilayer membrane do so passively by **facilitated diffusion** or by **active transport**. Passive transport is driven by the transmembrane gradient of substrate. Active transport always occurs against an electrical or chemical gradient, and so it requires energy, usually in the form of ATP. Both types of transport involve **specific carrier proteins** (transporters) and both show **specificity** for ions, sugars, and amino acids. Passive and active transports resemble a substrate-enzyme interaction. Points of resemblance of both to enzyme action are as follows: (1) There is a specific binding site for the solute. (2) The carrier is saturable, so it has a maximum rate of transport (V_{\max} ; **Figure 40–13**). (3) There is a binding constant (K_m) for the solute, and so the whole system has a K_m (**Figure 40–13**). (4) Structurally similar competitive inhibitors block transport. Transporters are thus like enzymes, but generally do not modify their substrates.

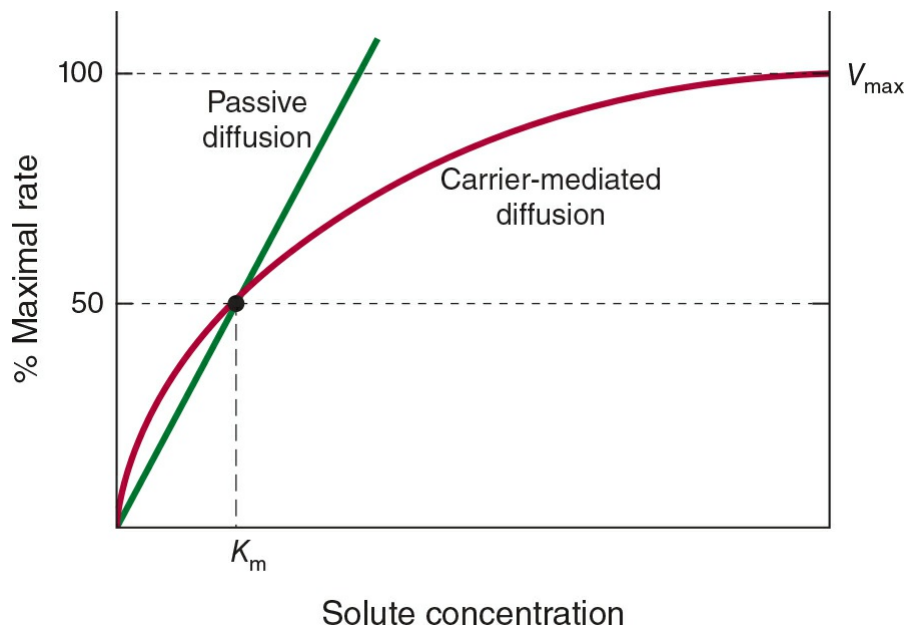

FIGURE 40–13 A comparison of the kinetics of carrier-mediated (facilitated) diffusion with passive diffusion. The rate of movement in the latter is directly proportionate to solute concentration, whereas the process is saturable when carriers are involved. The concentration at half-maximal velocity is equal to the binding constant (K_m) of the carrier for the solute. (V_{max} , maximal rate.)

Cotransporters use the gradient of one substrate created by active transport to drive the movement of the other substrate. The Na^+ gradient produced by the Na^+ - K^+ -ATPase is used to drive the transport of a number of important metabolites. The ATPase is a very important example of **primary transport**, while the Na^+ -dependent systems are examples of **secondary transport** that rely on the gradient produced by another system. Thus, inhibition of the Na^+ - K^+ -ATPase in cells also blocks the Na^+ -dependent uptake of substances like glucose.

Facilitated Diffusion Is Mediated by a Variety of Specific Transporters

Some specific solutes diffuse down electrochemical gradients across membranes more rapidly than might be expected from their size, charge, or partition coefficient. This is because specific transporters are involved. This **facilitated diffusion** exhibits properties distinct from those of simple diffusion. The rate of facilitated diffusion, a uniport system, can be saturated; that is, the number of sites involved in diffusion of the specific

solutes appears finite. Many facilitated diffusion systems are stereospecific but, like simple diffusion, are driven by the transmembrane electrochemical gradient.

A “**ping-pong**” mechanism (Figure 40–14) helps explain facilitated diffusion. In this model, the carrier protein exists in two principal conformations. In the “**ping**” state, it is exposed to high concentrations of solute, and molecules of the solute bind to specific sites on the carrier protein. Binding induces a conformational change that exposes the carrier to a lower concentration of solute (“**pong**” state). This process is completely reversible, and net flux across the membrane depends on the concentration gradient. The rate at which solutes enter a cell by facilitated diffusion is determined by (1) the concentration gradient across the membrane; (2) the amount of carrier available (this is a key control step); (3) the affinity of the solute-carrier interaction; (4) the rapidity of the conformational change for both the loaded and the unloaded carrier.

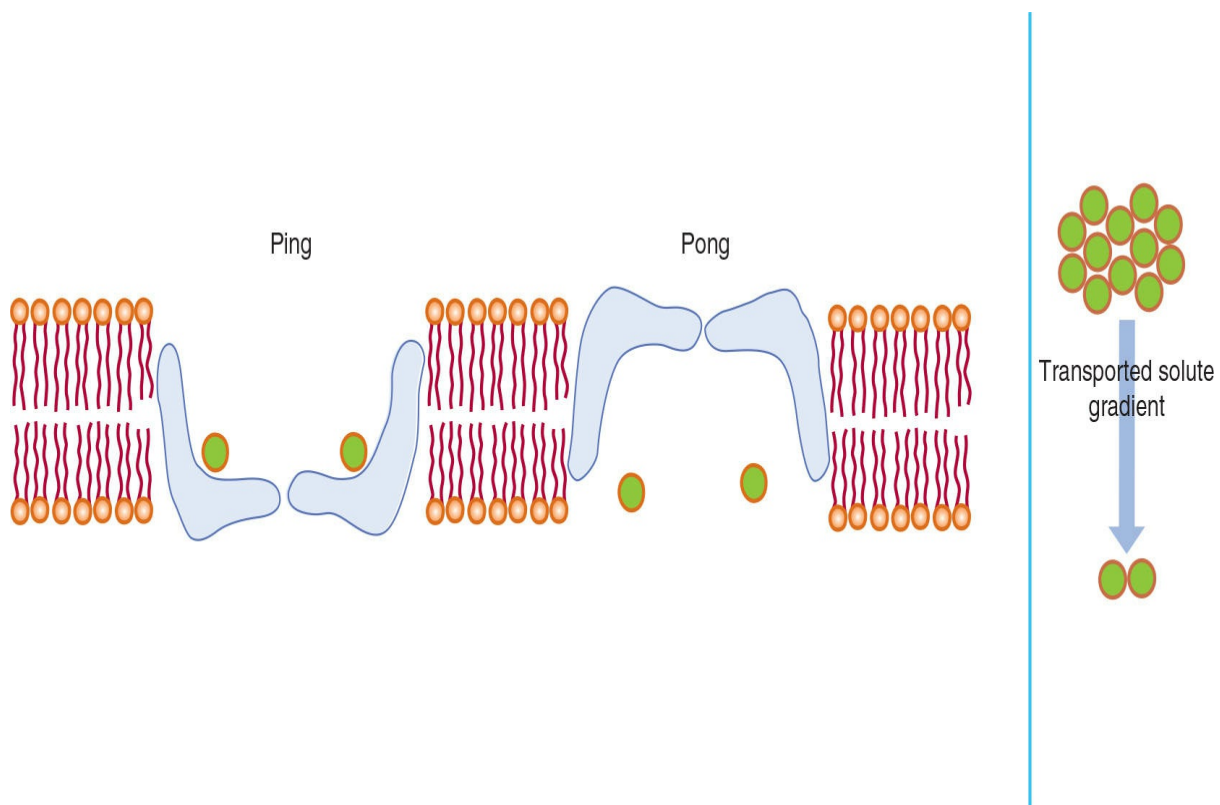

FIGURE 40–14 The “**ping-pong**” model of facilitated diffusion. A protein carrier (blue structure) in the lipid bilayer associates with a solute in high concentration on one side of the membrane. A conformational change ensues (“ping” to “pong”), and the solute is discharged on the side favoring the new equilibrium (solute concentration gradient shown schematically, right). The empty carrier then reverts to the original

conformation (“pong” to “ping”) to complete the cycle.

Hormones can regulate facilitated diffusion by changing the number of transporters available. Insulin via a complex signaling pathway increases glucose transport in fat and muscle by recruiting **glucose transporters (GLUT)** from an intracellular reservoir. Insulin also enhances amino acid transport in liver and other tissues. One of the coordinated actions of glucocorticoid hormones is to enhance transport of amino acids into liver, where the amino acids then serve as a substrate for gluconeogenesis. Growth hormone increases amino acid transport in all cells, and estrogens do this in the uterus. There are at least five different carrier systems for amino acids in animal cells. Each is specific for a group of closely related amino acids, and most operate as Na^+ -symport systems (Figure 40–12).

Ion Channels Are Transmembrane Proteins That Allow the Selective Entry of Various Ions

Natural membranes contain transmembrane channels, pore-like structures composed of proteins that constitute selective **ion channels**. Cation-conductive channels have an average diameter of about 5 to 8 nm. The **permeability** of a channel depends on the size, the extent of hydration, and the extent of charge density on the ion. Specific channels for Na^+ , K^+ , Ca^{2+} , and Cl^- have been identified. The functional α subunit of a Na^+ channel is schematically illustrated in Figure 40–15. The α subunit is composed of four domains (I-IV) each of which is formed by six contiguous transmembrane α -helices; each of these domains is connected by variable-length intra- and extracellular loops. The amino- and carboxy termini of the α subunit are located in the cytoplasm. The actual pore in the channel through which Na^+ ions pass is formed by interactions between the four domains, generating a tertiary structure by interactions between the four sets of 5,6 α -helices of domains I to IV. Na^+ channels are often **voltage sensitive** or **gated**; the voltage sensor of the channel is formed through the interaction domain I to IV the four α -helices-4 formed when domains I to IV interact. This ~5 to 8 nm pore constitutes the center of the tertiary channel structure.

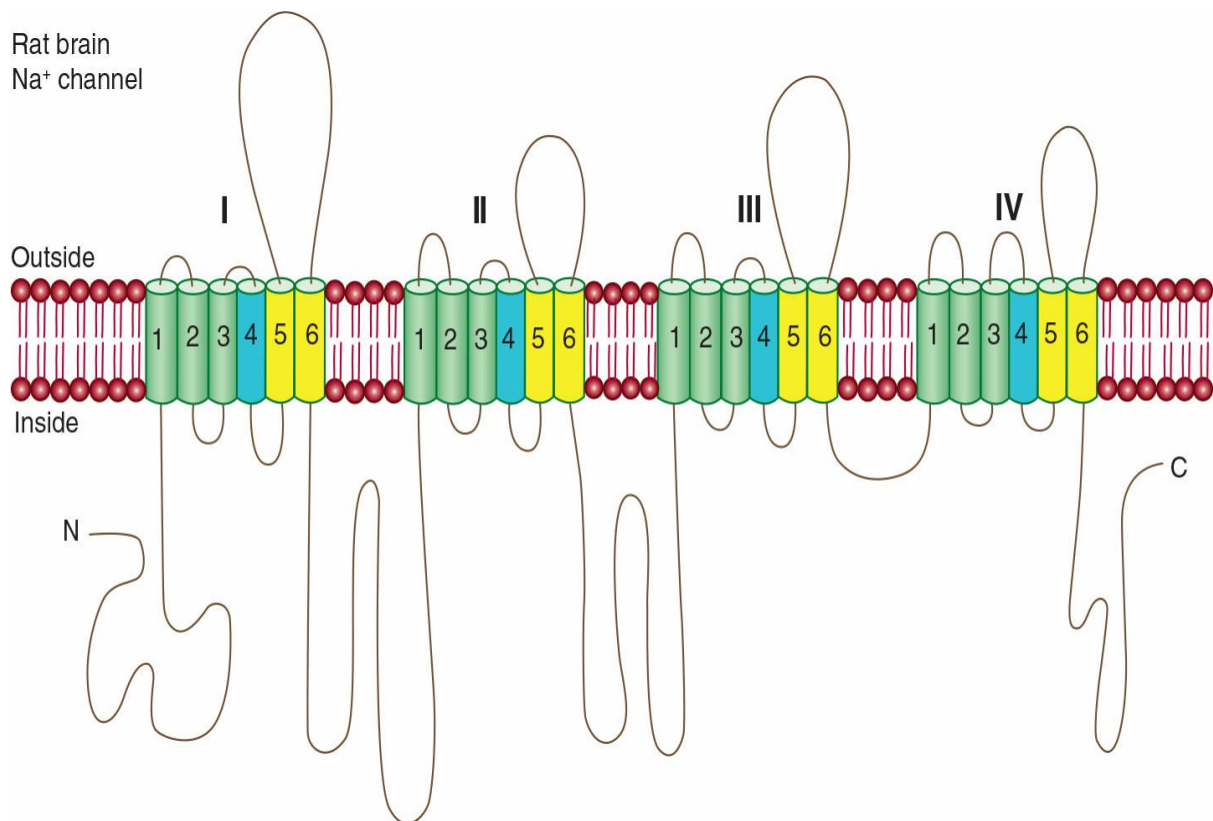

FIGURE 40–15 Diagrammatic representation of the structures of an ion channel (a Na^+ channel of rat brain). The Roman numerals indicate the four domains (I-IV) of the Na^+ channel α subunit. The α -helical transmembrane domains of each domain are numbered 1 to 6. The four blue-shaded subunits in the different domains represent the voltage-sensing portion of the α subunit. The actual pore through which the ions (Na^+) pass is not shown, but is formed by apposition of the 5 and 6 transmembrane α -helices of domains I to IV (colored yellow). The specific areas of the subunits involved in the opening and closing of the channel are also not indicated. (After WK Catterall. Modified and reproduced, with permission, from Hall ZW: *An Introduction to Molecular Neurobiology*. Sinauer, 1992.)

Ion channels are very **selective**, in most cases permitting the passage of only one type of ion (Na^+ , Ca^{2+} , etc). The **selectivity filter** of K^+ channels is made up of a ring of carbonyl groups donated by the subunits. The carbonyls displace bound water from the ion, and thus restrict its size to appropriate precise dimensions for passage through the channel. Many variations on the structural theme described above for the Na^+ channel have been described. However, all ion channels are basically made up of transmembrane subunits that come together to form a central pore through

which ions pass selectively.

The membranes of nerve cells contain well-studied ion channels that are responsible for the generation of action potentials. The activity of some of these channels is controlled by neurotransmitters; hence, channel activity can be regulated.

Ion channels are open transiently and thus are “gated.” Gates can be controlled by opening or closing. In **ligand-gated channels**, a specific molecule binds to a receptor and opens the channel. **Voltage-gated channels** open (or close) in response to changes in membrane potential. **Mechanically gated** channels respond to mechanical stimuli (pressure and touch). Some properties of ion channels are listed in **Tables 40–4** and **40–5**.

TABLE 40–5 Some Properties of Ion Channels

- They are composed of transmembrane protein subunits.
- Most are highly selective for one ion; a few are nonselective.
- They allow impermeable ions to cross membranes at rates approaching diffusion limits.
- They can permit ion fluxes of 10^6 - 10^7 /s.
- Their activities are regulated.
- The main types are voltage-gated, ligand-gated, and mechanically gated.
- They are usually highly conserved across species.
- Most cells have a variety of Na^+ , K^+ , Ca^{2+} , and Cl^- channels.
- Mutations in genes encoding them can cause specific diseases.^a
- Their activities are affected by certain drugs.

^aSome diseases caused by mutations of ion channels are briefly discussed in Chapter 49.

Detailed Studies of a K^+ Channel & of a Voltage-Gated Channel Have Yielded Major Insights Into Their Actions

There are at least four features of ion channels that must be elucidated: (1) their overall structures; (2) how they conduct ions so rapidly; (3) their selectivity; and (4) their gating properties. As described below, considerable progress in tackling these difficult problems has been made.

The K^+ channel (KvAP) is an integral membrane protein composed of four identical subunits, each with two transmembrane segments, creating an inverted “V”-like structure (Figure 40–16). The part of the channels that confers ion selectivity (the **selectivity filter**) measures 12-Å long (a relatively short length of the membrane, so K^+ does not have far to travel in the membrane) and is situated at the wide end of the inverted “V.” The large, water-filled cavity and helical dipoles shown in Figure 40–16 help overcome the relatively large electrostatic energy barrier for a cation to cross the membrane. The selectivity filter is lined with carbonyl oxygen atoms (contributed by a TVGYG sequence), providing a number of sites with which K^+ can interact. K^+ ions, which dehydrate as they enter the narrow selectivity filter, fit with proper coordination into the filter, but Na^+ is too small to interact with the carbonyl oxygen atoms in correct alignment and is rejected. Two K^+ ions, when close to each other in the filter, repel one another. This repulsion overcomes interactions between K^+ and the surrounding protein molecule and allows very rapid conduction of K^+ with high selectivity.

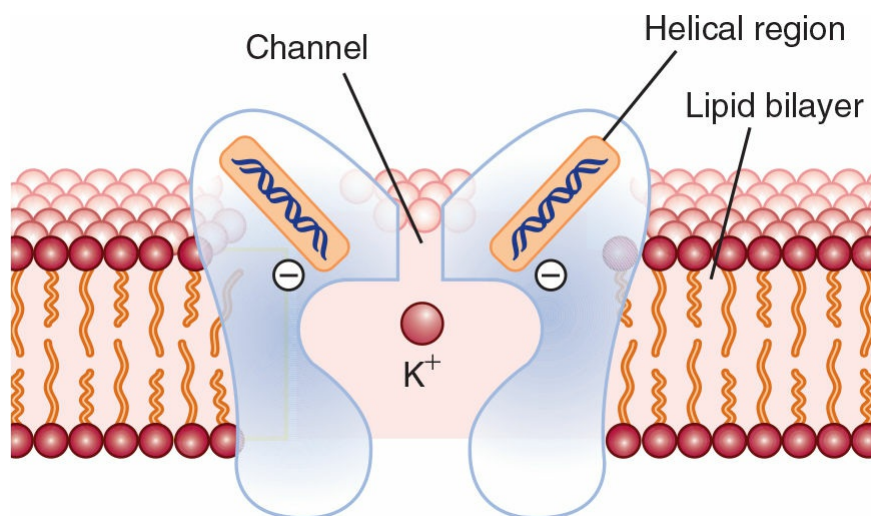

FIGURE 40–16 Schematic diagram of the structure of a K^+ channel (KvAP) from *Streptomyces lividans*. A single K^+ is shown in a large aqueous cavity inside the membrane interior. Two helical regions of the channel protein are oriented with their carboxylate ends pointing to where the K^+ is located. The channel is lined by carboxyl oxygen. (Modified, with permission, from Doyle DA, et al: The structure of the potassium channel: molecular basis of K^+ conduction and selectivity. *Science* 1998;280:69. Reprinted with permission from AAAS.)

Other studies on a voltage-gated ion channel (HvAP) in *Aeropyrum pernix* have revealed many features of its voltage-sensing and voltage-gating mechanisms. This channel is made up of four subunits, each with six transmembrane segments. One of the six segments (S4 and part of S3) is the voltage sensor. It behaves like a **charged paddle** (Figure 40–17), in that it can move through the interior of the membrane transferring four positive charges (due to four Arg residues in each subunit) from one membrane surface to the other in response to changes in voltage. There are four voltage sensors in each channel, linked to the gate. The gate part of the channel is constructed from S6 helices (one from each of the subunits). Movements of this part of the channel in response to changing voltage effectively close the channel or reopen it, in the latter case allowing a current of ions to cross the membrane.

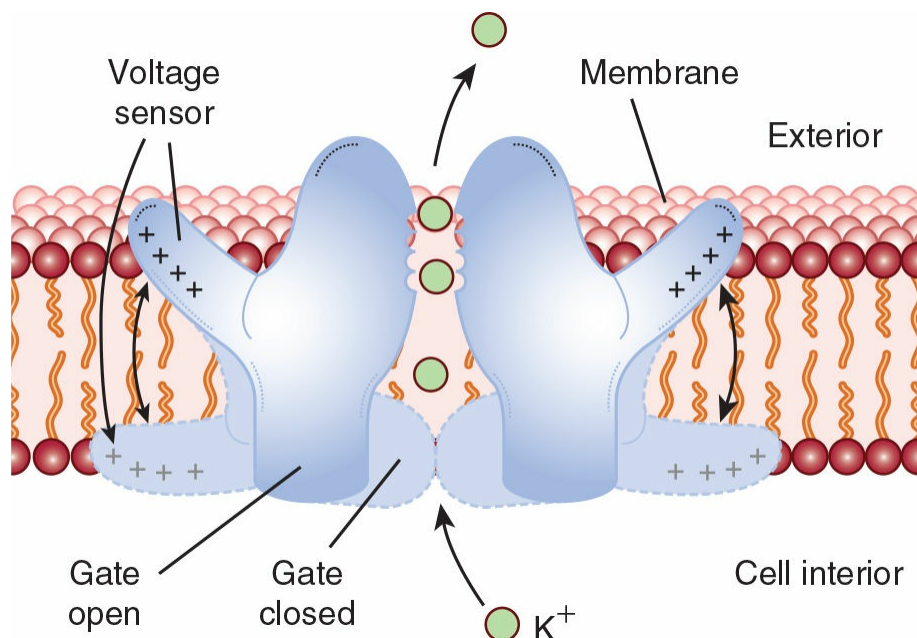

FIGURE 40–17 Schematic diagram of the voltage-gated K^+ channel of *Aeropyrum pernix*. The voltage sensors behave like charged paddles that move through the interior of the membrane. Four voltage sensors (only two are shown here) are linked mechanically to the gate of the channel. Each sensor has four positive charges contributed by arginine residues. (Modified, with permission, from Sigworth FJ: *Nature* 2003;423:21. Copyright © 2003. Macmillan Publishers Ltd.)

Ionophores Are Molecules That Act as Membrane Shuttles for Various Ions

Certain microbes synthesize small cyclic organic molecules, **ionophores**, such as **valinomycin** that function as shuttles for the movement of ions (K^+ in the case of valinomycin) across membranes. Ionophores contain hydrophilic centers that are surrounded by peripheral hydrophobic regions. Specific ions bind within the hydrophilic center of the molecule, which then diffuses through the membrane efficiently delivering the ion in question to the cytosol. Other ionophores (the polypeptide antibiotic **gramicidin**) fold up to form hollow channels through which ions can traverse the membrane.

Microbial toxins such as **diphtheria toxin** and activated **serum complement components** can produce large pores in cellular membranes and thereby provide macromolecules with direct access to the internal milieu. The toxin α -**hemolysin** (produced by certain species of *Streptococcus*) consists of seven subunits that come together to form a β -barrel that allows metabolites like ATP to leak out of cells, resulting in cell lysis.

Aquaporins Are Proteins That Form Water Channels in Certain Membranes

In certain cells (eg, red cells and cells of the collecting ductules of the kidney), the movement of water by simple diffusion is augmented by movement through **water channels**. These channels are composed of tetrameric transmembrane proteins named **aquaporins**. At least 10 distinct aquaporins (AP-1 to AP-10) have been identified. Crystallographic and other studies have revealed how these channels permit passage of water but exclude passage of ions and protons. In essence, the pores are too narrow to permit passage of ions. Protons are excluded by the fact that the oxygen atom of water binds to two asparagine residues lining the channel, making the water unavailable to participate in an H^+ relay, and thus preventing entry of protons. Mutations in the gene encoding AP-2 have been shown to be the cause of one type of **nephrogenic diabetes insipidus**, a condition in which there is an inability to concentrate urine.

ACTIVE TRANSPORT SYSTEMS REQUIRE A SOURCE OF ENERGY

The process of active transport differs from diffusion in that molecules are transported against concentration gradients; hence, energy is required. This

energy can come from the hydrolysis of ATP, from electron movement, or from light. The **maintenance of electrochemical gradients** in biologic systems is so important that it consumes approximately **30% of the total energy expenditure** in a cell.

As shown in **Table 40–6**, **four major classes of ATP-driven active transporters (P, F, V, and ABC transporters)** have been recognized. The nomenclature is explained in the legend to the table. The first example of the P class, the $\text{Na}^+ \text{-K}^+ \text{-ATPase}$, is discussed below. The Ca^{2+} ATPase of muscle is discussed in **Chapter 51**. The second class is referred to as F-type. The most important example of this class is the mt ATP synthase, described in **Chapter 13**. V-type active transporters pump protons into lysosomes and other structures. ABC transporters include the **CFTR** protein, a chloride channel involved in the causation of cystic fibrosis (described later in this chapter and in **Chapter 58**). Another important member of this class is the multidrug-resistance-1 protein (**MDR-1** protein). This transporter will pump a variety of drugs, including many anticancer agents, out of cells. It is a very important cause of cancer cells exhibiting resistance to chemotherapy, although many other mechanisms are also implicated (see **Chapter 56**).

TABLE 40–6 Major Types of ATP-Driven Active Transporters

Type	Example With Subcellular Location
P-type	Ca^{2+} ATPase (SR); $\text{Na}^+ \text{-K}^+ \text{-ATPase}$ (PM)
F-type	mt ATP synthase of oxidative phosphorylation
V-type	The ATPase that pumps protons into lysosomes and synaptic vesicles
ABC transporter	CFTR protein (PM); MDR-1 protein (PM)

Abbreviations: CFTR, cystic fibrosis transmembrane regulator protein, a Cl^- transporter, and the protein implicated in the causation of cystic fibrosis (see later in this chapter and also Chapter 57); MDR-1 protein (multidrug-resistance-1 protein), a protein that pumps many chemotherapeutic agents out of cancer cells and is thus an important contributor to the resistance of certain cancer cells to treatment; mt, mitochondrial; PM, plasma membrane; SR, sarcoplasmic reticulum of muscle.

P (in P-type) signifies phosphorylation (these proteins autophosphorylate).

F (in F-type) signifies energy coupling factors.

V (in V-type) signifies vacuolar.

ABC signifies ATP-binding cassette transporter (all have two nucleotide-binding domains and two transmembrane segments).

The Na^+ - K^+ -ATPase of the Plasma Membrane Is a Key Enzyme in Regulating Intracellular Concentrations of Na^+ and K^+

As shown in [Table 40–1](#), cells maintain a low intracellular Na^+ concentration and a high intracellular K^+ concentration, along with a net negative electrical potential inside. The pump that maintains these ionic gradients is an ATPase that is activated by Na^+ and K^+ (**Na^+ - K^+ -ATPase**). The Na^+ - K^+ -ATPase pumps three Na^+ out and two K^+ into cells ([Figure 40–18](#)). This pump is an integral membrane protein that contains a transmembrane domain allowing the passage of ions, and cytosolic domains that couple ATP hydrolysis to transport. There are catalytic centers for both ATP and Na^+ on the cytoplasmic (inner) side of the plasma membrane (PM), while there are K^+ -binding sites located on the extracellular side of the membrane. Phosphorylation by ATP induces a conformational change in the protein leading to the transfer of three Na^+ ions from the inner to the outer side of the plasma membrane. Two molecules of K^+ bind to sites on the protein on the external surface of the cell membrane, resulting in dephosphorylation of the protein and transfer of the K^+ ions across the membrane to the interior. Thus, three Na^+ ions are transported out for every two K^+ ions entering. This differential ion transport creates a charge imbalance between the inside and the outside of the cell, making the cell interior more negative (an **electrogenic** effect). Two clinically important cardiac drugs **ouabain** and **digitalis**, inhibit the Na^+ - K^+ -ATPase by binding to the extracellular domain. This enzyme can consume significant amounts of cellular ATP energy. The Na^+ - K^+ -ATPase can be coupled to various other transporters, such as those involved in transport of glucose (see below).

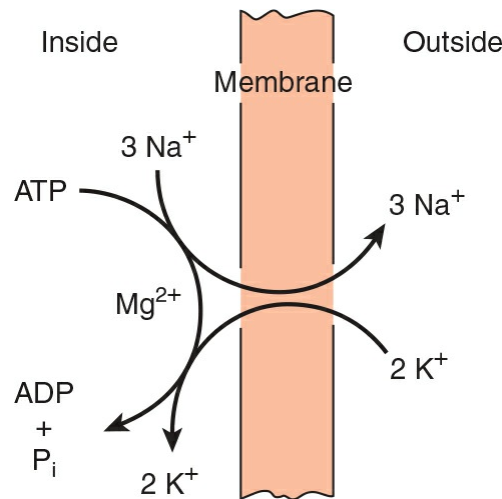

FIGURE 40–18 Stoichiometry of the Na⁺-K⁺-ATPase pump. This pump moves three Na⁺ ions from inside the cell to the outside and brings two K⁺ ions from the outside to the inside for every molecule of ATP hydrolyzed to ADP by the membrane-associated ATPase. Ouabain and other cardiac glycosides inhibit this pump by acting on the extracellular surface of the membrane. (Reprinted with permission from R Post.)

TRANSMISSION OF NERVE IMPULSES INVOLVES ION CHANNELS AND PUMPS

The membrane enclosing **neuronal cells** maintains an asymmetry of inside-outside voltage (electrical potential) and is also **electrically excitable** due to the presence of voltage-gated channels. When appropriately stimulated by a chemical signal mediated by a specific synaptic membrane receptor (see discussion of the transmission of biochemical signals, below), channels in the membrane are opened to allow the rapid influx of Na⁺ or Ca²⁺ (with or without the efflux of K⁺), so that the voltage difference rapidly collapses, and that segment of the membrane is **depolarized**. However, as a result of the action of the ion pumps in the membrane, the gradient is quickly restored.

When large areas of the membrane are **depolarized** in this manner, the electrochemical disturbance propagates in wave-like form down the membrane, generating a **nerve impulse**. **Myelin sheets**, formed by Schwann cells, wrap around nerve fibers and provide an **electrical insulator** that surrounds most of the nerve and greatly speeds up the propagation of the wave (signal) by allowing ions to flow in and out of the membrane only where the membrane is free of the insulation (at the **nodes of Ranvier**). The myelin membrane has a very high lipid content that

accounts for its excellent insulating property. Relatively few proteins are found in the myelin membrane; those present appear to hold together multiple membrane bilayers to form the hydrophobic insulating structure that is impermeable to ions and water. Certain diseases, for example, **multiple sclerosis** and the **Guillain-Barré syndrome**, are characterized by demyelination and impaired nerve conduction.

TRANSPORT OF GLUCOSE INVOLVES SEVERAL MECHANISMS

A discussion of the transport of glucose summarizes many of the points discussed above. Glucose must enter cells as the first step in energy utilization. A number of different glucose transporters (GLUTs) are involved, varying in different tissues (see [Table 19–2](#)). In adipocytes and skeletal muscle, glucose enters by a specific transport system (GLUT4) that is enhanced by insulin. Changes in transport are primarily due to alterations of V_{\max} (presumably from more or fewer transporters), but changes in K_m may also be involved.

Glucose transport in the small intestine involves some different aspects of the principles of transport discussed above. Glucose and Na^+ bind to different sites on a **Na^+ -glucose symporter** located at the **apical surface**. Na^+ moves into the cell down its electrochemical gradient and “drags” glucose with it ([Figure 40–19](#)). Therefore, the greater the Na^+ gradient, the more glucose enters; and if Na^+ in extracellular fluid is low, glucose transport stops. To maintain a steep Na^+ gradient, this Na^+ -glucose symporter is dependent on gradients generated by the Na^+ - K^+ -ATPase, which maintains a low intracellular Na^+ concentration. Similar mechanisms are used to transport other sugars as well as amino acids across the apical lumen in polarized cells such as are found in the intestine and kidney. The transcellular movement of glucose in this case involves one additional component, a uniport ([Figure 40–19](#)) that allows the glucose accumulated within the cell to move across the **basolateral membrane** and involves a **glucose uniporter** (GLUT2).

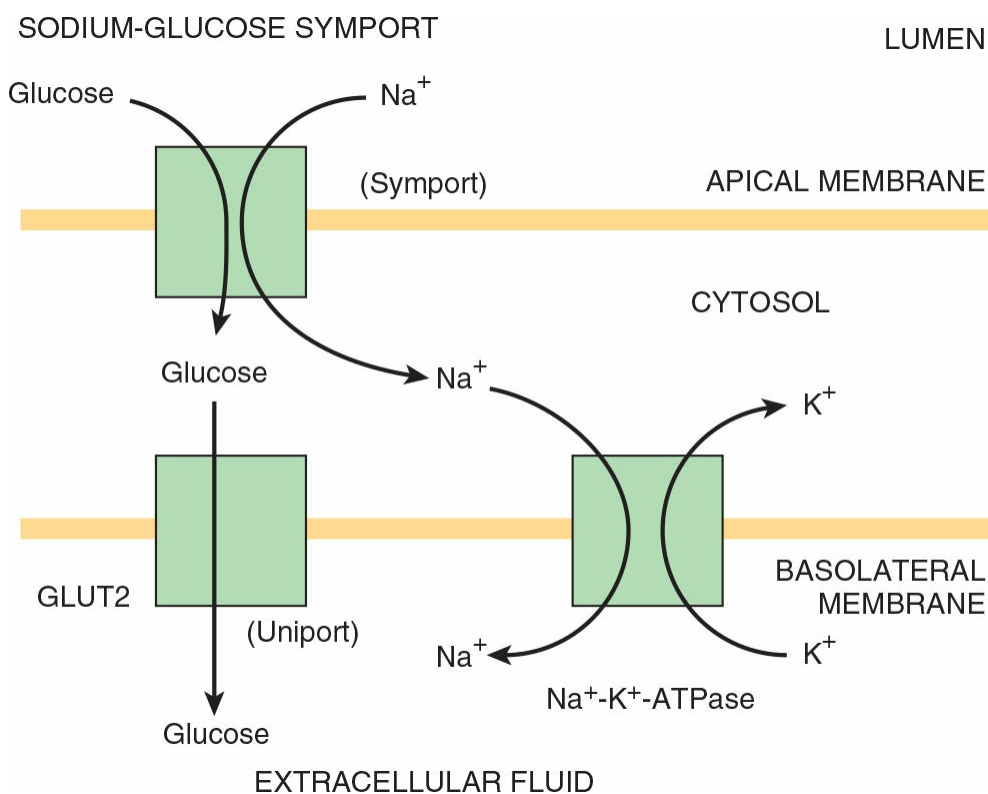

FIGURE 40–19 The transcellular movement of glucose in an intestinal cell. Glucose follows Na^+ across the luminal epithelial membrane. The Na^+ gradient that drives this symport is established by Na^+ - K^+ exchange, which occurs at the basolateral membrane facing the extracellular fluid compartment via the action of the Na^+ - K^+ -ATPase. Glucose at high concentration within the cell moves “downhill” into the extracellular fluid by facilitated diffusion (a uniport mechanism), via GLUT2 (a glucose transporter, see [Table 19–2](#)). The sodium-glucose symport actually carries 2 Na^+ for each glucose.

The treatment of severe cases of **diarrhea** (such as is found in cholera) makes use of the above information. In **cholera** (see [Chapter 57](#)), massive amounts of fluid can be passed as watery stools in a very short time, resulting in severe dehydration and possibly death. **Oral rehydration therapy**, consisting primarily of **NaCl and glucose**, has been developed by the World Health Organization (WHO). The transport of glucose and Na^+ across the intestinal epithelium forces (via osmosis) movement of water from the lumen of the gut into intestinal cells, resulting in rehydration. Glucose alone or NaCl alone would not be effective.

CELLS TRANSPORT CERTAIN

MACROMOLECULES ACROSS THE PLASMA MEMBRANE BY ENDOCYTOSIS AND EXOCYTOSIS

The process by which cells take up large molecules is called **endocytosis**. Some of these molecules, when hydrolyzed inside the cell, **yield nutrients** (eg, polysaccharides, proteins, and polynucleotides). Endocytosis also provides a mechanism for **regulating** the content of certain membrane components, hormone receptors being a case in point. Endocytosis can be used to learn more about how cells function. DNA from one cell type can be used to transfect a different cell and alter the latter's function or phenotype. A specific gene is often employed in these experiments, and this provides a unique way to study and analyze the regulation of that gene. **DNA transfection** depends on endocytosis, which is responsible for the entry of DNA into the cell. Such experiments commonly use calcium phosphate since Ca^{2+} stimulates endocytosis and precipitates DNA, which makes the DNA a better object for endocytosis (see [Chapter 39](#)). Cells also **release macromolecules** by **exocytosis**. Endocytosis and exocytosis both involve vesicle formation with or from the plasma membrane.

Endocytosis Involves Ingestion of Parts of the Plasma Membrane

Almost all eukaryotic cells are continuously recycling parts of their plasma membranes. Endocytotic vesicles are generated when segments of the plasma membrane invaginate, enclosing a small volume of extracellular fluid and its contents. The vesicle then pinches off as the fusion of plasma membranes seals the neck of the vesicle at the original site of invagination ([Figure 40–20](#)). The bilayer lipid membrane, or **vesicle** so generated, then fuses with other membrane structures and thus achieves the transport of its contents to other cellular compartments or even back to the cell exterior. Most endocytotic vesicles fuse with **primary lysosomes** to form **secondary lysosomes**, which contain hydrolytic enzymes and are therefore specialized organelles for intracellular disposal. The macromolecular contents are digested to yield amino acids, simple sugars, or nucleotides, which are transported out of the vesicles to be (re)used by the cell. Endocytosis requires (1) energy, usually from the hydrolysis of ATP; (2) Ca^{2+} ; and (3) contractile elements in the cell (likely the microfilament system) (see [Chapter 50](#)).

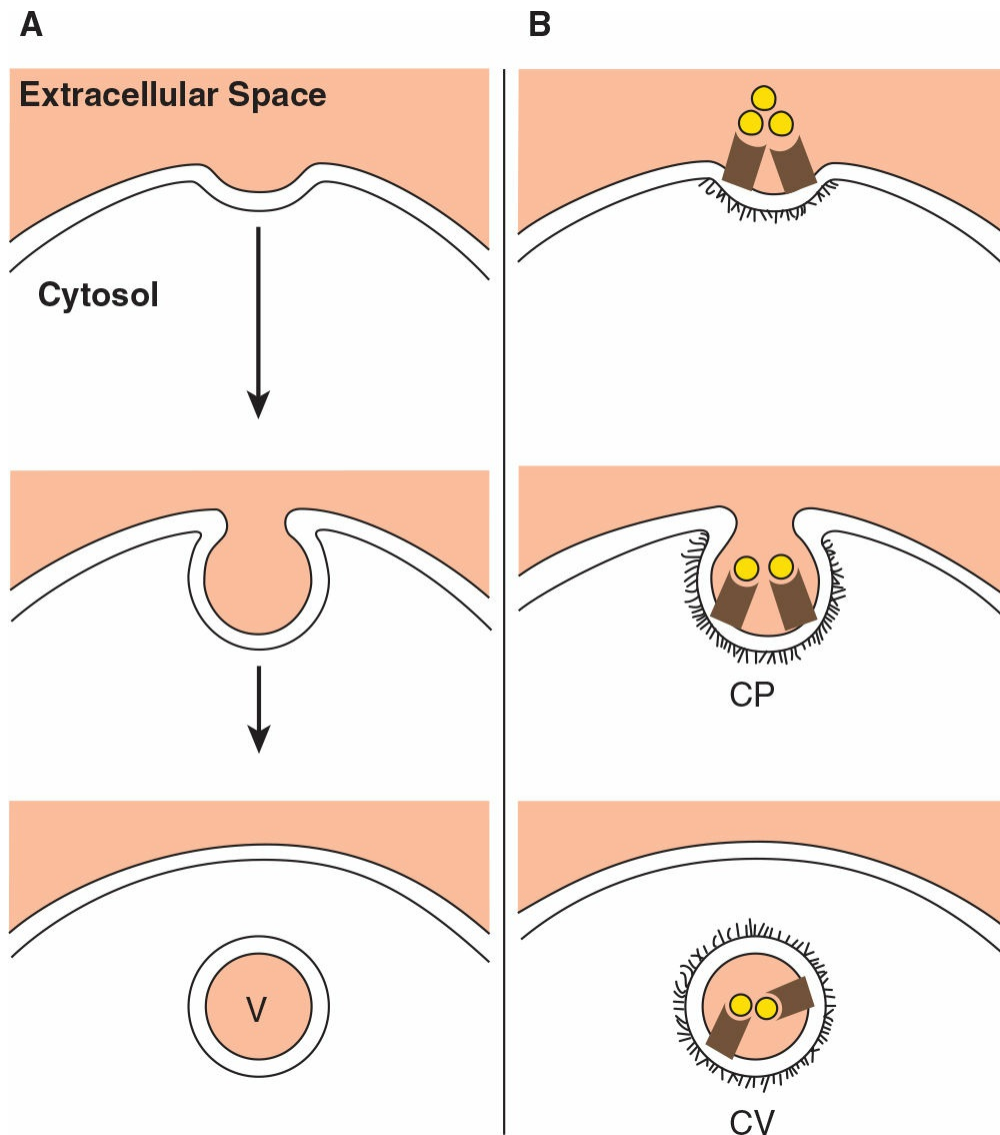

FIGURE 40–20 Two types of pinocytosis. An endocytotic vesicle (V) forms as a result of invagination of a portion of the plasma membrane. Fluid-phase pinocytosis (A) is random and nondirected. Absorptive (receptor-mediated endocytosis) (B) is selective and occurs in coated pits (CP) lined with the protein clathrin (the fuzzy material). Targeting is provided by receptors (brown symbols) specific for a variety of molecules. This results in the formation of an internalized clathrin-coated vesicle (CV).

There are two **general types of endocytosis**. **Phagocytosis** occurs only in specialized cells such as macrophages and granulocytes. Phagocytosis involves the ingestion of large particles such as viruses, bacteria, cells, or cellular debris. Macrophages are extremely active in this regard and may ingest 25% of their volume per hour. In so doing, a macrophage may internalize 3% of its plasma membrane each minute or the entire

membrane every 30 minutes.

Pinocytosis (“cell drinking”) is a property of all cells and leads to the cellular uptake of fluid and fluid contents. There are two types. **Fluid-phase pinocytosis** is a nonselective process in which the uptake of a solute by formation of small vesicles is simply proportionate to its concentration in the surrounding extracellular fluid. The formation of these vesicles is an extremely active process. Fibroblasts, for example, internalize their plasma membrane at about one-third the rate of macrophages. This process occurs more rapidly than membranes are made. The surface area and volume of a cell do not change much, so membranes must be replaced by exocytosis or by being recycled as fast as they are removed by endocytosis.

The other type of pinocytosis, **absorptive pinocytosis** or **receptor-mediated endocytosis**, is primarily responsible for the uptake of specific macromolecules for which there are binding sites on the plasma membrane. These high-affinity receptors permit the selective concentration of ligands from the medium, minimize the uptake of fluid or soluble unbound macromolecules, and markedly increase the rate at which specific molecules enter the cell. The vesicles formed during absorptive pinocytosis are derived from invaginations (pits) that are coated on the cytoplasmic side with a filamentous material and are appropriately named **coated pits**. In many systems, the protein **clathrin** is the filamentous material. It has a three-limbed structure (called a **triskelion**), with each limb being made up of one light and one heavy chain of clathrin. The polymerization of clathrin into a vesicle is directed by **assembly particles**, composed of four **adapter proteins**. These interact with certain amino acid sequences in the receptors that become cargo, ensuring selectivity of uptake. The lipid **phosphatidylinositol 4,5-bisphosphate (PIP₂)** (see [Chapter 21](#)) also plays an important role in vesicle assembly. In addition, the protein **dynamin**, which both binds and hydrolyzes GTP, is necessary for the pinching off of clathrin-coated vesicles from the cell surface. Coated pits may constitute as much as 2% of the surface of some cells. Other aspects of vesicles are discussed in [Chapter 49](#).

As an example, **the low-density lipoprotein (LDL)** molecule and its receptor (see [Chapter 25](#)) are internalized by means of coated pits containing the LDL receptor. Endocytotic vesicles containing the LDL-bound LDL receptor complex fuse to lysosomes in the cell. The receptor is released and recycled back to the cell surface membrane, but the apoprotein of LDL is degraded and the cholesteryl esters metabolized. Synthesis of the LDL receptor is regulated by secondary or tertiary consequences of pinocytosis, for example, by metabolic products—such as

cholesterol—released during the degradation of LDL. Disorders of the LDL receptor and its internalization are medically important and are discussed in [Chapters 25 and 26](#).

Absorptive pinocytosis of **extracellular glycoproteins** requires that the glycoproteins carry specific carbohydrate recognition signals. These recognition signals are bound by membrane receptor molecules that play a role analogous to that of the LDL receptor. A **galactosyl receptor** on the surface of hepatocytes is instrumental in the absorptive pinocytosis of **asialoglycoproteins** from the circulation (see [Chapter 46](#)). **Acid hydrolases** taken up by absorptive pinocytosis in fibroblasts are recognized by their **mannose 6-phosphate** moieties. Interestingly, the mannose 6-phosphate moiety also seems to play an important role in the intracellular targeting of the acid hydrolases to the lysosomes of the cells in which they are synthesized (see [Chapter 46](#)).

There is a problematic side to receptor-mediated endocytosis in that **viruses** which cause such diseases as hepatitis (affecting liver cells), poliomyelitis (affecting motor neurons), and AIDS (affecting T cells) initiate their infectious cycles by entering cells via this mechanism. **Iron toxicity** also begins with excessive uptake due to endocytosis.

Exocytosis Releases Certain Macromolecules From Cells

Most cells release macromolecules to the exterior by **exocytosis**. This process is also involved in membrane remodeling, when the components synthesized in the ER and Golgi are carried in vesicles that fuse with the plasma membrane. The signal for this “classical exocytosis” (see below) is often a hormone which, when it binds to a cell surface receptor, induces a local and transient change in Ca^{2+} concentration. Ca^{2+} triggers exocytosis. [Figure 40–21](#) provides a comparison of the mechanisms of exocytosis and endocytosis.

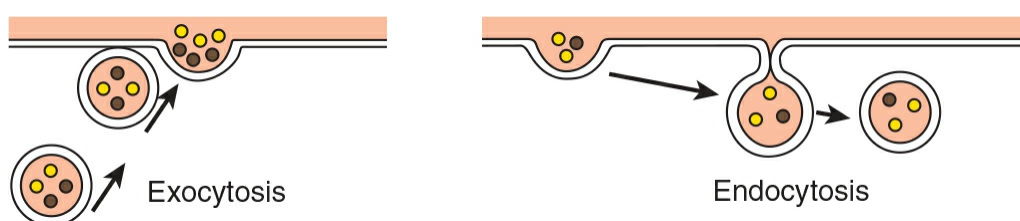

FIGURE 40–21 A comparison of the mechanisms of endocytosis and exocytosis. Exocytosis involves the contact of two inside-surface

(cytoplasmic side) monolayers, whereas endocytosis results from the contact of two outer-surface monolayers.

Molecules released by this mode of exocytosis have at least three fates: (1) they are membrane proteins and remain associated with the cell surface; (2) they can become part of the extracellular matrix, for example, collagen and glycosaminoglycans; (3) they can enter extracellular fluid and signal other cells. Insulin, parathyroid hormone, and the catecholamines are all packaged in granules and processed within cells, to be released on appropriate stimulation.

VARIOUS SIGNALS CAN BE TRANSMITTED ACROSS MEMBRANES

Specific biochemical signals such as neurotransmitters, hormones, and immunoglobulins bind to integral transmembrane receptor proteins via their exposed extracellular domains, thereby transmitting information through the membranes to the cytoplasm. This process, called **transmembrane signaling** or **signal transduction**, involves the generation of a number of second messenger signaling molecules, including cyclic nucleotides, calcium, phosphoinositides, and diacylglycerol (see [Chapter 42](#)). Many of the steps involve phosphorylation of receptors and downstream proteins.

GAP JUNCTIONS ALLOW DIRECT FLOW OF MOLECULES FROM ONE CELL TO ANOTHER

Gap junctions are structures that permit direct transfer of small molecules (up to ~1200 Da) from one cell to its neighbor. Gap junctions are composed of a family of proteins called **connexins** that form a bihexagonal structure consisting of 12 such proteins. Six connexins form a connexin hemichannel and join to a similar structure in a neighboring cell to make a complete, membrane-spanning **connexon channel** ([Figure 40–22](#)). One gap junction contains several connexons. Different connexins are found in different tissues. Mutations in genes encoding connexins have been found to be associated with a number of conditions, including cardiovascular abnormalities, one type of deafness, and the X-linked form of Charcot-Marie-Tooth disease (a demyelinating neurologic disorder).

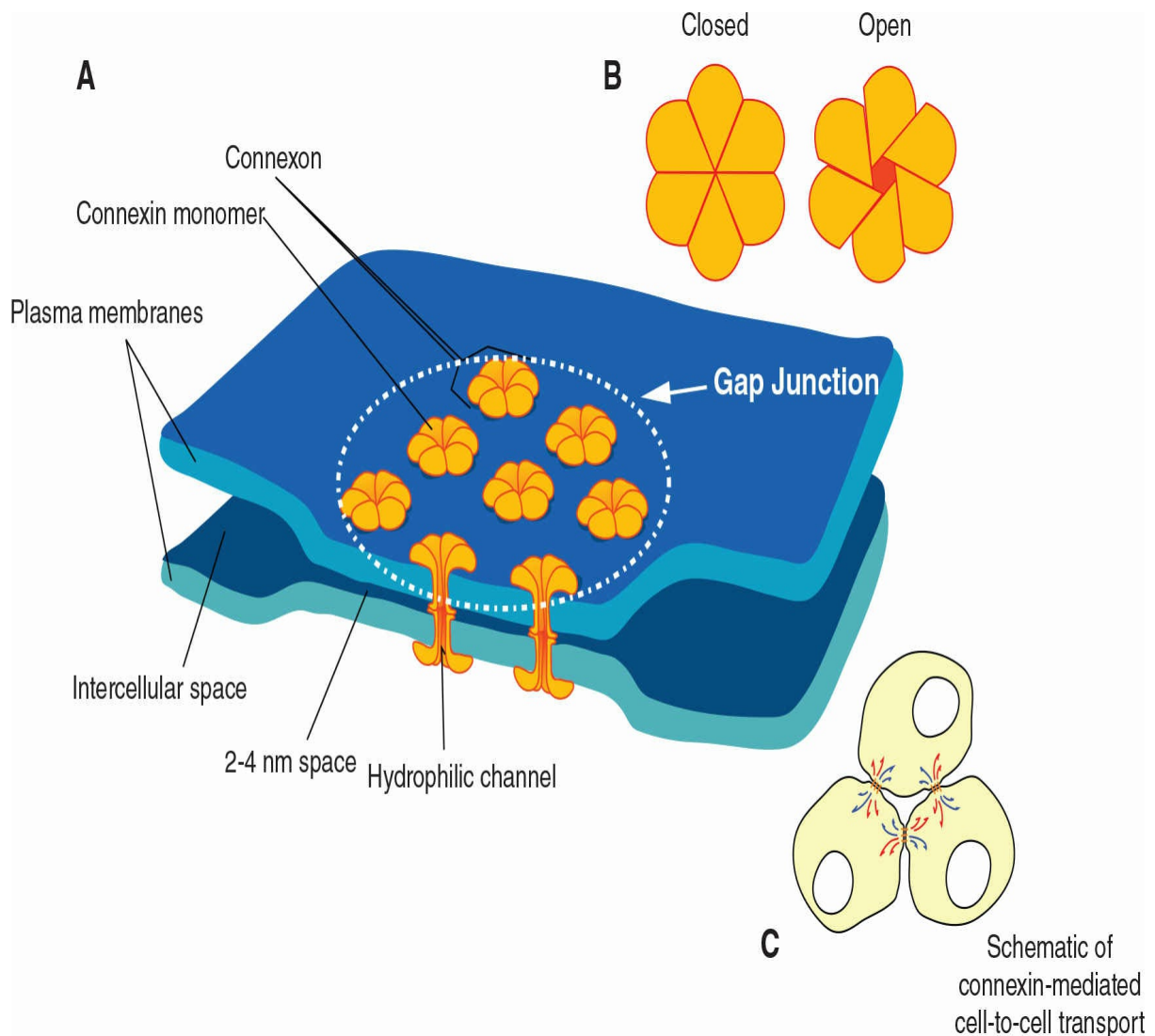

FIGURE 40–22 Schematic diagram of a gap junction. Shown schematically are (A) the relationships between cells containing connexin; (B) open and closed complete connexin channels; and (C) the flow of molecules (blue, red arrows) between a group of three cells. One connexon is made from two hemiconnexons. Each hemiconnexon is made from six connexin molecules. Small solutes are able to diffuse through the central channel when open, thereby providing a direct mechanism of cell–cell communication. Note that connexins connect cells that are within 2 to 4 nm of each other. Image source: http://upload.wikimedia.org/wikipedia/commons/b/b7/Gap_cell_junction-en.svg.

EXTRACELLULAR VESICLES (EXOSOMES) REPRESENT A NOVEL, AND PREVIOUSLY

UNDERAPPRECIATED MECHANISM OF CELL–CELL COMMUNICATION

In the last decade, a class of small, heterogeneous, secreted vesicles, broadly termed **extracellular vesicles**, have been identified and characterized. These extracellular vesicles have been implicated as a new and important mediator of cell–cell communication that likely contribute importantly to both normal and pathologic physiology. These vesicles, enclosed by a lipid bilayer, are somewhat heterogeneous in size (30–2000 nm diameter), and are generated by at least two distinct mechanisms (**Figure 40–23**): **microvesicles** are generated by budding from the plasma membrane of a **source cell**, while **exosomes** are generated from the multivesicular body (MVB), a component of the endocytic membrane trafficking system described above (ie, see **Figure 40–12**). Exosomes are secreted from the source cell upon fusion of the MVB with the plasma membrane. In both cases, the released extracellular vesicles (exosomes and microvesicles) ultimately fuse to their **target cell** to deliver a distinct “payload.” Unfortunately, given the recent discovery of extracellular vesicles, the exact names and terms used to describe these vesicles, their cargos, and relevant source and target cells vary in the biomedical literature. Moreover, the terms “microvesicle” and “exosome” are often lumped together as simply “exosomes.”

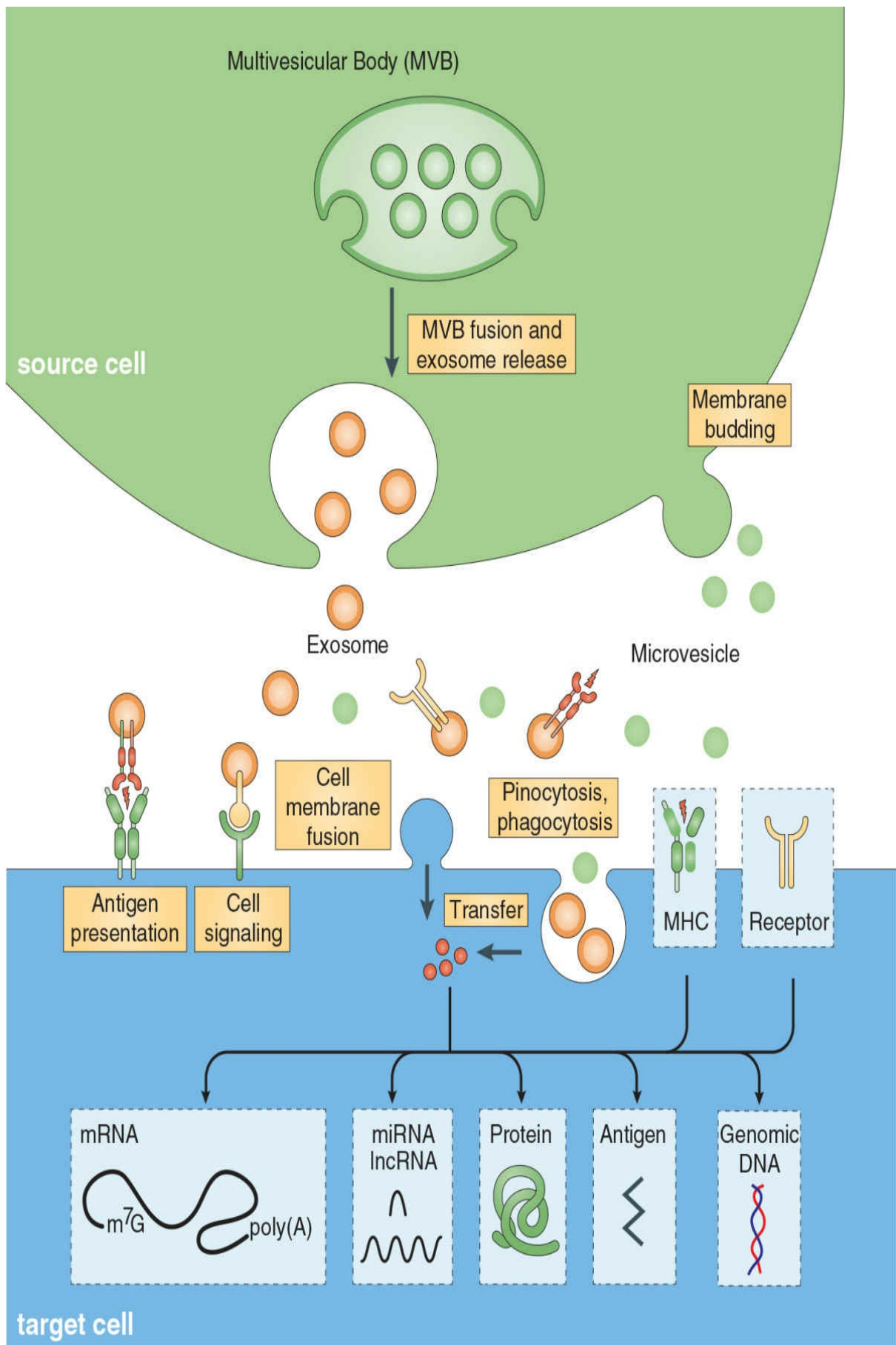

FIGURE 40–23 Cell–cell communication via extracellular vesicles.

Shown are the proposed mechanisms for the formation and production of exosomes and microvesicles via exocytosis (exosome) and membrane budding (microvesicle) from a **source** cell. Vesicles produced in the multivesicular body (MVB) can be exocytosed following fusion with the plasma membrane as shown, or budded into the extracellular space. All of these processes involve the collection of proteins, lipids, and signaling molecules previously implicated in exocytosis and budding (not shown). Once released from the source cell, the resulting exosomes and/or microvesicles locate their **target** cell, and following the types of vesicle–target cell interactions shown, release their contents (see black arrows within the target cell). Different vesicles have been shown to contain RNA (mRNA, miRNA, lncRNA; see [Chapter 36](#)) and DNA, specific bioactive proteins and lipids; antigens; and biologically active small molecules. Importantly, extracellular vesicles have been shown to have both positive and negative biologic effects on target cells in both normal and pathologic states.

Vesicle content varies from source cell to source cell and has even been reported to be different from the same source cell grown under different conditions. Vesicle payloads can include a variety of cytoplasmic and nuclear proteins, membrane-bound proteins ranging from channels to receptors, major histocompatibility complex (MHC) molecules, lipid raft-interacting proteins, DNA, mRNA, large and small ncRNAs, as well as small protein and bioactive small molecules ([Figure 40–23](#)). Given the rich and broad diversity of vesicle/exosome contents, it is not surprising that these structures have been implicated in a very broad range of biology and diseases. Moreover, given their membrane protein content and the fact that extracellular vesicles appear to target specific recipient cells, the potential value of exosomes as therapeutic delivery systems is receiving significant interest and attention in the pharmaceutical and biotechnology industries. Future work will determine whether this new and exciting area of biomedical research on extracellular vesicles lives up to this promise.

MUTATIONS AFFECTING MEMBRANE PROTEINS CAUSE DISEASES

In view of the fact that membranes are located in so many organelles and are involved in so many processes, it is not surprising that mutations affecting their protein constituents should result in many diseases or

disorders. While some mutations directly affect the function of membrane proteins, the majority cause protein misfolding that impair membrane trafficking at any of a number of steps from their site of synthesis in the ER to the plasma membrane or other intracellular sites/organelles (see [Chapter 49](#)). Examples of diseases or disorders due to abnormalities in membrane proteins are listed in [Table 40–7](#). These mainly reflect mutations in proteins of the plasma membrane, with one affecting lysosomal function (I-cell disease).

TABLE 40–7 Some Diseases or Pathologic States Resulting From or Attributed to Abnormalities of Membranes^a

Disease	Abnormality
Achondroplasia (OMIM 100800)	Mutations in the gene encoding the fibroblast growth factor receptor 3
Familial hypercholesterolemia (OMIM 143890)	Mutations in the gene encoding the LDL receptor
Cystic fibrosis (OMIM 219700)	Mutations in the gene encoding the CFTR protein, a Cl ⁻ transporter
Congenital long QT syndrome (OMIM 192500)	Mutations in genes encoding ion channels in the heart
Wilson disease (OMIM 277900)	Mutations in the gene encoding a copper-dependent ATPase
I-cell disease (OMIM 252500)	Mutations in the gene encoding GlcNAc phosphotransferase, resulting in absence of the Man 6-P signal for lysosomal localization of certain hydrolases
Hereditary spherocytosis (OMIM 182900)	Mutations in the genes encoding spectrin or other structural proteins in the red cell membrane
Metastasis of cancer cells	Abnormalities in the oligosaccharide chains of membrane glycoproteins and glycolipids are thought to be of importance
Paroxysmal nocturnal hemoglobinuria (OMIM 311770)	Mutation resulting in deficient attachment of the GPI anchor (see Chapter 46) to certain proteins of the red cell membrane

Abbreviations: CFTR, cystic fibrosis transmembrane regulator protein; GPI, glycosylphosphatidylinositol; LDL, low-density lipoprotein.

^aThe disorders listed are discussed further in other chapters. The table lists examples of mutations affecting two receptors, one transporter, several ion channels (ie, congenital long QT syndrome), two enzymes, and one structural protein. Examples of altered or defective glycosylation of glycoproteins are also presented. Most of the conditions listed involve the plasma membrane.

Proteins in plasma membranes can be classified as receptors, transporters, ion channels, enzymes, and structural components. Members of all of these classes are often glycosylated, so that mutations affecting

this process may alter their function (see [Chapter 46](#)). Mutations in receptors can cause defects in transmembrane signaling, a common occurrence in cancer (see [Chapter 56](#)). Many genetic diseases or disorders have been ascribed to mutations affecting various proteins involved in the transport of amino acids, sugars, lipids, urate, anions, cations, water, and vitamins across the plasma membrane.

Mutations in genes encoding proteins in other membrane-bound compartments can also have harmful consequences. For example, mutations in genes encoding mitochondrial membrane proteins involved in oxidative phosphorylation can cause neurologic and other problems (eg, **Leber hereditary optic neuropathy [LHON]**, a condition in which some success with gene therapy has been reported).

Membrane proteins can also be affected by conditions other than mutations. Formation of autoantibodies to the acetylcholine receptor in skeletal muscle causes myasthenia gravis. Ischemia can quickly affect the integrity of various ion channels in membranes. Overexpression of P-glycoprotein (MDR-1), a plasma membrane-localized drug pump, results in multidrug resistance (MDR) in cancer cells. Abnormalities of membrane constituents other than proteins can also be harmful. With regard to lipids, excess of cholesterol (eg, in familial hypercholesterolemia), of lysophospholipid (eg, after bites by certain snakes, whose venom contains phospholipases), or of glycosphingolipids (eg, in a sphingolipidosis), can all affect membrane structure and hence function.

Cystic Fibrosis Is due to Mutations in the Gene Encoding CFTR, a Chloride Transporter

Cystic fibrosis (CF) is a recessive genetic disorder prevalent among whites in North America and certain parts of northern Europe. CF is characterized by chronic bacterial infections of the airways and sinuses, fat maldigestion due to pancreatic exocrine insufficiency, infertility in males due to abnormal development of the vas deferens, and elevated levels of chloride in sweat (>60 mmol/L). It is now known that mutations in a gene encoding a protein named **cystic fibrosis transmembrane regulator protein (CFTR)** is responsible for CF. CFTR is a cyclic AMP-regulated Cl^- transporter. The major clinical features of CF and further information about the gene responsible for CF and about CFTR are presented in Case 5, [Chapter 57](#).

SUMMARY

- Membranes are complex dynamic structures composed of lipids, proteins, and carbohydrate-containing molecules.
- The basic structure of all membranes is the lipid bilayer. This bilayer is formed by two sheets of phospholipids in which the hydrophilic polar head groups are directed away from each other and are exposed to the aqueous environment on the outer and inner surfaces of the membrane. The hydrophobic nonpolar tails of these molecules are oriented toward each other, in the direction of the center of the membrane.
- Membranes are very dynamic structures. Lipids and certain proteins show rapid lateral diffusion. Flip-flop is very slow for lipids and almost nonexistent for proteins.
- The fluid mosaic model forms a useful basis for thinking about membrane structure and function.
- Membrane proteins are classified as integral if they are firmly embedded in the bilayer and as peripheral if they are attached to the outer or inner membrane surface.
- The 20 or so membranes in a mammalian cell have different compositions and functions and they define essential compartments, or specialized environments, within the cell that have specific functions.
- Certain hydrophobic molecules freely diffuse across membranes, but the movement of others is restricted because of their size and/or charge.
- Various passive and active (usually ATP-dependent) mechanisms are employed to maintain gradients of many different molecules across different membranes.
- Certain solutes, for example, glucose, enter cells by facilitated diffusion along a downhill gradient from high to low concentration using specific carrier proteins (transporters).
- The major ATP-driven pumps are classified as P (phosphorylated), F (energy factors), V (vacuolar), and ABC transporters.
- Ligand- or voltage-gated ion channels are often employed to move charged molecules (Na^+ , K^+ , Ca^{2+} , etc) across membranes down their electrochemical gradients.
- Large molecules can enter or leave cells through mechanisms such as endocytosis or exocytosis. These processes often require binding of

the molecule to a receptor, which affords specificity to the process.

- Extracellular vesicles, termed exosomes, also allow direct movement of macromolecules from cell to cell via small vesicles. Exosome payloads can include specific lipids, proteins (receptors, channels, signaling proteins), DNA, RNAs, and small bioactive molecules.
- Mutations that affect the structure of membrane proteins may cause diseases.

REFERENCES

- Boulanger CM, Loyer X, Rautou PE, Amabile N: Extracellular vesicles in coronary artery disease. *Nat Rev Cardiol* 2017;14(5):259-272.
- Doherty GJ, McMahon HT: Mechanisms of endocytosis. *Annu Rev Biochem* 2009;78:857-902.
- Fujimoto T, Parmryd I: Interleaflet coupling, pinning, and leaflet asymmetry-major players in plasma membrane nanodomain formation. *Front Cell Dev Biol* 2017;4:155.
- Longo N: Inherited defects of membrane transport. In *Harrison's Principles of Internal Medicine*, 17th ed. Fauci AS, et al (editors). McGraw-Hill, 2008.
- Mittelbrunn M, Sánchez-Madrid F: Intercellular communication: diverse structures for exchange of genetic information. *Nat Rev Mol Cell Biol* 2012;13:328-335.
- Nicolson GL: The Fluid-Mosaic Model of Membrane Structure: still relevant to understanding the structure, function and dynamics of biological membranes after more than 40 years. *Biochim Biophys Acta* 2014;1838:1451-1466.
- Raposo G, Stoorvogel W: Extracellular vesicles: exosomes, microvesicles, and friends. *J Cell Biol* 2013;200:373-383.
- Singer SJ: Some early history of membrane molecular biology. *Annu Rev Physiol* 2004;66:1-27.
- Spielberg DR, Clancy JP: Cystic fibrosis and its management through established and emerging therapies. *Annu Rev Genomics Hum Genet* 2016;17:155-175.
- Stone MB, Shelby SA, Veatch SL: Super-resolution microscopy: shedding light on the cellular plasma membrane. *Chem Rev* 2017;17(11):7457-7477.
- Vance DE, Vance J (editors): *Biochemistry of Lipids, Lipoproteins and Membranes*, 5th ed. Elsevier, 2008.

Voelker DR: Genetic and biochemical analysis of non-vesicular lipid traffic. *Annu Rev Biochem* 2009;78:827-856.

The Diversity of the Endocrine System

P. Anthony Weil, PhD

OBJECTIVES

After studying this chapter, you should be able to:

- Explain the basic principles of endocrine hormone action.
- Understand the broad diversity and mechanisms of action of endocrine hormones.
- Appreciate the complex steps involved in the production, transport, and storage of hormones.

ACTH	Adrenocorticotrophic hormone	IGF-I	Insulin-like growth factor I
ANF	Atrial natriuretic factor	LH	Luteotropic hormone
cAMP	Cyclic adenosine monophosphate	LPH	Lipotropin
CBG	Corticosteroid-binding globulin	MIT	Monoiodotyrosine
CG	Chorionic gonadotropin	MSH	Melanocyte-stimulating hormone
cGMP	Cyclic guanosine monophosphate	OHSD	Hydroxysteroid dehydrogenase
CLIP	Corticotropin-like intermediate lobe peptide	PNMT	Phenylethanolamine-N-methyltransferase
DBH	Dopamine β -hydroxylase	POMC	Pro-opiomelanocortin
DHEA	Dehydroepiandrosterone	PRL	Prolactin
DHT	Dihydrotestosterone	SHBG	Sex hormone-binding globulin
DIT	Diiodotyrosine	StAR	Steroidogenic acute regulatory (protein)
DOC	Deoxycorticosterone	TBG	Thyroxine-binding globulin
EGF	Epidermal growth factor	TEBG	Testosterone-estrogen-binding globulin
FSH	Follicle-stimulating hormone	TRH	Thyrotropin-releasing hormone
GH	Growth hormone	TSH	Thyrotropin-stimulating hormone

BIOMEDICAL IMPORTANCE

The survival of multicellular organisms depends on their ability to adapt to a constantly changing environment. Intercellular communication mechanisms are necessary requirements for this adaptation. The nervous system and the endocrine system provide this intercellular, organism-wide communication. The nervous system was originally viewed as providing a fixed communication system, whereas the endocrine system supplied hormones, which are mobile messages. In fact, there is a remarkable convergence of these regulatory systems. For example, neural regulation of the endocrine system is important in the production and secretion of some hormones; many neurotransmitters resemble hormones in their synthesis, transport, and mechanism of action; and many hormones are synthesized in the nervous system. The word “hormone” is derived from a Greek term that means to arouse to activity. As classically defined, a

hormone is a substance that is synthesized in one organ and transported by the circulatory system to act on another tissue. However, this original description is too restrictive because hormones can act on adjacent cells (paracrine action) and on the cell in which they were synthesized (autocrine action) without entering the systemic circulation. A diverse array of hormones—each with distinctive mechanisms of action and properties of biosynthesis, storage, secretion, transport, and metabolism—has evolved to provide homeostatic responses. This biochemical diversity is the topic of this chapter.

THE TARGET CELL CONCEPT

There are over 200 types of differentiated cells in humans. Only a few produce hormones, but virtually all of the 75 trillion cells in a human are targets of one or more of the 50⁺ known hormones. The concept of the target cell is a useful way of looking at hormone action. It was thought that hormones affected a single cell type—or only a few kinds of cells—and that a hormone elicited a unique biochemical or physiologic action. We now know that a given hormone can affect several different cell types; that more than one hormone can affect a given cell type; and that hormones can exert many different effects in one cell or in different cells. With the discovery of specific cell surface and intracellular hormone receptors, the definition of a target has been expanded to include any cell in which the hormone (ligand) binds to its receptor, whether or not a biochemical or physiologic response has yet been determined.

Several factors determine the response of a target cell to a hormone. These can be thought of in two general ways: (1) as factors that affect the concentration of the hormone at the target cell (**Table 41–1**) and (2) as factors that affect the actual response of the target cell to the hormone (**Table 41–2**).

TABLE 41–1 Determinants of the Concentration of a Hormone at the Target Cell

The rate of synthesis and secretion of the hormones.
The proximity of the target cell to the hormone source (dilution effect).
The affinity (dissociation constant; K_d) of the hormone with specific plasma transport proteins (if any).
The conversion of inactive or suboptimally active forms of the hormone into the fully active form.
The rate of clearance of hormone from plasma, by other tissues, or by degradation, metabolism, or excretion.

TABLE 41–2 Determinants of the Target Cell Response

The number, relative activity, and state of occupancy of the specific receptors on the plasma membrane or in the cytoplasm or nucleus.
The metabolism (activation or inactivation) of the hormone in the target cell.
The presence of other factors within the cell that are necessary for the hormone response.
Up- or downregulation of the receptor consequent to the interaction with its ligand.
Postreceptor desensitization of the cell, including downregulation of the receptor.

HORMONE RECEPTORS ARE OF CENTRAL IMPORTANCE

Receptors Discriminate Precisely

One of the major challenges faced in making the hormone-based communication system work is illustrated in **Figure 41–1**. Hormones are present at very low concentrations in the extracellular fluid, generally in the femto- to nanomolar range (10^{-15} - 10^{-9} mol/L). This concentration is much lower than that of the many structurally similar molecules (sterols, amino acids, peptides, and proteins) and other molecules that circulate at concentrations in the micro- to millimolar (10^{-6} - 10^{-3} mol/L) range. Target cells, therefore, must distinguish not only between different hormones present in small amounts but also between a given hormone and the 10^6 -

to 10^9 -fold excess of other similar molecules. This high degree of discrimination is provided by cell-associated recognition molecules called receptors. Hormones initiate their biologic effects by binding to hormone-specific receptors, and since any effective control system also must provide a means of stopping a response, hormone-induced actions generally, but not always, terminate when the effector dissociates from the receptor (see [Figure 38–1](#); type A response).

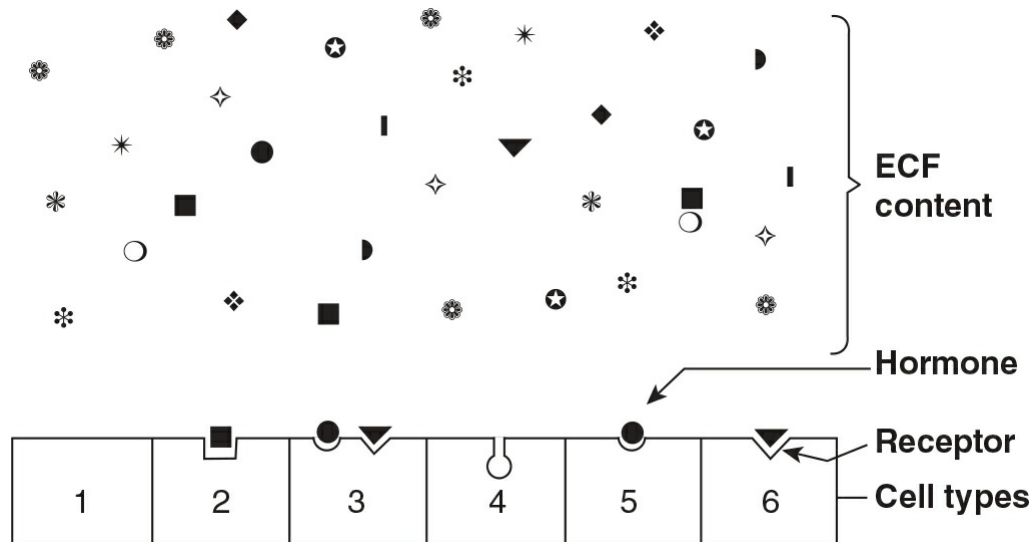

FIGURE 41–1 Specificity and selectivity of hormone receptors. Many different molecules circulate in the extracellular fluid (ECF), but only a few are recognized by hormone receptors. Receptors must select these molecules from among high concentrations of the other molecules. This simplified drawing shows that a cell may have no hormone receptors (Cell type 1), have one receptor (Cell types 2+5+6), have receptors for several hormones (Cell type 3), or have a receptor but no hormone in the vicinity (Cell type 4).

A target cell is defined by its ability to selectively bind a given hormone to its cognate receptor. Several biochemical features of this interaction are important in order for hormone-receptor interactions to be physiologically relevant: (1) binding should be specific, that is, displaceable by agonist or antagonist; (2) binding should be saturable; and (3) binding should occur within the concentration range of the expected biologic response.

Both Recognition & Coupling Domains Occur on Receptors

All receptors have at least two functional domains. A recognition domain binds the hormone ligand and a second region generates a signal that couples hormone recognition to some intracellular function. This coupling, or signal transduction, occurs in two general ways. Polypeptide and protein hormones and the catecholamines bind to receptors located in the plasma membrane and thereby generate a signal that regulates various intracellular functions, often by changing the activity of an enzyme. By contrast, the lipophilic steroid, retinoid, and thyroid hormones interact with intracellular receptors, and it is this ligand-receptor complex that directly provides the signal, generally to specific genes whose rate of transcription is thereby affected.

The domains responsible for hormone recognition and signal generation have been identified in the protein polypeptide and catecholamine hormone receptors. Like many other DNA-binding transcription factors, the steroid, thyroid, and retinoid hormone receptors have several functional domains: one site binds the hormone; another binds to specific DNA regions; a third is involved in the interaction with various coregulator proteins that result in the activation (or repression) of gene transcription; and a fourth region may specify binding to one or more other proteins that influence the intracellular trafficking of the receptor (see [Figure 38–19](#)).

The dual functions of binding and coupling ultimately define a receptor, and it is the coupling of hormone binding to signal transduction, the so-called **receptor-effector coupling**—that provides the first step in amplification of the hormonal response. This dual purpose also distinguishes the target cell receptor from the plasma carrier proteins that bind hormone but do not generate a signal (see [Table 41–6](#)).

Receptors Are Proteins

Several classes of peptide hormone receptors have been defined. For example, the insulin receptor is a heterotetramer composed of two copies of two different protein subunits ($\alpha_2\beta_2$) linked by multiple disulfide bonds in which the extracellular α subunit binds insulin and the membrane-spanning β subunit transduces the signal through the tyrosine protein kinase domain located in the cytoplasmic portion of this polypeptide. The receptors for **insulin-like growth factor I (IGF-I)** and **epidermal growth factor (EGF)** are generally similar in structure to the insulin receptor. The **growth hormone (GH)** and **prolactin (PRL)** receptors also span the plasma membrane of target cells but do not contain intrinsic protein kinase

activity. Ligand binding to these receptors, however, results in the association and activation of a completely different protein kinase signaling pathway, the Jak-Stat pathway. Polypeptide hormone and catecholamine receptors, which transduce signals by altering the rate of production of **cAMP** through **G-proteins**, which are guanosine nucleotide-binding proteins that are characterized by the presence of seven membrane-spanning domains. Protein kinase activation and the generation of cyclic AMP (cAMP, 3'5'-adenylic acid; see [Figure 18–5](#)) is a downstream action of this class of receptor (see [Chapter 42](#) for further details).

A comparison of several different steroid receptors with thyroid hormone receptors revealed a remarkable conservation of the amino acid sequence in certain regions, particularly in the DNA-binding domains. This observation led to the realization that receptors of the steroid and thyroid type are members of a large superfamily of nuclear receptors. Many related members of this family currently have no known ligand and thus are called orphan receptors. The nuclear receptor superfamily plays a critical role in the regulation of gene transcription by hormones, as described in [Chapter 42](#).

HORMONES CAN BE CLASSIFIED IN SEVERAL WAYS

Hormones can be classified according to chemical composition, solubility properties, location of receptors, and the nature of the signal used to mediate hormonal action within the cell. A classification based on the last two properties is illustrated in [Table 41–3](#), and general features of each group are illustrated in [Table 41–4](#).

TABLE 41–3 Classification of Hormones by Mechanism of Action

I. Hormones that bind to intracellular receptors

Androgens
Calcitriol (1,25[OH]₂-D₃)
Estrogens
Glucocorticoids
Mineralocorticoids
Progestins
Retinoic acid
Thyroid hormones (T₃ and T₄)

II. Hormones that bind to cell surface receptors

A. The second messenger is cAMP

α₂-Adrenergic catecholamines
β-Adrenergic catecholamines
Adrenocorticotrophic hormone (ACTH)
Antidiuretic hormone (vasopressin)
Calcitonin
Chorionic gonadotropin, human (CG)
Corticotropin-releasing hormone
Follicle-stimulating hormone (FSH)
Glucagon
Lipotropin (LPH)
Luteinizing hormone (LH)
Melanocyte-stimulating hormone (MSH)
Parathyroid hormone (PTH)
Somatostatin
Thyroid-stimulating hormone (TSH)

B. The second messenger is cGMP

Atrial natriuretic factor
Nitric oxide

C. The second messenger is calcium or phosphatidylinositols (or both)

Acetylcholine (muscarinic)
α₁-Adrenergic catecholamines
Angiotensin II
Antidiuretic hormone (vasopressin)
Cholecystokinin
Gastrin
Gonadotropin-releasing hormone
Oxytocin
Platelet-derived growth factor (PDGF)
Substance P
Thyrotropin-releasing hormone (TRH)

D. The second messenger is a kinase or phosphatase cascade

Adiponectin
Chorionic somatomammotropin
Epidermal growth factor (EGF)
Erythropoietin (EPO)
Fibroblast growth factor (FGF)
Growth hormone (GH)
Insulin
Insulin-like growth factors I and II
Leptin
Nerve growth factor (NGF)
Platelet-derived growth factor
Prolactin

TABLE 41–4 General Features of Hormone Classes

	Group I	Group II
Types	Steroids, iodothyronines, calcitriol, retinoids	Polypeptides, proteins, glycoproteins, catecholamines
Solubility	Lipophilic	Hydrophilic
Transport proteins	Yes	No
Plasma half-life	Long (hours to days)	Short (minutes)
Receptor	Intracellular	Plasma membrane
Mediator	Receptor-hormone complex	cAMP, cGMP, Ca ²⁺ , metabolites of complex phosphoinositols, kinase cascades

The hormones in group I are lipophilic. After secretion, these hormones associate with plasma transport or carrier proteins, a process that circumvents the problem of solubility while prolonging the plasma half-life of the hormone. The relative percentages of bound and free hormone are determined by the amount, binding affinity, and binding capacity of the transport protein. The free hormone, which is the biologically active form, readily traverses the lipophilic plasma membrane of all cells and encounters receptors in either the cytosol or nucleus of target cells. The ligand-receptor complex is the intracellular messenger in this group.

The second major group consists of water-soluble hormones that bind to specific receptors spanning the plasma membrane of the target cell. Hormones that bind to these surface receptors of cells communicate with intracellular metabolic processes through intermediary molecules called **second messengers** (the hormone itself is the first messenger), which are generated as a consequence of the ligand-receptor interaction. The second messenger concept arose from an observation that epinephrine binds to the plasma membrane of certain cells and increases intracellular cAMP. This was followed by a series of experiments in which cAMP was found to mediate the effects of many hormones. Hormones that employ this mechanism are shown in group II.A of [Table 41–3](#). Atrial natriuretic factor (ANF) uses cGMP as its second messenger (group II.B). Several

hormones, many of which were previously thought to affect cAMP, appear to use ionic calcium (Ca^{2+}) or metabolites of complex phosphoinositides (or both) as the intracellular second messenger signal. These are shown in group II.C of the table. The intracellular messenger for group II.D is a protein kinase–phosphatase cascade; several have been identified, and a given hormone may use more than one kinase cascade. A few hormones fit into more than one category, and assignments change as new information is discovered.

DIVERSITY OF THE ENDOCRINE SYSTEM

Hormones Are Synthesized in a Variety of Cellular Arrangements

Hormones are synthesized in discrete organs designed solely for this specific purpose, such as the thyroid (triiodothyronine), adrenal (glucocorticoids and mineralocorticoids), and the pituitary (TSH, FSH, LH, GH, PRL, ACTH). Some organs are designed to perform two distinct but closely related functions. For example, the ovaries produce mature oocytes and the reproductive hormones estradiol and progesterone. The testes produce mature spermatozoa and testosterone. Hormones are also produced in specialized cells within other organs such as the small intestine (glucagon-like peptide), thyroid (calcitonin), and kidney (angiotensin II). Finally, the synthesis of some hormones requires the parenchymal cells of more than one organ—for example, the skin, liver, and kidney are required for the production of $1,25(\text{OH})_2\text{-D}_3$ (calcitriol). Examples of this diversity in the approach to hormone synthesis, each of which has evolved to fulfill a specific purpose, are discussed below.

Hormones Are Chemically Diverse

Hormones are synthesized from a wide variety of chemical building blocks. A large series is derived from cholesterol. These include the glucocorticoids, mineralocorticoids, androgens, estrogens, progestins, and $1,25(\text{OH})_2\text{-D}_3$ (**Figure 41–2**). In some cases, a steroid hormone is the precursor molecule for another hormone. For example, progesterone is a hormone in its own right but is also a precursor in the formation of glucocorticoids, mineralocorticoids, testosterone, and estrogens. Testosterone is an obligatory intermediate in the biosynthesis of estradiol and in the formation of dihydrotestosterone (DHT). In these examples,

described in detail below, the final product is determined by the cell type and the associated set of enzymes in which the precursor exists.

A. Cholesterol derivatives

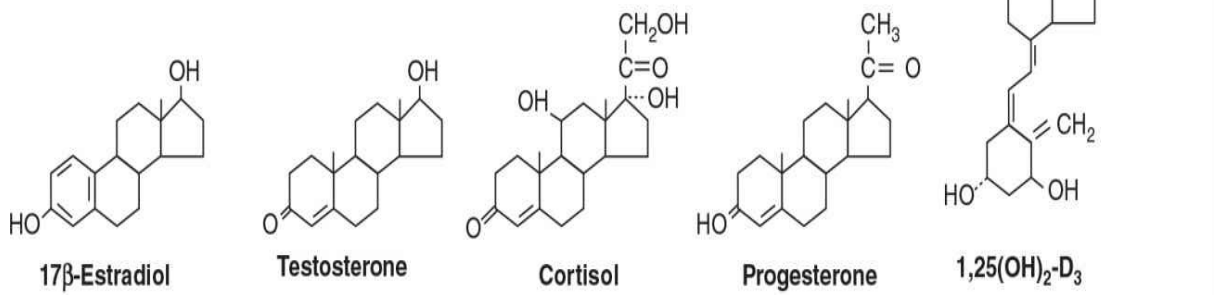

B. Tyrosine derivatives

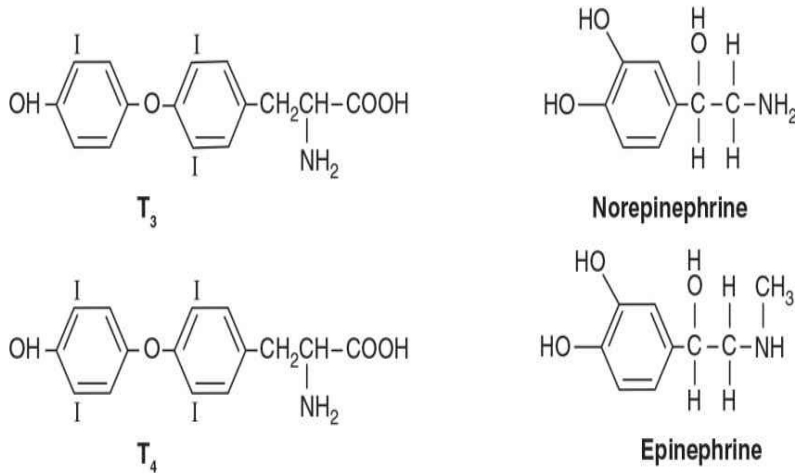

C. Peptides of various sizes

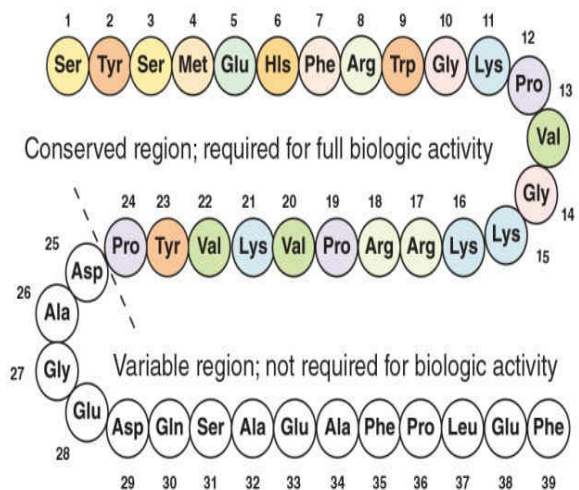
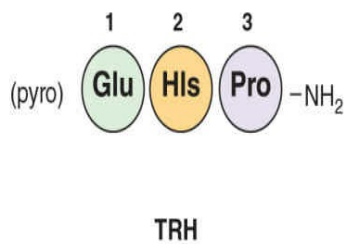

D. Glycoproteins (TSH, FSH, LH)

common α subunits

unique β subunits

FIGURE 41–2 Chemical diversity of hormones. (A) cholesterol derivatives; (B) tyrosine derivatives; (C) peptides of various sizes; note: pyroglutamic acid (pyro) is a cyclized variant of glutamic acid in which side chain carboxyl and free amino groups cyclize to form a lactam. (D) glycoproteins (TSH, FSH, and LH) with common α subunits and unique β subunits.

The amino acid tyrosine is the starting point in the synthesis of both the catecholamines and thyroid hormones tetraiodothyronine (thyroxine; T_4) and triiodothyronine (T_3) (Figure 41–2). T_3 and T_4 are unique in that they require the addition of iodine (as I^-) for bioactivity. Since dietary iodine is very scarce in many parts of the world, an intricate mechanism for accumulating and retaining I^- has evolved.

Many hormones are polypeptides or glycoproteins. These range in size from the small thyrotropin-releasing hormone (TRH), a tripeptide, to single-chain polypeptides like adrenocorticotrophic hormone (ACTH; 39 amino acids), parathyroid hormone (PTH; 84 amino acids), and growth hormone (GH; 191 amino acids) (Figure 41–2). Insulin is an A-B chain heterodimer of 21 and 30 amino acids, respectively. Follicle-stimulating hormone (FSH), luteinizing hormone (LH), thyroid-stimulating hormone (TSH), and chorionic gonadotropin (CG) are glycoprotein hormones of $\alpha\beta$ heterodimeric structure. The α chain is identical in all of these hormones, and distinct β chains impart hormone uniqueness. These hormones have a molecular mass in the range of 25 to 30 kDa depending on the degree of glycosylation and the length of the β chain.

Hormones Are Synthesized & Modified for Full Activity in a Variety of Ways

Some hormones are synthesized in final form and secreted immediately. Included in this class are hormones derived from cholesterol. Some, such as the catecholamines, are synthesized in final form and stored in the producing cells, while others, like insulin, are synthesized as precursor molecules in the producing cell, and then are processed and secreted upon a physiologic cue (plasma glucose concentrations). Finally, still others are converted to active forms from precursor molecules in the peripheral tissues (T_3 and DHT). All of these examples are discussed in more detail below.

MANY HORMONES ARE MADE FROM CHOLESTEROL

Adrenal Steroidogenesis

The adrenal steroid hormones are synthesized from cholesterol, which is mostly derived from the plasma, but a small portion is synthesized in situ from acetyl-CoA via mevalonate and squalene. Much of the cholesterol in the adrenal is esterified and stored in cytoplasmic lipid droplets. Upon stimulation of the adrenal by ACTH, an esterase is activated, and the free cholesterol formed is transported into the mitochondrion, where a **cytochrome P450 side chain cleavage enzyme (P450_{scc})** converts cholesterol to pregnenolone. Cleavage of the side chain involves sequential hydroxylations, first at C₂₂ and then at C₂₀, followed by side chain cleavage (removal of the six-carbon fragment isocaproaldehyde) to give the 21-carbon steroid (**Figure 41–3**, top). An ACTH-dependent **steroidogenic acute regulatory (StAR) protein** is essential for the transport of cholesterol to P450_{scc} in the inner mitochondrial membrane.

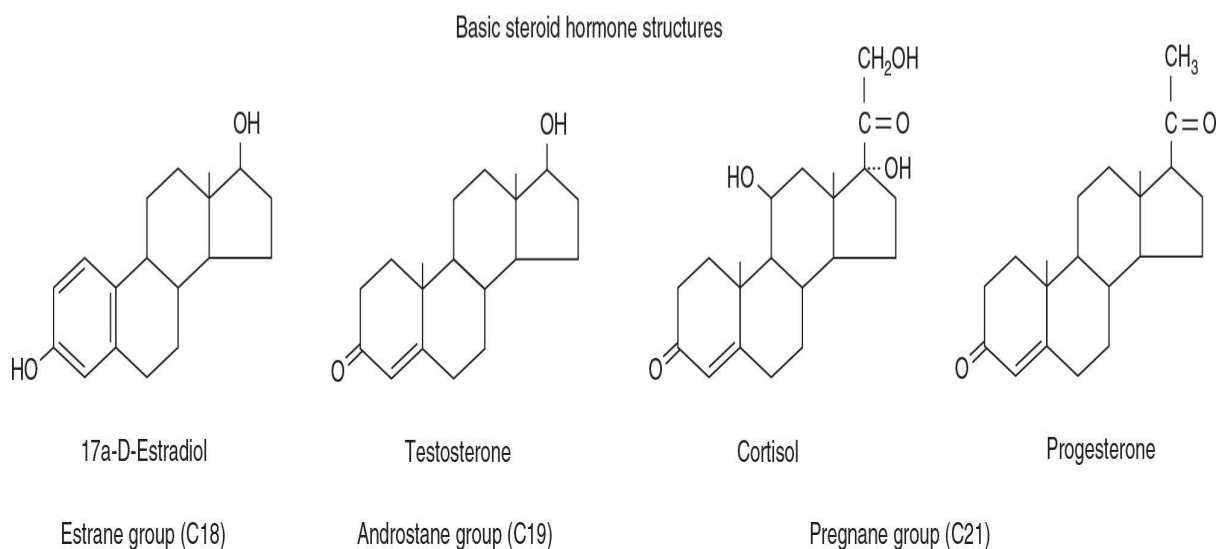
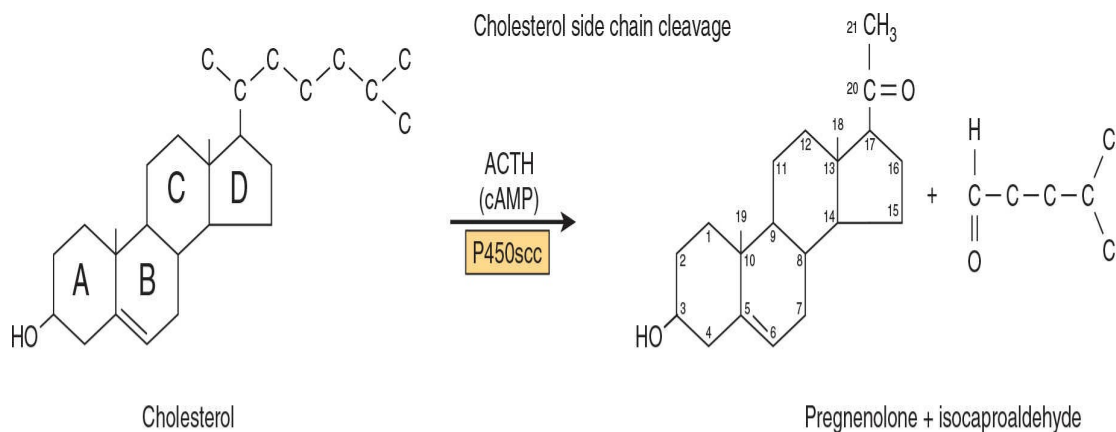

FIGURE 41–3 Cholesterol side chain cleavage and basic steroid hormone structures. The basic sterol rings are identified by the letters A to D. The carbon atoms are numbered 1 to 21, starting with the A ring (see Figure 26–3).

All mammalian steroid hormones are formed from cholesterol via pregnenolone through a series of reactions that occur in either the mitochondria or endoplasmic reticulum of the producing cell. Hydroxylases that require molecular oxygen and NADPH are essential, and dehydrogenases, an isomerase, and a lyase reaction are also necessary for certain steps. There is cellular specificity in adrenal steroidogenesis. For instance, 18-hydroxylase and 19-hydroxysteroid dehydrogenases, which are required for aldosterone synthesis, are found only in the zona glomerulosa cells (the outer region of the adrenal cortex), so that the

biosynthesis of this mineralocorticoid is confined to this region. A schematic representation of the pathways involved in the synthesis of the three major classes of adrenal steroids is presented in **Figure 41-4**. The enzymes are shown in the rectangular boxes, and the modifications at each step are shaded.

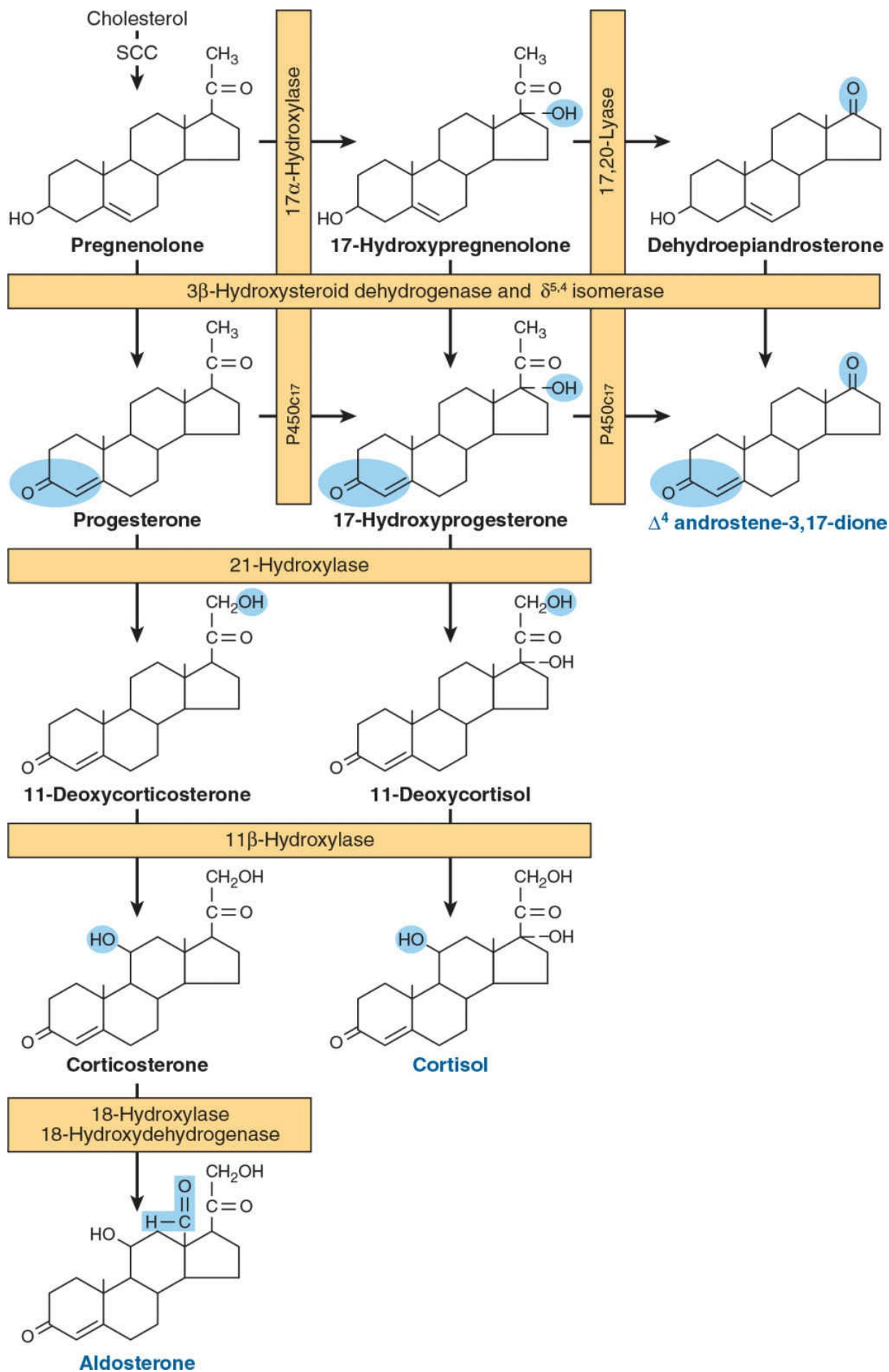

FIGURE 41–4 Pathways involved in the synthesis of the three major classes of adrenal steroids (mineralocorticoids, glucocorticoids, and androgens). Enzymes are shown in the rectangular boxes, and the modifications at each step are shaded. Note that the 17 α -hydroxylase and 17,20-lyase activities are both part of one enzyme, designated P450c17. (Slightly modified and reproduced, with permission, from Harding BW: In: *Endocrinology*, vol 2. DeGroot LJ (editor). Grune & Stratton, 1979. Copyright © 1979 Elsevier Inc. Reprinted with permission from Elsevier.)

Mineralocorticoid Synthesis

Synthesis of aldosterone follows the mineralocorticoid pathway and occurs in the zona glomerulosa. Pregnenolone is converted to progesterone by the action of two smooth endoplasmic reticulum enzymes, **3 β -hydroxysteroid dehydrogenase (3 β -OHS)** and **Δ 5,4-isomerase**. Progesterone is hydroxylated at the C₂₁ position to form 11-deoxycorticosterone (DOC), which is an active (Na⁺-retaining) mineralocorticoid. The next hydroxylation, at C₁₁, produces corticosterone, which has glucocorticoid activity and is a weak mineralocorticoid (it has <5% of the potency of aldosterone). In some species (eg, rodents), it is the most potent glucocorticoid. C₂₁ hydroxylation is necessary for both mineralocorticoid and glucocorticoid activity, but most steroids with a C₁₇ hydroxyl group have more glucocorticoid and less mineralocorticoid action. In the zona glomerulosa, which does not have the smooth endoplasmic reticulum enzyme 17 α -hydroxylase, a mitochondrial 18-hydroxylase is present. The **18-hydroxylase (aldosterone synthase)** acts on corticosterone to form 18-hydroxycorticosterone, which is changed to aldosterone by conversion of the 18-alcohol to an aldehyde. This unique distribution of enzymes and the special regulation of the zona glomerulosa by K⁺ and angiotensin II have led some investigators to suggest that, in addition to the adrenal being two glands, the adrenal cortex is actually two separate organs.

Glucocorticoid Synthesis

Cortisol synthesis requires three hydroxylases located in the fasciculata and reticularis zones of the adrenal cortex that act sequentially on the C₁₇, C₂₁, and C₁₁ positions. The first two reactions are rapid, while C₁₁ hydroxylation is relatively slow. If the C₁₁ position is hydroxylated first, the action of **17 α -hydroxylase** is impeded, and the mineralocorticoid

pathway is followed (forming corticosterone or aldosterone, depending on the cell type). 17 α -Hydroxylase is a smooth endoplasmic reticulum enzyme that acts on either progesterone or, more commonly, pregnenolone. 17 α -Hydroxyprogesterone is hydroxylated at C₂₁ to form 11-deoxycortisol, which is then hydroxylated at C₁₁ to form cortisol, the most potent natural glucocorticoid hormone in humans. 21-Hydroxylase is a smooth endoplasmic reticulum enzyme, whereas 11 β -hydroxylase is a mitochondrial enzyme. Steroidogenesis thus involves the repeated shuttling of substrates into and out of the mitochondria.

Androgen Synthesis

The major androgen or androgen precursor produced by the adrenal cortex is dehydroepiandrosterone (DHEA). Most 17-hydroxypregnenolone follows the glucocorticoid pathway, but a small fraction is subjected to oxidative fission and removal of the two-carbon side chain through the action of 17,20-lyase. The lyase activity is actually part of the same enzyme (P450c17) that catalyzes 17 α -hydroxylation. This is therefore a **dual-function protein**. The lyase activity is important in both the adrenals and the gonads and acts exclusively on 17 α -hydroxy-containing molecules. Adrenal androgen production increases markedly if glucocorticoid biosynthesis is impeded by the lack of one of the hydroxylases (**adrenogenital syndrome**). DHEA is really a prohormone since the actions of 3 β -OHSD and $\Delta^{5,4}$ -isomerase convert the weak androgen DHEA into the more potent **androstenedione**. Small amounts of androstenedione are also formed in the adrenal by the action of the lyase on 17 α -hydroxyprogesterone. Reduction of androstenedione at the C₁₇ position results in the formation of **testosterone**, the most potent adrenal androgen. Small amounts of testosterone are produced in the adrenal by this mechanism, but most of this conversion occurs in the testes.

Testicular Steroidogenesis

Testicular androgens are synthesized in the interstitial tissue by the Leydig cells. The immediate precursor of the gonadal steroids, as for the adrenal steroids, is cholesterol. The rate-limiting step, as in the adrenal, is delivery of cholesterol to the inner membrane of the mitochondria by the transport protein StAR. Once in the proper location, cholesterol is acted upon by the side chain cleavage enzyme P450scc. The conversion of cholesterol to pregnenolone is identical in adrenal, ovary, and testis. In the latter two

tissues, however, the reaction is promoted by LH rather than ACTH.

The conversion of pregnenolone to testosterone requires the action of five enzyme activities contained in three proteins: (1) 3β -hydroxysteroid dehydrogenase (3β -OHD) and $\Delta^{5,4}$ -isomerase; (2) 17α -hydroxylase and $17,20$ -lyase; and (3) 17β -hydroxysteroid dehydrogenase (17β -OHD). This sequence, referred to as the **progesterone (or $\Delta 4$)** pathway, is shown on the right side of **Figure 41–5**. Pregnenolone can also be converted to testosterone by the **dehydroepiandrosterone (or $\Delta 5$)** pathway, which is illustrated on the left side of **Figure 41–5**. The $\Delta 5$ route appears to be most used in human testes.

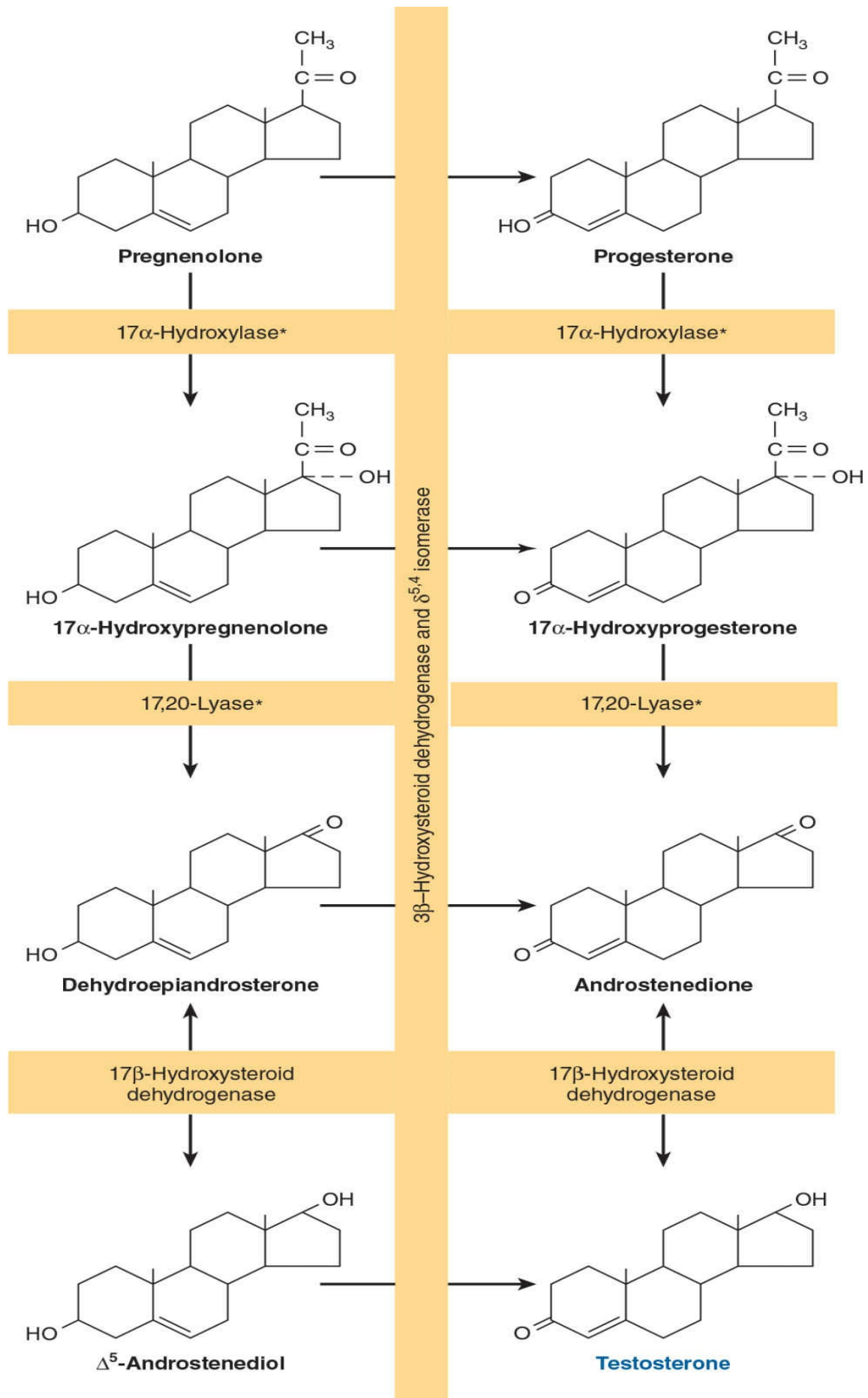

FIGURE 41–5 Pathways of testosterone biosynthesis. The pathway on the left side of the figure is called the Δ^5 or dehydroepiandrosterone pathway; the pathway on the right side is called the Δ^4 or progesterone pathway. The asterisk indicates that the 17 α -hydroxylase and 17,20-lyase activities reside in a single protein, P450c17.

The five enzyme activities are localized in the microsomal fraction in rat testes, and there is a close functional association between the activities of 3 β -OHSD and $\Delta^{5,4}$ -isomerase and between those of a 17 α -hydroxylase and 17,20-lyase. These enzyme pairs, both contained in a single protein, are shown in the general reaction sequence in [Figure 41–5](#).

DHT Is Formed From Testosterone in Peripheral Tissues

Testosterone is metabolized by two pathways. One involves oxidation at the 17-position, and the other involves reduction of the A ring double bond and the 3-ketone. Metabolism by the first pathway occurs in many tissues, including liver, and produces 17-ketosteroids that are generally inactive or less active than the parent compound. Metabolism by the second pathway, which is less efficient, occurs primarily in target tissues and produces the potent metabolite DHT.

The most significant metabolic product of testosterone is DHT, since in many tissues, including prostate, external genitalia, and some areas of the skin, this is the active form of the hormone. The plasma content of DHT in the adult male is about one-tenth that of testosterone, and ~400 μg of DHT is produced daily as compared with about 5 mg of testosterone. About 50 to 100 μg of DHT are secreted by the testes. The rest is produced peripherally from testosterone in a reaction catalyzed by the NADPH-dependent **5 α -reductase** ([Figure 41–6](#)). Testosterone can thus be considered a prohormone since it is converted into a much more potent compound (DHT) and since most of this conversion occurs outside the testes. Some estradiol is formed from the peripheral aromatization of testosterone, particularly in males.

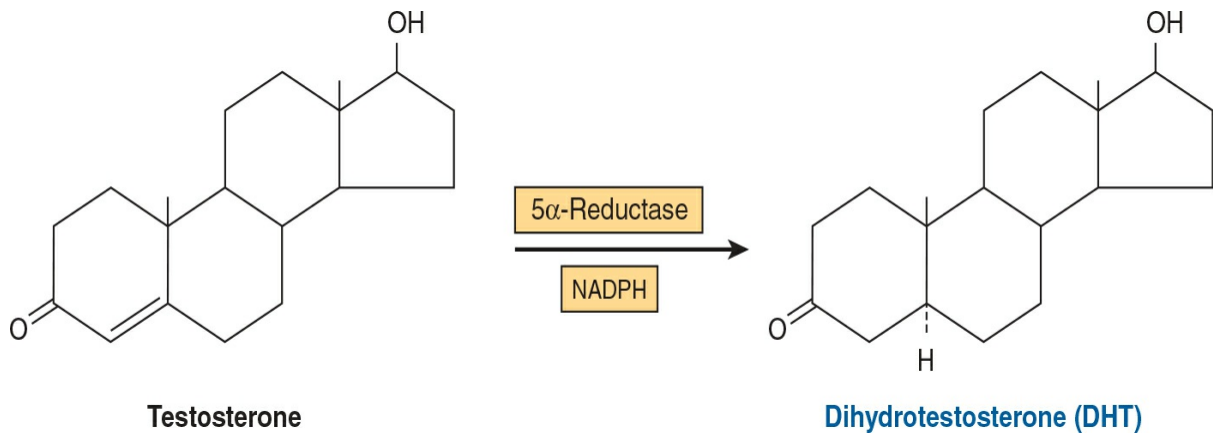

FIGURE 41–6 Dihydrotestosterone is formed from testosterone through action of the enzyme 5 α -reductase.

Ovarian Steroidogenesis

The estrogens are a family of hormones synthesized in a variety of tissues. 17 β -Estradiol is the primary estrogen of ovarian origin. In some species, estrone, synthesized in numerous tissues, is more abundant. In pregnancy, relatively more estriol is produced, and this comes from the placenta. The general pathway and the subcellular localization of the enzymes involved in the early steps of estradiol synthesis are the same as those involved in androgen biosynthesis. Features unique to the ovary are illustrated in **Figure 41–7**.

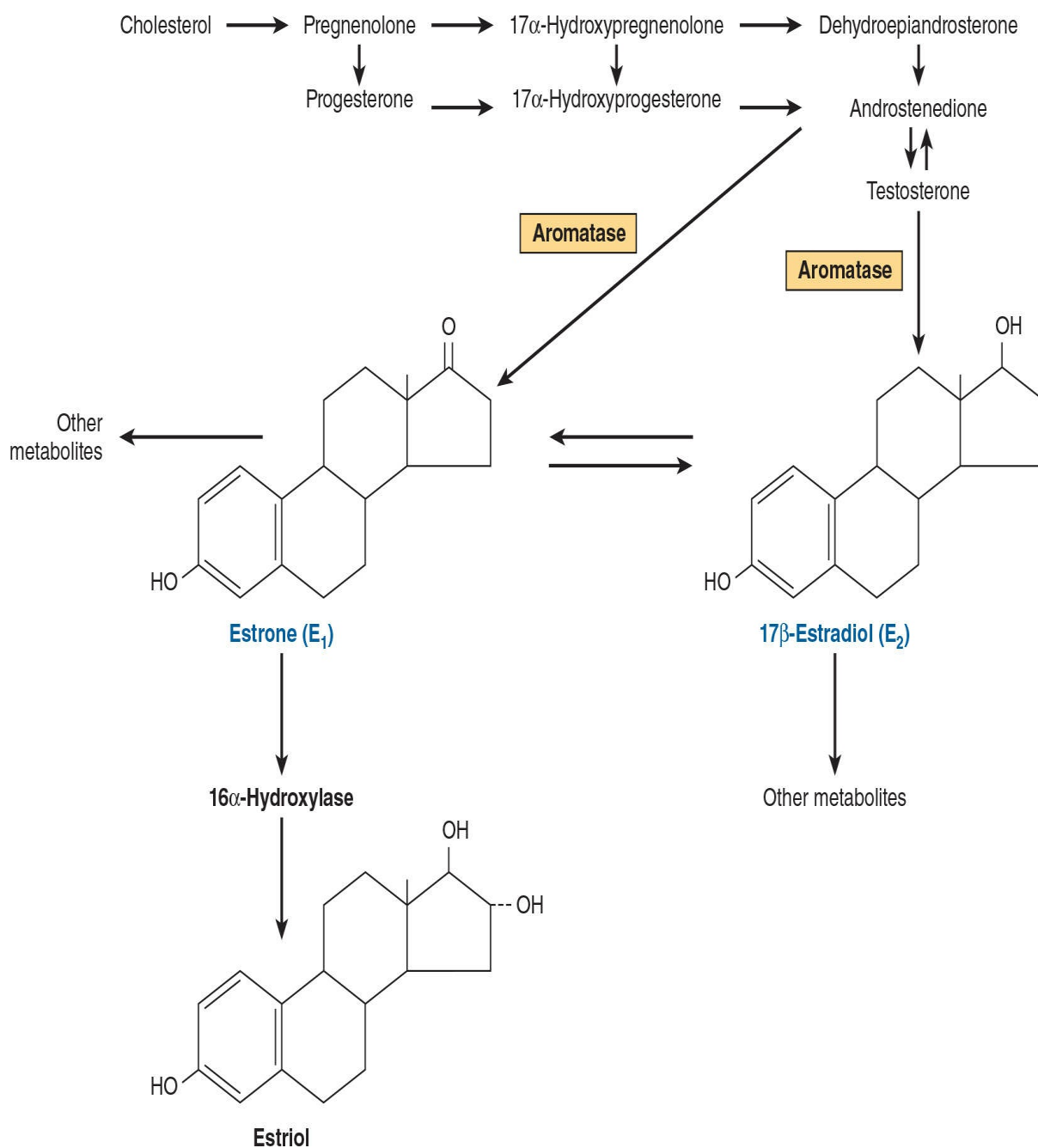

FIGURE 41–7 Biosynthesis of estrogens. (Slightly modified and reproduced, with permission, from Ganong WF: *Review of Medical Physiology*, 21st ed. McGraw-Hill, 2005.)

Estrogens are formed by the aromatization of androgens in a complex process that involves three hydroxylation steps, each of which requires O₂ and NADPH. The **aromatase enzyme complex** is thought to include a P450 monooxygenase. Estradiol is formed if the substrate of this enzyme complex is testosterone, whereas estrone results from the aromatization of androstenedione.

The cellular source of the various ovarian steroids has been difficult to unravel, but a transfer of substrates between two cell types is involved. Theca cells are the source of androstenedione and testosterone. These are converted by the aromatase enzyme in granulosa cells to estrone and estradiol, respectively. Progesterone, a precursor for all steroid hormones, is produced and secreted by the corpus luteum as an end-product hormone because these cells do not contain the enzymes necessary to convert progesterone to other steroid hormones (**Figure 41–8**).

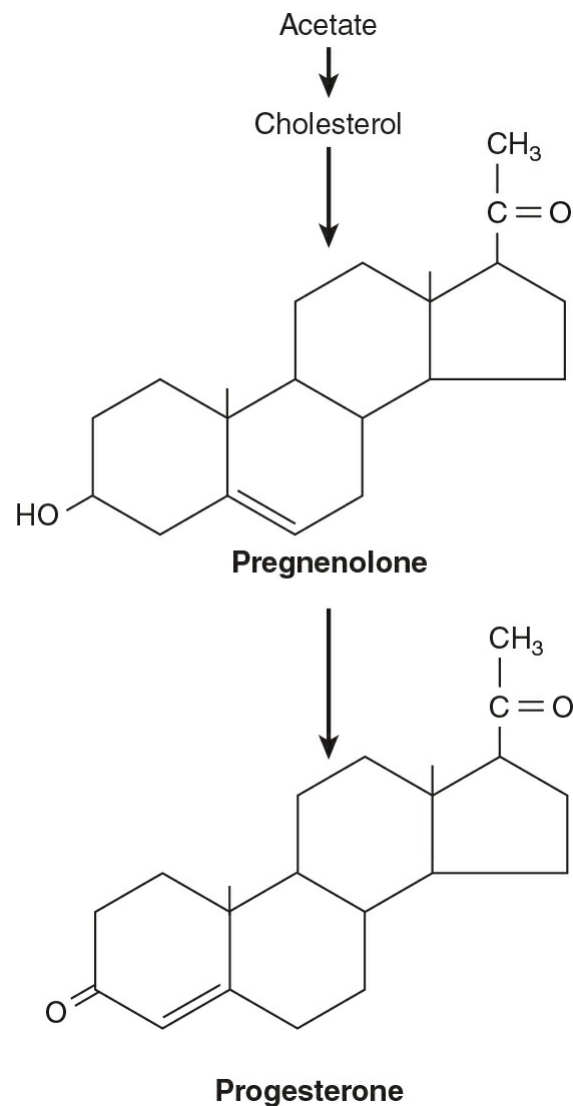

FIGURE 41–8 Biosynthesis of progesterone in the corpus luteum.

Significant amounts of estrogens are produced by the peripheral aromatization of androgens. In human males, the peripheral aromatization of testosterone to estradiol (E₂) accounts for 80% of the production of the latter. In females, adrenal androgens are important substrates since as

much as 50% of the E_2 produced during pregnancy comes from the aromatization of androgens. Finally, conversion of androstenedione to estrone is the major source of estrogens in postmenopausal women. Aromatase activity is present in adipose cells and also in liver, skin, and other tissues. Increased activity of this enzyme may contribute to the “estrogenization” that characterizes such diseases as cirrhosis of the liver, hyperthyroidism, aging, and obesity. Aromatase inhibitors show promise as therapeutic agents in breast cancer and possibly in other female reproductive tract malignancies.

1,25(OH)₂-D₃ (Calcitriol) Is Synthesized From a Cholesterol Derivative

1,25(OH)₂-D₃ is produced by a complex series of enzymatic reactions that involve the plasma transport of precursor molecules to a number of different tissues (**Figure 41–9**). One of these precursors is vitamin D—really not a vitamin, but this common name persists. The active molecule, 1,25(OH)₂-D₃, is transported to other organs where it activates biologic processes in a manner similar to that employed by the steroid hormones.

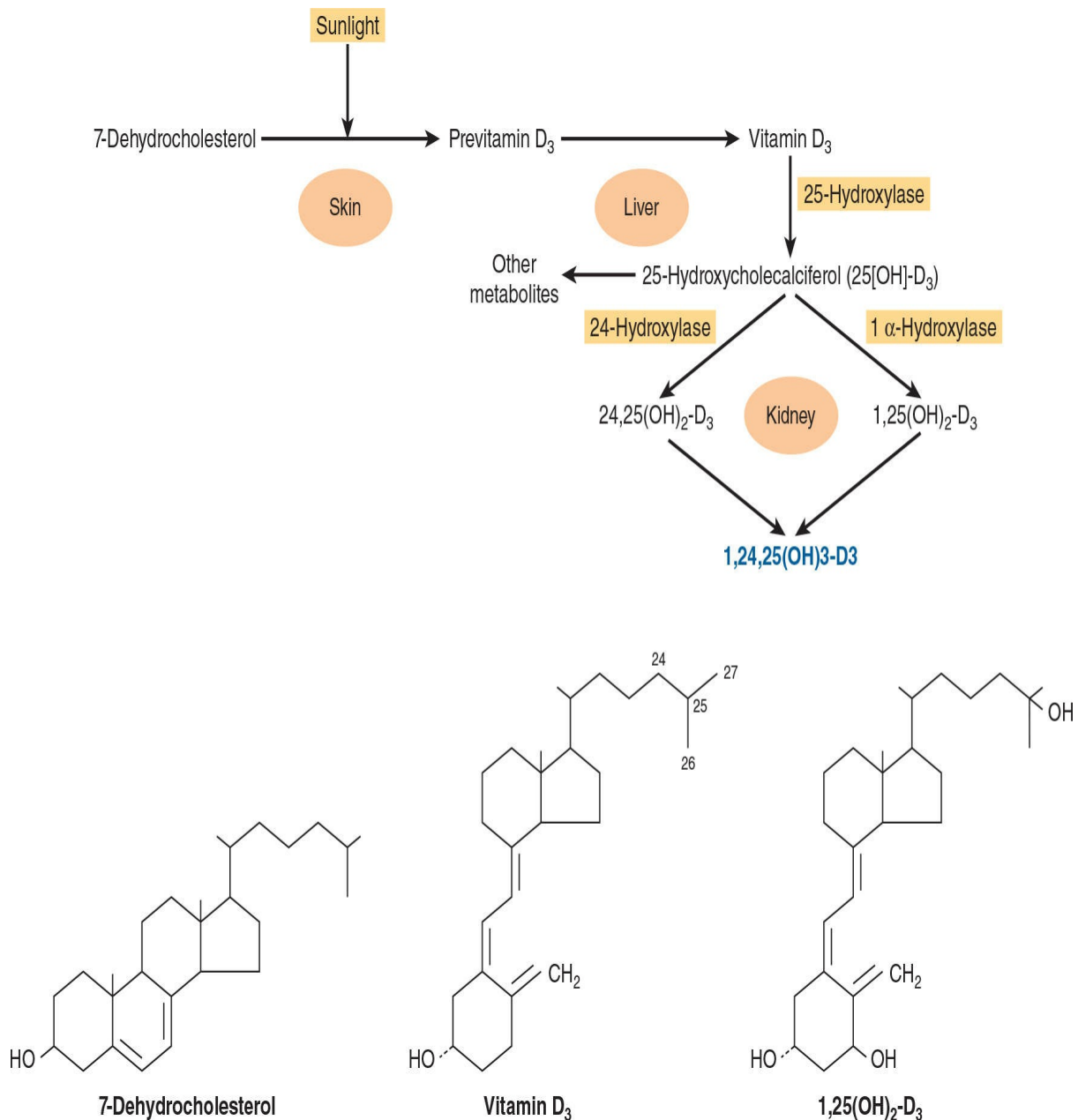

FIGURE 41–9 Formation and hydroxylation of vitamin D₃. 25-Hydroxylation takes place in the liver, and the other hydroxylations occur in the kidneys. 25,26(OH)₂-D₃ and 1,25,26(OH)₃-D₃ are probably formed as well. The structures of 7-dehydrocholesterol, vitamin D₃, and 1,25(OH)₂-D₃ are also shown. (Modified and reproduced, with permission, from Ganong WF: *Review of Medical Physiology*, 21st ed. McGraw-Hill, 2005.)

Skin

Small amounts of the precursor for 1,25(OH)₂-D₃ synthesis are present in

food (fish liver oil, and egg yolk), but most of the precursor for 1,25(OH)₂-D₃ synthesis is produced in the malpighian layer of the epidermis from 7-dehydrocholesterol in an ultraviolet light-mediated, nonenzymatic **photolysis** reaction. The extent of this conversion is related directly to the intensity of the exposure and inversely to the extent of pigmentation in the skin. There is an age-related loss of 7-dehydrocholesterol in the epidermis that may be related to the negative calcium balance associated with old age.

Liver

A specific transport protein called the **vitamin D-binding protein** binds vitamin D₃ and its metabolites and moves vitamin D₃ from the skin or intestine to the liver, where it undergoes 25-hydroxylation, the first obligatory reaction in the production of 1,25(OH)₂-D₃. 25-Hydroxylation occurs in the endoplasmic reticulum in a reaction that requires magnesium, NADPH, molecular oxygen, and an uncharacterized cytoplasmic factor. Two enzymes are involved: an NADPH-dependent cytochrome P450 reductase and a cytochrome P450. This reaction is not regulated, and it also occurs with low efficiency in kidney and intestine. The 25(OH)₂-D₃ enters the circulation, where it is the major form of vitamin D found in plasma, and is transported to the kidney by the vitamin D-binding protein.

Kidney

25(OH)₂-D₃ is a weak agonist and must be modified by hydroxylation at position C₁ for full biologic activity. This is accomplished in mitochondria of the renal proximal convoluted tubule by a three-component monooxygenase reaction that requires NADPH, Mg²⁺, molecular oxygen, and at least three enzymes: (1) a flavoprotein, renal ferredoxin reductase; (2) an iron-sulfur protein, renal ferredoxin; and (3) cytochrome P450. This system produces 1,25(OH)₂-D₃, which is the most potent naturally occurring metabolite of vitamin D.

CATECHOLAMINES & THYROID HORMONES ARE MADE FROM TYROSINE

Catecholamines Are Synthesized in Final Form & Stored in Secretion Granules

Three amines—dopamine, norepinephrine, and epinephrine—are synthesized from tyrosine in the chromaffin cells of the adrenal medulla. The major product of the adrenal medulla is epinephrine. This compound constitutes about 80% of the catecholamines in the medulla, and it is not made in extramedullary tissue. In contrast, most of the norepinephrine present in organs innervated by sympathetic nerves is made in situ (about 80% of the total), and most of the rest is made in other nerve endings and reaches the target sites via the circulation. Epinephrine and norepinephrine may be produced and stored in different cells in the adrenal medulla and other chromaffin tissues.

The conversion of tyrosine to epinephrine requires four sequential steps: (1) ring hydroxylation; (2) decarboxylation; (3) side chain hydroxylation to form norepinephrine; and (4) *N*-methylation to form epinephrine. The biosynthetic pathway and the enzymes involved are illustrated in **Figure 41–10**.

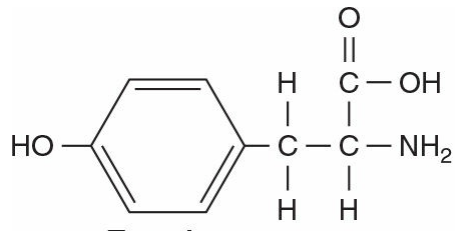

Tyrosine hydroxylase

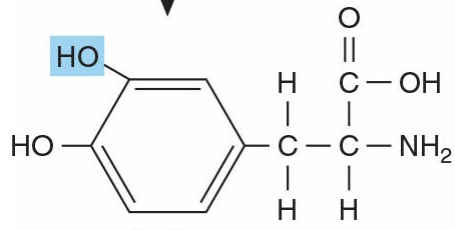

Dopa decarboxylase

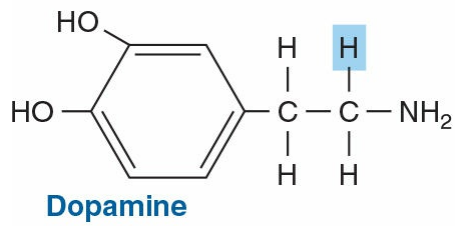

Dopamine β -hydroxylase

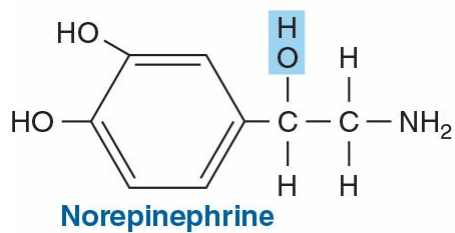

PNMT

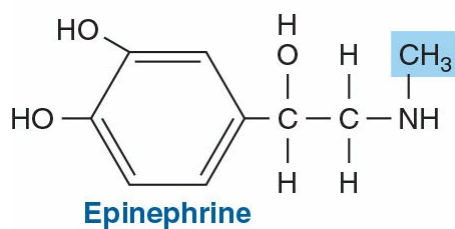

FIGURE 41–10 Biosynthesis of catecholamines. (PNMT, phenylethanolamine-*N*-methyltransferase.)

Tyrosine Hydroxylase Is Rate-Limiting for Catecholamine Biosynthesis

Tyrosine is the immediate precursor of catecholamines, and **tyrosine hydroxylase** is the rate-limiting enzyme in catecholamine biosynthesis. Tyrosine hydroxylase is found in both soluble and particle-bound forms only in tissues that synthesize catecholamines; it functions as an oxidoreductase, with tetrahydropteridine as a cofactor, to convert L-tyrosine to L-dihydroxyphenylalanine (**L-dopa**). As the rate-limiting enzyme, tyrosine hydroxylase is regulated in a variety of ways. The most important mechanism involves feedback inhibition by the catecholamines, which compete with the enzyme for the pteridine cofactor. Catecholamines cannot cross the blood–brain barrier; hence, in the brain they must be synthesized locally. In certain central nervous system diseases (eg, Parkinson disease), there is a local deficiency of dopamine synthesis. L-Dopa, the precursor of dopamine, readily crosses the blood–brain barrier and so is an important agent in the treatment of Parkinson disease.

Dopa Decarboxylase Is Present in All Tissues

This soluble enzyme requires pyridoxal phosphate for the conversion of L-dopa to 3,4-dihydroxyphenylethylamine (**dopamine**). Compounds that resemble L-dopa, such as α -methyldopa, are competitive inhibitors of this reaction. α -Methyldopa is effective in treating some kinds of hypertension.

Dopamine β -Hydroxylase (DBH) Catalyzes the Conversion of Dopamine to Norepinephrine

DBH is a monooxygenase and uses ascorbate as an electron donor, copper at the active site, and fumarate as modulator. DBH is in the particulate fraction of the medullary cells, probably in the secretion granule; thus, the conversion of dopamine to **norepinephrine** occurs in this organelle.

Phenylethanolamine-*N*-Methyltransferase (PNMT) Catalyzes the Production of Epinephrine

PNMT catalyzes the *N*-methylation of norepinephrine to form **epinephrine** in the epinephrine-forming cells of the adrenal medulla. Since PNMT is soluble, it is assumed that norepinephrine-to-epinephrine

conversion occurs in the cytoplasm. The synthesis of PNMT is induced by glucocorticoid hormones that reach the medulla via the intra-adrenal portal system. This special system provides for a 100-fold steroid concentration gradient over systemic arterial blood, and this high intra-adrenal concentration appears to be necessary for the induction of PNMT.

T₃ & T₄ Illustrate the Diversity in Hormone Synthesis

The formation of **triiodothyronine (T₃)** and **tetraiodothyronine (thyroxine; T₄)** (see [Figure 41–2](#)) illustrates many of the principles of diversity discussed in this chapter. These hormones require a rare element (iodine) for bioactivity; they are synthesized as part of a very large precursor molecule (thyroglobulin); they are stored in an intracellular reservoir (colloid); and there is peripheral conversion of T₄ to T₃, which is a much more active hormone.

The thyroid hormones T₃ and T₄ are unique in that iodine (as iodide) is an essential component of both. In most parts of the world, iodine is a scarce component of soil, and for that reason there is little in food. A complex mechanism has evolved to acquire and retain this crucial element and to convert it into a form suitable for incorporation into organic compounds. At the same time, the thyroid must synthesize thyronine from tyrosine, and this synthesis takes place in thyroglobulin ([Figure 41–11](#)).

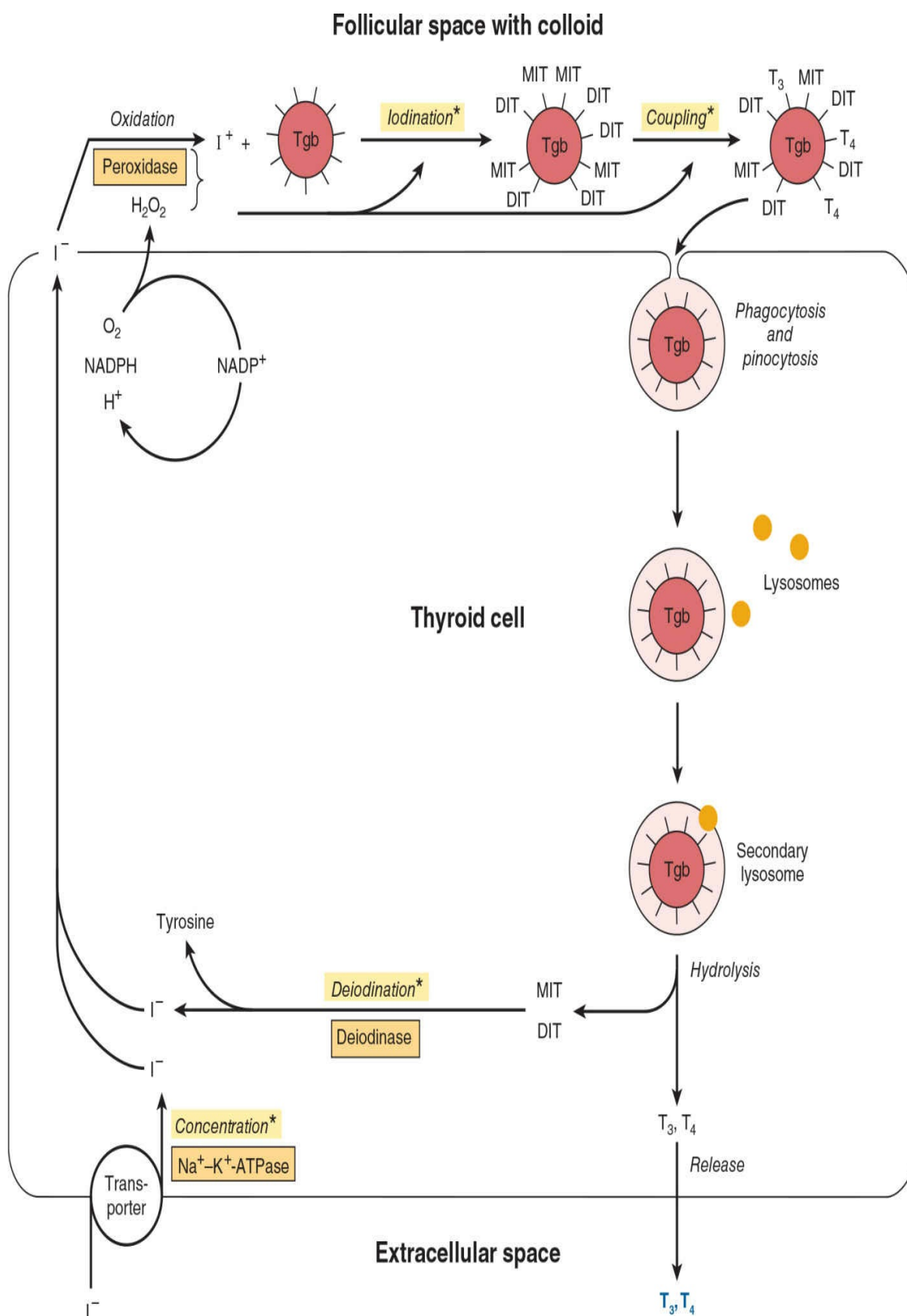

FIGURE 41–11 Model of iodide metabolism in the thyroid follicle. A follicular cell is shown facing the follicular lumen (top) and the

extracellular space (**bottom**). Iodide enters the thyroid primarily through a transporter (bottom left). Thyroid hormone synthesis occurs in the follicular space through a series of reactions, many of which are peroxidase-mediated. Thyroid hormones, stored in the colloid in the follicular space, are released from thyroglobulin by hydrolysis inside the thyroid cell. (DIT, diiodotyrosine; MIT, monoiodotyrosine; Tgb, thyroglobulin; T₃, triiodothyronine; T₄, tetraiodothyronine; T₃ and T₄ structures are shown in [Figure 41–2B](#).) Asterisks indicate steps or processes where inherited enzyme deficiencies cause congenital goiter and often result in hypothyroidism.

Thyroglobulin is the precursor of T₄ and T₃. It is a large iodinated, glycosylated protein with a molecular mass of 660 kDa. Carbohydrate accounts for 8 to 10% of the weight of thyroglobulin and iodide for about 0.2 to 1%, depending on the iodine content in the diet. Thyroglobulin is composed of two large subunits. It contains 115 tyrosine residues, each of which is a potential site of iodination. About 70% of the iodide in thyroglobulin exists in the inactive precursors, **monoiodotyrosine (MIT)** and **diiodotyrosine (DIT)**, while 30% is in the **iodothyronyl residues**, T₄ and T₃. When iodine supplies are sufficient, the T₄:T₃ ratio is about 7:1. In **iodine deficiency**, this ratio decreases, as does the DIT:MIT ratio. Thyroglobulin, a large molecule of about 5000 amino acids, provides the conformation required for tyrosyl coupling and iodide organification necessary in the formation of the diaminoacid thyroid hormones. It is synthesized in the basal portion of the cell and moves to the lumen, where it is a storage form of T₃ and T₄ in the colloid; several weeks' supply of these hormones exist in the normal thyroid. Within minutes after stimulation of the thyroid by TSH, colloid reenters the cell and there is a marked increase of phagolysosome activity. Various acid proteases and peptidases hydrolyze the thyroglobulin into its constituent amino acids, including T₄ and T₃, which are discharged into the extracellular space ([Figure 41–11](#)). Thyroglobulin is thus a very large prohormone.

Iodide Metabolism Involves Several Discrete Steps

The thyroid is able to concentrate I⁻ against a strong electrochemical gradient. This is an energy-dependent process and is linked to the Na⁺-K⁺-ATPase-dependent thyroidal I⁻ transporter. The ratio of iodide in thyroid to iodide in serum (T:S ratio) is a reflection of the activity of this

transporter. This activity is primarily controlled by TSH and ranges from 500:1 in animals chronically stimulated with TSH to 5:1 or less in hypophysectomized animals (no TSH). The T:S ratio in humans on a normal iodine diet is about 25:1.

The thyroid is the only tissue that can oxidize I^- to a higher valence state, an obligatory step in I^- organification and thyroid hormone biosynthesis. This step involves a heme-containing peroxidase and occurs at the luminal surface of the follicular cell. Thyroperoxidase, a tetrameric protein with a molecular mass of 60 kDa, requires hydrogen peroxide (H_2O_2) as an oxidizing agent. The H_2O_2 is produced by an NADPH-dependent enzyme resembling cytochrome *c* reductase. A number of compounds inhibit I^- oxidation and therefore its subsequent incorporation into MIT and DIT. The most important of these are the thiourea drugs. They are used as antithyroid drugs because of their ability to inhibit thyroid hormone biosynthesis at this step. Once iodination occurs, the iodine does not readily leave the thyroid. Free tyrosine can be iodinated, but it is not incorporated into proteins since no tRNA recognizes iodinated tyrosine.

The coupling of two DIT molecules to form T_4 —or of an MIT and DIT to form T_3 —occurs within the thyroglobulin molecule. A separate coupling enzyme has not been found, and since this is an oxidative process, it is assumed that the same thyroperoxidase catalyzes this reaction by stimulating free radical formation of iodotyrosine. This hypothesis is supported by the observation that the same drugs which inhibit I^- oxidation also inhibit coupling. The formed thyroid hormones remain as integral parts of thyroglobulin until the latter is degraded, as described above.

A deiodinase removes I^- from the inactive mono and diiodothyronine molecules in the thyroid. This mechanism provides a substantial amount of the I^- used in T_3 and T_4 biosynthesis. A peripheral deiodinase in target tissues such as pituitary, kidney, and liver selectively removes I^- from the 5' position of T_4 to make T_3 (Figure 41–2), which is a much more active molecule. In this sense, T_4 can be thought of as a prohormone, though it does have some intrinsic activity.

Several Hormones Are Made From Larger Peptide

Precursors

Formation of the critical disulfide bridges in insulin requires that this hormone be first synthesized as part of a larger precursor molecule, proinsulin. This is conceptually similar to the example of the thyroid hormones, which can only be formed in the context of a much larger molecule. Several other hormones are synthesized as parts of large precursor molecules, not because of some special structural requirement but rather as a mechanism for controlling the available amount of the active hormone. PTH and angiotensin II are examples of this type of regulation. Another interesting example is the pro-opiomelanocortin (POMC) protein, which can be processed into many different hormones in a tissue-specific manner. These examples are discussed in detail below.

Insulin Is Synthesized as a Preprohormone & Modified Within the β Cell

Insulin has an AB heterodimeric structure with one intrachain (A6-A11) and two interchain disulfide bridges (A7-B7 and A20-B19) (**Figure 41–12**). The A and B chains could be synthesized in the laboratory, but attempts at a biochemical synthesis of the mature insulin molecule yielded very poor results. The reason for this became apparent when it was discovered that insulin is synthesized as a **preprohormone** (molecular weight $\sim 11,500$), which is the prototype for peptides that are processed from larger precursor molecules. The hydrophobic 23-amino-acid pre-, or leader, sequence directs the molecule into the cisternae of the endoplasmic reticulum and then is removed. This results in the 9000-MW proinsulin molecule, which provides the conformation necessary for the proper and efficient formation of the disulfide bridges. As shown in **Figure 41–12**, the sequence of proinsulin, starting from the amino terminus, is B chain—connecting (C) peptide—A chain. The proinsulin molecule undergoes a series of site-specific peptide cleavages that result in the formation of equimolar amounts of mature insulin and C-peptide. These enzymatic cleavages are summarized in **Figure 41–12**.

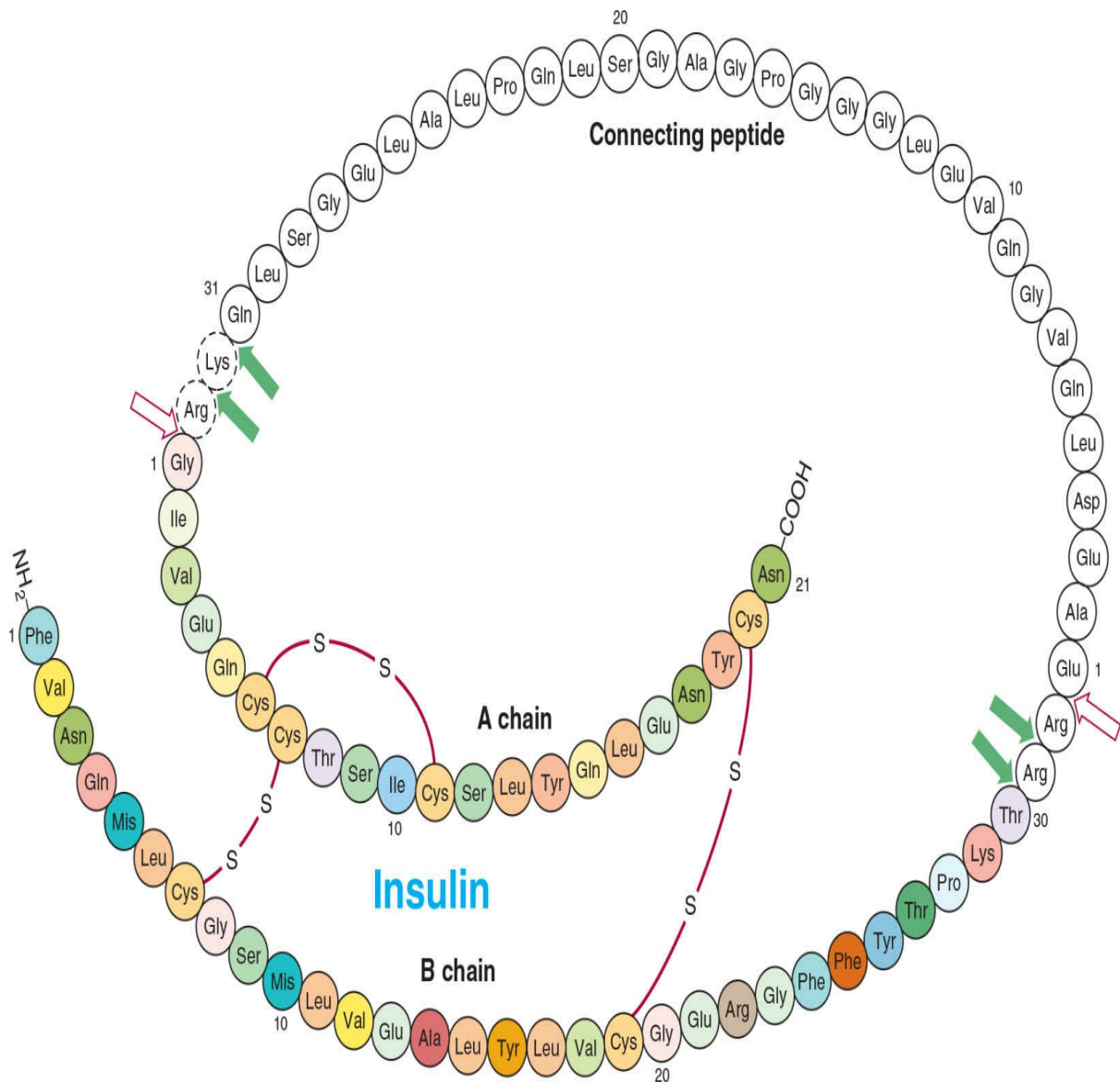

FIGURE 41-12 Structure of human proinsulin. Insulin and C-peptide molecules are connected at two sites by peptide bonds. An initial cleavage by a trypsin-like enzyme (red open arrows) followed by several cleavages by a carboxypeptidase-like enzyme (green solid arrows) results in the production of the heterodimeric (AB) insulin molecule (colored), which is held together by two intrapeptide cysteine disulfide bonds; insulin C-peptide (white).

PTH Is Secreted as an 84-Amino-Acid Peptide

The immediate precursor of **parathyroid (PTH)** is **proPTH**, which differs from the native 84-amino-acid hormone by having a highly basic hexapeptide amino terminal extension. The primary gene product and the immediate precursor for proPTH is the 115-amino-acid **preproPTH**. This

differs from proPTH by having an additional 25-amino-acid NH₂-terminal extension that is common with the other leader or signal sequences characteristic of secreted proteins; it is predominantly hydrophobic in nature. The complete structure of preproPTH and the sequences of proPTH and PTH are illustrated in **Figure 41–13**. PTH_{1–34} has full biologic activity, and the region 25 to 34 is primarily responsible for receptor binding.

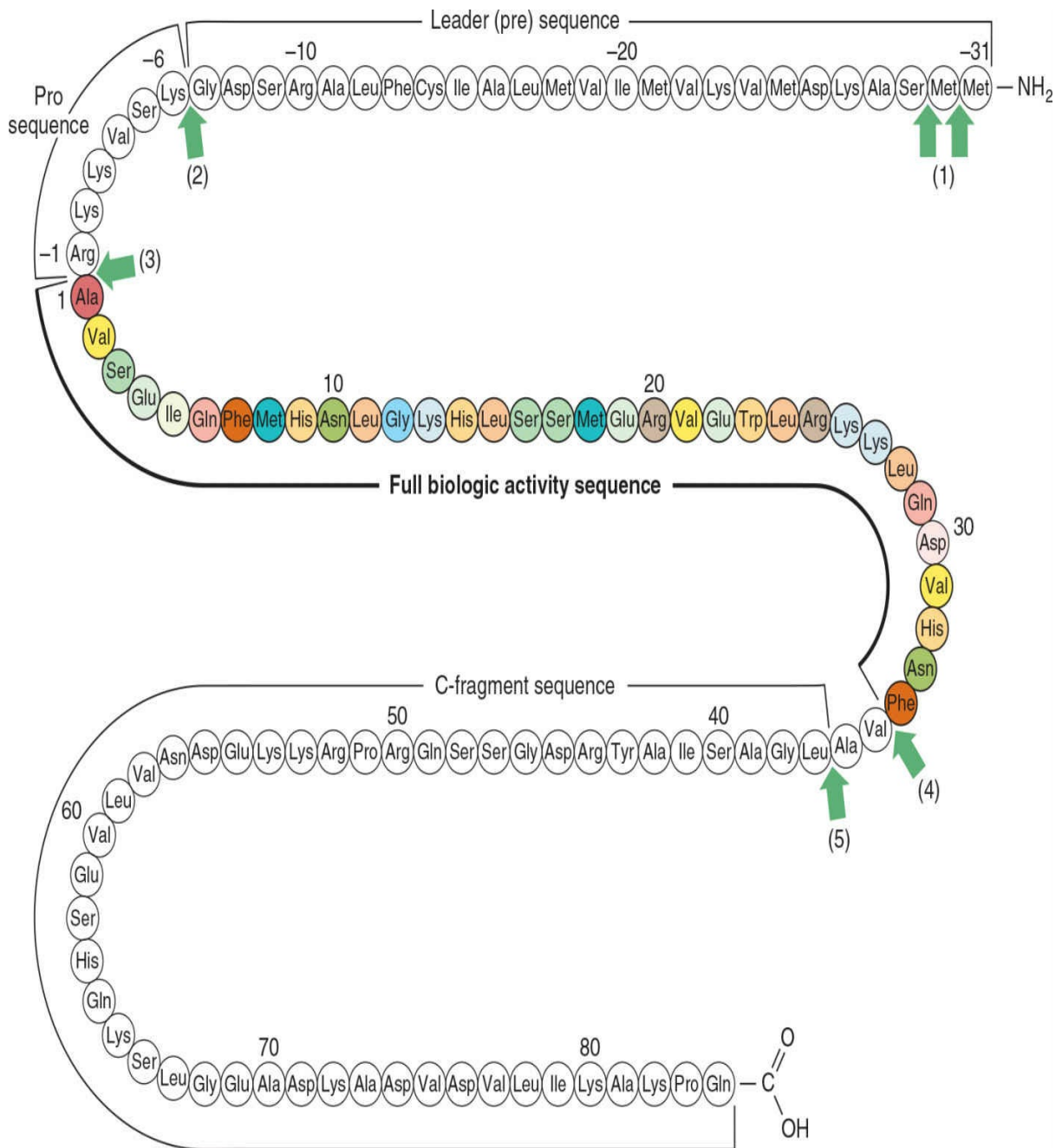

FIGURE 41–13 Structure of bovine preproparathyroid hormone. The green arrows indicate sites of cleavage by processing enzymes in the

parathyroid gland and in the liver after secretion of the hormone (numbered 1 to 5). The biologically active region of the molecule (colored) is flanked by sequence not required for activity on target receptors. (Slightly modified and reproduced, with permission, from Habener JF: Recent advances in parathyroid hormone research. Clin Biochem 1981;14:223. Copyright © 1981. Reprinted with permission from Elsevier.)

The biosynthesis of PTH and its subsequent secretion are regulated by the plasma ionized calcium (Ca^{2+}) concentration through a complex process. An acute decrease of Ca^{2+} results in a marked increase of PTH mRNA, and this is followed by an increased rate of PTH synthesis and secretion. However, about 80 to 90% of the proPTH synthesized cannot be accounted for as intact PTH in cells or in the incubation medium of experimental systems. This finding led to the conclusion that most of the proPTH synthesized is quickly degraded. It was later discovered that this rate of degradation decreases when Ca^{2+} concentrations are low, and it increases when Ca^{2+} concentrations are high. A Ca^{2+} receptor on the surface of the parathyroid cell mediates these effects. Very specific fragments of PTH are generated during its proteolytic digestion (Figure 41–13). A number of proteolytic enzymes, including cathepsins B and D, have been identified in parathyroid tissue. Cathepsin B cleaves PTH into two fragments: PTH_{1–36} and PTH_{37–84}. PTH_{37–84} is not further degraded; however, PTH_{1–36} is rapidly and progressively cleaved into di- and tripeptides. Most of the proteolysis of PTH occurs within the gland, but a number of studies confirm that PTH, once secreted, is proteolytically degraded in other tissues, especially the liver, by similar mechanisms.

Angiotensin II Is Also Synthesized From a Large Precursor

The renin-angiotensin system is involved in the regulation of blood pressure and electrolyte metabolism (through production of aldosterone). The primary hormone involved in these processes is angiotensin II, an octapeptide made from angiotensinogen (Figure 41–14). Angiotensinogen, a large α_2 -globulin made in liver, is the substrate for renin, an enzyme produced in the juxtaglomerular cells of the renal afferent arteriole. The position of these cells makes them particularly sensitive to blood pressure changes, and many of the physiologic regulators of renin release act

through renal baroreceptors. The juxtaglomerular cells are also sensitive to changes of Na^+ and Cl^- concentration in the renal tubular fluid; therefore, any combination of factors that decreases fluid volume (dehydration, decreased blood pressure, fluid, or blood loss) or decreases NaCl concentration stimulates renin release. Renal sympathetic nerves that terminate in the juxtaglomerular cells mediate the central nervous system and postural effects on renin release independently of the baroreceptor and salt effects, a mechanism that involves the β -adrenergic receptor. Renin acts on the substrate angiotensinogen to produce the decapeptide angiotensin I.

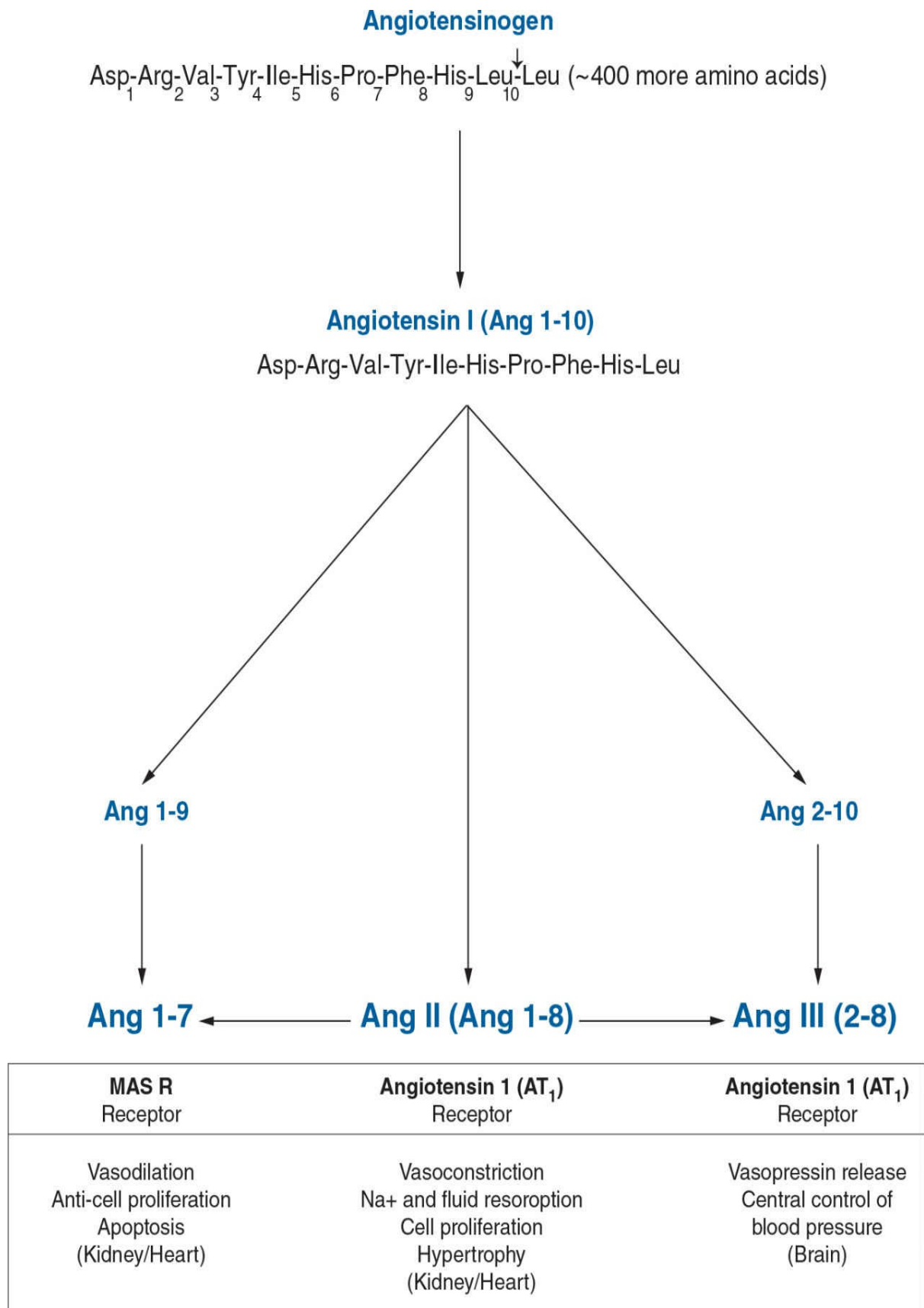

FIGURE 41–14 Formation, metabolism, and selected physiologic activities of angiotensins. The three most biologically active forms of

angiotensin (Ang), Ang 1-7, Ang 1-8 (Ang II), and Ang 2-8 (Ang III) are shown. The numbers represent the amino acids present in each Ang are numbered relative to the sequence of Ang 1-10 (Ang I). All Ang forms are derived by proteolysis catalyzed by a number of different proteases. Initial processing of the 400⁺ amino acid long angiotensinogen precursor is catalyzed by renin, while several of the other proteolytic events are catalyzed by angiotensin-converting enzyme 1 (ACE1), or ACE2. The receptors bound by the different Ang forms, as well as physiologic outcomes of receptor binding are shown (**bottom**).

Angiotensin-converting enzyme (ACE), a glycoprotein found in lung, endothelial cells, and plasma, removes two carboxyl terminal amino acids from the decapeptide angiotensin I to form angiotensin II in a step that is not thought to be rate-limiting. Various nonapeptide analogs of angiotensin I and other compounds act as competitive inhibitors of converting enzyme and are used to treat renin-dependent hypertension. These are referred to as ACE inhibitors. Angiotensin II increases blood pressure by causing vasoconstriction of the arteriole and is a very potent vasoactive substance. It inhibits renin release from the juxtaglomerular cells and is a potent stimulator of aldosterone production. This results in Na⁺ retention, volume expansion, and increased blood pressure.

In some species, angiotensin II is converted to the heptapeptide angiotensin III ([Figure 41–14](#)), an equally potent stimulator of aldosterone production. In humans, the plasma level of angiotensin II is four times greater than that of angiotensin III, so most effects are exerted by the octapeptide. Angiotensins II and III are rapidly inactivated by angiotensinases.

Angiotensin II binds to specific adrenal cortex glomerulosa cell receptors. The hormone-receptor interaction does not activate adenylyl cyclase, and cAMP does not appear to mediate the action of this hormone. The actions of angiotensin II, which are to stimulate the conversion of cholesterol to pregnenolone and of corticosterone to 18-hydroxycorticosterone and aldosterone, may involve changes in the concentration of intracellular calcium and of phospholipid metabolites by mechanisms similar to those described in [Chapter 42](#).

Complex Processing Generates the Pro-Opiomelanocortin Peptide Family

The POMC family consists of peptides that act as hormones (ACTH, LPH,

MSH) and others that may serve as neurotransmitters or neuromodulators (endorphins) (**Figure 41–15**). POMC is synthesized as a precursor molecule of 285 amino acids and is processed differently in various regions of the pituitary.

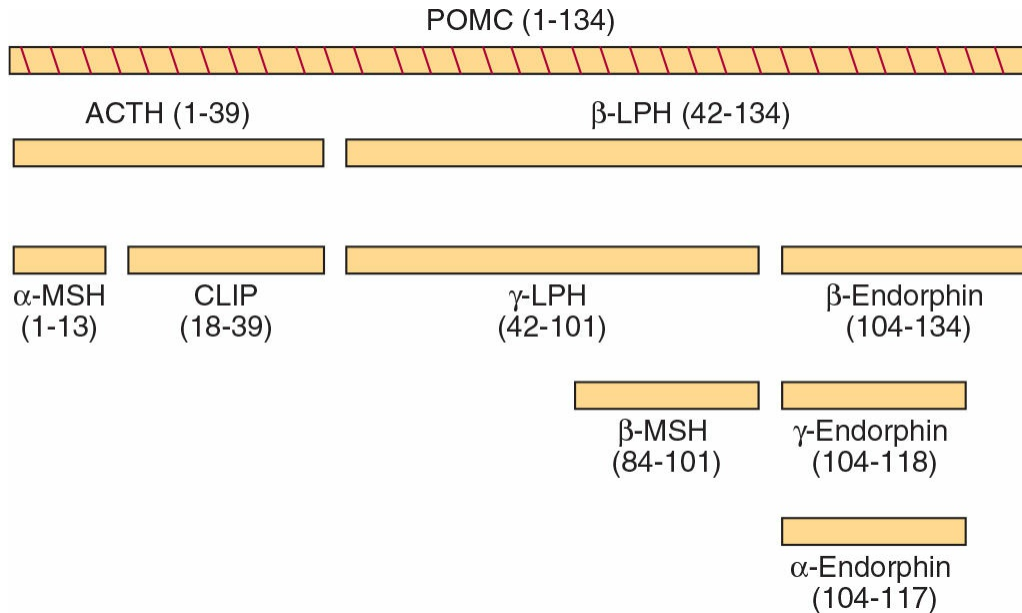

FIGURE 41–15 Products of pro-opiomelanocortin (POMC) cleavage. (CLIP, corticotropin-like intermediate lobe peptide; LPH, lipotropin; MSH, melanocyte-stimulating hormone.)

The POMC gene is expressed in the anterior and intermediate lobes of the pituitary. The most conserved sequences between species are within the amino terminal fragment, the ACTH region, and the β-endorphin region. POMC or related products are found in several other vertebrate tissues, including the brain, placenta, gastrointestinal tract, reproductive tract, lung, and lymphocytes.

The POMC protein is processed differently in the anterior lobe than in the intermediate lobe. The intermediate lobe of the pituitary is rudimentary in adult humans, but it is active in human fetuses and in pregnant women during late gestation and is also active in many animal species. Processing of the POMC protein in the peripheral tissues (gut, placenta, and male reproductive tract) resembles that in the intermediate lobe. There are three basic peptide groups: (1) ACTH, which can give rise to α-MSH and corticotropin-like intermediate lobe peptide (CLIP); (2) β-lipotropin (β-LPH), which can yield γ-LPH, β-MSH, and β-endorphin (and thus α- and γ-endorphins); and (3) a large amino-terminal peptide, which generates γ-MSH (not shown). The diversity of these products is due to the many

dibasic amino acid clusters that are potential cleavage sites for trypsin-like enzymes. Each of the peptides mentioned is preceded by Lys-Arg, Arg-Lys, Arg-Arg, or Lys-Lys residues. After the prehormone segment is cleaved, the next cleavage, in both anterior and intermediate lobes, is between ACTH and β -LPH, resulting in an amino-terminal peptide with ACTH and a β -LPH segment (Figure 41–15). ACTH_{1–39} is subsequently cleaved from the amino-terminal peptide, and in the anterior lobe essentially no further cleavages occur. In the intermediate lobe, ACTH_{1–39} is cleaved into α -MSH (residues 1-13) and CLIP (18-39); β -LPH (42-134) is converted to γ -LPH (42-101) and β -endorphin (104-134). β -MSH (84-101) is derived from γ -LPH, while γ -MSH (50-74) is derived from a POMC *N*-terminal fragment (1-74).

There are extensive additional tissue-specific modifications of these peptides that affect activity. These modifications include phosphorylation, acetylation, glycosylation, and amidation.

Mutations of the α -MSH receptor are linked to a common, early-onset form of obesity. This observation has redirected attention to the POMC peptide hormones.

THERE IS VARIATION IN THE STORAGE & SECRETION OF HORMONES

As mentioned above, the steroid hormones and 1,25(OH)₂-D₃ are synthesized in their final active form. They are also secreted as they are made, and thus there is no intracellular reservoir of these hormones. The catecholamines, also synthesized in active form, are stored in granules in the chromaffin cells in the adrenal medulla. In response to appropriate neural stimulation, these granules are released from the cell through exocytosis, and the catecholamines are released into the circulation. A several-hour reserve supply of catecholamines exists in the chromaffin cells.

PTH also exists in storage vesicles. As much as 80 to 90% of the proPTH synthesized is degraded before it enters this final storage compartment, especially when Ca²⁺ levels are high in the parathyroid cell (see above). PTH is secreted when Ca²⁺ is low in the parathyroid cells, which contain a several-hour supply of the hormone.

The human pancreas secretes about 40 to 50 units of insulin daily; this represents about 15 to 20% of the hormone stored in the β cells. Insulin and the C-peptide (Figure 41–12) are normally secreted in equimolar

amounts. Stimuli such as glucose, which provokes insulin secretion, therefore trigger the processing of proinsulin to insulin as an essential part of the secretory response.

A several-week supply of T_3 and T_4 exists in the thyroglobulin that is stored in colloid in the lumen of the thyroid follicles. These hormones can be released upon stimulation by TSH. This is the most exaggerated example of a prohormone, as a molecule containing ~5000 amino acids must be first synthesized, then degraded, to supply a few molecules of the active hormones T_4 and T_3 .

The diversity in storage and secretion of hormones is illustrated in **Table 41–5**.

TABLE 41–5 Diversity in the Storage of Hormones

Hormone	Supply Stored in Cell
Steroids and $1,25(\text{OH})_2\text{-D}_3$	None
Catecholamines and PTH	Hours
Insulin	Days
T_3 and T_4	Weeks

SOME HORMONES HAVE PLASMA TRANSPORT PROTEINS

The class I hormones are hydrophobic in chemical nature and thus are not very soluble in plasma. These hormones, principally the steroids and thyroid hormones, have specialized plasma transport proteins that serve several purposes. First, these proteins circumvent the solubility problem and thereby deliver the hormone to the target cell. They also provide a circulating reservoir of the hormone that can be substantial, as in the case of the thyroid hormones. Hormones, when bound to the transport proteins, cannot be metabolized, thereby prolonging their plasma half-life ($t_{1/2}$). The binding affinity of a given hormone to its transporter determines the bound versus free ratio of the hormone. This is important because only the free form of a hormone is biologically active. In general, the concentration of free hormone in plasma is very low, in the range of 10^{-15} to 10^{-9} mol/L. It is important to distinguish between plasma transport proteins and hormone

receptors. Both bind hormones but with very different characteristics (**Table 41–6**).

TABLE 41–6 Comparison of Receptors With Transport Proteins

Feature	Receptors	Transport Proteins
Concentration	Very low (thousands/cell)	Very high (billions/ μL)
Binding affinity (K_d)	High (pmol/L to nmol/L range)	Low ($\mu\text{mol/L}$ range)
Binding specificity	Very high	Low
Saturability	Yes	No
Reversibility	Yes	Yes
Signal transduction	Yes	No

The hydrophilic hormones—generally class II and of peptide structure—are freely soluble in plasma and do not require transport proteins. Hormones such as insulin, growth hormone, ACTH, and TSH circulate in the free, active form and have very short plasma half-lives. A notable exception is IGF-I, which is transported bound to members of a family of binding proteins.

Thyroid Hormones Are Transported by Thyroid-Binding Globulin

Many of the principles discussed above are illustrated in a discussion of thyroid-binding proteins. One-half to two-thirds of T_4 and T_3 in the body is in an extrathyroidal reservoir. Most of this circulates in bound form, that is, bound to a specific binding protein, **thyroxine-binding globulin (TBG)**. TBG, a glycoprotein with a molecular mass of 50 kDa, binds T_4 and T_3 and has the capacity to bind 20 $\mu\text{g/dL}$ of plasma. Under normal circumstances, TBG binds—noncovalently—nearly all of the T_4 and T_3 in plasma, and it binds T_4 with greater affinity than T_3 (**Table 41–7**). The plasma half-life of T_4 is correspondingly four to five times that of T_3 . The small, unbound (free) fraction is responsible for the biologic activity. Thus, in spite of the great difference in total amount, the free fraction of T_3

approximates that of T₄, and given that T₃ is intrinsically more active than T₄, most biologic activity is attributed to T₃. TBG does not bind any other hormones.

TABLE 41–7 Comparison of T₄ and T₃ in Plasma

Total Hormone (µg/dL)	Free Hormone				t _{1/2} in Blood (days)
	Percentage of Total	ng/dL	Molarity		
T ₄	8	0.03	~2.24	3.0 × 10 ⁻¹¹	6.5
T ₃	0.15	0.3	~0.4	0.6 × 10 ⁻¹¹	1.5

Glucocorticoids Are Transported by Corticosteroid-Binding Globulin

Hydrocortisone (cortisol) also circulates in plasma in protein-bound and free forms. The main plasma binding protein is an α-globulin called **transcortin**, or **corticosteroid-binding globulin (CBG)**. CBG is produced in the liver, and its synthesis, like that of TBG, is increased by estrogens. CBG binds most of the hormone when plasma cortisol levels are within the normal range; much smaller amounts of cortisol are bound to albumin. The affinity of binding helps determine the biologic half-lives of various glucocorticoids. Cortisol binds tightly to CBG and has a t_{1/2} of 1.5 to 2 hours, while corticosterone, which binds less tightly, has a t_{1/2} of <1 hour (**Table 41–8**). The unbound (free) cortisol constitutes ~8% of the total and represents the biologically active fraction. Binding to CBG is not restricted to glucocorticoids. Deoxycorticosterone and progesterone interact with CBG with sufficient affinity to compete for cortisol binding. Aldosterone, the most potent natural mineralocorticoid, does not have a specific plasma transport protein. Gonadal steroids bind very weakly to CBG (**Table 41–8**).

TABLE 41–8 Approximate Affinities of Steroids for Serum-Binding Proteins

	SHBG ^a	CBG ^a
Dihydrotestosterone	1	>100
Testosterone	2	>100
Estradiol	5	>10
Estrone	>10	>100
Progesterone	>100	~2
Cortisol	>100	~3
Corticosterone	>100	~5

^aAffinity expressed as K_d (nmol/L).

Abbreviations: CBG, corticosteroid-binding globulin; SHBG, sex hormone-binding globulin.

Gonadal Steroids Are Transported by Sex Hormone–Binding Globulin

Most mammals, humans included, have a plasma β -globulin that binds testosterone with specificity, relatively high affinity, and limited capacity (Table 41–8). This protein, usually called **sex hormone-binding globulin (SHBG)** or testosterone-estrogen-binding globulin (TEBG), is produced in the liver. Its production is increased by estrogens (women have twice the serum concentration of SHBG as men), certain types of liver disease, and hyperthyroidism; it is decreased by androgens, advancing age, and hypothyroidism. Many of these conditions also affect the production of CBG and TBG. Since SHBG and albumin bind 97 to 99% of circulating testosterone, only a small fraction of the hormone in circulation is in the free (biologically active) form. The primary function of SHBG may be to restrict the free concentration of testosterone in the serum. Testosterone binds to SHBG with higher affinity than does estradiol (Table 41–8). Therefore, a change in the level of SHBG causes a greater change in the free testosterone level than in the free estradiol level.

Estrogens are bound to SHBG and progestins to CBG. SHBG binds estradiol about five times less avidly than it binds testosterone or DHT, while progesterone and cortisol have little affinity for this protein (Table 41–8). In contrast, progesterone and cortisol bind with nearly equal affinity to CBG, which in turn has little affinity for estradiol and even less for testosterone, DHT, or estrone.

These binding proteins also provide a circulating reservoir of hormone, and because of the relatively large binding capacity, they probably buffer against sudden changes in the plasma level. Because the metabolic clearance rates of these steroids are inversely related to the affinity of their binding to SHBG, estrone is cleared more rapidly than estradiol, which in turn is cleared more rapidly than testosterone or DHT.

SUMMARY

- The presence of a specific receptor defines the target cells for a given hormone.
- Receptors are proteins that bind specific hormones and generate an intracellular signal (receptor-effector coupling).
- Some hormones have intracellular receptors; others bind to receptors on the plasma membrane.
- Hormones are synthesized from a number of precursor molecules, including cholesterol, tyrosine per se, and all the constituent amino acids of peptides and proteins.
- A number of modification processes alter the activity of hormones. For example, many hormones are synthesized from larger precursor molecules.
- The complement of enzymes in a particular cell type allows for the production of a specific class of steroid hormone.
- Most of the lipid-soluble hormones are bound to rather specific plasma transport proteins.

REFERENCES

- Bain DL, Heneghan AF, Connaghan-Jones KD, Miura MT: Nuclear receptor structure: implications for function. *Annu Rev Physiol* 2007;69:201-220.
- Bartalina L: Thyroid hormone-binding proteins: update 1994. *Endocr Rev* 1994;13:140-142.
- Cristina Casals-Casas C, Desvergne B: Endocrine disruptors: from endocrine to metabolic disruption. *Annu Rev Physiol* 2011;73:135-162.
- DeLuca HR: The vitamin D story: a collaborative effort of basic science and clinical medicine. *FASEB J* 1988;2:224-236.
- Douglass J, Civelli O, Herbert E: Polyprotein gene expression: generation of diversity of neuroendocrine peptides. *Annu Rev Biochem* 1984;53:665-715.

- Farooqi IS, O'Rahilly S: Monogenic obesity in humans. *Annu Rev Med* 2005;56:443-458.
- Fan W, Atkins AR, Yu RT, et al: Road to exercise mimetics: targeting nuclear receptor in skeletal muscle. *J Mol Endocrinol* 2013;51:T87-T100.
- Hah N, Kraus WL: Hormone-regulated transcriptomes: lessons learned from estrogen signaling pathways in breast cancer cells. *Mol Cell Endocrinol* 2014;382:652-664.
- Miller WL: Molecular biology of steroid hormone biosynthesis. *Endocr Rev* 1988;9:295-318.
- Russell DW, Wilson JD: Steroid 5 alpha-reductase: two genes/two enzymes. *Annu Rev Biochem* 1994;63:25-61.
- Steiner DF, Smeekens SP, Ohagi S, et al: The new enzymology of precursor processing endoproteases. *J Biol Chem* 1992;267:23435-23438.
- Taguchi A, White M: Insulin-like signaling, nutrient homeostasis, and life span. *Annu Rev Physiol* 2008;70:191-212.
- Weikum ER, Knuesel MT, Ortlund EA, Yamamoto KR: Glucocorticoid receptor control of transcription: precision and plasticity via allostery. *Nat Rev Mol Cell Biol* 2017;18:159-174.
- Xu Y, O'Malley BW, Elmquist JK: Brain nuclear receptors and body weight regulation. *J Clin Invest* 2017;127:1172-1180.

Hormone Action & Signal Transduction

P. Anthony Weil, PhD

OBJECTIVES

After studying this chapter, you should be able to:

- Explain the roles of stimulus, hormone release, signal generation, and effector response in hormone-regulated physiologic processes.
- Describe the role of receptors and guanosine nucleotide-binding G-proteins in hormone signal transduction, particularly with regard to the generation of second messengers.
- Appreciate the complex patterns of signal transduction pathway cross-talk in mediating complicated physiologic outputs.
- Understand the key roles that protein-ligand, protein–protein, protein posttranslational modification, and protein-DNA interactions play in mediating hormone-directed physiologic processes.
- Detail why hormone-modulated receptors, second messengers, and associated signaling molecules represent a rich source of potential drug target development given their key roles in the regulation of physiology.

BIOMEDICAL IMPORTANCE

The homeostatic adaptations an organism makes to a constantly changing environment are in large part accomplished through alterations of the activity and amount of proteins. Hormones provide a major means of facilitating these changes. A hormone-receptor interaction results in generation of an amplified intracellular signal that can either regulate the activity of a select set of genes that alters the amounts of certain proteins in the target cell or affect the activity of specific proteins, including enzymes, transporters, or channel proteins. Signals can influence the location of proteins in the cell, and often affects general processes such as protein synthesis, cell growth, and replication, via their effects on gene expression. Other signaling molecules—including cytokines, interleukins, growth factors, and metabolites—use some of the same general mechanisms and signal transduction pathways. Excessive, deficient, or inappropriate production and release of hormones and the other regulatory signaling molecules are major causes of disease. Many pharmacotherapeutic agents are aimed at correcting or otherwise influencing the pathways discussed in this chapter.

HORMONES TRANSDUCE SIGNALS TO AFFECT HOMEOSTATIC MECHANISMS

The general steps involved in producing a coordinated response to a particular stimulus are illustrated in [Figure 42–1](#). The stimulus can be a challenge or a threat to the organism, to an organ, or to the integrity of a single cell within that organism. Recognition of the stimulus is the first step in the adaptive response. At the organismic level, this generally involves the nervous system and the special senses (sight, hearing, pain, smell, and touch). At the organ, tissue, or cellular level, recognition involves physicochemical factors such as pH, O₂ tension, temperature, nutrient supply, noxious metabolites, and osmolarity. Appropriate recognition results in the release of one or more hormones that will govern generation of the necessary adaptive response. For purposes of this discussion, the hormones are categorized as described in [Table 41–4](#), that is, based on the location of their specific cellular receptors and the type of signals generated. Group I hormones interact with an intracellular receptor and group II hormones with receptor recognition sites located on the

extracellular surface of the plasma membrane of target cells. The cytokines, interleukins, and growth factors should also be considered in this latter category. These molecules, of critical importance in homeostatic adaptation, are hormones in the sense that they are produced in specific cells, have the equivalent of autocrine, paracrine, and endocrine actions, bind to cell surface receptors, and activate many of the same signal transduction pathways employed by the more traditional group II hormones.

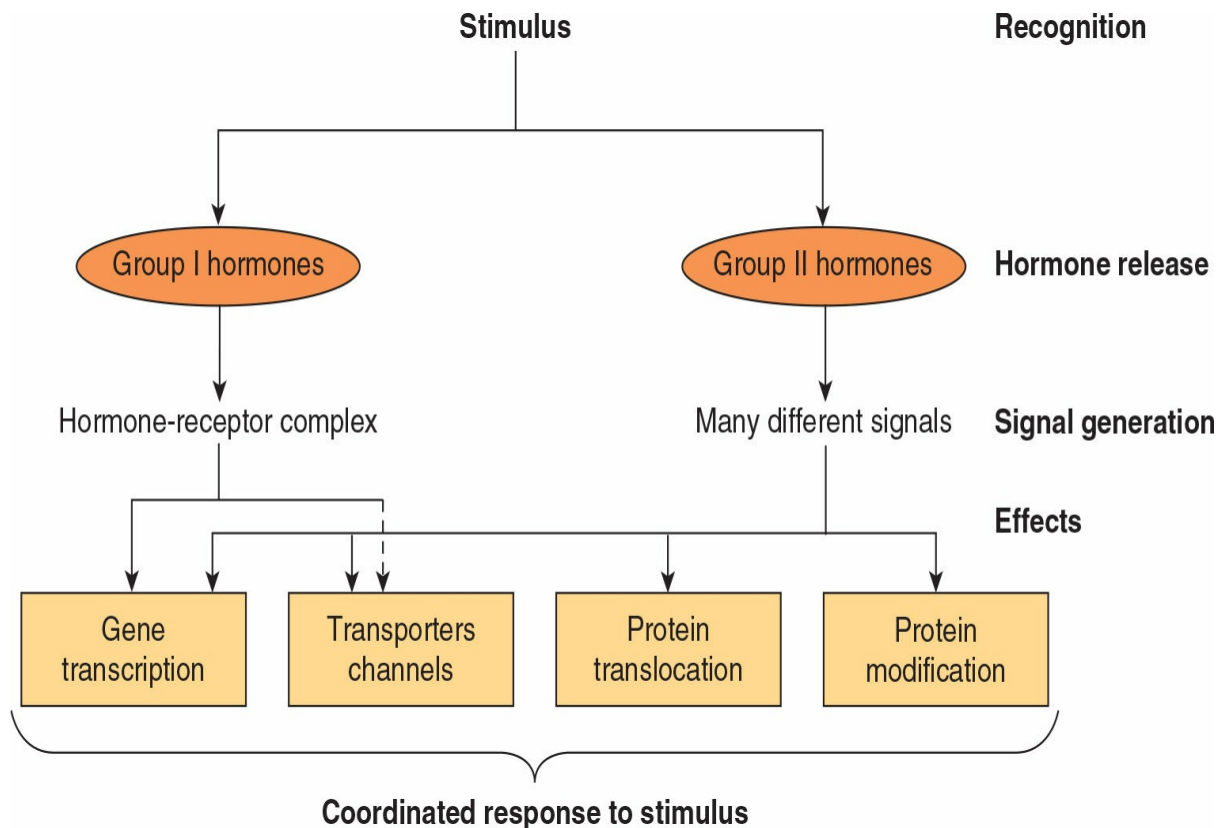

FIGURE 42–1 Hormonal involvement in responses to a stimulus. Physiologic needs, or challenges to the integrity of the organism, elicit a response that includes the release of one or more hormones. These hormones generate signals at or within target cells and these signals regulate a variety of biologic processes that provide for a coordinated response to the stimulus or challenge. See [Figure 42–8](#) for a specific example.

SIGNAL GENERATION

The Ligand-Receptor Complex Is the Signal for Group I Hormones

The lipophilic group I hormones diffuse through the plasma membrane of all cells but only encounter their specific, high-affinity intracellular receptors in target cells. These receptors can be located in the cytoplasm or in the nucleus of target cells. The hormone-receptor complex first undergoes an **activation reaction**. As shown in [Figure 42–2](#), receptor activation occurs by at least two mechanisms. For example, glucocorticoids diffuse across the plasma membrane and encounter their cognate receptor in the cytoplasm of target cells. Ligand-receptor binding results in a conformational change in the receptor leading to the dissociation of heat shock protein 90 (hsp90). This step is necessary for subsequent nuclear localization of the glucocorticoid receptor (GR). This receptor also contains a nuclear localization sequence that is now free to assist in the translocation from cytoplasm to nucleus. The activated receptor moves into the nucleus ([Figure 42–2](#)) and binds with high affinity to a specific DNA sequence called the **hormone response element (HRE)**. In the case of GR, this is a glucocorticoid response element, or GRE. Consensus sequences for HREs are shown in [Table 42–1](#). The DNA-bound, liganded receptor serves as a high-affinity binding target for one or more coactivator proteins, and accelerated gene transcription typically ensues when this occurs. By contrast, certain hormones such as the thyroid hormones and retinoids diffuse from the extracellular fluid across the plasma membrane and go directly into the nucleus. In this case, the cognate receptor is already bound to the HRE (the thyroid hormone response element [TRE], in this example). However, this DNA-bound receptor fails to activate transcription because it exists in complex with a corepressor. Indeed, this receptor-corepressor complex serves as a tonic repressor of gene transcription. Association of ligand with these receptors results in dissociation of the corepressor(s). The liganded receptor is now capable of binding one or more coactivators with high affinity, resulting in the recruitment of RNA polymerase II and the GTFs and activation of gene transcription as noted above for the GR-GRE complex. The relationship of hormone receptors to other nuclear receptors and to coregulators is discussed in more detail below.

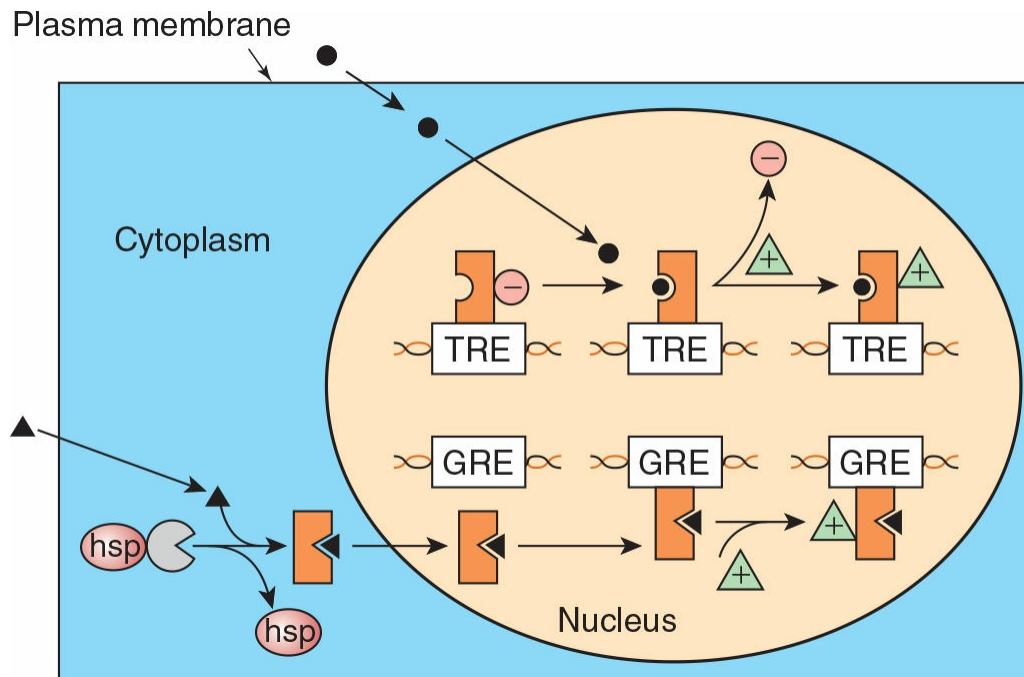





FIGURE 42–2 Regulation of gene expression by two different group I hormones, thyroid hormone and glucocorticoids. The hydrophobic steroid hormones readily gain access to the cytoplasmic compartment of target cells by diffusion through the plasma membrane. Glucocorticoid hormones (solid triangles) encounter their cognate receptor (GR) in the cytoplasm where GR exists in a complex with a chaperone protein, heat shock protein 90 (hsp). Ligand binding causes dissociation of hsp90 and a conformational change of the receptor. The receptor-ligand complex then traverses the nuclear membrane and binds to DNA with specificity and high affinity at a glucocorticoid response element (GRE). This event affects the architecture of a number of transcription coregulators (green triangles), and enhanced transcription ensues. By contrast, thyroid hormones and retinoic acid (black circle) directly enter the nucleus, where their cognate heterodimeric (TR-RXR; see [Figure 42–12](#)) receptors are already bound to the appropriate response elements with an associated transcription corepressor complex (red circles). Binding of hormones occurs, which again induces conformational changes in the receptor leading to dissociation of the corepressor complex from the receptor, thereby allowing an activator complex, consisting of the TR-TRE and coactivator, to assemble. The gene is then actively transcribed.

TABLE 42–1 The DNA Sequences of Several Hormone Response Elements (HREs)^a

Hormone or Effector	HRE	DNA Sequence
Glucocorticoids	GRE	GGTACA _{NNN} TGTTCT 
Progestins	PRE	
Mineralocorticoids	MRE	
Androgens	ARE	
Estrogens	ERE	AGGTCA — TGACCT 
Thyroid hormone	TRE	AGGTCA _{N₍₁₋₅₎} AGGTCA 
Retinoic acid	RARE	
Vitamin D	VDRE	
cAMP	CRE	TGACGTCA

^aLetters indicate nucleotide; N means any one of the four can be used in that position. The arrows pointing in opposite directions illustrate the slightly imperfect inverted palindromes present in many HREs; in some cases, these are called “half binding sites,” or half-sites, because each binds one monomer of the receptor. The GRE, PRE, MRE, and ARE consist of the same DNA sequence. Specificity may be conferred by the intracellular concentration of the ligand or hormone receptor, by flanking DNA sequences not included in the consensus, or by other accessory elements. A second group of HREs includes those for thyroid hormones, estrogens, retinoic acid, and vitamin D. These HREs are similar except for the orientation and spacing between the half palindromes. Spacing determines the hormone specificity. VDRE ($N = 3$), TRE ($N = 4$), and RARE ($N = 5$) bind to direct repeats rather than to inverted repeats. Another member of the steroid receptor superfamily, the retinoid X receptor (RXR), forms heterodimers with VDR, TR, and RARE, and these constitute the functional forms of these DNA-binding transacting factors. cAMP affects gene transcription through the CRE.

By selectively affecting gene transcription and the consequent production of appropriate target mRNAs, the amounts of specific proteins are changed and metabolic processes are influenced. The influence of each of these hormones is quite specific; generally, a given hormone directly affects <1% of the genes, mRNA, or proteins in a target cell; sometimes only a few are affected. The nuclear actions of steroid, thyroid, and retinoid hormones are quite well defined. Most evidence suggests that these hormones exert their dominant effect on modulating gene transcription, but they—and many of the hormones in the other classes

discussed below—can act at any step of the “information pathway,” as illustrated in **Figure 42–3**, to control specific gene expression and, ultimately, a biologic response. Direct actions of steroids in the cytoplasm and on various organelles and membranes have also been described. Recently, microRNAs and lncRNAs have been implicated in mediating some of the diverse actions of hormones.

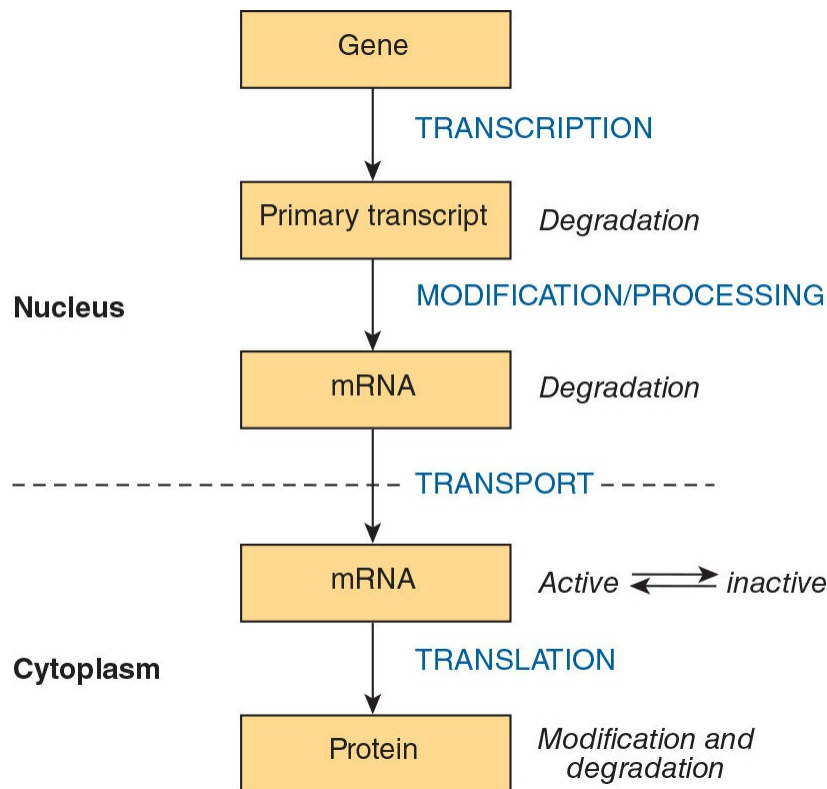

FIGURE 42–3 The “information pathway.” Information flows from the gene to the primary transcript to mRNA to protein. Hormones can affect any of the steps involved and can affect the rates of processing, degradation, or modification of the various products.

GROUP II (PEPTIDE & CATECHOLAMINE) HORMONES HAVE MEMBRANE RECEPTORS & USE INTRACELLULAR MESSENGERS

Many hormones are water soluble, have no transport proteins (and therefore have a short plasma half-life), and initiate a response by binding to a receptor located in the plasma membrane (see **Tables 41–3** and **41–4**). The mechanism of action of this group of hormones can best be discussed in terms of the **intracellular signals** they generate. These signals include **cAMP** (cyclic AMP; 3',5'-adenylic acid; see **Figure 18–5**), a nucleotide

derived from ATP through the action of adenylyl cyclase; **cGMP**, a nucleotide formed from GTP by guanylyl cyclase; **Ca²⁺**; and **phosphatidylinositides**; such small molecules are **termed second messengers** as their synthesis is triggered by the presence of the primary hormone (molecule) binding its receptor. Many of these second messengers affect gene transcription, as described in the previous paragraph; but they also influence a variety of other biologic processes, as shown in [Figure 42–3](#), but see also [Figures 42–6](#) and [42–8](#).

G-Protein–Coupled Receptors

Many of the group II hormones bind to receptors that couple to effectors through a **guanine-binding protein (G-proteins)** intermediary. These receptors typically have seven α -helical hydrophobic plasma membrane-spanning domains, here illustrated by the seven interconnected cylinders extending through the lipid bilayer in [Figure 42–4](#). Receptors of this class, which signal through G-proteins, are known as **G-protein–coupled receptors (GPCRs)**. To date, hundreds of *GPCR* genes have been identified, and represent the largest family of cell surface receptors in humans. Not surprisingly, a wide variety of responses are mediated by the GPCRs.

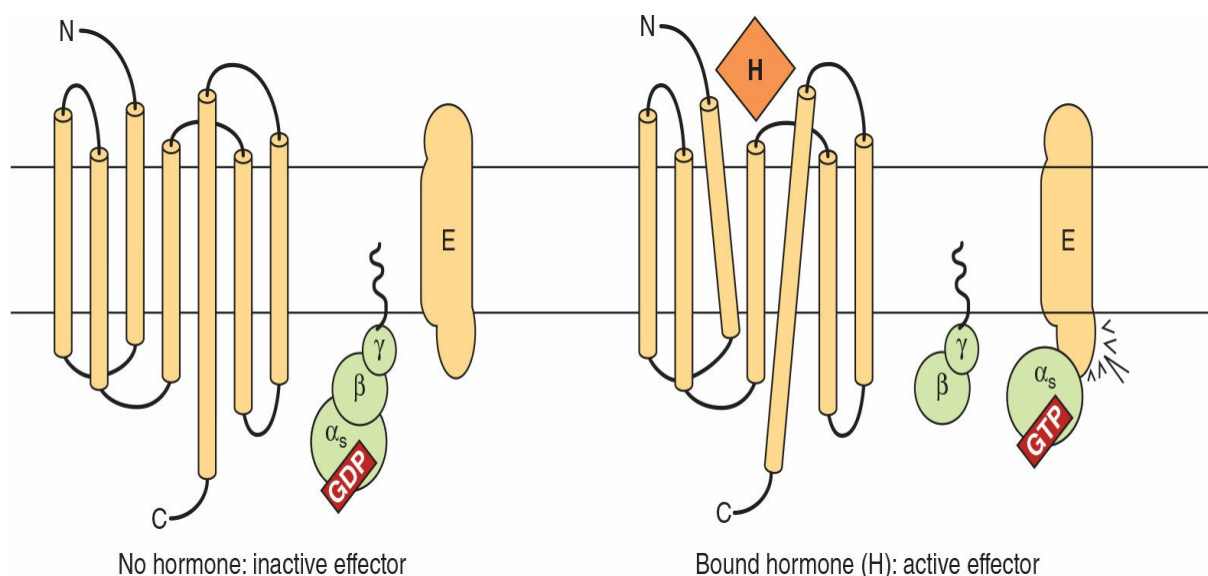

FIGURE 42–4 Components of the hormone receptor–G-protein effector system. Receptors that couple to effectors through G-proteins, the G-protein–coupled receptors (GPCRs), typically have seven α -helical membrane-spanning domains (here shown as long cylinders). In the absence of hormone (**left**), the heterotrimeric G-protein complex (α, β, γ) is

in an inactive guanosine diphosphate (GDP)-bound form and is probably not associated with the receptor. This complex is anchored to the plasma membrane through prenylated groups on the $\beta\gamma$ subunits (**wavy lines**) and perhaps by myristoylated groups on α subunits (not shown). On binding of hormone (H) to the receptor, there are conformational changes within the receptor (as indicated by the tilted membrane-spanning domains) and association of the G-protein complex with the rearranged receptor—this activates the G-protein complex. This activation results from the exchange of GDP with guanosine triphosphate (GTP) on the α subunit, after which α and $\beta\gamma$ dissociate. The α subunit binds to and activates the effector (E). E can be adenylyl cyclase, Ca^{2+} , Na^+ , or Cl^- channels (α_s), or it could be a K^+ channel (α_i), phospholipase $\text{C}\beta$ (α_q), or cGMP phosphodiesterase (α_t); see [Table 42–3](#). The $\beta\gamma$ subunit can also have direct actions on E. (Modified and reproduced, with permission, from Granner DK. In: *Principles and Practice of Endocrinology and Metabolism*, 2nd ed. Becker KL (editor). Lippincott, 1995.)

cAMP Is the Intracellular Signal for Many Responses

Cyclic AMP was the first intracellular second messenger signal identified in mammalian cells. Several components comprise a system for the generation, degradation, and action of cAMP ([Table 42–2](#)).

TABLE 42–2 Subclassification of Group II.A Hormones

Hormones That Stimulate Adenylyl Cyclase (H_s)	Hormones That Inhibit Adenylyl Cyclase (H_i)
ACTH	Acetylcholine
ADH	α_2 -Adrenergics
β -Adrenergics	Angiotensin II
Calcitonin	Somatostatin
CRH	
FSH	
Glucagon	
hCG	
LH	
LPH	
MSH	
PTH	
TSH	

Abbreviations: ACTH, adrenocorticotropic hormone; ADH, antidiuretic hormone; CRH, corticotropin-releasing hormone; FSH, follicle-stimulating hormone; hCG, human chorionic gonadotropin; LH, luteinizing hormone; LPH, lipotropin; MSH, melanocyte-stimulating hormone; PTH, parathyroid hormone; TSH, thyroid-stimulating hormone.

Adenylyl Cyclase

Different peptide hormones can either stimulate (s) or inhibit (i) the production of cAMP from adenylyl cyclase through the action of the G-proteins. G-proteins are encoded by at least 10 different genes (**Table 42–3**). Two parallel systems, a stimulatory (s) one and an inhibitory (i) one, converge upon a catalytic molecule (C). Each consists of a receptor, R_s or R_i , and a regulatory G-protein complex termed G_s and G_i . Both G_s and G_i are **heterotrimeric G-proteins composed of α , β , and γ subunits**. Since the α subunit in G_s differs from that in G_i , the proteins, which are distinct gene products, are designated α_s and α_i . The α subunits bind guanine nucleotides. The β and γ subunits are likely always associated ($\beta\gamma$) and appear to function predominantly as a heterodimer. The binding of a

hormone to R_s or R_i results in a receptor-mediated activation of G-protein, which entails the exchange of GDP by GTP on α and the concomitant dissociation of $\beta\gamma$ from α .

TABLE 42–3 Classes and Functions of Selected G-Proteins^a

Class or Type	Stimulus	Effector	Effect
G_s			
α_s	Glucagon, β -adrenergics	\uparrow Adenylyl cyclase \uparrow Cardiac Ca^{2+} , Cl^- , and Na^+ channels	Glyconeogenesis, lipolysis, glycogenolysis Olfaction
α_{olf}	Odorant	\uparrow Adenylyl cyclase	
G_i			
$\alpha_{i-1,2,3}$	Acetylcholine, α_2 -adrenergics	\downarrow Adenylyl cyclase \uparrow Potassium channels	Slowed heart rate
	M_2 cholinergics	\downarrow Calcium channels	
α_o	Opioids, endorphins	\uparrow Potassium channels	Neuronal electrical activity
α_t	Light	\uparrow cGMP phosphodiesterase	Vision
G_q			
α_q	M_1 cholinergics α_1 -Adrenergics	\uparrow Phospholipase C- $\beta 1$	\downarrow Muscle contraction
α_{11}	α_1 -Adrenergics	\uparrow Phospholipase C- $\beta 2$	\downarrow Blood pressure
G_{12}			
α_{12}	Thrombin	Rho	Cell shape changes

^aThe four major classes or families of mammalian G-proteins (G_s , G_i , G_q , and G_{12}) are based on protein sequence conservation. Representative members of each are shown, along with known stimuli, effectors, and well-defined biologic effects. Nine isoforms of adenylyl cyclase have been identified (isoforms I-IX). All isoforms are stimulated by α_s ; α_i isoforms inhibit types V and VI, and α_o inhibits types I and V. At least 16 different α subunits have been identified.

Source: Modified and reproduced, with permission, from Granner DK: In: *Principles and Practice of Endocrinology and Metabolism*, 2nd ed. Becker KL (editor). Lippincott, 1995.

The α_s protein has intrinsic GTPase activity. The active form, α_s -GTP, is inactivated on hydrolysis of the GTP to GDP; the **trimeric G_s complex ($\alpha\beta\gamma$)** is then reformed and is ready for another cycle of activation. **Cholera** and **pertussis toxins** catalyze the **ADP ribosylation** of α_s and α_{i-2} (Table 42–3), respectively. In the case of α_s , this modification disrupts the intrinsic GTPase activity; thus, α_s cannot reassociate with $\beta\gamma$ and is therefore irreversibly activated. ADP ribosylation of α_{i-2} prevents the

dissociation of α_{i-2} from $\beta\gamma$, and free α_{i-2} thus cannot be formed. α_s activity in such cells is therefore unopposed.

There is a large family of G-proteins, and these are part of the superfamily of GTPases. The G-protein family is classified according to sequence homology into four subfamilies, as illustrated in [Table 42–3](#). There are 21 α , 5 β , and 8 γ subunit genes. Various combinations of these subunits provide a large number of possible $\alpha\beta\gamma$ complexes.

The α subunits and the $\beta\gamma$ complex have actions independent of those on adenylyl cyclase (see [Figure 42–4](#) and [Table 42–3](#)). Some forms of α_i stimulate K^+ channels and inhibit Ca^{2+} channels, and some α_s molecules have the opposite effects. Members of the G_q family activate the phospholipase C group of enzymes. The $\beta\gamma$ complexes have been associated with K^+ channel stimulation and phospholipase C activation. G proteins are involved in many important biologic processes in addition to hormone action. Notable examples include olfaction (α_{OLF}) and vision (α_t). Some examples are listed in [Table 42–3](#). GPCRs are implicated in a number of diseases and are major targets for pharmaceutical agents.

Protein Kinase

As discussed in [Chapter 38](#), in prokaryotic cells, cAMP binds to a specific protein called cAMP activator protein (CAP) that binds directly to DNA and influences gene expression. By contrast, in eukaryotic cells, cAMP binds to a protein kinase called **protein kinase A (PKA)**, a heterotetrameric molecule consisting of two regulatory subunits (R) that inhibit the activity of the two catalytic subunits (C) when bound as a tetrameric complex. cAMP binding to the R_2C_2 tetramer results in the following reaction:

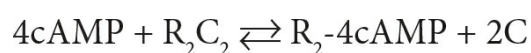

The R_2C_2 complex has no enzymatic activity, but the binding of cAMP to the R subunit induces dissociation of the R-C complex, thereby activating the latter ([Figure 42–5](#)). The active C subunit catalyzes the transfer of the γ phosphate of ATP to a serine or threonine residue in a variety of proteins. The consensus PKA phosphorylation sites are -ArgArg/Lys-X-Ser/Thr- and -Arg-Lys-X-X-Ser-, where X can be any amino acid.

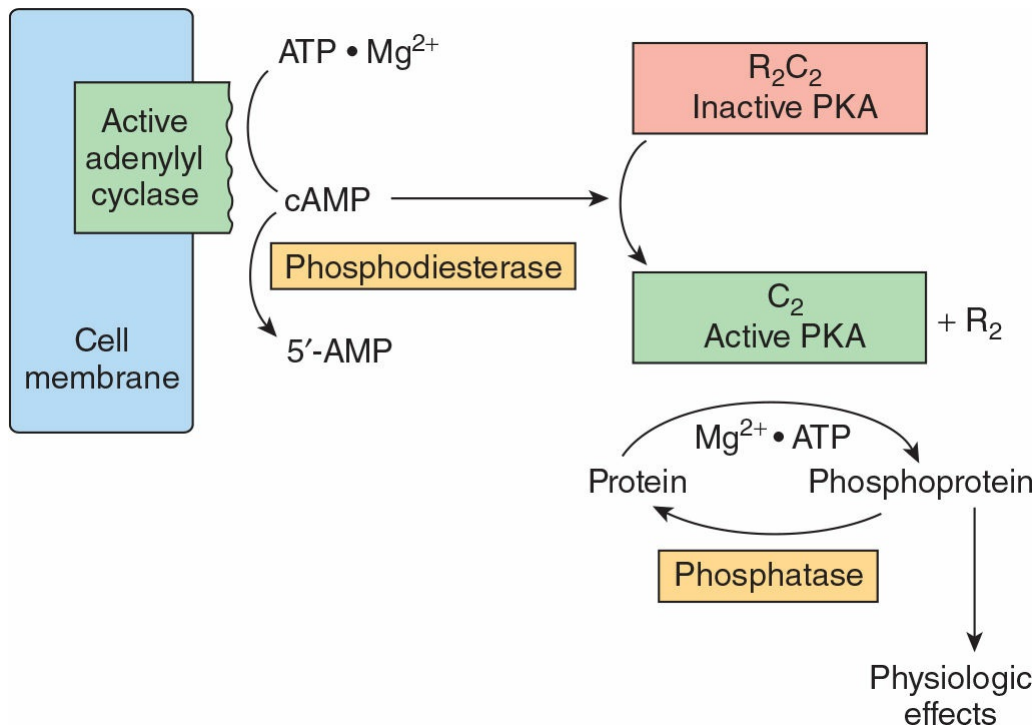

FIGURE 42–5 Hormonal regulation of cellular processes through cAMP-dependent protein kinase (PKA). PKA exists in an inactive form as an R_2C_2 heterotetramer consisting of two regulatory (R) and two catalytic (C) subunits. The cAMP generated by the action of adenylyl cyclase (activated as shown in Figure 42–4) binds to the regulatory subunit of PKA. This results in dissociation of the regulatory and catalytic subunits and activation of the latter. The active catalytic subunits phosphorylate a number of target proteins on serine and threonine residues. Phosphatases remove phosphate from these residues and thus terminate the physiologic response. A phosphodiesterase can also terminate the response by converting cAMP to 5'-AMP.

Historically protein kinase activities were described as being “cAMP-dependent” or “cAMP-independent.” This classification has changed, as protein phosphorylation is now recognized as being a major and ubiquitous regulatory mechanism. Several hundred protein kinases have now been described. These kinases are related in sequence and structure within the catalytic domain, but each is a unique molecule with considerable variability with respect to subunit composition, molecular weight, autophosphorylation, K_m for ATP, and substrate specificity. Both kinase and protein phosphatase activities can be targeted by interaction with specific kinase-binding proteins. In the case of PKA, such targeting proteins are termed A kinase anchoring proteins, or **AKAPs**. AKAPs serve

as scaffolds, which localize PKA near to substrates thereby focusing PKA activity toward physiologic substrates and facilitating spatiotemporal biologic regulation while also allowing for common, shared proteins to elicit specific physiologic responses. Multiple AKAPs have been described and importantly they can bind PKA and other kinases as well as phosphatases, phosphodiesterases (which hydrolyze cAMP), and protein kinase substrates. The multifunctionality of AKAPs facilitates signaling localization, rate (production and destruction of signals), specificity, and dynamics.

Phosphoproteins

The effects of cAMP in eukaryotic cells are all thought to be mediated by protein phosphorylation-dephosphorylation, principally on serine and threonine residues. The control of any of the effects of cAMP, including such diverse processes as steroidogenesis, secretion, ion transport, carbohydrate and fat metabolism, enzyme induction, gene regulation, synaptic transmission, and cell growth and replication, could be conferred by a specific protein kinase, by a specific phosphatase, or by specific substrates for phosphorylation. The array of specific substrates contributes critically to defining a target tissue, and are involved in defining the extent of a particular response within a given cell. For example, the effects of cAMP on gene transcription are mediated by the cyclic AMP response element binding protein (**CREB**). When CREB binds to a cAMP responsive DNA enhancer element (**CRE**) (see [Table 42–1](#)) in its nonphosphorylated state, it is a weak activator of transcription. However, when phosphorylated by PKA at key amino acids, CREB binds the coactivator **CREB-binding protein CBP/p300** (see below) and as a result is a much more potent transcriptional activator. CBP and the related p300 contain histone acetyltransferase activities (HATs), and hence serve as chromatin-active transcriptional coregulators (see [Chapters 36, 38](#)). Interestingly, CBP/p300 can also acetylate certain transcription factors thereby stimulating their ability to bind DNA and modulate transcription.

Phosphodiesterases

Actions caused by hormones that increase cAMP concentration can be terminated in a number of ways, including the hydrolysis of cAMP to 5'-AMP by phosphodiesterases (see [Figure 42–5](#)). The presence of these hydrolytic enzymes ensures a rapid turnover of the signal (cAMP) and hence a rapid termination of the biologic process once the hormonal

stimulus is removed. There are at least 11 known members of the phosphodiesterase family of enzymes. These are subject to regulation by their substrates, cAMP and cGMP; by hormones; and by intracellular messengers such as calcium, probably acting through calmodulin. Inhibitors of phosphodiesterase, most notably methylated xanthine derivatives such as caffeine, increase intracellular cAMP and mimic or prolong the actions of hormones through this signal.

Phosphoprotein Phosphatases

Given the importance of protein phosphorylation, it is not surprising that regulation of the protein dephosphorylation reaction is another important control mechanism (see [Figure 42–5](#)). The phosphoprotein phosphatases are themselves subject to regulation by phosphorylation-dephosphorylation reactions and by a variety of other mechanisms, such as protein–protein interactions. In fact, the substrate specificity of the phosphoserine-phosphothreonine phosphatases may be dictated by distinct regulatory subunits whose binding is regulated hormonally. One of the best-studied roles of regulation by the dephosphorylation of proteins is that of glycogen metabolism in muscle (see [Figures 18–6](#) to [18–8](#)). Two major types of phosphoserine-phosphothreonine phosphatases have been described. Type I preferentially dephosphorylates the β subunit of phosphorylase kinase, whereas type II dephosphorylates the α subunit. Type I phosphatase is implicated in the regulation of glycogen synthase, phosphorylase, and phosphorylase kinase. This phosphatase is itself regulated by phosphorylation of certain of its subunits, and these reactions are reversed by the action of one of the type II phosphatases. In addition, two heat-stable protein inhibitors regulate type I phosphatase activity. Inhibitor-1 is phosphorylated and activated by cAMP-dependent protein kinases, and inhibitor-2, which may be a subunit of the inactive phosphatase, is also phosphorylated, possibly by glycogen synthase kinase-3. Phosphatases that target phosphotyrosine are also important in signal transduction (see [Figure 42–8](#)).

cGMP Is Also an Intracellular Signal

Cyclic GMP is made from GTP by the enzyme guanylyl cyclase, which exists in soluble and membrane-bound forms. Each of these enzyme forms has unique physiologic properties. The atriopeptins, a family of peptides produced in cardiac atrial tissues, cause natriuresis, diuresis, vasodilation, and inhibition of aldosterone secretion. These peptides (eg, atrial

natriuretic factor) bind to and activate the membrane-bound form of guanylyl cyclase. This results in an increase of cGMP by as much as 50-fold in some cases, and this is thought to mediate the effects mentioned above. Other evidence links cGMP to vasodilation. A series of compounds, including nitroprusside, nitroglycerin, nitric oxide, sodium nitrite, and sodium azide, all cause smooth muscle relaxation and are potent vasodilators. These agents increase cGMP by activating the soluble form of guanylyl cyclase, and inhibitors of cGMP phosphodiesterase (eg, the drug sildenafil [Viagra]) enhance and prolong these responses. The increased cGMP activates cGMP-dependent protein kinase (PKG), which in turn phosphorylates a number of smooth muscle proteins. Presumably, this is involved in relaxation of smooth muscle and vasodilation.

Several Hormones Act Through Calcium or Phosphatidylinositols

Ionized calcium, Ca^{2+} , is an important regulator of a variety of cellular processes, including muscle contraction, stimulus-secretion coupling, the blood clotting cascade, enzyme activity, and membrane excitability. Ca^{2+} is also an intracellular messenger of hormone action.

Calcium Metabolism

The extracellular Ca^{2+} concentration is ~ 5 mmol/L and is very rigidly controlled. Although substantial amounts of calcium are associated with intracellular organelles such as mitochondria and the endoplasmic reticulum, the intracellular concentration of free or ionized calcium (Ca^{2+}) is very low: 0.05 to 10 $\mu\text{mol/L}$. In spite of this large concentration gradient and a favorable transmembrane electrical gradient, Ca^{2+} is restrained from entering the cell. A considerable amount of energy is expended to ensure that the intracellular Ca^{2+} is controlled, as a prolonged elevation of Ca^{2+} in the cell is very toxic. A $\text{Na}^+/\text{Ca}^{2+}$ exchange mechanism that has a high-capacity but low-affinity pumps Ca^{2+} out of cells. There also is a Ca^{2+} /proton ATPase-dependent pump that extrudes Ca^{2+} in exchange for H^+ . This has a high affinity for Ca^{2+} but a low capacity and is probably responsible for fine-tuning cytosolic Ca^{2+} . Furthermore, Ca^{2+} -ATPases pump Ca^{2+} from the cytosol to the lumen of the endoplasmic reticulum. There are three ways of changing cytosolic Ca^{2+} levels: (1) Certain

hormones (class II.C, [Table 41–3](#)) by binding to receptors that are themselves Ca^{2+} channels, enhance membrane permeability to Ca^{2+} , and thereby increase Ca^{2+} influx. (2) Hormones also indirectly promote Ca^{2+} influx by modulating the membrane potential at the plasma membrane. Membrane depolarization opens voltage-gated Ca^{2+} channels and allows for Ca^{2+} influx. (3) Ca^{2+} can be mobilized from the endoplasmic reticulum, and possibly from mitochondrial pools.

An important observation linking Ca^{2+} to hormone action involved the definition of the intracellular targets of Ca^{2+} action. The discovery of a Ca^{2+} -dependent regulator of phosphodiesterase activity provided the basis for a broad understanding of how Ca^{2+} and cAMP interact within cells.

Calmodulin

The calcium-dependent regulatory protein is calmodulin, a 17-kDa protein that is homologous to the muscle protein troponin C in structure and function. Calmodulin has four Ca^{2+} -binding sites, and full occupancy of these sites leads to a marked conformational change, which allows calmodulin to activate enzymes and ion channels. The interaction of Ca^{2+} with calmodulin (with the resultant change of activity of the latter) is conceptually similar to the binding of cAMP to PKA and the subsequent activation of this molecule. Calmodulin can be one of numerous subunits of complex proteins and is particularly involved in regulating various kinases and enzymes of cyclic nucleotide generation and degradation. A partial list of the enzymes regulated directly or indirectly by Ca^{2+} , probably through calmodulin, is presented in [Table 42–4](#).

TABLE 42–4 Some Enzymes and Proteins Regulated by Calcium or Calmodulin

- Adenylyl cyclase
- Ca²⁺-dependent protein kinases
- Ca²⁺-Mg²⁺-ATPase
- Ca²⁺-phospholipid-dependent protein kinase
- Cyclic nucleotide phosphodiesterase
- Some cytoskeletal proteins
- Some ion channels (eg, l-type calcium channels)
- Nitric oxide synthase
- Phosphorylase kinase
- Phosphoprotein phosphatase 2B
- Some receptors (eg, NMDA-type glutamate receptor)

Abbreviations: NDMA, N-methyl-D-aspartate receptor.

In addition to its effects on enzymes and ion transport, Ca²⁺/calmodulin regulates the activity of many structural elements in cells. These include the actin-myosin complex of smooth muscle, which is under β-adrenergic control, and various microfilament-mediated processes in noncontractile cells, including cell motility, cell conformation changes, mitosis, granule release, and endocytosis.

Calcium Is a Mediator of Hormone Action

A role for Ca²⁺ in hormone action is suggested by the observations that the effect of many hormones is (1) blunted by Ca²⁺-free media or when intracellular calcium is depleted; (2) can be mimicked by agents that increase cytosolic Ca²⁺, such as the Ca²⁺ ionophore A23187; and (3) influences cellular calcium flux. Again, the regulation of glycogen metabolism in liver (by vasopressin and β-adrenergic catecholamines; see [Figures 18–6](#) and [18–7](#)).

A number of critical metabolic enzymes are regulated by Ca²⁺, phosphorylation, or both. These include glycogen synthase, pyruvate kinase, pyruvate carboxylase, glycerol-3-phosphate dehydrogenase, and pyruvate dehydrogenase among others (see [Figure 19–1](#)).

Phosphatidylinositide Metabolism Affects Ca²⁺-Dependent Hormone Action

Some signal must provide communication between the hormone receptor on the plasma membrane and the intracellular Ca²⁺ reservoirs. This is accomplished by products of phosphatidylinositol metabolism. Cell surface receptors such as those for acetylcholine, antidiuretic hormone,

and α_1 -type catecholamines are, when occupied by their respective ligands, potent activators of phospholipase C. Receptor binding and activation of phospholipase C are coupled by the G_q isoforms (Table 42–3 and Figure 42–6). Phospholipase C catalyzes the hydrolysis of phosphatidylinositol 4,5-bisphosphate to inositol trisphosphate (IP_3) and 1,2-diacylglycerol (Figure 42–7). Diacylglycerol (**DAG**) is itself capable of activating **protein kinase C (PKC)**, the activity of which also depends on Ca^{2+} (see Chapter 21 and Figures, 24–1, 24–2, and 55–1). IP_3 , by interacting with a specific intracellular receptor, is an effective releaser of Ca^{2+} from intracellular storage sites in the endoplasmic reticulum. Thus, the hydrolysis of phosphatidylinositol 4,5-bisphosphate leads to activation of PKC and promotes an increase of cytoplasmic Ca^{2+} . As shown in Figure 42–4, the activation of G-proteins can also have a direct action on Ca^{2+} channels. The resulting elevations of cytosolic Ca^{2+} activate Ca^{2+} -calmodulin-dependent kinases and many other Ca^{2+} -calmodulin-dependent enzymes.

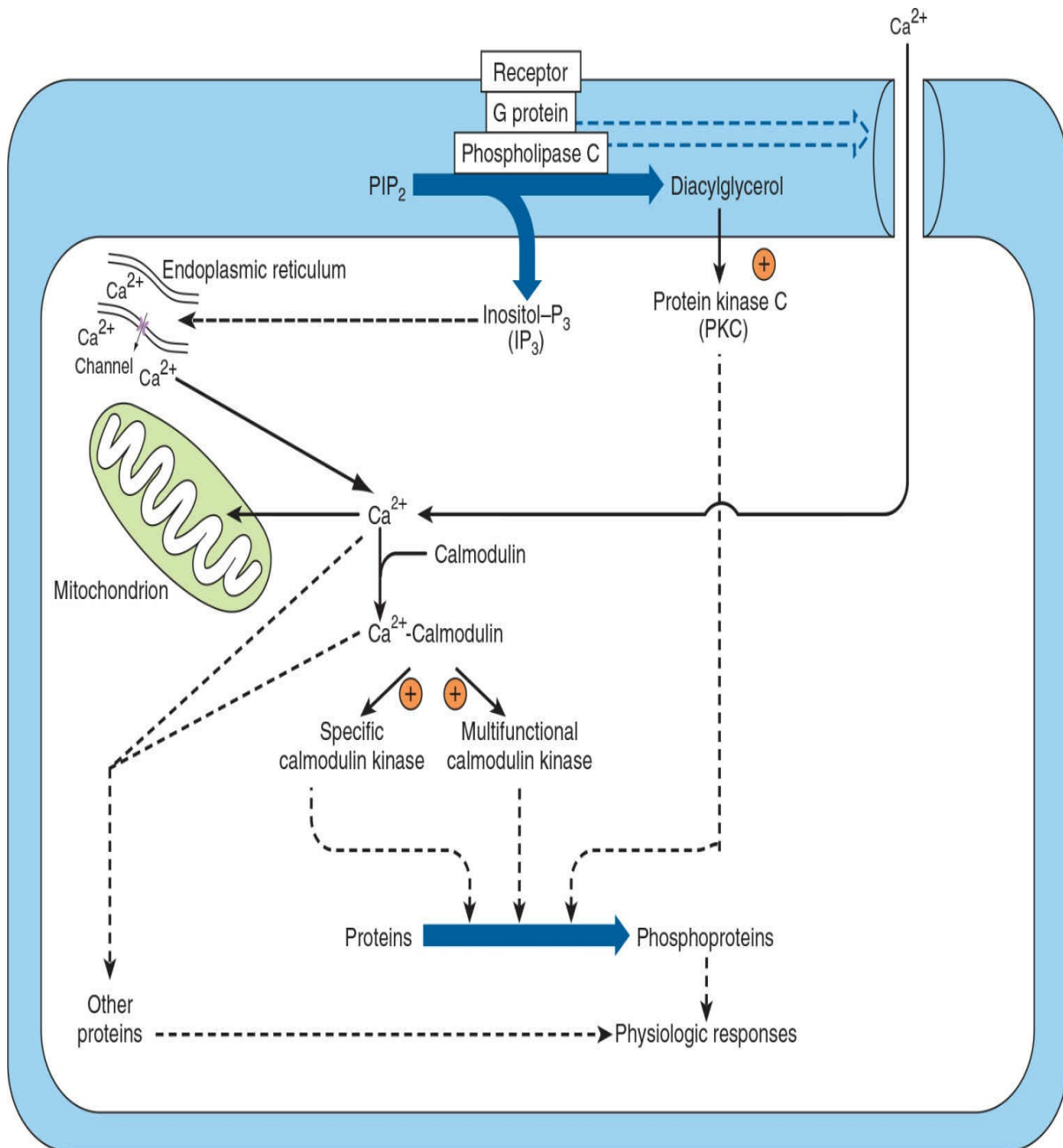

FIGURE 42–6 Certain hormone-receptor interactions result in the activation of phospholipase C (PLC). PLC activation appears to involve a specific G-protein, which also may activate a calcium channel. Phospholipase C generates inositol trisphosphate (IP₃) from PIP₂ (phosphoinositol 4,5-bisphosphate; see Figure 42–7), which liberates stored intracellular Ca²⁺, and diacylglycerol (DAG), a potent activator of protein kinase C (PKC). In this scheme, the activated PKC phosphorylates specific substrates, which then alter physiologic processes. Likewise, the Ca²⁺-calmodulin complex can activate specific kinases, two of which are shown here. These actions result in phosphorylation of substrates, and this

leads to altered physiologic responses. This figure also shows that Ca^{2+} can enter cells through voltage- or ligand-gated Ca^{2+} channels. The intracellular Ca^{2+} is also regulated through storage and release by the mitochondria and endoplasmic reticulum. (Reprinted with permission from JH Exton.)

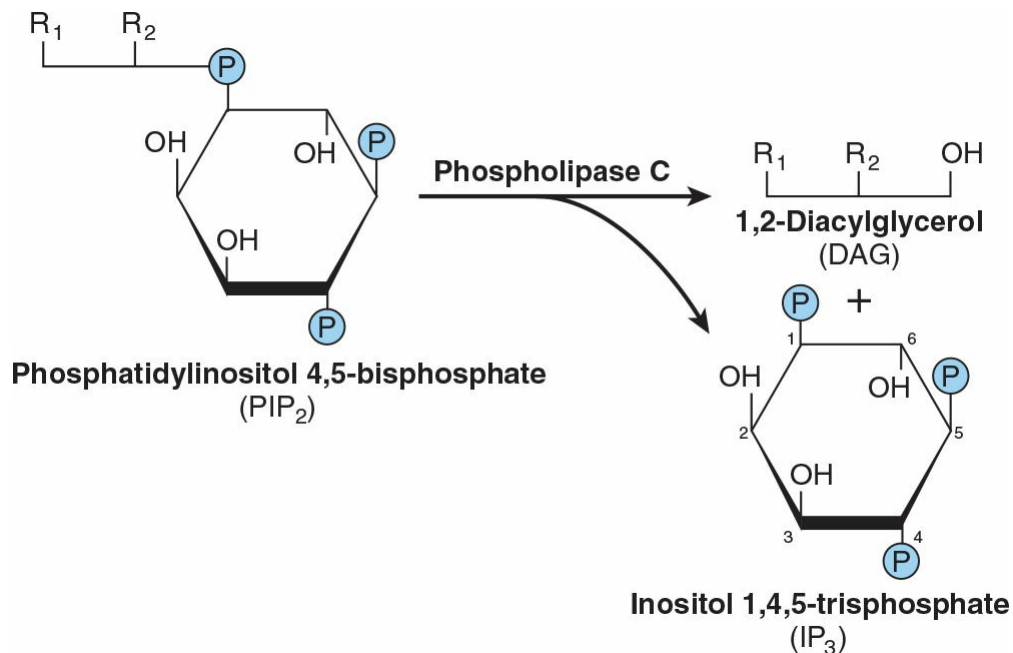

FIGURE 42–7 Phospholipase C cleaves PIP₂ into diacylglycerol and inositol trisphosphate. R₁ generally is stearate, and R₂ is usually arachidonate. IP₃ can be dephosphorylated (to the inactive I-1,4-P₂) or phosphorylated (to the potentially active I-1,3,4,5-P₄).

Steroidogenic agents—including ACTH and cAMP in the adrenal cortex; angiotensin II, K^+ , serotonin, ACTH, and cAMP in the zona glomerulosa of the adrenal; LH in the ovary; and LH and cAMP in the Leydig cells of the testes—have been associated with increased amounts of phosphatidic acid, phosphatidylinositol, and polyphosphoinositides (see [Chapter 21](#)) in the respective target tissues. Several other examples could be cited.

The roles that Ca^{2+} and polyphosphoinositide breakdown products might play in hormone action are presented in [Figure 42–6](#). In this scheme, the activated protein kinase C can phosphorylate specific substrates, which then alter physiologic processes. Likewise, the Ca^{2+} -calmodulin complex can activate specific kinases. These then modify substrates and thereby

alter physiologic responses.

Some Hormones Act Through a Protein Kinase Cascade

Single protein kinases such as PKA, PKC, and Ca²⁺-calmodulin (CaM) kinases, which result in the phosphorylation of serine and threonine residues in target proteins, play a very important role in hormone action. The discovery that the epidermal growth factor (EGF) receptor contains an intrinsic tyrosine kinase activity that is activated by the binding of the ligand EGF was an important breakthrough. The insulin and insulin-like growth factor 1 (IGF-1) receptors also contain intrinsic ligand-activated tyrosine kinase activity. Several receptors—generally those involved in binding ligands involved in growth control, differentiation, and the inflammatory response—either have intrinsic tyrosine kinase activity or are tightly associated with proteins that are tyrosine kinases. Another distinguishing feature of this class of hormone action is that these kinases preferentially phosphorylate tyrosine residues, and tyrosine phosphorylation is infrequent (<0.03% of total amino acid phosphorylation) in mammalian cells. A third distinguishing feature is that the ligand-receptor interaction that results in a tyrosine phosphorylation event initiates a cascade that may involve several protein kinases, phosphatases, and other regulatory proteins.

Insulin Transmits Signals by Several Kinase Cascades

The **insulin**, **EGF**, and **IGF-1 receptors** have intrinsic protein tyrosine kinase activities located in their cytoplasmic domains. These activities are stimulated when their ligands bind to the cognate receptor. The receptors are then autophosphorylated on tyrosine residues, and this phosphorylation initiates a complex series of events (summarized in simplified fashion in **Figure 42–8**). The phosphorylated insulin receptor next phosphorylates **insulin receptor substrates** (there are at least four of these molecules, called **IRS 1-4**) on tyrosine residues. Phosphorylated IRS binds to the **Src homology 2 (SH2)** domains of a variety of proteins that are directly involved in mediating different effects of insulin. One of these proteins, PI-3 kinase, links insulin receptor activation to insulin action through activation of a number of molecules, including the kinase phosphoinositide-dependent kinase 1 (**PDK1**). This enzyme propagates the signal through several other kinases, including **PKB** (also known as

AKT), **SKG**, and **aPKC** (see legend to [Figure 42–8](#) for definitions and expanded abbreviations). An alternative pathway downstream from PDK1 involves **p70S6K** and perhaps other as yet unidentified kinases. A second major pathway involves **mTOR**. This enzyme is directly regulated by amino acid levels and insulin and is essential for p70S6K activity. The mTOR-signaling system provides a distinction between the PKB and p70S6K branches downstream from PKD1. These pathways are involved in protein translocation, enzyme activation, and the regulation, by insulin, of genes involved in metabolism ([Figure 42–8](#)). Another SH2 domain-containing protein is **GRB2**, which binds to IRS-1 and links tyrosine phosphorylation to several proteins, the result of which is activation of a cascade of threonine and serine kinases. A pathway showing how this insulin-receptor interaction activates the mitogen-activated protein kinase (**MAPK**) pathway and the anabolic effects of insulin is illustrated in [Figure 42–8](#). The exact roles of many of these docking proteins, kinases, and phosphatases are actively being studied.

Response to hyperglycemia:

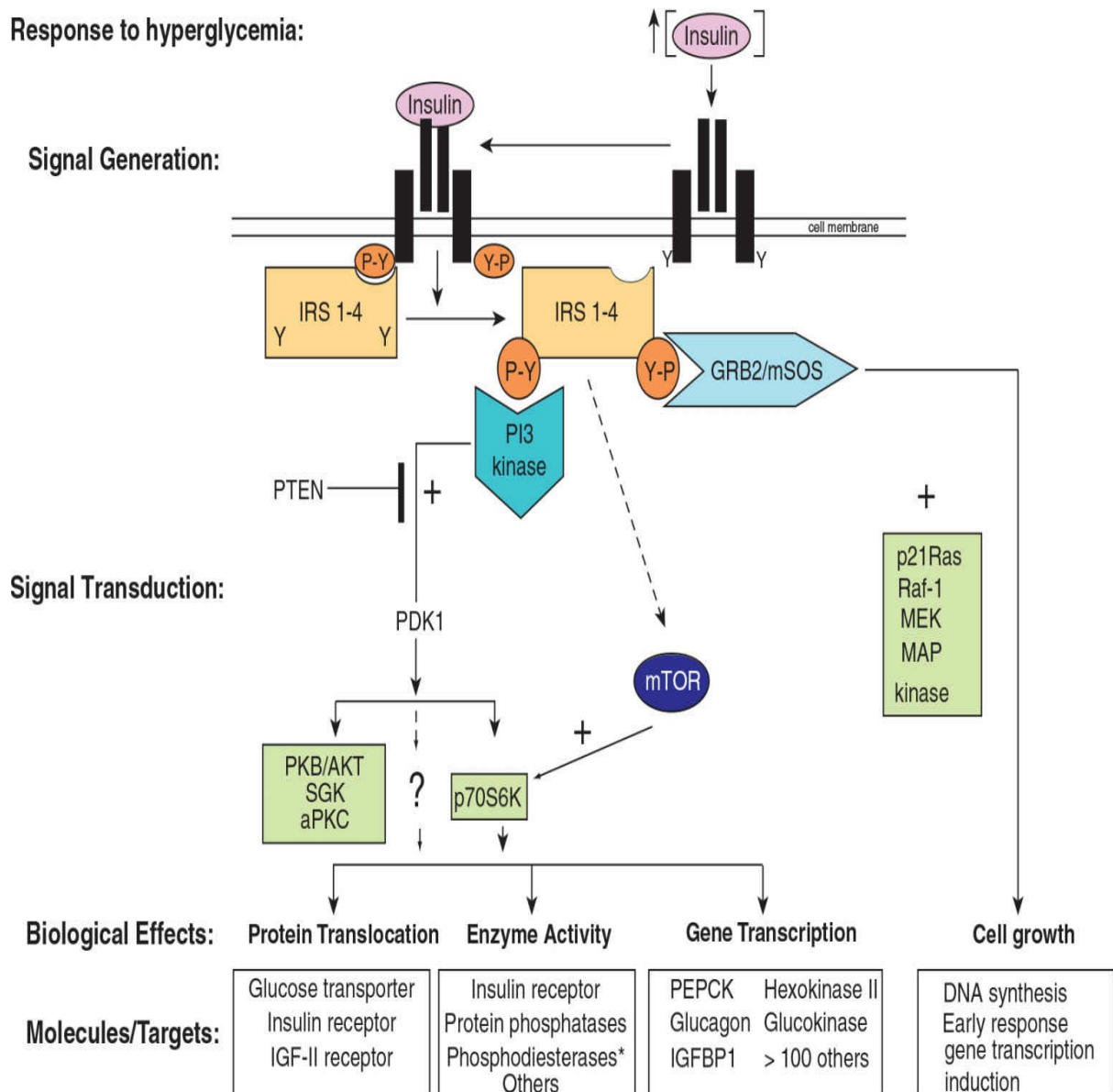

FIGURE 42–8 Insulin signaling pathways. The insulin signaling pathways provide an excellent example of the “recognition → hormone release → signal generation → effects” paradigm outlined in Figure 42–1. Insulin is released into the bloodstream from pancreatic β cells in response to hyperglycemia. Binding of insulin to a target cell-specific plasma membrane heterotetrameric insulin receptor (IR) results in a cascade of intracellular events. First, the intrinsic tyrosine kinase activity of the insulin receptor is activated, and marks the initial event. Receptor activation results in increased tyrosine phosphorylation (conversion of specific Y residues → Y-P) within the receptor. One or more of the insulin receptor substrate (IRS) molecules (IRS 1-4) then bind to the tyrosine-phosphorylated receptor and themselves are specifically tyrosine phosphorylated. IRS proteins interact with the activated IR via N-terminal

PH (pleckstrin homology) and phosphotyrosine binding (PTB) domains. IR-docked IRS proteins are tyrosine phosphorylated and the resulting P-Y residues form the docking sites for several additional signaling proteins (ie, PI-3 kinase, GRB2, and mTOR). GRB2 and PI-3K bind to IRS P-Y residues via their SH (*Src* homology) domains, binding to IRS-Y-P residues leads to activation of the activity of many intracellular signaling molecules such as GTPases, protein kinases, and lipid kinases, all of which play key roles in certain metabolic actions of insulin. The two best-described pathways are shown. In detail, phosphorylation of an IRS molecule (probably IRS-2) results in docking and activation of the lipid kinase, PI-3 kinase; PI-3K generates novel inositol lipids that act as “second messenger” molecules. These, in turn, activate PDK1 and then a variety of downstream signaling molecules, including protein kinase B (PKB/AKT), SGK, and aPKC. An alternative pathway involves the activation of p70S6K and perhaps other as yet unidentified kinases. Next, phosphorylation of IRS (probably IRS-1) results in docking of GRB2/mSOS and activation of the small GTPase, p21Ras, which initiates a protein kinase cascade that activates Raf-1, MEK, and the p42/p44 MAP kinase isoforms. These protein kinases are important in the regulation of proliferation and differentiation of many cell types. The mTOR pathway provides an alternative way of activating p70S6K and is involved in nutrient signaling as well as insulin action. Each of these cascades may influence different biologic processes, as shown (protein translocation, protein/enzyme activity, gene transcription, cell growth). All of the phosphorylation events are reversible through the action of specific phosphatases. As an example, the lipid phosphatase PTEN dephosphorylates the product of the PI-3 kinase reaction, thereby antagonizing the pathway and terminating the signal. Representative effects of major actions of insulin are shown in each of the boxes (bottom). The asterisk after phosphodiesterase indicates that insulin indirectly affects the activity of many enzymes by activating phosphodiesterases and reducing intracellular cAMP levels. (aPKC, atypical protein kinase C; GRB2, growth factor receptor binding protein 2; IGFBP, insulin-like growth factor binding protein; IRS 1-4, insulin receptor substrate isoforms 1-4; MAP kinase, mitogen-activated protein kinase; MEK, MAP kinase and ERK kinase; mSOS, mammalian son of sevenless; mTOR, mammalian target of rapamycin; p70S6K, p70 ribosomal protein S6 kinase; PDK1, phosphoinositide-dependent kinase; PI-3 kinase, phosphatidylinositol 3-kinase; PKB, protein kinase B; PTEN, phosphatase and tensin homolog deleted on chromosome 10; SGK, serum and

glucocorticoid-regulated kinase.

The Jak/STAT Pathway Is Used by Hormones and Cytokines

Tyrosine kinase activation can also initiate a phosphorylation and dephosphorylation cascade that involves the action of several other protein kinases and the counterbalancing actions of phosphatases. Two mechanisms are employed to initiate this cascade. Some hormones, such as growth hormone, prolactin, erythropoietin, and the cytokines, initiate their action by activating a tyrosine kinase, but this activity is not an integral part of the hormone receptor. The hormone-receptor interaction promotes binding and activation of **cytoplasmic protein tyrosine kinases**, such as **JAK1**, or **JAK2** or **TYK**.

These kinases phosphorylate one or more cytoplasmic proteins, which then associate with other docking proteins through binding to SH2 domains. One such interaction results in the activation of a family of cytosolic proteins called **STATs**, or **signal transducers and activators of transcription**. The phosphorylated STAT protein dimerizes and translocates into the nucleus, binds to a specific DNA element such as the interferon response element (IRE), and activates transcription. This is illustrated in **Figure 42–9**. Other SH2 docking events may result in the activation of PI-3 kinase, the MAP kinase pathway (through SHC or GRB2), or G-protein–mediated activation of phospholipase C (PLC γ) with the attendant production of diacylglycerol and activation of protein kinase C. It is apparent that there is a potential for “cross-talk” when different hormones activate these various signal transduction pathways.

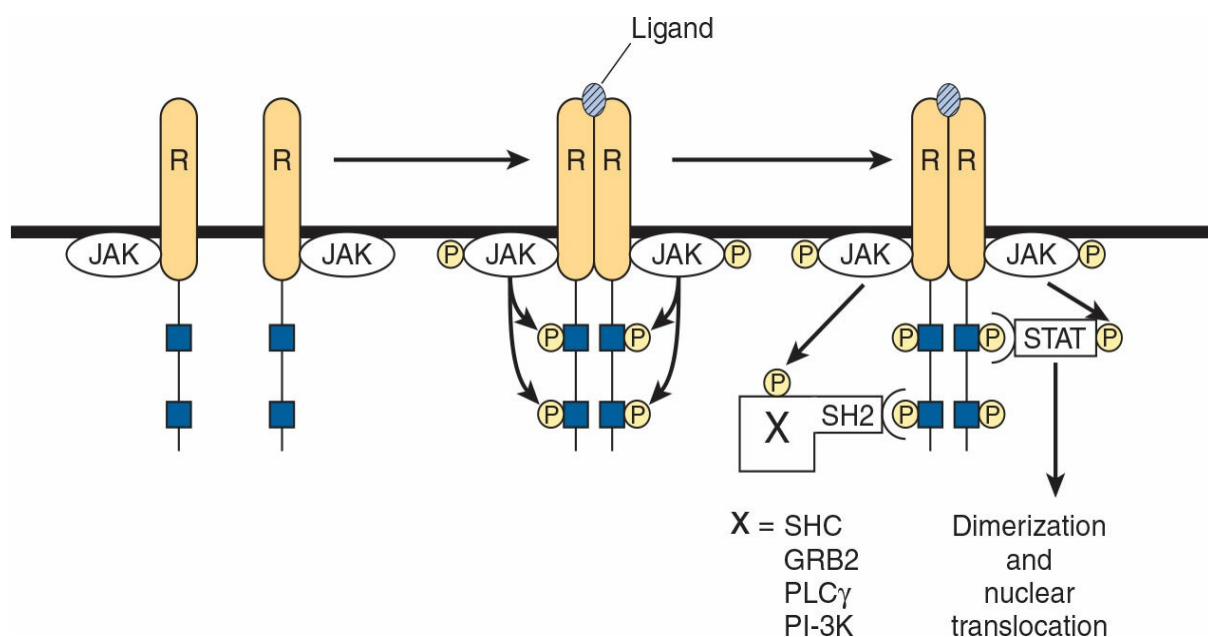

FIGURE 42–9 Initiation of signal transduction by receptors linked to Jak kinases. The receptors (R) that bind prolactin, growth hormone, interferons, and cytokines lack endogenous tyrosine kinase. Upon ligand binding, these receptors dimerize and an associated, though inactive protein kinase (JAK1, JAK2, or TYK) is phosphorylated. Phospho-JAK is now activated, and proceeds to phosphorylate the receptor on tyrosine residues. The STAT proteins associate with the phosphorylated receptor and then are themselves phosphorylated by JAK-P. The phosphorylated STAT protein, STAT $\text{\textcircled{P}}$ dimerizes, translocates to the nucleus, binds to specific DNA elements, and regulates transcription. The phosphotyrosine residues of the receptor also bind to several SH2 domain-containing proteins (X-SH2), which result in activation of the MAP kinase pathway (through SHC or GRB2), PLC γ , or PI-3 kinase.

The NF- κ B Pathway Is Regulated by Glucocorticoids

The DNA-binding transcription factor **NF- κ B** is a heterodimeric complex typically composed of two subunits termed **p50** and **p65** (**Figure 42–10**). Normally NF- κ B is sequestered in the cytoplasm in a transcriptionally inactive form by members of the **I κ B** (inhibitor of NF- κ B) family of proteins. Extracellular stimuli such as proinflammatory cytokines, reactive oxygen species, and mitogens lead to activation of the **IKK** (I κ B kinase) **complex**, which is a heterohexameric structure consisting of α , β , and γ subunits. IKK phosphorylates I κ B on two serine residues. This phosphorylation targets I κ B for polyubiquitylation and subsequent degradation by the proteasome. Following I κ B degradation, free NF- κ B translocates to the nucleus, where it binds to a number of gene enhancers and activates transcription, particularly of genes involved in the **inflammatory response**. Transcriptional regulation by NF- κ B is mediated by a variety of coactivators such as CREB-binding protein (CBP), as described below (**Figure 42–13**).

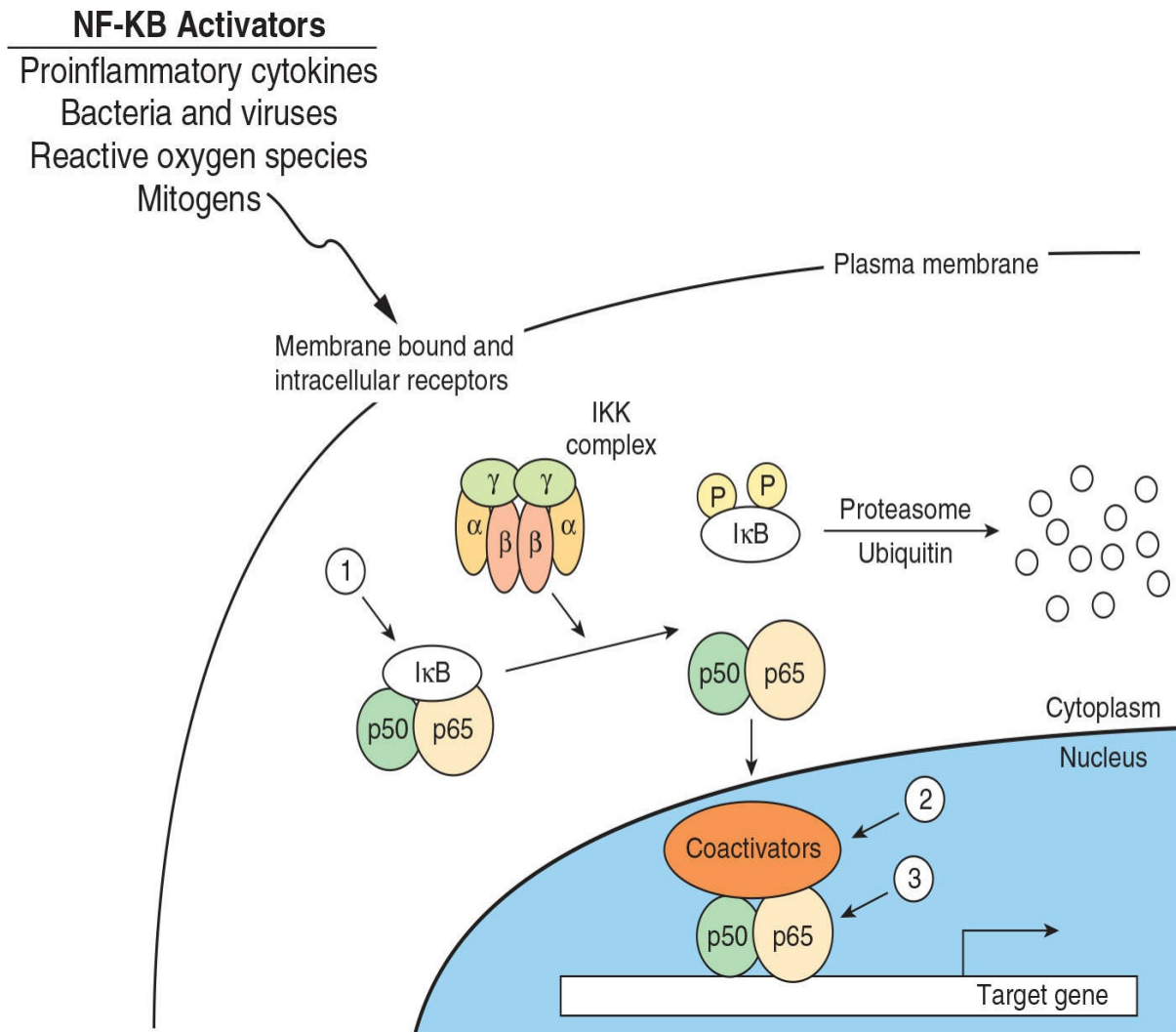

FIGURE 42–10 Regulation of the NF-κβ pathway. NF-κβ consists of two subunits, p50 and p65, which when present in the nucleus regulates transcription of the multitude of genes important for the inflammatory response. NF-κB is restricted from entering the nucleus by IκB, an inhibitor of NF-κB. IκB binds to—and masks—the nuclear localization signal of NF-κB. This cytoplasmic protein is phosphorylated by an IKK complex which is activated by cytokines, reactive oxygen species, and mitogens. Phosphorylated IκB can be ubiquitylated and degraded, thus releasing its hold on NF-κB, and allowing for nuclear translocation. Glucocorticoids, potent anti-inflammatory agents, are thought to affect at least three steps in this process (1, 2, 3), as described in the text.

Glucocorticoid hormones are therapeutically useful agents for the treatment of a variety of inflammatory and immune diseases. Their anti-inflammatory and immunomodulatory actions are explained in part by the inhibition of NF-κB and its subsequent actions. Evidence for three

mechanisms for the inhibition of NF- κ B by glucocorticoids has been described: (1) glucocorticoids increase I κ B mRNA, which leads to an increase of I κ B protein and more efficient sequestration of NF- κ B in the cytoplasm. (2) The glucocorticoid receptor competes with NF- κ B for binding to coactivators. (3) The glucocorticoid receptor directly binds to the p65 subunit of NF- κ B and inhibits its activation (Figure 42–10).

HORMONES CAN INFLUENCE SPECIFIC BIOLOGIC EFFECTS BY MODULATING TRANSCRIPTION

The signals generated as described above have to be translated into an action that allows the cell to effectively adapt to a challenge (Figure 42–1). Much of this adaptation is accomplished through alterations in the rates of transcription of specific genes. Many different observations have led to the current view of how hormones affect transcription. Some of these are as follows: (1) actively transcribed genes are in regions of “open” chromatin (experimentally defined as relative susceptibility to the enzyme DNase I, and containing certain histone PTMs or “marks”), which allows for the access of transcription factors to DNA. (2) Genes have regulatory regions, and transcription factors bind to these to modulate the frequency of transcription initiation. (3) The hormone-receptor complex can be one of these transcription factors. The DNA sequence to which receptors bind is called a **HRE** (see Table 42–1 for examples). (4) Alternatively, other hormone-generated signals can modify the location, amount, or activity of transcription factors and thereby influence binding to the regulatory or response element. (5) Members of a large superfamily of nuclear receptors act with—or in a manner analogous to—the hormone receptors described above. (6) These nuclear receptors interact with another large group of coregulatory molecules to effect changes in the transcription of specific genes.

Several HREs Have Been Defined

HREs resemble enhancer elements in that they are not strictly dependent on position and location or orientation. They generally are found within a few hundred nucleotides upstream (5') of the transcription initiation site, but they may be located within the coding region of the gene, in introns. HREs were defined by the strategy illustrated in Figure 38–11. The consensus sequences illustrated in Table 42–1 were arrived at through

analysis of many genes regulated by a given hormone using simple, heterologous reporter systems (see [Figure 38–10](#)). Although these simple HREs bind the hormone-receptor complex more avidly than surrounding DNA—or DNA from an unrelated source—and confer hormone responsiveness to a reporter gene, it soon became apparent that the regulatory circuitry of natural genes must be much more complicated. Glucocorticoids, progestins, mineralocorticoids, and androgens have vastly different physiologic actions. How could the specificity required for these effects be achieved through regulation of gene expression by the same HRE ([Table 42–1](#))? Questions like this have led to experiments which have allowed for elaboration of a more complex model of transcription regulation by the steroid hormone receptor family of proteins. For example, in the vast majority of cellular genes, the HRE is found associated with other specific regulatory DNA elements (and associated binding proteins); these associations are mandatory for optimal function. The extensive sequence similarity noted between steroid hormone receptors, particularly in their DNA-binding domains (DBD), led to discovery of the **nuclear receptor superfamily** of proteins. These—and a large number of **coregulator proteins**—allow for a wide variety of DNA–protein and protein–protein interactions and the specificity necessary for highly regulated physiologic control. A schematic of such an assembly is illustrated in [Figure 42–11](#).

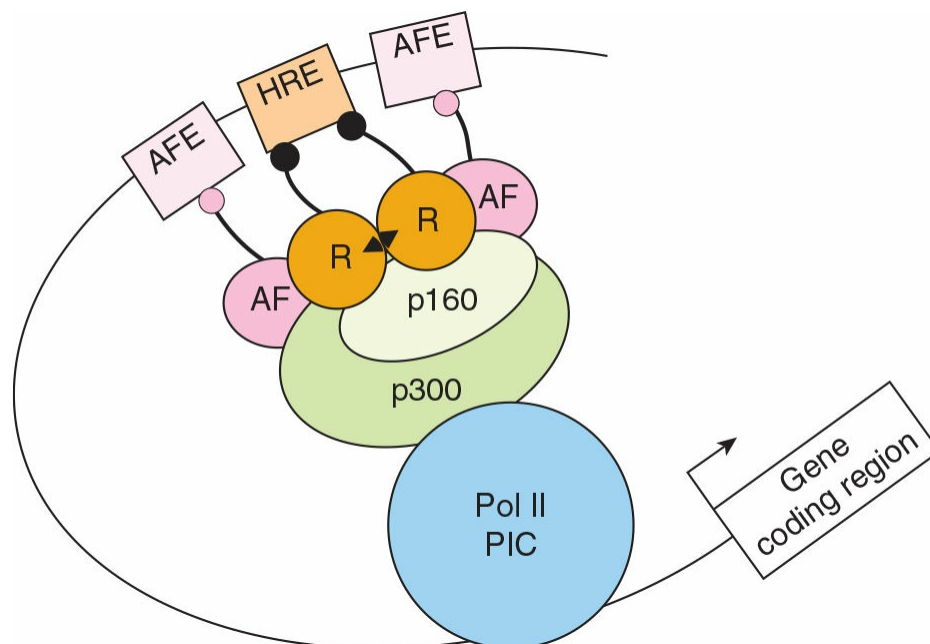

FIGURE 42–11 The hormone response transcriptional activation unit. The hormone response transcription unit is an assembly of DNA

elements and complementary, cognate DNA-bound proteins that interact, through protein–protein interactions, with a number of coactivator or corepressor molecules. An essential component is the hormone response element that is bound by the ligand (▲)-bound receptor (R). Also important are the accessory factor elements (AFE) with bound transcription factors. More than two dozen of these accessory factors (AFs), which are often members of the nuclear receptor superfamily, have been linked to hormone effects on transcription. The AFs can interact with each other, with the liganded nuclear receptors, or with coregulators. These components communicate with the basal transcription machinery, forming the polymerase II PIC (ie, RNAP II and GTFs; [Figure 36–10](#)) through a coregulator complex that can consist of one or more members of the p160, corepressor, mediator-related, or CBP/p300 families (see [Table 42–6](#)). Recall (see [Chapters 36, 38](#)) that many of the transcription coregulators carry intrinsic enzymatic activities that covalently modify the DNA, transcription proteins, and the histones present in the nucleosomes (not shown here) in and around the enhancer (HRE, AFE) and promoter. Collectively the hormone, hormone receptor, chromatin, DNA and transcription machinery integrate and process hormone signals to regulate transcription in a physiologic fashion.

There Is a Large Family of Nuclear Receptor Proteins

The nuclear receptor superfamily consists of a diverse set of transcription factors that were discovered because of a sequence similarity in their DBDs. This family, now with >50 members, includes the nuclear hormone receptors discussed above, a number of other receptors whose ligands were discovered after the receptors were identified, and many putative or orphan receptors for which a ligand has yet to be discovered.

These nuclear receptors have several common structural features ([Figure 42–12](#)). All have a centrally located DBD that allows the receptor to bind with high affinity to its cognate HRE. The DBD contains two zinc finger binding motifs (see [Figure 38–14](#)) that direct binding either as homodimers, as heterodimers (usually with a retinoid X receptor [RXR] partner), or as monomers. The target response element consists of one or two DNA half-site consensus sequences arranged as an inverted or direct repeat. The spacing between the latter helps determine binding specificity. Thus, in general, a direct repeat with three, four, or five nucleotide spacer regions specifies the binding of the vitamin D, thyroid, and retinoic acid receptors, respectively, to the same consensus response element ([Table](#)

42–1). A multifunctional **ligand-binding domain (LBD)** is located in the carboxyl terminal half of the receptor. The LBD binds hormones or metabolites with selectivity and thus specifies a particular biologic response. The LBD also contains domains that mediate the binding of heat shock proteins, dimerization, nuclear localization, and transactivation. The latter function is facilitated by the carboxyl-terminal transcription activation function, or **activation domain/AD (AF-2 domain)**, which forms a surface required for the interaction with coactivators. A highly variable **hinge region** separates the DBD from the LBD. This region provides flexibility to the receptor, so it can assume different DNA-binding conformations. Finally, there is a highly variable amino-terminal region that contains another AD referred to as **AF-1**. The AF-1 AD likely provides for distinct physiologic functions through the binding of different coregulator proteins. This region of the receptor, through the use of different promoters, alternative splice sites, and multiple translation initiation sites, provides for receptor isoforms that share DBD and LBD identity but exert different physiologic responses because of the association of various coregulators with this variable amino terminal AF-1 AD.

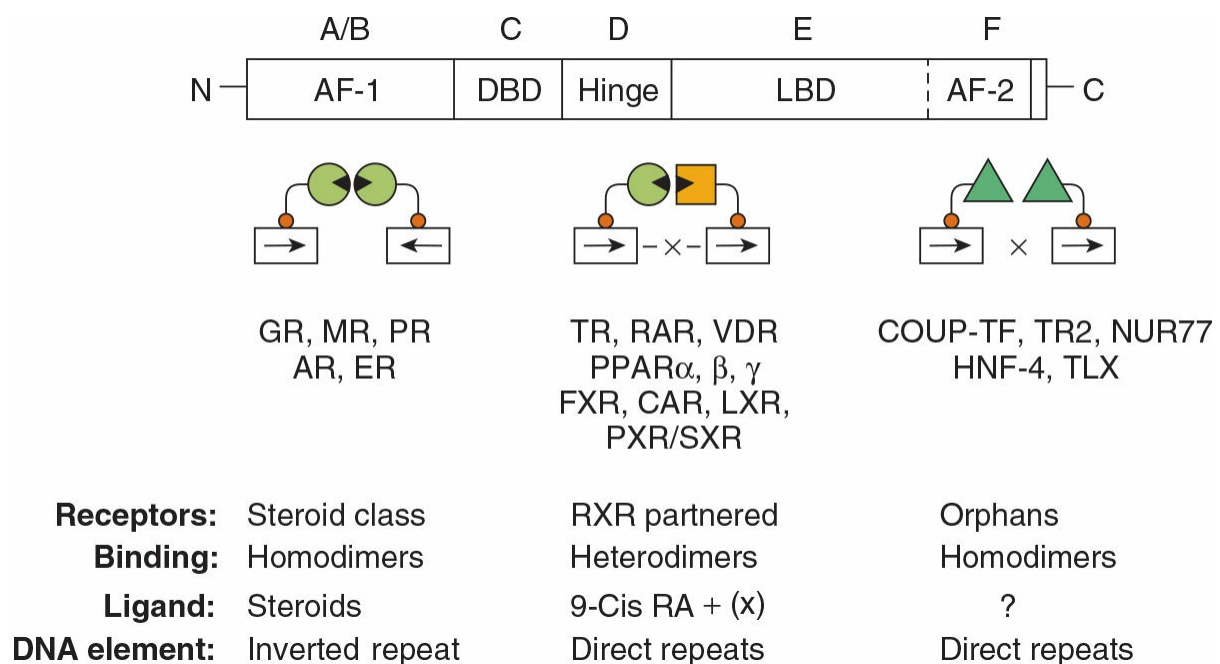

FIGURE 42–12 The nuclear receptor superfamily. Members of this family are divided into six structural domains (A-F). Domain A/B is also called AF-1, or the modulator region, because it contains an AD and is involved in activating transcription. The C domain consists of the DNA-binding domain (DBD). The D region contains the hinge, which provides

flexibility between the DBD and the ligand-binding domain (LBD, region E). The C-terminal part of region E contains AF-2, another AD that also contributes importantly to activation of transcription. The F region is less well defined. The functions of these domains are discussed in more detail in the text. Receptors with known ligands, such as the steroid hormones, bind as homodimers on inverted repeat half-sites. Other receptors form heterodimers with the partner RXR on direct repeat elements. There can be nucleotide spacers of one to five bases between these direct repeats (DR1-5; see [Table 42–1](#) for more details). Another class of receptors for which ligands have not been definitively determined (orphan receptors) bind as homodimers to direct repeats and occasionally as monomers to a single half-site.

It is possible to sort this large number of receptors into groups in a variety of ways. Here, they are discussed according to the way they bind to their respective DNA elements ([Figure 42–12](#)). Classic hormone receptors for glucocorticoids (GR), mineralocorticoids (MR), estrogens (ER), androgens (AR), and progestins (PR) bind as homodimers to inverted repeat sequences. Other hormone receptors such as thyroid (TR), retinoic acid (RAR), and vitamin D (VDR) and receptors that bind various metabolite ligands such as PPAR α , β , and γ , FXR, LXR, PXR, and CAR bind as heterodimers, with RXR as a partner, to direct repeat sequences (see [Figure 42–12](#) and [Table 42–5](#)). Another group of orphan receptors that as yet have no known ligand bind as homodimers or monomers to direct repeat sequences.

TABLE 42–5 Nuclear Receptors With Special Ligands^a

Receptor	Partner	Ligand	Process Affected	
Peroxisome	PPAR _α	RXR (DR1)	Fatty acids	Peroxisome proliferation
Proliferator-activated	PPAR _β		Fatty acids	Lipid and carbohydrate metabolism
	PPAR _γ		Fatty acids Eicosanoids, thiazolidinediones	
Farnesoid X	FXR	RXR (DR4)	Farnesol, bile acids	Bile acid metabolism
Liver X	LXR	RXR (DR4)	Oxysterols	Cholesterol metabolism
Xenobiotic X	CAR	RXR (DR5)	Androstanes phenobarbital xenobiotics	Protection against certain drugs, toxic metabolites, and xenobiotics
	PXR	RXR (DR3)	Pregnanes Xenobiotics	

*Many members of the nuclear receptor superfamily were discovered by "homology" cloning, and the corresponding ligands were subsequently identified. These ligands are not hormones in the classic sense, but they do have a similar function in that they activate specific members of the nuclear receptor superfamily. The receptors described here form heterodimers with RXR and have variable nucleotide sequences separating the direct repeat binding elements (DR1-5). These receptors regulate a variety of genes encoding cytochrome p450s (CYP), cytosolic binding proteins, and ATP-binding cassette (ABC) transporters to influence metabolism and protect cells against drugs and noxious agents.

As illustrated in [Table 42–5](#), the discovery of the nuclear receptor superfamily has led to an important understanding of how a variety of metabolites and xenobiotics regulate gene expression and thus the metabolism, detoxification, and elimination of normal body products and exogenous agents such as pharmaceuticals. Not surprisingly, this area is a fertile field for investigation of new therapeutic interventions.

A Large Number of Nuclear Receptor Coregulators Also Participate in Regulating Transcription

Chromatin remodeling (histone modifications, DNA methylation, nucleosome repositioning/remodeling/displacement) transcription factor modification by various enzyme activities, and the communication between the nuclear receptors and the basal transcription apparatus are accomplished by protein–protein interactions with one or more of a class of coregulator molecules. The number of these coregulator molecules now exceeds 100, not counting species variations and splice variants. The first of these to be described was the **CREB-binding protein, CBP**. CBP, through an amino-terminal domain, binds to phosphorylated serine 137 of

CREB and mediates transactivation in response to cAMP. It thus is described as a coactivator. CBP and its close relative, p300, interact directly or indirectly with a number of DNA-binding transcription factors, including **activator protein-1 (AP-1)**, **STATs**, **nuclear receptors**, and **CREB (Figure 42–13)**. **CBP/p300** also binds to the p160 family of coactivators described below and to a number of other proteins, including the p90^{rsk} protein kinase and RNA helicase A. It is important to note, as mentioned above, that **CBP/p300** also has **intrinsic histone acetyltransferase (HAT) activity**. Some of the many actions of CBP/p300, which appear to depend on intrinsic enzyme activities and its ability to serve as a scaffold for the binding of other proteins, are illustrated in [Figure 42–11](#). Other coregulators serve similar functions.

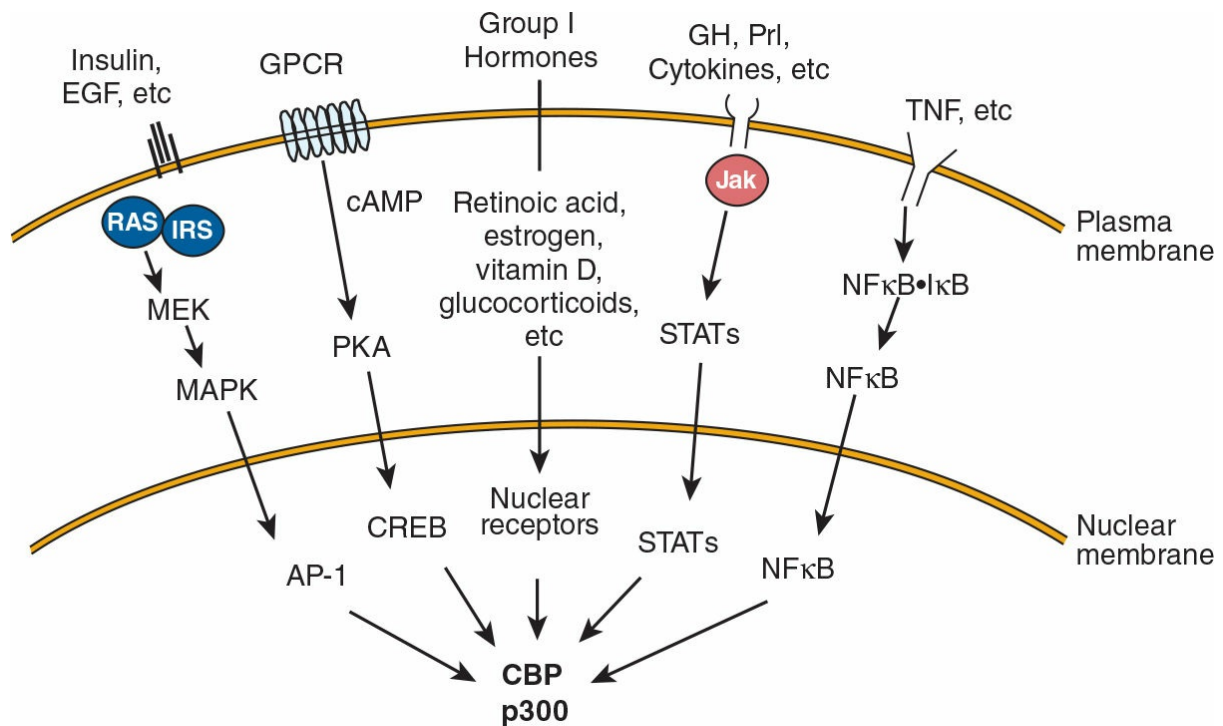

FIGURE 42–13 Several signal transduction pathways converge on CBP/p300. Many ligands that associate with membrane or nuclear receptors eventually converge on CBP/p300. Several different signal transduction pathways are illustrated. (EGF, epidermal growth factor; GH, growth hormone; Prl, prolactin; TNF, tumor necrosis factor; other abbreviations are expanded in the text.)

Several other families of coactivator molecules have been described. Members of the **p160 family of coactivators**, all of about 160 kDa, include (1) SRC-1 and NCoA-1; (2) GRIP 1, TIF2, and NCoA-2; and (3) p/CIP, ACTR, AIB1, RAC3, and TRAM-1 ([Table 42–6](#)). The different

names for members within a subfamily often represent species variations or minor splice variants. There is about 35% amino acid identity between members of the different subfamilies. The p160 coactivators share several properties. They (1) bind nuclear receptors in an agonist- and AF-2 AD-dependent manner, (2) have a conserved amino terminal basic helix-loop-helix (bHLH) motif (see [Chapter 38](#)), (3) have a weak carboxyl-terminal transactivation domain and a stronger amino-terminal transactivation domain in a region that is required for CBP-p160 interaction, (4) contain at least three of the **LXXLL motifs** required for protein–protein interaction with other coactivators, and (5) often have HAT activity. The role of HAT is particularly interesting, as mutations of the HAT domain disable many of these transcription factors. Current thinking holds that these HAT activities acetylate histones, which facilitate the remodeling of chromatin into a transcription-efficient environment. Histone acetylation/deacetylation thus plays a critical role in gene expression. Finally, it is important to note that other protein substrates for HAT-mediated acetylation, such as DNA-binding transcription activators and other coregulators have been reported. Such nonhistone PTM events likely also factor importantly into the overall regulatory response.

TABLE 42–6 Some Mammalian Coregulator Proteins

I. 300-kDa family of coactivators	
A. CBP	CREB-binding protein
B. p300	Protein of 300 kDa
II. 160-kDa family of coactivators	
A. SRC-1,2,3	Steroid receptor coactivator 1, 2, and 3
NCoA-1	Nuclear receptor coactivator 1
B. TIF2	Transcriptional intermediary factor 2
GRIP1	Glucocorticoid receptor-interacting protein
NCoA-2	Nuclear receptor coactivator 2
C. p/CIP	p300/CBP cointegrator-associated protein 1
ACTR	Activator of the thyroid and retinoic acid receptors
AIB	Amplified in breast cancer
RAC3	Receptor-associated coactivator 3
TRAM-1	TR activator molecule 1
III. Corepressors	
A. NCoR	Nuclear receptor corepressor
B. SMRT	Silencing mediator for RXR and TR
IV. Mediator subunits	
A. TRAPs	Thyroid hormone receptor-associated proteins
B. DRIPs	Vitamin D receptor-interacting proteins
C. ARC	Activator-recruited cofactor

A small number of proteins, including **NCoR** and **SMRT**, comprise the

corepressor family. They function, at least in part, as described in [Figure 42–2](#). Another family includes the TRAPs, DRIPs, and ARC ([Table 42–6](#)). These proteins represent subunits of the mediator (see [Chapter 36](#)) and range in size from 80 to 240 kDa and are thought to link the nuclear receptor-coactivator complex to RNA polymerase II and the other components of the basal transcription apparatus.

The exact role of these coactivators is presently under intensive investigation. Many of these proteins have intrinsic enzymatic activities. This is particularly interesting in view of the fact that acetylation, phosphorylation, methylation, sumoylation, and ubiquitination—as well as proteolysis and cellular translocation—have been proposed to alter the activity of some of these coregulators and their targets.

It appears that certain combinations of coregulators—and thus different combinations of activators and inhibitors—are responsible for specific ligand-induced actions through various receptors. Furthermore, these interactions on a given promoter are dynamic. In some cases, complexes consisting of over 45 transcription factors have been observed on a single gene.

SUMMARY

- Hormones, cytokines, interleukins, and growth factors use a variety of signaling mechanisms to facilitate cellular adaptive responses.
- The ligand-receptor complex serves as the initial signal for members of the nuclear receptor family.
- Class II peptide/protein and catecholamine hormones, which bind to cell surface receptors, generate a variety of intracellular signals. These include cAMP, cGMP, Ca²⁺, phosphatidylinositides, and protein kinase cascades.
- Many hormone responses are accomplished through alterations in the rate of transcription of specific genes.
- The nuclear receptor superfamily of proteins plays a central role in the regulation of gene transcription.
- DNA-binding nuclear receptors, which may have hormones, metabolites, or drugs as ligands, bind to specific HREs as homodimers or as heterodimers with RXR.
- Another large family of coregulator proteins remodel chromatin, modify other transcription factors, and bridge the nuclear receptors to the basal transcription apparatus.

REFERENCES

- Arvanitakis L, Geras-Raaka E, Gershengorn MC: Constitutively signaling G-protein-coupled receptors and human disease. *Trends Endocrinol Metab* 1998;9:27.
- Beene DL, Scott JD: A-kinase anchoring proteins take shape. *Curr Opin in Cell Biol* 2007;19:192.
- Cheung E, Kraus WL: Genomic analyses of hormone signaling and gene regulation. *Annu Rev Physiol* 2010;72:191-218.
- Cohen P, Spiegelman BM: Cell biology of fat storage. *Mol Biol Cell* 2016;27:2523-2527.
- Darnell JE Jr, Kerr IM, Stark GR: Jak-STAT pathways and transcriptional activation in response to IFNs and other extracellular signaling proteins. *Science* 1994;264:1415.
- Dasgupta S, Lonard DM, O'Malley BW: Nuclear receptor coactivators: master regulators of human health and disease. *Annu Rev Med* 2014;65:279-292.
- Fan W, Evans RM: Exercise mimetics: impact on health and performance. *Cell Metab* 2017;25:242-247.
- Fantl WJ, Johnson DE, Williams LT: Signalling by receptor tyrosine kinases. *Annu Rev Biochem* 1993;62:453.
- Jaken S: Protein kinase C isozymes and substrates. *Curr Opin Cell Biol* 1996;8:168.
- Kobilka BK: Structural insights into adrenergic receptor function and pharmacology. *Trends Pharmacol Sci* 2011;32:213-218.
- Lazar MA: Maturing the nuclear receptor family. *J Clin Invest* 2017; 127:1123-1125.
- Manglik A, Kobilka B: The role of protein dynamics in GPCR function: insights from the β 2AR and rhodopsin. *Curr Opin Cell Biol* 2014;27:136-143.
- Métivier R, Reid G, Gannon F: Transcription in four dimensions: nuclear receptor-directed initiation of gene expression. *EMBO Rep* 2006;7:161.
- O'Malley B: Coregulators: from whence came these "master genes." *Mol Endocrinol* 2007;21:1009.
- Ravnskjaer K, Madiraju A, Montminy M: Role of the cAMP pathway in glucose and lipid metabolism. *Handb Exp Pharmacol* 2016;233:29-49.
- Reiter E, Ahn S, Shukla AK: Molecular mechanism of β -arrestin-biased agonism at seven-transmembrane receptors. *Annu Rev Pharmacol Toxicol* 2012;52:179-197.

- Szwarc MM, Lydon JP, O'Malley BW: Steroid receptor coactivators as therapeutic targets in the female reproductive system. *J Steroid Biochem Mol Biol* 2015;154:32-38.
- Wang Z, Schaffer NE, Kliewer SA, Mangelsdorf DJ: Nuclear receptors: emerging drug targets for parasitic diseases. *J Clin Invest* 2017;127:1165-1171.
- Weikum ER, Knuesel MT, Ortlund EA, Yamamoto KR: Glucocorticoid receptor control of transcription: precision and plasticity via allostery. *Nat Rev Mol Cell Biol* 2017;18:159-174.
- Zhang Q, Lenardo MJ, Baltimore D: 30 years of NF- κ B: a blossoming of relevance to human pathobiology. *Cell* 2017;168:37-57.

Exam Questions

Section VIII – Biochemistry of Extracellular & Intracellular Communication

1. Regarding membrane lipids, select the one FALSE answer.
 - A. The major phospholipid by mass in human membranes is generally phosphatidylcholine.
 - B. Glycolipids are located on the inner and outer leaflets of the plasma membrane.
 - C. Phosphatidic acid is a precursor of phosphatidylserine, but not of sphingomyelin.
 - D. Phosphatidylcholine and phosphatidylethanolamine are located primarily on the outer leaflet of the plasma membrane.
 - E. The flip-flop of phospholipids in membranes is very slow.
2. Regarding membrane proteins, select the one FALSE answer.
 - A. Because of steric considerations, α -helices cannot exist in membranes.
 - B. A hydrophathy plot helps one to estimate whether a segment of a protein is predominantly hydrophobic or hydrophilic.

- C. Certain proteins are anchored to the outer leaflet of plasma membranes via glycosylphosphatidylinositol (GPI) structures.
 - D. Adenylyl cyclase is a marker enzyme for the plasma membrane.
 - E. Myelin has a very high content of lipid compared with protein.
3. Regarding membrane transport, select the one FALSE statement.
- A. Potassium has a lower charge density than sodium and tends to move more quickly through membranes than does sodium.
 - B. The flow of ions through ion channels is an example of passive transport.
 - C. Facilitated diffusion requires a protein transporter.
 - D. Inhibition of the $\text{Na}^+ - \text{K}^+ - \text{ATPase}$ will inhibit sodium-dependent uptake of glucose in intestinal cells.
 - E. Insulin, by recruiting glucose transporters to the plasma membrane, increases uptake of glucose in fat cells but not in muscle.
4. Regarding the $\text{Na}^+ - \text{K}^+ - \text{ATPase}$, select the one FALSE statement.
- A. Its action maintains the high intracellular concentration of sodium compared with potassium.
 - B. It can use as much as 30% of the total ATP expenditure of a cell.
 - C. It is inhibited by digitalis, a drug that is useful in certain cardiac conditions.
 - D. It is located in the plasma membrane of cells.
 - E. Phosphorylation is involved in its mechanism of action, leading to its classification as a P-type ATP-driven active transporter.
5. What molecules enable cells to respond to a specific extracellular signaling molecule?
- A. Specific receptor carbohydrates localized to the inner plasma membrane surface
 - B. Plasma lipid bilayer
 - C. Ion channels
 - D. Receptors that specifically recognize and bind that particular messenger molecule
 - E. Intact nuclear membranes

6. Indicate the term generally applied to the extracellular messenger molecules that bind to transmembrane receptor proteins.
 - A. Competitive inhibitor
 - B. Ligand
 - C. Scatchard curve
 - D. Substrate
 - E. Key

7. In autocrine signaling:
 - A. Messenger molecules reach their target cells via passage through bloodstream.
 - B. Messenger molecules travel only short distances through the extracellular space to cells that are in close proximity to the cell that is generating the message.
 - C. The cell producing the messenger expresses receptors on its surface that can respond to that messenger.
 - D. The messenger molecules are usually rapidly degraded and hence can only work over short distances.

8. Regardless of how a signal is initiated, the ligand-binding event is propagated via second messengers or protein recruitment. What is the ultimate, or final biochemical outcome of these binding events?
 - A. A protein in the middle of an intracellular signaling pathway is activated.
 - B. A protein at the bottom of an intracellular signaling pathway is activated.
 - C. A protein at the top of an extracellular signaling pathway is activated.
 - D. A protein at the top of an intracellular signaling pathway is deactivated.
 - E. A protein at the top of an intracellular signaling pathway is activated.

9. What features of the nuclear receptor superfamily suggest that these proteins have evolved from a common ancestor?
 - A. They all bind the same ligand with high affinity.
 - B. They all function within the nucleus.

- C. They are all subject to regulatory phosphorylation.
 - D. They all contain regions of high amino acid sequence similarity/identity.
 - E. They all bind DNA.
10. What effect does degradation of receptor-ligand complexes after internalization have upon the ability of a cell to respond if immediately reexposed to the same hormone?
- A. The cellular response is attenuated due to a decrease in cellular receptor number.
 - B. Cellular response is enhanced due to reduced receptor-ligand competition.
 - C. The cellular response is unchanged to subsequent stimuli.
 - D. Cell hormone response is now bimodal; enhanced for a short time and thereafter inactivated.
11. Typically, what is the first reaction after most receptor protein-tyrosine kinases (RTKs) bind their ligand?
- A. Receptor trimerization
 - B. Receptor degradation
 - C. Receptor denaturation
 - D. Receptor dissociation
 - E. Receptor dimerization
12. Where is the kinase catalytic domain of the receptor protein-tyrosine kinases found?
- A. On the extracellular surface of the receptor, immediately adjacent to the ligand-binding domain.
 - B. On the cytoplasmic domain of the receptor.
 - C. On an independent protein that rapidly binds the receptor upon ligand binding.
 - D. Within the transmembrane spanning portion of the receptor.
13. The subunits of the heterotrimeric G-proteins are called the __, __, and__ subunits.
- A. α , β , and χ
 - B. α , β , and δ

- C. α , γ , and δ
 - D. α , β , and γ
 - E. γ , δ , and η
14. Of the receptors listed below, which can directly conduct a flow of ions across the plasma membrane when bound to their cognate ligand?
- A. Receptor tyrosine kinases (RTKs)
 - B. G-protein–coupled receptors (GPCRs)
 - C. G-protein gamma α subunit.
 - D. Steroid hormone receptors
 - E. Ligand-gated channels
15. Which of the following is NOT a natural ligand that binds to G-protein–coupled receptors?
- A. Hormones
 - B. Steroid hormones
 - C. Chemoattractants
 - D. Opium derivatives
 - E. Neurotransmitters
16. Place the events of signaling listed below in the CORRECT order.
1. G-protein binds to activated receptor forming a receptor–G-protein complex.
 2. Release of GDP by the G-protein.
 3. Change in conformation of the cytoplasmic loops of the receptor.
 4. Binding of GTP by the G-protein.
 5. Increase in the affinity of the receptor for a G-protein on the cytoplasmic surface of the membrane.
 6. Binding of a hormone or neurotransmitter to a G-protein–coupled receptor.
 7. Conformational shift in the α subunit of the G-protein.
- A. 6 – 3 – 5 – 1 – 2 – 4 – 7
 - B. 6 – 5 – 4 – 1 – 7 – 2 – 3
 - C. 6 – 3 – 5 – 1 – 7 – 2 – 4
 - D. 6 – 7 – 3 – 5 – 1 – 2 – 4
 - E. 6 – 3 – 5 – 4 – 7 – 2 – 1

17. Which heterotrimeric G-proteins couple receptors to adenylyl cyclase via the activation of GTP-bound G_{α} subunits?
- A. G_s family
 - B. G_q family
 - C. G_i family
 - D. $G_{12/13}$ family
 - E. G_x family
18. What must happen in order to prevent overstimulation by a hormone?
- A. Hormones must be degraded.
 - B. G-proteins must be recycled and then degraded.
 - C. Receptors must be blocked from continuing to activate G-proteins.
 - D. Receptors must dimerize.
19. Which of the following hormones termed the “flight-or-fight” hormone is secreted by the adrenal medulla?
- A. Epinephrine
 - B. Oxytocin
 - C. Insulin
 - D. Glucagon
 - E. Somatostatin
20. Which hormone is secreted by α cells in the pancreas in response to low blood glucose levels?
- A. Insulin
 - B. Glucagon
 - C. Estradiol
 - D. Epinephrine
 - E. Somatostatin
21. In liver cells, the expression of genes encoding gluconeogenic enzymes such as phosphoenolpyruvate carboxykinase is induced in response to which of the following molecules?
- A. cGMP
 - B. Insulin

- C. ATP
- D. cAMP
- E. Cholesterol

22. What happens to protein kinase A (PKA) following the binding of cAMP?
- A. The regulatory subunits of PKA dissociate, thereby activating the catalytic subunits.
 - B. PKA catalytic subunits then bind to two regulatory subunits, thereby activating the catalytic subunits.
 - C. The inhibitory regulatory subunits dissociate from the catalytic subunits, completely inactivating the enzyme.
 - D. The stimulatory regulatory subunits dissociate from the catalytic subunits, inhibiting the enzyme.
 - E. Phosphodiesterase binds to the catalytic subunits, which results in enzyme inactivation.

SECTION

IX

Special Topics (A)

CHAPTER

43

Nutrition, Digestion, & Absorption

David A. Bender, PhD & Peter A. Mayes, PhD, DSc

OBJECTIVES

After studying this chapter, you should be able to:

- Describe the digestion and absorption of carbohydrates, lipids, proteins, vitamins, and minerals.
- Explain how energy requirements can be measured and estimated, and how measuring the respiratory quotient permits estimation of the mix of metabolic fuels being oxidized.
- Describe the consequences of undernutrition: marasmus, cachexia, and kwashiorkor.
- Explain how protein requirements are determined and why more of some proteins than others are required to maintain nitrogen

balance.

BIOMEDICAL IMPORTANCE

In addition to water, the diet must provide metabolic fuels (mainly carbohydrates and lipids), protein (for growth and turnover of tissue proteins, as well as a source of metabolic fuel), fiber (for bulk in the intestinal lumen), minerals (containing elements with specific metabolic functions), and vitamins and essential fatty acids (organic compounds needed in smaller amounts for other metabolic and physiological functions). The polysaccharides, triacylglycerols, and proteins that make up the bulk of the diet must be hydrolyzed to their constituent monosaccharides, fatty acids, and amino acids, respectively, before absorption and utilization. Minerals and vitamins must be released from the complex matrix of food before they can be absorbed and utilized.

Globally, **undernutrition** is widespread, leading to impaired growth, defective immune system, and reduced work capacity. By contrast, in developed countries, and increasingly in developing countries, there is excessive food consumption, leading to obesity, and the development of diabetes, cardiovascular disease, and some cancers. Worldwide, there are more overweight and obese people than undernourished people. Deficiencies of vitamin A, iron, and iodine pose major health concerns in many countries, and deficiencies of other vitamins and minerals are a major cause of ill health. In developed countries nutrient deficiency is rare, although there are vulnerable sections of the population at risk. Intakes of minerals and vitamins that are adequate to prevent deficiency may be inadequate to promote optimum health and longevity.

Excessive secretion of gastric acid, associated with *Helicobacter pylori* infection, can result in the development of gastric and duodenal **ulcers**; small changes in the composition of bile can result in crystallization of cholesterol as **gallstones**; failure of exocrine pancreatic secretion (as in **cystic fibrosis**) leads to undernutrition and steatorrhea. **Lactose intolerance** is the result of lactase deficiency, leading to diarrhea and intestinal discomfort when lactose is consumed. Absorption of intact peptides that stimulate antibody responses causes **allergic reactions**; **celiac disease** is an allergic reaction to wheat gluten.

DIGESTION & ABSORPTION OF

CARBOHYDRATES

The digestion of carbohydrates is by hydrolysis to liberate oligosaccharides, then free mono- and disaccharides. The increase in blood glucose after a test dose of a carbohydrate compared with that after an equivalent amount of glucose (as glucose or from a reference starchy food) is known as the **glycemic index**. Glucose and galactose have an index of 1 (or 100%), as do lactose, maltose, isomaltose, and trehalose, which give rise to these monosaccharides on hydrolysis. Fructose and the sugar alcohols are absorbed less rapidly and have a lower glycemic index, as does sucrose. The glycemic index of starch varies between near 1 (or 100%) and near 0 as a result of variable rates of hydrolysis, and that of nonstarch polysaccharides (see [Figure 15–13](#)) is 0. Foods that have a low glycemic index are considered to be more beneficial since they cause less fluctuation in insulin secretion. Resistant starch and nonstarch polysaccharides provide substrates for bacterial fermentation in the large intestine, and the resultant butyrate and other short-chain fatty acids provide a significant source of fuel for intestinal enterocytes. There is evidence that butyrate also has antiproliferative activity, and so provides protection against colorectal cancer.

Amylases Catalyze the Hydrolysis of Starch

The hydrolysis of starch is catalyzed by salivary and pancreatic amylases, which catalyze random hydrolysis of $\alpha(1 \rightarrow 4)$ glycoside bonds, yielding dextrans, then a mixture of glucose, maltose, and maltotriose and small branched dextrans (from the branchpoints in amylopectin, [Figure 15–12](#)).

Disaccharidases Are Brush Border Enzymes

The disaccharidases, maltase, sucrase-isomaltase (a bifunctional enzyme catalyzing hydrolysis of sucrose and isomaltose), lactase, and trehalase are located on the brush border of the intestinal mucosal cells, where the resultant monosaccharides and those arising from the diet are absorbed. Congenital deficiency of lactase occurs rarely in infants, leading to lactose intolerance and failure to thrive when fed on breast milk or normal infant formula. Congenital deficiency of sucrase-isomaltase occurs among the Inuit, leading to sucrose intolerance, with persistent diarrhea and failure to thrive when the diet contains sucrose.

In most mammals, and most human beings, lactase activity begins to fall after weaning and is almost completely lost by late adolescence,

leading to **lactose intolerance**. Lactose remains in the intestinal lumen, where it is a substrate for bacterial fermentation to lactate, resulting in abdominal discomfort and diarrhea after consumption of relatively large amounts. In two population groups, people of north European origin and nomadic tribes of sub-Saharan Africa and Arabia, lactase persists after weaning and into adult life. Marine mammals secrete a high-fat milk that contains no carbohydrate, and their pups lack lactase.

There Are Two Separate Mechanisms for the Absorption of Monosaccharides in the Small Intestine

Glucose and galactose are absorbed by a sodium-dependent process. They are carried by the same transport protein (SGLT 1) and compete with each other for intestinal absorption (**Figure 43–1**). Other monosaccharides are absorbed by carrier-mediated diffusion. Because they are not actively transported, fructose and sugar alcohols are only absorbed down their concentration gradient, and after a moderately high intake, some may remain in the intestinal lumen, acting as a substrate for bacterial fermentation. Large intakes of fructose and sugar alcohols can lead to osmotic diarrhea.

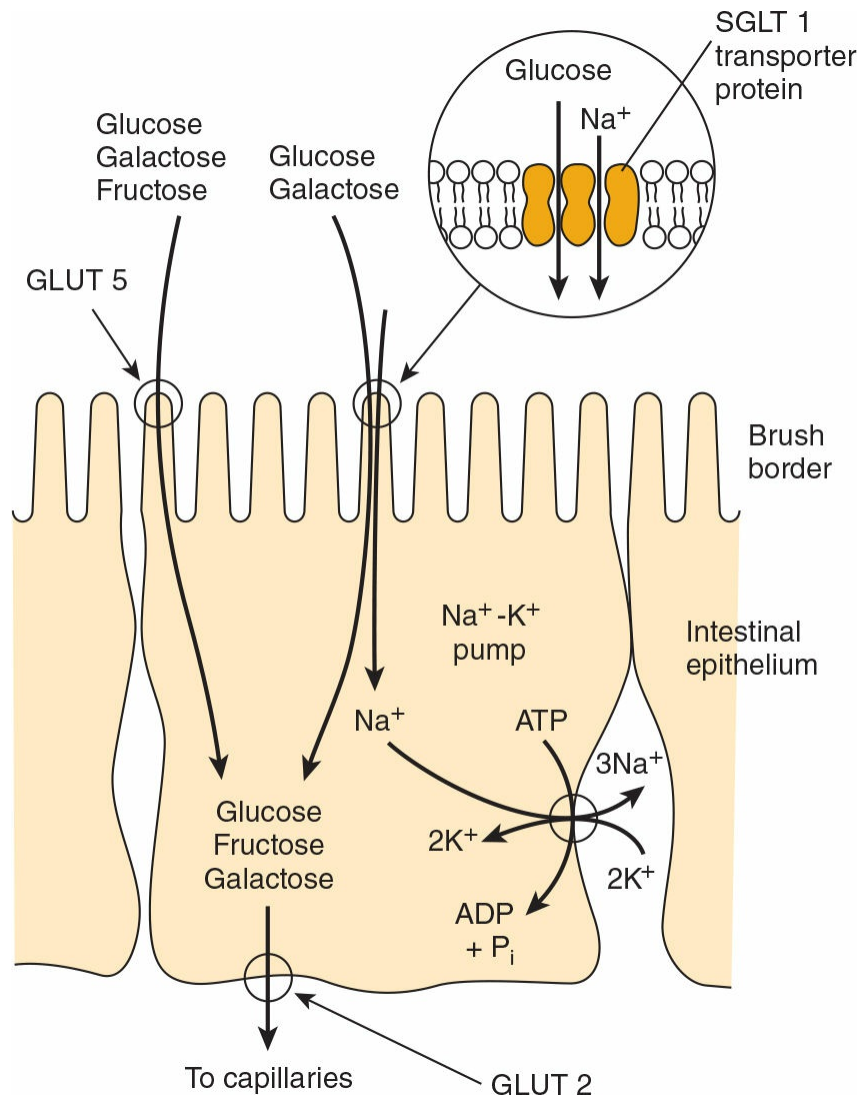

FIGURE 43–1 Transport of glucose, fructose, and galactose across the intestinal epithelium. The SGLT 1 transporter is coupled to the Na⁺-K⁺ pump, allowing glucose and galactose to be transported against their concentration gradients. The GLUT 5 Na⁺-independent facilitative transporter allows fructose, as well as glucose and galactose, to be transported down their concentration gradients. Exit from the cell for all sugars is via the GLUT 2 facilitative transporter.

DIGESTION & ABSORPTION OF LIPIDS

The major lipids in the diet are triacylglycerols and, to a lesser extent, phospholipids. These are hydrophobic molecules and have to be hydrolyzed and emulsified to very small droplets (micelles, 4-6 nm in diameter) before they can be absorbed. The fat-soluble vitamins, A, D, E, and K, and a variety of other lipids (including cholesterol and carotenes)

are absorbed dissolved in the lipid micelles. Absorption of carotenes and fat-soluble vitamins is impaired on a very low-fat diet.

Hydrolysis of triacylglycerols is initiated by lingual and gastric lipases, which attack the *sn*-3 ester bond forming 1,2-diacylglycerols and free fatty acids, which act as emulsifying agents. Pancreatic lipase is secreted into the small intestine and requires a further pancreatic protein, colipase, for activity. It is specific for the primary ester links—that is, positions 1 and 3 in triacylglycerols—resulting in 2-monoacylglycerols and free fatty acids as the major end products of luminal triacylglycerol digestion. Inhibitors of pancreatic lipase are used to inhibit triacylglycerol hydrolysis in the treatment of severe obesity. Pancreatic esterase in the intestinal lumen hydrolyzes monoacylglycerols, but they are poor substrates, and only ~25% of ingested triacylglycerol is completely hydrolyzed to glycerol and fatty acids before absorption (**Figure 43–2**). Bile salts, formed in the liver and secreted in the bile, permit emulsification of the products of lipid digestion into micelles together with dietary phospholipids and cholesterol secreted in the bile (about 2 g/d) as well as dietary cholesterol (about 0.5 g/d). Micelles are less than 1 μm in diameter, and soluble, so they allow the products of digestion, including the fat-soluble vitamins, to be transported through the aqueous environment of the intestinal lumen to come into close contact with the brush border of the mucosal cells, allowing uptake into the epithelium. The bile salts remain in the intestinal lumen, where most are absorbed from the ileum into the **enterohepatic circulation** (see **Chapter 26**).

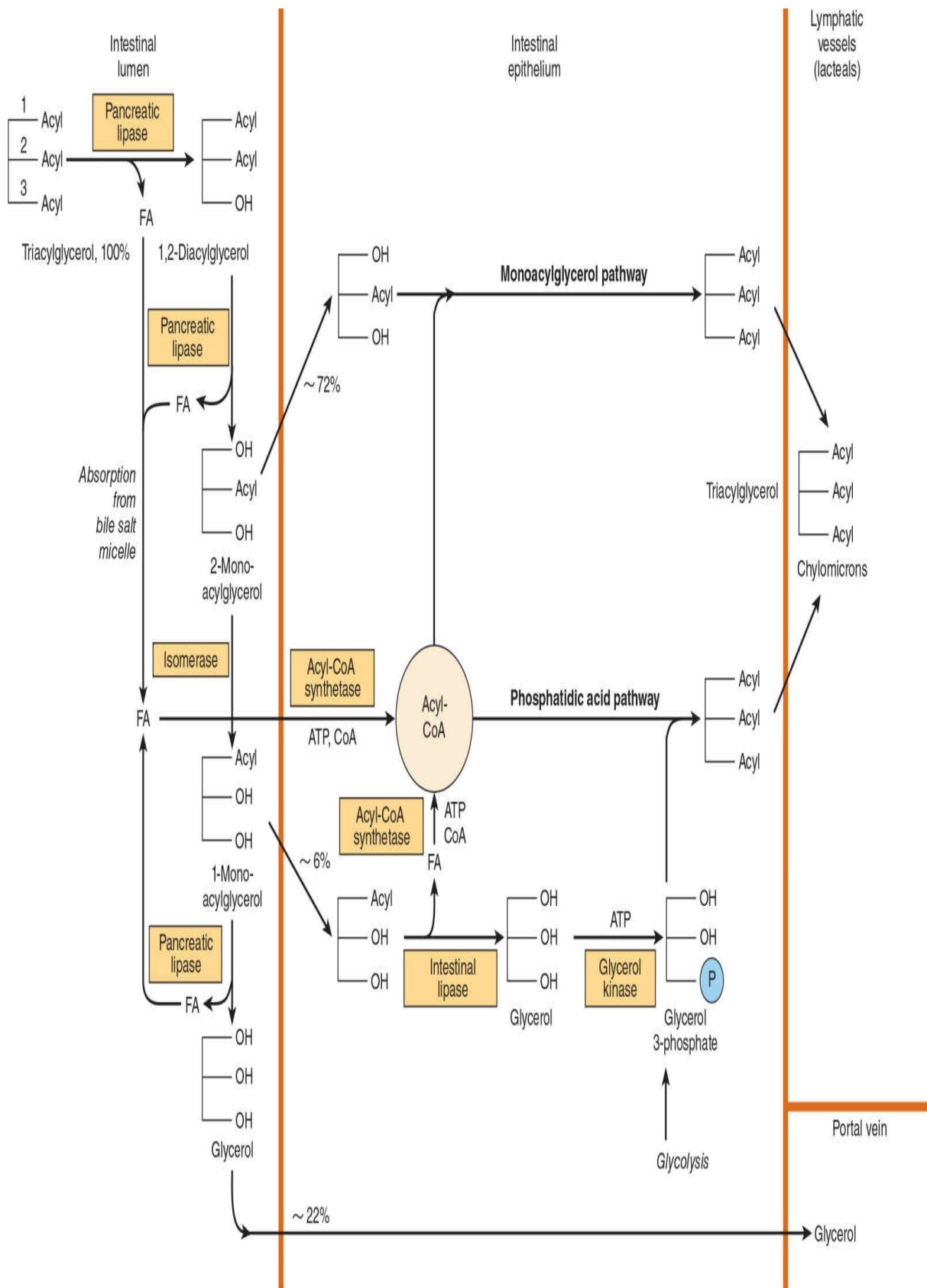

FIGURE 43–2 Digestion and absorption of triacylglycerols. The values given for percentage uptake may vary widely but indicate the relative importance of the three routes shown.

Within the intestinal epithelium, 1-monoacylglycerols are hydrolyzed to fatty acids and glycerol and 2-monoacylglycerols are reacylated to triacylglycerols via the **monoacylglycerol pathway**. Glycerol released in the intestinal lumen is absorbed into the hepatic portal vein; glycerol released within the epithelium is reutilized for triacylglycerol synthesis via the normal phosphatidic acid pathway (see [Chapter 24](#)). Long-chain fatty acids are esterified to triacylglycerol in the mucosal cells and together with the other products of lipid digestion, secreted as chylomicrons into the lymphatics, entering the bloodstream via the thoracic duct (see [Chapter 25](#)). Short- and medium-chain fatty acids are mainly absorbed into the hepatic portal vein as free fatty acids.

Cholesterol is absorbed dissolved in lipid micelles and is mainly esterified in the intestinal mucosa before being incorporated into chylomicrons. Plant sterols and stanols (in which the B ring is saturated) compete with cholesterol for esterification, but are poor substrates, so that there is an increased amount of unesterified cholesterol in the mucosal cells. Unesterified cholesterol and other sterols are actively transported out of the mucosal cells into the intestinal lumen. This means that plant sterols and stanols effectively inhibit the absorption of not only dietary cholesterol, but also the larger amount that is secreted in the bile, so lowering the whole body cholesterol content, and hence the plasma cholesterol concentration.

DIGESTION & ABSORPTION OF PROTEINS

Native proteins are resistant to digestion because few peptide bonds are accessible to the proteolytic enzymes without prior denaturation by heat in cooking and by the action of gastric acid.

Several Groups of Enzymes Catalyze the Digestion of Proteins

There are two main classes of proteolytic digestive enzymes (**proteases**), with different specificities for the amino acids forming the peptide bond to be hydrolyzed. **Endopeptidases** hydrolyze peptide bonds between specific amino acids throughout the molecule. They are the first enzymes to act, yielding a larger number of smaller fragments. Pepsin in the gastric juice catalyzes hydrolysis of peptide bonds adjacent to amino acids with bulky side-chains (aromatic and branched-chain amino acids and methionine). Trypsin, chymotrypsin, and elastase are secreted into the small intestine by

the pancreas. Trypsin catalyzes hydrolysis of lysine and arginine esters, chymotrypsin esters of aromatic amino acids, and elastase esters of small neutral aliphatic amino acids. **Exopeptidases** catalyze the hydrolysis of peptide bonds, one at a time, from the ends of peptides.

Carboxypeptidases, secreted in the pancreatic juice, release amino acids from the free carboxyl terminal; **aminopeptidases**, secreted by the intestinal mucosal cells, release amino acids from the amino terminal.

Dipeptidases and **tripeptidases** in the brush border of intestinal mucosal cells catalyze the hydrolysis of di- and tripeptides, which are not substrates for amino- and carboxypeptidases.

The proteases are secreted as inactive **zymogens**; the active site of the enzyme is masked by a small region of the peptide chain that is removed by hydrolysis of a specific peptide bond. Pepsinogen is activated to pepsin by gastric acid and by activated pepsin. In the small intestine, trypsinogen, the precursor of trypsin, is activated by enteropeptidase, which is secreted by the duodenal epithelial cells; trypsin can then activate chymotrypsinogen to chymotrypsin, proelastase to elastase, procarboxypeptidase to carboxypeptidase, and proaminopeptidase to aminopeptidase.

Free Amino Acids & Small Peptides Are Absorbed by Different Mechanisms

The end product of the action of endopeptidases and exopeptidases is a mixture of free amino acids, di- and tripeptides, and oligopeptides, all of which are absorbed. Free amino acids are absorbed across the intestinal mucosa by sodium-dependent active transport. There are several different amino acid transporters, with specificity for the nature of the amino acid side chain (large or small, neutral, acidic, or basic). The amino acids carried by any one transporter compete with each other for absorption and tissue uptake. Dipeptides and tripeptides enter the brush border of the intestinal mucosal cells, where they are hydrolyzed to free amino acids, which are then transported into the hepatic portal vein. Relatively large peptides may be absorbed intact, either by uptake into mucosal epithelial cells (transcellular) or by passing between epithelial cells (paracellular). Many such peptides are large enough to stimulate antibody formation—this is the basis of **allergic reactions** to foods.

DIGESTION & ABSORPTION OF VITAMINS &

MINERALS

Vitamins and minerals are released from food during digestion, although this is not complete, and the availability of vitamins and minerals depends on the type of food and, especially for minerals, the presence of chelating compounds. The fat-soluble vitamins are absorbed in the lipid micelles that are the result of fat digestion; water-soluble vitamins and most mineral salts are absorbed from the small intestine either by active transport or by carrier-mediated diffusion followed by binding to intracellular proteins to achieve concentrative uptake. Vitamin B₁₂ absorption requires a specific transport protein, intrinsic factor (see [Chapter 44](#)); calcium absorption is dependent on vitamin D; zinc absorption requires a zinc-binding ligand secreted by the exocrine pancreas, and the absorption of iron is limited (see below).

Calcium Absorption Is Dependent on Vitamin D

In addition to its role in regulating calcium homeostasis, vitamin D is required for the intestinal absorption of calcium. Synthesis of the intracellular calcium-binding protein, **calbindin**, required for calcium absorption, is induced by vitamin D. Vitamin D also acts to recruit calcium transporters to the cell surface, so increasing calcium absorption rapidly—a process that is independent of new protein synthesis.

Phytic acid (inositol hexaphosphate) in cereals binds calcium in the intestinal lumen, preventing its absorption. Other minerals, including zinc, are also chelated by phytate. This is mainly a problem among people who consume large amounts of unleavened whole-wheat products; yeast contains an enzyme, **phytase**, that dephosphorylates phytate, so rendering it inactive. High concentrations of fatty acids in the intestinal lumen, as a result of impaired fat absorption, can also reduce calcium absorption by forming insoluble calcium salts; a high intake of oxalate can sometimes cause deficiency since calcium oxalate is insoluble.

Iron Absorption Is Limited and Strictly Controlled, but Enhanced by Vitamin C and Alcohol

Although iron deficiency is a common problem in both developed and developing countries, about 10% of the population are genetically at risk of iron overload (**hemochromatosis**), and in order to reduce the risk of adverse effects of nonenzymic generation of free radicals by iron salts,

absorption is strictly regulated. Inorganic iron is transported into the mucosal cell by a proton-linked divalent metal ion transporter, and accumulated intracellularly by binding to **ferritin**. Iron leaves the mucosal cell via a transport protein ferroportin, but only if there is free **transferrin** in plasma to bind to. Once transferrin is saturated with iron, any that has accumulated in the mucosal cells is lost when the cells are shed. Expression of the ferroportin gene (and possibly also that for the divalent metal ion transporter) is downregulated by hepcidin, a peptide secreted by the liver when body iron reserves are adequate. In response to hypoxia, anemia, or hemorrhage, the synthesis of hepcidin is reduced, leading to increased synthesis of ferroportin and increased iron absorption (**Figure 43–3**). As a result of this mucosal barrier, only ~10% of dietary iron is absorbed, and only 1 to 5% from many plant foods.

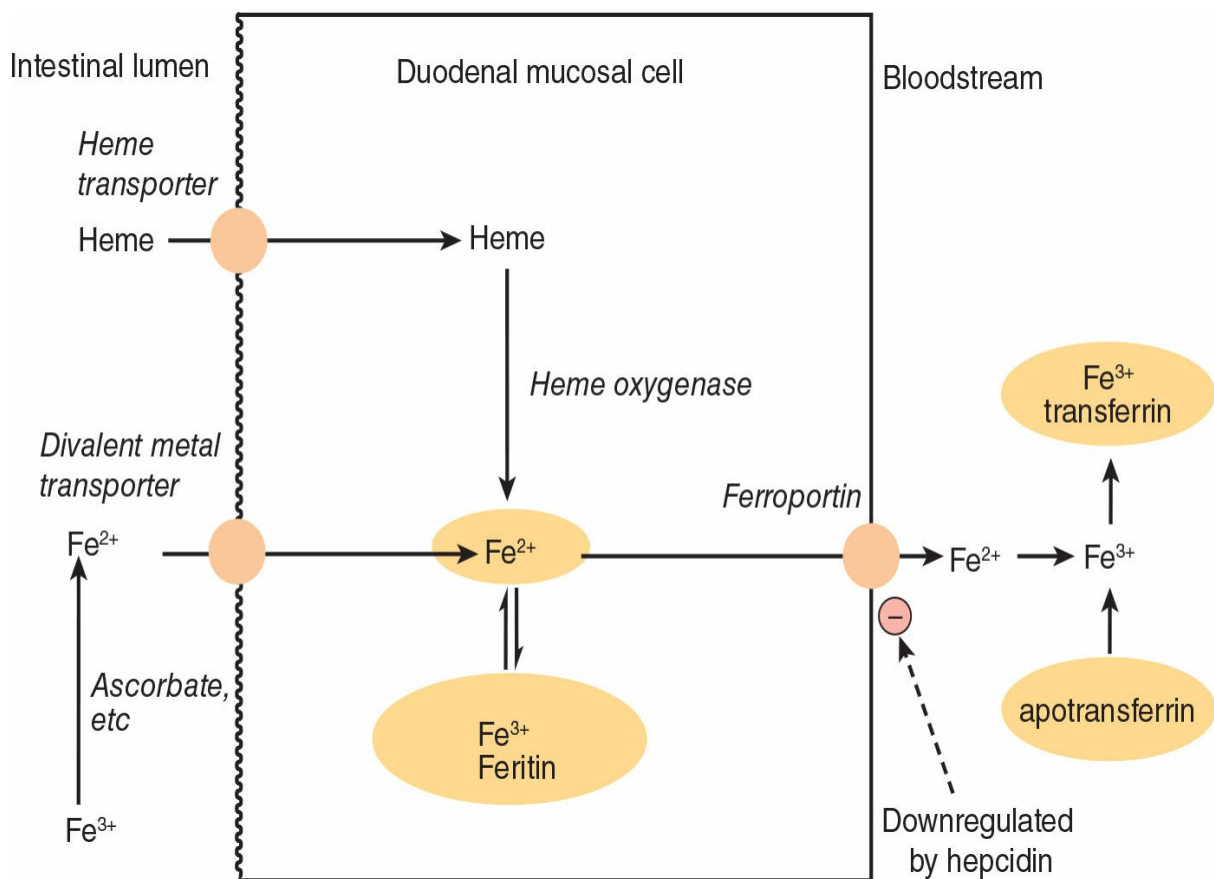

FIGURE 43–3 Absorption of iron. Hepcidin secreted by the liver downregulates synthesis of ferroportin and limits iron absorption.

Inorganic iron is absorbed in the Fe²⁺ (reduced) state, and hence, the presence of reducing agents enhances absorption. The most effective compound is **vitamin C**, and while intakes of 40 to 80 mg of vitamin C per

day are more than adequate to meet requirements, an intake of 25 to 50 mg per meal enhances iron absorption, especially when iron salts are used to treat iron deficiency anemia. Alcohol and fructose also enhance iron absorption. Heme iron from meat is absorbed separately and is considerably more available than inorganic iron. However, the absorption of both inorganic and heme iron is impaired by calcium—a glass of milk with a meal significantly reduces iron availability.

ENERGY BALANCE: OVER- & UNDERNUTRITION

After the provision of water, the body's first requirement is for metabolic fuels—fats, carbohydrates, and amino acids from proteins. Food intake in excess of energy expenditure leads to **obesity**, while intake less than expenditure leads to emaciation and wasting, **marasmus**, and **kwashiorkor**. Both obesity and severe undernutrition are associated with increased mortality. The body mass index = weight (in kg)/height² (in m) is commonly used as a way of expressing relative obesity; a desirable range is between 20 and 25.

Energy Requirements Are Estimated by Measurement of Energy Expenditure

Energy expenditure can be determined directly by measuring heat output from the body, but is normally estimated indirectly from the consumption of oxygen. There is an energy expenditure of ~20 kJ/L of oxygen consumed, regardless of whether the fuel being metabolized is carbohydrate, fat, or protein (see [Table 14–1](#)).

Measurement of the ratio of the volume of carbon dioxide produced: volume of oxygen consumed (**respiratory quotient [RQ]**) is an indication of the mixture of metabolic fuels being oxidized (see [Table 14–1](#)).

A more recent technique permits estimation of total energy expenditure over a period of 1 to 3 weeks, using dual isotopically labeled water, ²H₂¹⁸O. ²H is lost from the body only in water, while ¹⁸O is lost in both water and carbon dioxide; the difference in the rate of loss of the two labels permits estimation of total carbon dioxide production, and hence oxygen consumption and energy expenditure ([Figure 43–4](#)).

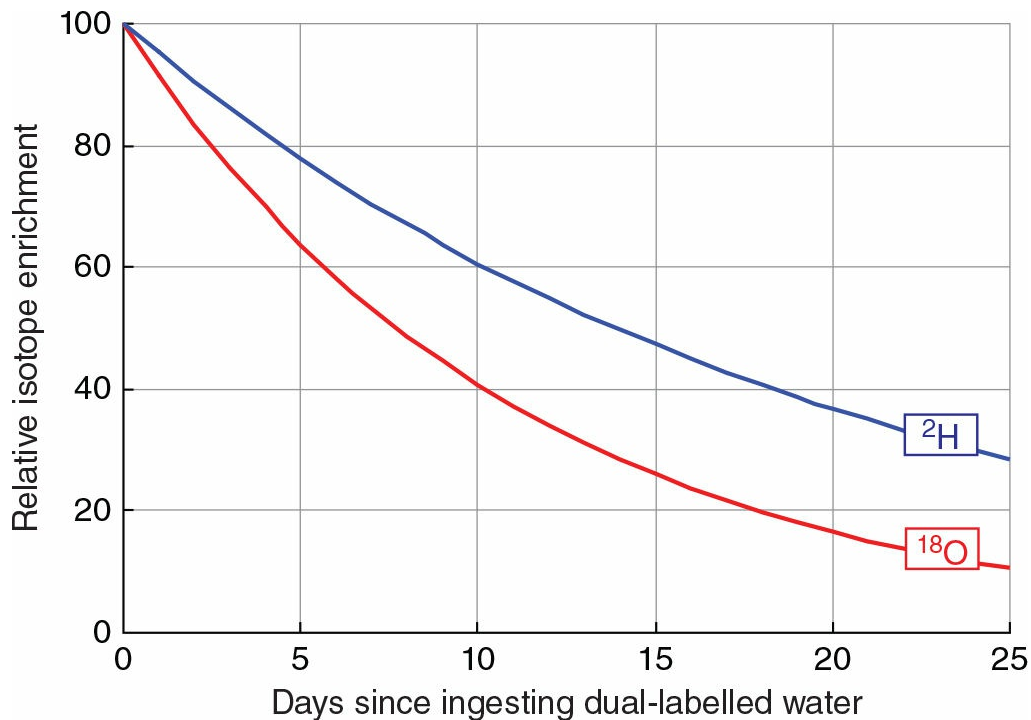

FIGURE 43–4 Dual isotopically labeled water for estimation of energy expenditure.

Basal metabolic rate (BMR) is the energy expenditure by the body when at rest, but not asleep, under controlled conditions of thermal neutrality, measured about 12 hours after the last meal, and depends on weight, age, and gender. **Total energy expenditure** depends on the BMR, the energy required for physical activity, and the energy cost of synthesizing reserves in the fed state. It is therefore possible to estimate an individual's energy requirement from body weight, age, gender, and level of physical activity. Body weight affects BMR because there is a greater amount of active tissue in a larger body. The decrease in BMR with increasing age, even when body weight remains constant, is the result of muscle tissue replacement by adipose tissue, which is metabolically less active. Similarly, women have a significantly lower BMR than do men of the same body weight and age because women's bodies contain proportionally more adipose tissue.

Energy Requirements Increase With Activity

The most useful way of expressing the energy cost of physical activities is as a multiple of BMR. This is known as the **physical activity ratio (PAR)** or **metabolic equivalent of the task (MET)**. Sedentary activities use only about 1.1 to 1.2 × BMR. By contrast, vigorous exertion, such as climbing

stairs, cross-country walking uphill, etc, may use 6 to $8 \times$ BMR. The overall **physical activity level (PAL)** is the sum of the PAR of different activities, multiplied by the time taken for that activity, divided by 24 hours.

Ten Percent of the Energy Yield of a Meal May Be Expended in Forming Reserves

There is a considerable increase in metabolic rate after a meal (**diet-induced thermogenesis**). A small part of this is the energy cost of secreting digestive enzymes and of active transport of the products of digestion; the major part is the energy cost of synthesizing reserves of glycogen, triacylglycerol, and protein.

There Are Two Extreme Forms of Undernutrition

Marasmus can occur in both adults and children and occurs in vulnerable groups of all populations. **Kwashiorkor** affects only children and has been reported only in developing countries. The distinguishing feature of kwashiorkor is that there is fluid retention, leading to edema, and fatty infiltration of the liver. Marasmus is a state of extreme emaciation; it is the outcome of prolonged negative energy balance. Not only have the body's fat reserves been exhausted, but there is wastage of muscle as well, and as the condition progresses, there is loss of protein from the heart, liver, and kidneys. The amino acids released by the catabolism of tissue proteins are used as a source of metabolic fuel and as substrates for gluconeogenesis to maintain a supply of glucose for the brain and red blood cells (see [Chapter 20](#)). As a result of the reduced synthesis of proteins, there is impaired immune response and increased risk of infection. Impairment of cell proliferation in the intestinal mucosa occurs, resulting in reduction in the surface area of the intestinal mucosa, and reduction in the absorption of such nutrients as are available.

Patients With Advanced Cancer and AIDS Are Malnourished

Patients with advanced cancer, HIV infection and AIDS, and a number of other chronic diseases are frequently undernourished, a condition called **cachexia**. Physically, they show all the signs of marasmus, but there is considerably more loss of body protein than occurs in starvation. Unlike

marasmus, where protein synthesis is reduced, but catabolism is unaffected, in cachexia the secretion of cytokines in response to infection and cancer increases the catabolism of tissue protein by the ATP-dependent ubiquitin-proteasome pathway, so increasing energy expenditure. Patients are **hypermetabolic**, that is, they have a considerably increased BMR. In addition to activation of the ubiquitin-proteasome pathway of protein catabolism, three other factors are involved. Many tumors metabolize glucose anaerobically to release lactate. This is then used for gluconeogenesis in the liver, which is energy consuming with a net cost of six ATP for each mol of glucose cycled (see [Figure 19–4](#)). There is increased stimulation of mitochondrial **uncoupling proteins** by **cytokines** leading to thermogenesis and increased oxidation of metabolic fuels. **Futile cycling of lipids** occurs because hormone-sensitive lipase is activated by a proteoglycan secreted by tumors, resulting in liberation of fatty acids from adipose tissue and ATP-expensive reesterification to triacylglycerols in the liver, which are exported in very-low-density lipoprotein (VLDL).

Kwashiorkor Affects Undernourished Children

In addition to the wasting of muscle tissue, loss of intestinal mucosa and impaired immune responses seen in marasmus, children with **kwashiorkor** show a number of characteristic features. The defining feature is **edema**, associated with a decreased concentration of plasma proteins. In addition, there is enlargement of the liver as a result of accumulation of fat. It was formerly believed that the cause of kwashiorkor was a lack of protein, with a more or less adequate energy intake; however, analysis of the diets of affected children shows that this is not so. Protein deficiency leads to stunting of growth, and children with kwashiorkor are less stunted than those with marasmus. Furthermore, the edema begins to improve early in treatment, when the child is still receiving a low-protein diet.

Very commonly, an infection precipitates kwashiorkor. Superimposed on general food deficiency, there is probably a deficiency of antioxidant nutrients such as zinc, copper, carotene, and vitamins C and E. The **respiratory burst** in response to infection leads to the production of oxygen and halogen **free radicals** as part of the cytotoxic action of stimulated macrophages. This added oxidant stress triggers the development of kwashiorkor.

PROTEIN & AMINO ACID REQUIREMENTS

Protein Requirements Can Be Determined by Measuring Nitrogen Balance

The state of protein nutrition can be determined by measuring the dietary intake and output of nitrogenous compounds from the body. Although nucleic acids also contain nitrogen, protein is the major dietary source of nitrogen and measurement of total nitrogen intake gives a good estimate of protein intake ($\text{mg N} \times 6.25 = \text{mg protein}$, as N is 16% of most proteins). The output of N from the body is mainly in urea and smaller quantities of other compounds in urine, undigested protein (including digestive enzymes and shed intestinal mucosal cells) in feces; significant amounts may also be lost in sweat and shed skin. The difference between intake and output of nitrogenous compounds is known as **nitrogen balance**. Three states can be defined. In a healthy adult, there is nitrogen **equilibrium**; intake equals output, and there is no change in the total body content of protein. In a growing child, a pregnant woman, or a person in recovery from protein loss, the excretion of nitrogenous compounds is less than the dietary intake and there is net retention of nitrogen in the body as protein—**positive nitrogen balance**. In response to trauma or infection, or if the intake of protein is inadequate to meet requirements, there is net loss of protein nitrogen from the body—**negative nitrogen balance**. Except when replacing protein losses, nitrogen equilibrium can be maintained at any level of protein intake above requirements. A high intake of protein does not lead to positive nitrogen balance; although it increases the rate of protein synthesis, it also increases the rate of protein catabolism, so that nitrogen equilibrium is maintained, albeit with a higher rate of protein turnover. Both protein synthesis and catabolism are ATP expensive, and this increased rate of protein turnover explains the increased diet-induced thermogenesis seen in people consuming a high-protein diet.

The continual catabolism of tissue proteins creates the requirement for dietary protein, even in an adult who is not growing; although some of the amino acids released can be reutilized, much is used for gluconeogenesis in the fasting state. Nitrogen balance studies show that the average daily requirement is 0.66 g of protein per kg body weight (giving a reference intake of 0.825 g of protein/kg body weight, allowing for individual variation); ~55 g/d, or 8 to 9% of energy intake. Average intakes of protein in developed countries are of the order of 80 to 100 g/d, that is, 14 to 15% of energy intake. Because growing children are increasing the protein in the body, they have a proportionally greater requirement than adults and should be in positive nitrogen balance. Even so, the need is relatively small

compared with the requirement for protein turnover. In some countries, protein intake is inadequate to meet these requirements, resulting in stunting of growth. There is little or no evidence that athletes and body builders require large amounts of protein; simply consuming more of a normal diet providing about 14% of energy from protein will provide more than enough protein for increased muscle protein synthesis—the main requirement is for an increased energy intake to permit increased protein synthesis.

There Is a Loss of Body Protein in Response to Trauma & Infection

One of the metabolic reactions to a major trauma, such as a burn, a broken limb, or surgery, is an increase in the net catabolism of tissue proteins, both in response to cytokines and glucocorticoid hormones, and as a result of excessive utilization of threonine and cysteine in the synthesis of **acute-phase proteins**. As much as 6 to 7% of the total body protein may be lost over 10 days. Prolonged bed rest results in considerable loss of protein because of atrophy of muscles. Protein catabolism may be increased in response to cytokines, and without the stimulus of exercise it is not completely replaced. Lost protein is replaced during **convalescence**, when there is positive nitrogen balance. Again, as in the case of athletes, a normal diet is adequate to permit this replacement protein synthesis.

The Requirement Is Not Just for Protein, but for Specific Amino Acids

Not all proteins are nutritionally equivalent. More of some is needed to maintain nitrogen balance than others because different proteins contain different amounts of the various amino acids. The body's requirement is for amino acids in the correct proportions to replace tissue proteins. The amino acids can be divided into two groups: **essential** and **nonessential**. There are nine essential or indispensable amino acids, which cannot be synthesized in the body: histidine, isoleucine, leucine, lysine, methionine, phenylalanine, threonine, tryptophan, and valine. If one of these is lacking or inadequate, then regardless of the total intake of protein, it will not be possible to maintain nitrogen balance since there will not be enough of that amino acid for protein synthesis.

Two amino acids, cysteine and tyrosine, can be synthesized in the body, but only from essential amino acid precursors—cysteine from methionine

and tyrosine from phenylalanine. The dietary intakes of cysteine and tyrosine thus affect the requirements for methionine and phenylalanine. The remaining 11 amino acids in proteins are considered to be nonessential or dispensable since they can be synthesized as long as there is enough total protein in the diet. If one of these amino acids is omitted from the diet, nitrogen balance can still be maintained. However, only three amino acids, alanine, aspartate, and glutamate, can be considered to be truly dispensable; they are synthesized by transamination of common metabolic intermediates (pyruvate, oxaloacetate, and ketoglutarate, respectively). The remaining amino acids are considered as nonessential, but under some circumstances the requirement may outstrip the capacity for their synthesis.

SUMMARY

- Digestion involves hydrolyzing food molecules into smaller molecules for absorption through the gastrointestinal epithelium. Polysaccharides are absorbed as monosaccharides, triacylglycerols as 2-monoacylglycerols, fatty acids and glycerol, and proteins as amino acids and small peptides.
- Digestive disorders arise as a result of (1) enzyme deficiency, for example, lactase and sucrase; (2) malabsorption, for example, of glucose and galactose as a result of defects in the Na⁺-glucose cotransporter (SGLT 1); (3) absorption of unhydrolyzed polypeptides leading to immune responses, for example, as in celiac disease; and (4) precipitation of cholesterol from bile as gallstones.
- In addition to water, the diet must provide metabolic fuels (carbohydrate and fat) for body growth and activity, protein for synthesis of tissue proteins, fiber for bulk in the intestinal contents, minerals for specific metabolic functions (see [Chapter 44](#)), polyunsaturated fatty acids of the *n*-3 and *n*-6 families, and vitamins—organic compounds needed in small amounts for other essential functions (see [Chapter 44](#)).
- Undernutrition occurs in two extreme forms: marasmus, in adults and children, and kwashiorkor in children. Chronic illness can also lead to undernutrition (cachexia) as a result of hypermetabolism.
- Overnutrition leads to excess energy intake and is associated with chronic noncommunicable diseases such as obesity, type 2 diabetes, atherosclerosis, cancer, and hypertension.
- Twenty different amino acids are required for protein synthesis, of

which nine are essential in the human diet. The quantity of protein required can be determined by studies of nitrogen balance and is affected by protein quality—the amounts of essential amino acids present in dietary proteins compared with the amounts required for tissue protein synthesis.

Micronutrients: Vitamins & Minerals

David A. Bender, PhD

OBJECTIVES

After studying this chapter, you should be able to:

- Describe how reference intakes for vitamins and minerals are determined and explain why reference intakes published by different national and international authorities differ.
- Define a vitamin and describe the metabolism, principal functions, deficiency diseases associated with inadequate intake, and the toxicity of excessive intakes of the vitamins.
- Explain why mineral salts are required in the diet.

BIOMEDICAL IMPORTANCE

Vitamins are a group of organic nutrients, required in small quantities for a variety of biochemical functions that, generally, cannot be synthesized by the body and must therefore be supplied in the diet.

The lipid-soluble vitamins are hydrophobic compounds that can be

absorbed efficiently only when there is normal fat absorption. Like other lipids, they are transported in the blood in lipoproteins or attached to specific binding proteins. They have diverse functions—for example, vitamin A, vision and cell differentiation; vitamin D, calcium and phosphate metabolism, and cell differentiation; vitamin E, antioxidant; and vitamin K, blood clotting. As well as dietary inadequacy, conditions affecting the digestion and absorption of the lipid-soluble vitamins, such as a very-low-fat diet, steatorrhea, and disorders of the biliary system, can all lead to deficiency syndromes, including night blindness and xerophthalmia (vitamin A); rickets in young children and osteomalacia in adults (vitamin D); neurologic disorders and hemolytic anemia of the newborn (vitamin E); and hemorrhagic disease of the newborn (vitamin K). Toxicity can result from excessive intake of vitamins A and D. Vitamin A and the carotenes (many of which are precursors of vitamin A), and vitamin E are antioxidants (see [Chapter 45](#)) and have possible roles in prevention of atherosclerosis and cancer, although in excess they may also act as damaging pro-oxidants.

The water-soluble vitamins are vitamins B and C, folic acid, biotin, and pantothenic acid; they function mainly as enzyme cofactors. Folic acid acts as a carrier of one-carbon units. Deficiency of a single vitamin of the B complex is rare since poor diets are most often associated with **multiple deficiency states**. Nevertheless, specific syndromes are characteristic of deficiencies of individual vitamins, for example, beriberi (thiamin); cheilosis, glossitis, seborrhea (riboflavin); pellagra (niacin); megaloblastic anemia, methylmalonic aciduria, and pernicious anemia (vitamin B₁₂); megaloblastic anemia (folic acid); and scurvy (vitamin C).

Inorganic mineral elements that have a function in the body must be provided in the diet. When the intake is insufficient, deficiency signs may arise, for example, anemia (iron), and cretinism and goiter (iodine). Excessive intakes may be toxic.

The Determination of Micronutrient Requirements Depends on the Criteria of Adequacy Chosen

For any nutrient, there is a range of intakes between that which is clearly inadequate, leading to **clinical deficiency disease**, and that which is so much in excess of the body's metabolic capacity that there may be signs of **toxicity**. Between these two extremes is a level of intake that is adequate for normal health and the maintenance of metabolic integrity. Requirements are determined in depletion/repletion studies, in which

people are deprived of the nutrient until there is a metabolic change, then repleted with the nutrient until the abnormality is normalized. Individuals do not all have the same requirement for nutrients, even when calculated on the basis of body size or energy expenditure. There is a range of individual requirements of up to 25% around the mean. Therefore, in order to assess the adequacy of diets, it is necessary to set a reference level of intake high enough to ensure that no one either suffers from deficiency or is at risk of toxicity. If it is assumed that individual requirements are distributed in a statistically normal fashion around the observed mean requirement, then a range of $\pm 2 \times$ the standard deviation (SD) around the mean includes the requirements of 95% of the population. Reference or recommended intakes are therefore set at the average requirement plus $2 \times$ SD, and so meet or exceed the requirements of 97.5% of the population.

Reference and recommended intakes of vitamins and minerals published by different national and international authorities differ because of different interpretations of the available data, and the availability of new experimental data in more recent publications.

THE VITAMINS ARE A DISPARATE GROUP OF COMPOUNDS WITH A VARIETY OF METABOLIC FUNCTIONS

A vitamin is defined as an organic compound that is required in the diet in small amounts for the maintenance of normal metabolic integrity. Deficiency causes a specific disease, which is cured or prevented only by restoring the vitamin to the diet (**Table 44–1**). However, **vitamin D**, which is formed in the skin from 7-dehydrocholesterol on exposure to sunlight, and **niacin**, which can be formed from the essential amino acid tryptophan, do not strictly comply with this definition.

TABLE 44–1 The Vitamins

Vitamin		Functions	Deficiency Disease
Lipid-soluble			
A	Retinol, β -carotene	Visual pigments in the retina; regulation of gene expression and cell differentiation (β -carotene is an antioxidant)	Night blindness, xerophthalmia; keratinization of skin
D	Calciferol	Maintenance of calcium balance; enhances intestinal absorption of Ca^{2+} and mobilizes bone mineral; regulation of gene expression and cell differentiation	Rickets = poor mineralization of bone in children; osteomalacia = bone demineralization in adults
E	Tocopherols, tocotrienols	Antioxidant, especially in cell membranes; roles in cell signaling	Extremely rare—serious neurologic dysfunction
K	Phylloquinone: menaquinones	Coenzyme in formation of γ -carboxyglutamate in enzymes of blood clotting and bone matrix	Impaired blood clotting, hemorrhagic disease
Water-soluble			
B_1	Thiamin	Coenzyme in pyruvate and α -ketoglutarate dehydrogenases, and transketolase; regulates Cl^- channel in nerve conduction	Peripheral nerve damage (beriberi) or central nervous system lesions (Wernicke-Korsakoff syndrome)
B_2	Riboflavin	Coenzyme in oxidation and reduction reactions (FAD and FMN); prosthetic group of flavoproteins	Lesions of corner of mouth, lips, and tongue, seborrheic dermatitis
Niacin	Nicotinic acid, nicotinamide	Coenzyme in oxidation and reduction reactions, functional part of NAD and NADP; role in intracellular calcium regulation and cell signaling	Pellagra—photosensitive dermatitis, depressive psychosis
B_6	Pyridoxine, pyridoxal, pyridoxamine	Coenzyme in transamination and decarboxylation of amino acids and glycogen phosphorylase; modulation of steroid hormone action	Disorders of amino acid metabolism, convulsions
	Folic acid	Coenzyme in transfer of one-carbon fragments	Megaloblastic anemia
B_{12}	Cobalamin	Coenzyme in transfer of one-carbon fragments and metabolism of folic acid	Pernicious anemia = megaloblastic anemia with degeneration of the spinal cord
	Pantothenic acid	Functional part of CoA and acyl carrier protein; fatty acid synthesis and metabolism	Peripheral nerve damage (nutritional melalgia or "burning foot syndrome")
H	Biotin	Coenzyme in carboxylation reactions in gluconeogenesis and fatty acid synthesis; role in regulation of cell cycle	Impaired fat and carbohydrate metabolism, dermatitis
C	Ascorbic acid	Coenzyme in hydroxylation of proline and lysine in collagen synthesis; antioxidant; enhances absorption of iron	Scurvy—impaired wound healing, loss of dental cement, subcutaneous hemorrhage

LIPID-SOLUBLE VITAMINS

TWO GROUPS OF COMPOUNDS HAVE VITAMIN A ACTIVITY

Retinoids comprise **retinol**, **retinaldehyde**, and **retinoic acid** (preformed vitamin A, found only in foods of animal origin); carotenoids, found in plants, are a variety of carotenes and related compounds; many are precursors of vitamin A, as they can be cleaved to yield retinaldehyde, then retinol and retinoic acid (**Figure 44–1**). The α -, β -, and γ -carotenes and cryptoxanthin are quantitatively the most important provitamin A carotenoids. β -Carotene and other provitamin A carotenoids are cleaved in the intestinal mucosa by carotene dioxygenase, yielding retinaldehyde, which is reduced to retinol, esterified and secreted in chylomicrons together with esters formed from dietary retinol. The intestinal activity of carotene dioxygenase is low, so that a relatively large proportion of ingested β -carotene may appear in the circulation unchanged. There are two isoenzymes of carotene dioxygenase. One catalyzes cleavage of the central bond of β -carotene; the other catalyzes asymmetric cleavage leading to the formation of 8'-, 10'-, and 12'-apo-carotenals, which are oxidized to retinoic acid, but cannot be used as sources of retinol or retinaldehyde.

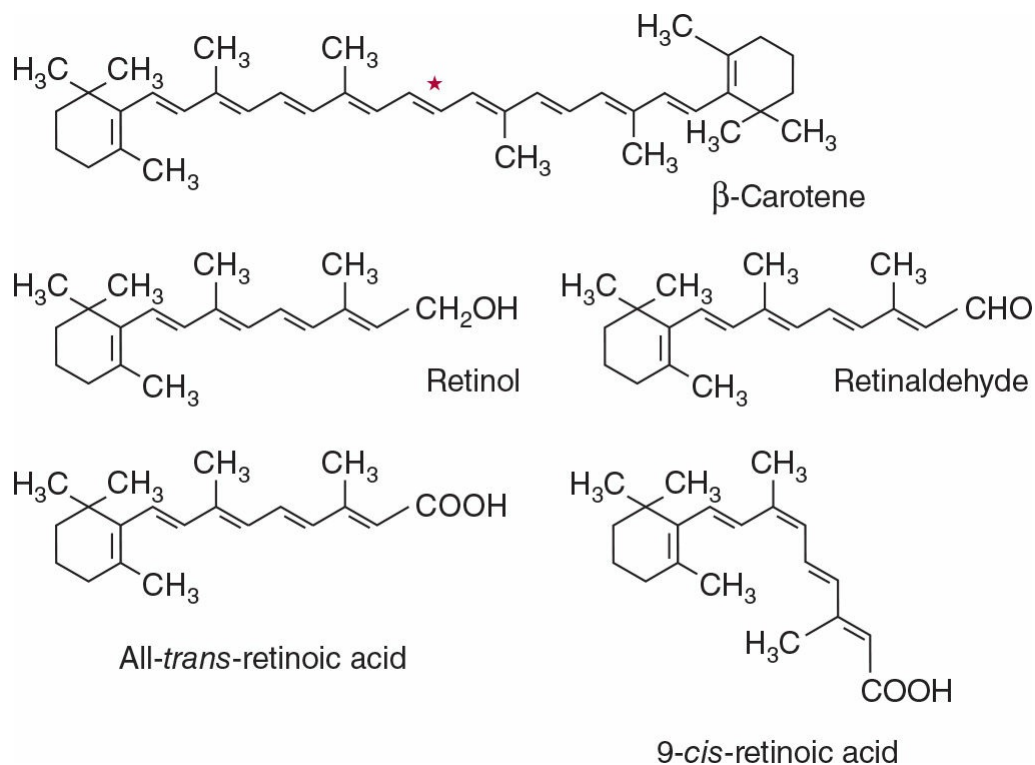

FIGURE 44–1 β -Carotene and the major vitamin A vitamers. Asterisk shows the site of symmetrical cleavage of β -carotene by carotene dioxygenase, to yield retinaldehyde.

Although it would appear that one molecule of β -carotene should yield two of retinol, this is not so in practice; 6 μg of β -carotene is equivalent to 1 μg of preformed retinol. The total amount of vitamin A in foods is therefore expressed as micrograms of retinol equivalents = μg preformed vitamin A + $1/6 \times \mu\text{g}$ β -carotene + $1/12 \times \mu\text{g}$ other provitamin A carotenoids. Before pure vitamin A was available for chemical analysis, the vitamin A content of foods was determined by biological assay and the results expressed as international units (IU). 1 IU = 0.3 μg retinol; 1 μg retinol = 3.33 IU. Although obsolete, IU is sometimes still used in food labeling. The term **retinol activity equivalent** takes account of the incomplete absorption and metabolism of carotenoids; 1 RAE = 1 μg all-*trans*-retinol, 12 μg β -carotene, 24 μg α -carotene or β -cryptoxanthin. On this basis, 1 IU of vitamin A activity is equal to 3.6 μg β -carotene or 7.2 μg of other provitamin A carotenoids.

Vitamin A Has a Function in Vision

In the retina, retinaldehyde functions as the prosthetic group of the light-sensitive opsin proteins, forming **rhodopsin** (in rods) and **iodopsin** (in cones). Any one cone cell contains only one type of opsin and is sensitive to only one color. In the pigment epithelium of the retina, all-*trans*-retinol is isomerized to 11-*cis*-retinol and oxidized to 11-*cis*-retinaldehyde. This reacts with a lysine residue in opsin, forming the holoprotein rhodopsin. As shown in **Figure 44–2**, the absorption of light by rhodopsin causes isomerization of the retinaldehyde from 11-*cis* to all-*trans*, and a conformational change in opsin. This results in the release of retinaldehyde from the protein, and the initiation of a nerve impulse. The formation of the initial excited form of rhodopsin, bathorhodopsin, occurs within picoseconds of illumination. There is then a series of conformational changes leading to the formation of metarhodopsin II, which initiates a guanine nucleotide amplification cascade and then a nerve impulse. The final step is hydrolysis to release all-*trans*-retinaldehyde and opsin. The key to initiation of the visual cycle is the availability of 11-*cis*-retinaldehyde, and hence vitamin A. In deficiency, both the time taken to adapt to darkness and the ability to see in poor light are impaired.

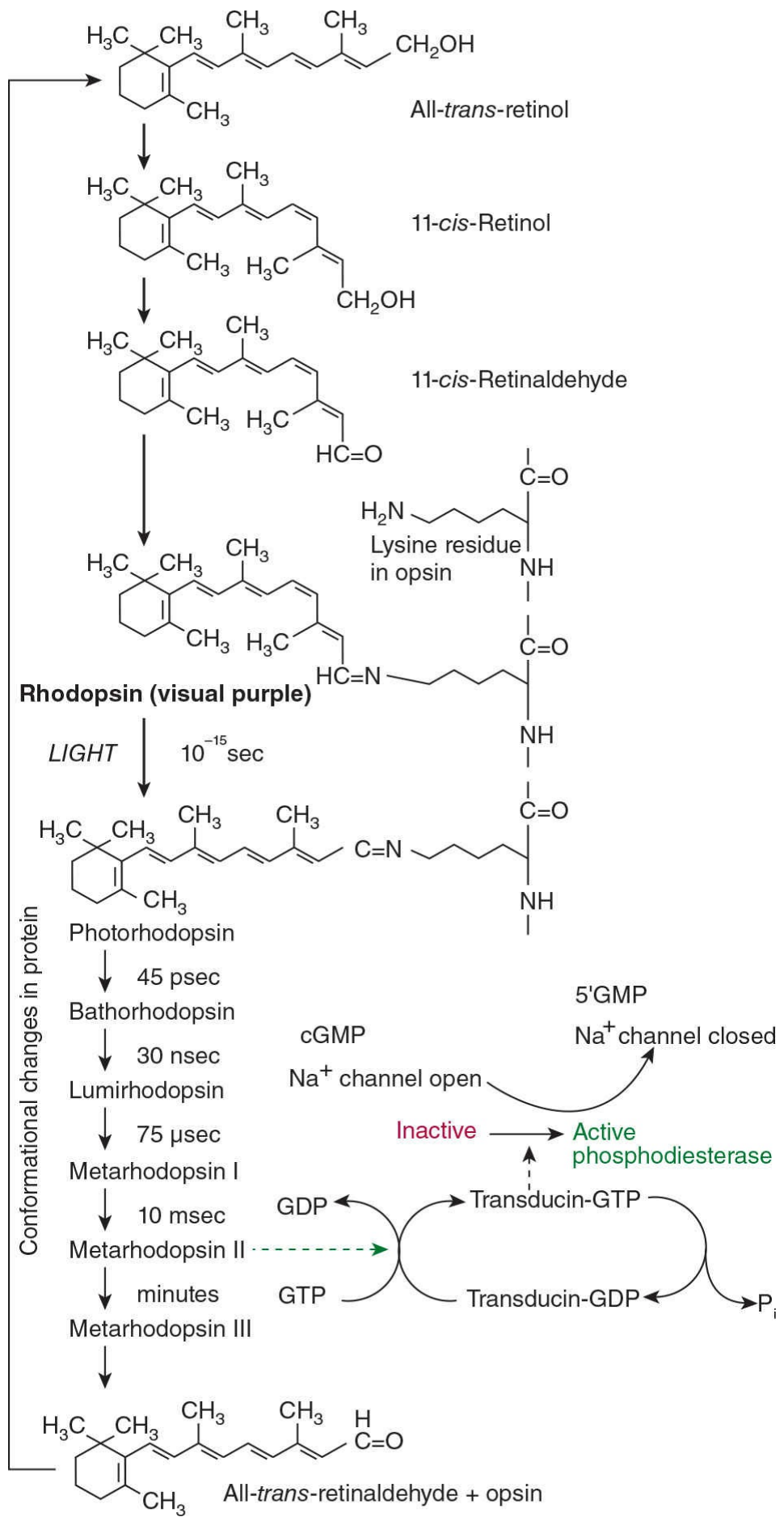

FIGURE 44–2 The role of retinaldehyde in the visual cycle.

Retinoic Acid Has a Role in the Regulation of Gene Expression and Tissue Differentiation

A major role of vitamin A is in the control of cell differentiation and turnover. All-*trans*-retinoic acid and 9-*cis*-retinoic acid (Figure 44–1) regulate growth, development, and tissue differentiation; they have different actions in different tissues. Like the thyroid and steroid hormones and vitamin D, retinoic acid binds to nuclear receptors that bind to response elements of DNA and regulate the transcription of specific genes. There are two families of nuclear retinoid receptors: the retinoic acid receptors (RAR) bind all-*trans*-retinoic acid or 9-*cis*-retinoic acid, and the retinoid X receptors (RXR) bind 9-*cis*-retinoic acid. RXRs also form dimers with vitamin D, thyroid, and other nuclear acting hormone receptors. Deficiency of vitamin A impairs vitamin D and thyroid hormone function because of lack of 9-*cis*-retinoic acid to form active receptor dimers. Unoccupied RXRs form dimers with occupied vitamin D and thyroid hormone receptors, but not only do these not activate gene expression, they may repress it, so that vitamin A deficiency has a more severe effect on vitamin D and thyroid hormone function than simply failure to activate gene expression. Excessive vitamin A also impairs vitamin D and thyroid hormone function, because of formation of RXR homodimers, meaning that there are not enough RXR available to form heterodimers with the vitamin D and thyroid hormone receptors.

Vitamin A Deficiency Is a Major Public Health Problem Worldwide

Vitamin A deficiency is the most important preventable cause of blindness. The earliest sign of deficiency is a loss of sensitivity to green light, followed by impairment to adapt to dim light, then night blindness, an inability to see in the dark. More prolonged deficiency leads to **xerophthalmia**: keratinization of the cornea, and blindness. Vitamin A also has an important role in differentiation of immune system cells, and even mild deficiency leads to increased susceptibility to infectious diseases. The synthesis of retinol-binding protein, which is required to transport the vitamin in the bloodstream, is reduced in response to infection (it is a negative **acute phase protein**), decreasing the circulating

concentration of the vitamin, and further impairing immune responses.

Vitamin A Is Toxic in Excess

There is only a limited capacity to metabolize vitamin A, and excessive intakes lead to accumulation beyond the capacity of intracellular binding proteins; unbound vitamin A causes membrane lysis and tissue damage. Symptoms of toxicity affect the central nervous system (headache, nausea, ataxia, and anorexia, all associated with increased cerebrospinal fluid pressure); the liver (hepatomegaly with histological changes and hyperlipidemia); calcium homeostasis (thickening of the long bones, hypercalcemia, and calcification of soft tissues); and the skin (excessive dryness, desquamation, and alopecia).

VITAMIN D IS REALLY A HORMONE

Vitamin D is not strictly a vitamin since it can be synthesized in the skin, and under most conditions this is the major source of the vitamin. Only when sunlight exposure is inadequate is a dietary source required. Its main function is in the regulation of calcium absorption and homeostasis; most of its actions are mediated by way of nuclear receptors that regulate gene expression. It also has a role in regulating cell proliferation and differentiation. There is evidence that intakes considerably higher than are required to maintain calcium homeostasis reduce the risk of insulin resistance, obesity, and the metabolic syndrome, as well as various cancers. Deficiency, leading to rickets in children and osteomalacia in adults, continues to be a problem in northern latitudes, where sunlight exposure is inadequate.

Vitamin D Is Synthesized in the Skin

7-Dehydrocholesterol (an intermediate in the synthesis of cholesterol that accumulates in the skin) undergoes a nonenzymic reaction on exposure to ultraviolet light, yielding previtamin D (**Figure 44–3**). This undergoes a further reaction over a period of hours to form cholecalciferol, which is absorbed into the bloodstream. In temperate climates, the plasma concentration of vitamin D is highest at the end of summer and lowest at the end of winter. Beyond latitudes about 40° north or south, there is very little ultraviolet radiation of the appropriate wavelength in winter.

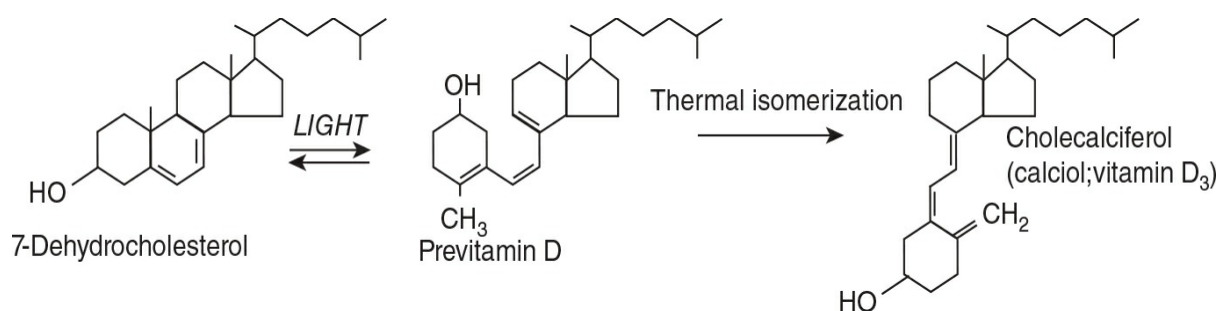

FIGURE 44–3 The synthesis of vitamin D in the skin.

Vitamin D Is Metabolized to the Active Metabolite, Calcitriol, in Liver & Kidney

Cholecalciferol, either synthesized in the skin or from food, undergoes two hydroxylations to yield the active metabolite, 1,25-dihydroxyvitamin D or calcitriol (**Figure 44–4**). Ergocalciferol from fortified foods undergoes similar hydroxylation to yield ercalcitriol. In the liver, cholecalciferol is hydroxylated to form the 25-hydroxy derivative, calcidiol. This is released into the circulation bound to a vitamin D–binding globulin, which is the main storage form of the vitamin. In the kidney, calcidiol undergoes either 1-hydroxylation to yield the active metabolite 1,25-dihydroxyvitamin D (calcitriol), or 24-hydroxylation to yield a probably inactive metabolite, 24,25-dihydroxyvitamin D (24-hydroxycalcidiol). Some tissues, other than those that are involved in calcium homeostasis, take up calcidiol from the circulation and synthesize calcitriol that acts within that cell.

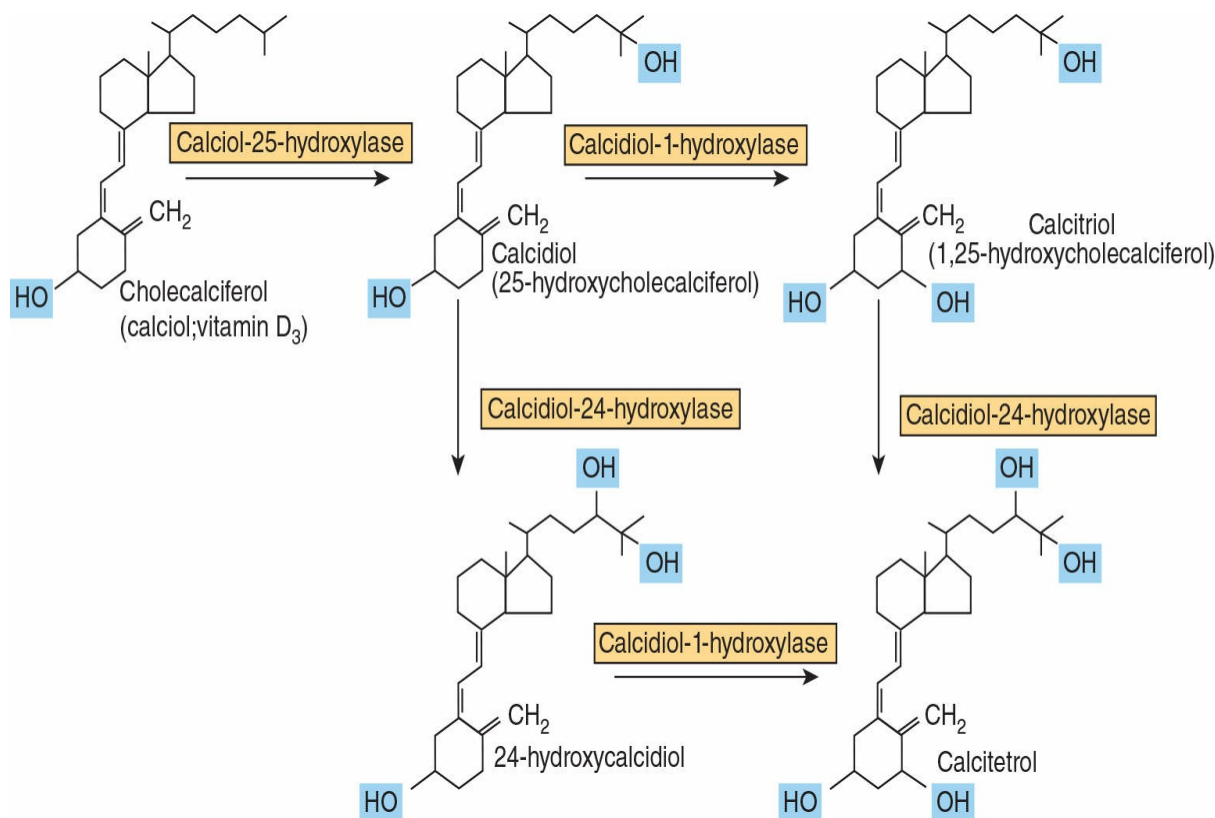

FIGURE 44–4 Metabolism of vitamin D.

Vitamin D Metabolism Is Both Regulated by and Regulates Calcium Homeostasis

The main function of vitamin D is in the control of calcium homeostasis, and in turn, vitamin D metabolism is regulated by factors that respond to plasma concentrations of calcium and phosphate. Calcitriol acts to reduce its own synthesis by inducing the 24-hydroxylase and repressing the 1-hydroxylase in the kidney. The principal function of vitamin D is to maintain the plasma calcium concentration. Calcitriol achieves this in three ways: it increases intestinal absorption of calcium; it reduces excretion of calcium (by stimulating reabsorption in the distal renal tubules); and it mobilizes bone mineral. In addition, calcitriol is involved in insulin secretion, synthesis and secretion of parathyroid and thyroid hormones, inhibition of production of interleukin by activated T-lymphocytes and of immunoglobulin by activated B-lymphocytes, differentiation of monocyte precursor cells, and modulation of cell proliferation. In most of these actions, it acts like a steroid hormone, binding to nuclear receptors and enhancing gene expression, although it also has a rapid effect to mobilize calcium transporters in the intestinal mucosa.

Higher Intakes of Vitamin D May Be Beneficial

There is growing evidence that higher vitamin D status is protective against various cancers, including prostate and colorectal cancer, and also against prediabetes and the metabolic syndrome. Desirable levels of intake may be considerably higher than current reference intakes, and certainly could not be met from unfortified foods. While increased sunlight exposure would meet the need, it carries the risk of developing skin cancer.

Vitamin D Deficiency Affects Children & Adults

In the vitamin D deficiency disease **rickets**, the bones of children are undermineralized as a result of poor absorption of calcium. Similar problems occur as a result of deficiency during the adolescent growth spurt. **Osteomalacia** in adults results from the demineralization of bone, especially in women who have little exposure to sunlight, especially after several pregnancies. Although vitamin D is essential for prevention and treatment of osteomalacia in the elderly, there is less evidence that it is beneficial in treating **osteoporosis**.

Vitamin D Is Toxic in Excess

Some infants are sensitive to intakes of vitamin D as low as 50 µg/d, resulting in an elevated plasma concentration of calcium. This can lead to contraction of blood vessels, high blood pressure, and **calcinosis**—the calcification of soft tissues. In at least a few cases, hypercalcemia in response to low intakes of vitamin D is due to genetic defects of calcidiol 24-hydroxylase, the enzyme that leads to inactivation of the vitamin. Although excess dietary vitamin D is toxic, excessive exposure to sunlight does not lead to vitamin D poisoning, because there is a limited capacity to form the precursor, 7-dehydrocholesterol, and prolonged exposure of previtamin D to sunlight leads to formation of inactive compounds.

VITAMIN E DOES NOT HAVE A PRECISELY DEFINED METABOLIC FUNCTION

No unequivocal unique function for vitamin E has been defined. It acts as a lipid-soluble **antioxidant** in cell membranes, where many of its functions can be provided by synthetic antioxidants, and is important in maintaining the fluidity of cell membranes. It also has a (relatively poorly

defined) role in cell signaling. Vitamin E is the generic descriptor for two families of compounds, the **tocopherols** and the **tocotrienols** (Figure 44–5). The different vitamers have different biologic potency; the most active is D- α -tocopherol, and it is usual to express vitamin E intake in terms of milligrams D- α -tocopherol equivalents. Synthetic DL- α -tocopherol does not have the same biologic potency as the naturally occurring compound.

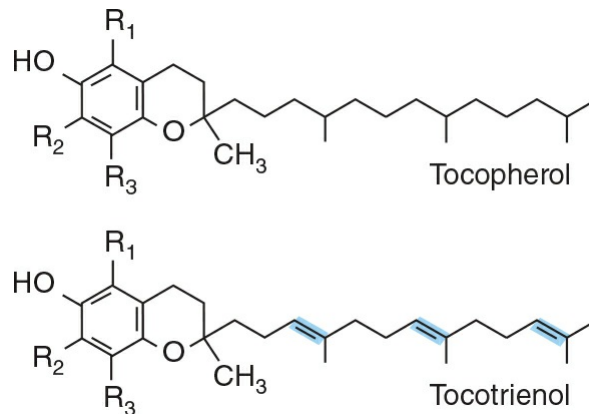

FIGURE 44–5 Vitamin E vitamers. In α -tocopherol and tocotrienol R₁, R₂, and R₃ are all –CH₃ groups. In the β -vitamers R₂ is H, in the γ -vitamers R₁ is H, and in the δ -vitamers R₁ and R₂ are both H.

Vitamin E Is the Major Lipid-Soluble Antioxidant in Cell Membranes & Plasma Lipoproteins

The main function of vitamin E is as a chain-breaking, free radical–trapping antioxidant in cell membranes and plasma lipoproteins by reacting with the lipid peroxide radicals formed by peroxidation of polyunsaturated fatty acids (see Chapter 45). The tocopheroxyl radical is relatively unreactive, and ultimately forms nonradical compounds. Commonly, the tocopheroxyl radical is reduced back to tocopherol by reaction with vitamin C from plasma. The resultant, stable, monodehydroascorbate radical then undergoes enzymic or nonenzymic reaction to yield ascorbate and dehydroascorbate, neither of which is a radical.

Vitamin E Deficiency

In experimental animals, vitamin E deficiency results in resorption of fetuses and testicular atrophy. Dietary deficiency of vitamin E in human beings is unknown, although patients with severe fat malabsorption, cystic

fibrosis, and some forms of chronic liver disease suffer deficiency because they are unable to absorb or transport the vitamin, leading to nerve and muscle membrane damage. Premature infants are born with inadequate reserves of the vitamin. The erythrocyte membranes are abnormally fragile as a result of lipid peroxidation, leading to hemolytic anemia.

VITAMIN K IS REQUIRED FOR SYNTHESIS OF BLOOD-CLOTTING PROTEINS

Vitamin K was discovered as a result of investigations into the cause of a bleeding disorder, hemorrhagic (sweet clover) disease of cattle and of chickens fed on a fat-free diet. The missing factor in the diet of the chickens was vitamin K, while the cattle feed contained **dicumarol**, an antagonist of the vitamin. Antagonists of vitamin K are used to reduce blood coagulation in patients at risk of thrombosis; the most widely used is **warfarin**.

Three compounds have the biological activity of vitamin K (**Figure 44-6**): **phylloquinone**, the normal dietary source, found in green vegetables; **menaquinones**, synthesized by intestinal bacteria, with differing lengths of side chain; and **menadione** and menadiol diacetate, synthetic compounds that can be metabolized to phylloquinone. Menaquinones are absorbed to some extent, but it is not clear to what extent they are biologically active as it is possible to induce signs of vitamin K deficiency simply by feeding a phylloquinone-deficient diet, without inhibiting intestinal bacterial action.

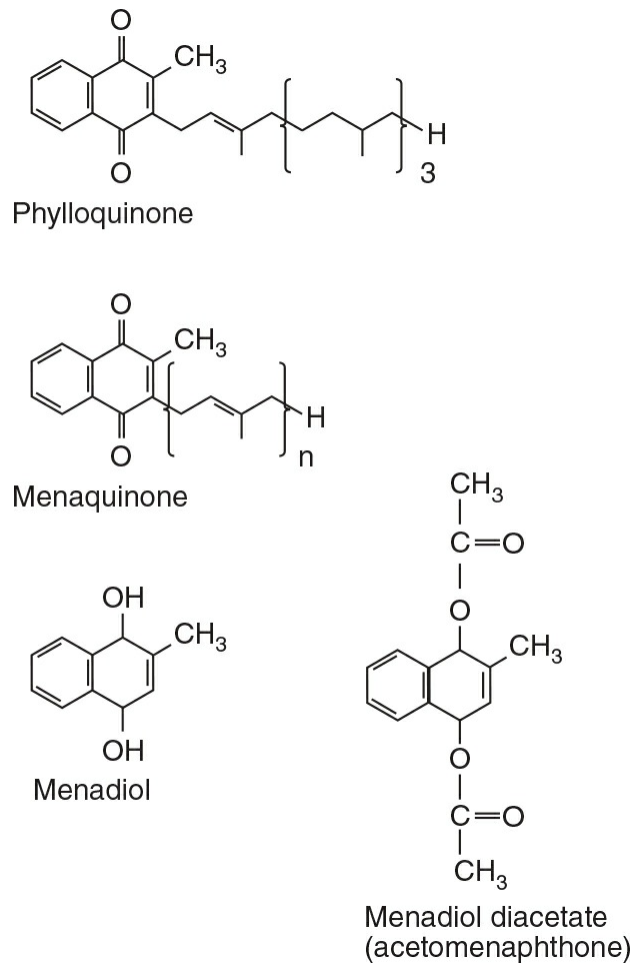

FIGURE 44–6 The vitamin K vitamers. Menadiol (or menadione) and menadiol diacetate are synthetic compounds that are converted to menaquinone in the liver.

Vitamin K Is the Coenzyme for Carboxylation of Glutamate in Postsynthetic Modification of Calcium-Binding Proteins

Vitamin K is the cofactor for the carboxylation of glutamate residues in the postsynthetic modification of proteins to form the unusual amino acid γ -carboxyglutamate (Gla) (**Figure 44–7**). Initially, vitamin K hydroquinone is oxidized to the epoxide, which activates a glutamate residue in the protein substrate to a carbanion, which reacts nonenzymically with carbon dioxide to form γ -carboxyglutamate. Vitamin K epoxide is reduced to the quinone by a warfarin-sensitive reductase, and the quinone is reduced to the active hydroquinone by either the same warfarin-sensitive reductase or a warfarin-insensitive quinone reductase. In the presence of warfarin, vitamin K epoxide cannot be reduced, but accumulates and is excreted. If

enough vitamin K (as the quinone) is provided in the diet, it can be reduced to the active hydroquinone by the warfarin-insensitive enzyme, and carboxylation can continue, with stoichiometric utilization of vitamin K and excretion of the epoxide. A high dose of vitamin K is the antidote to an overdose of warfarin.

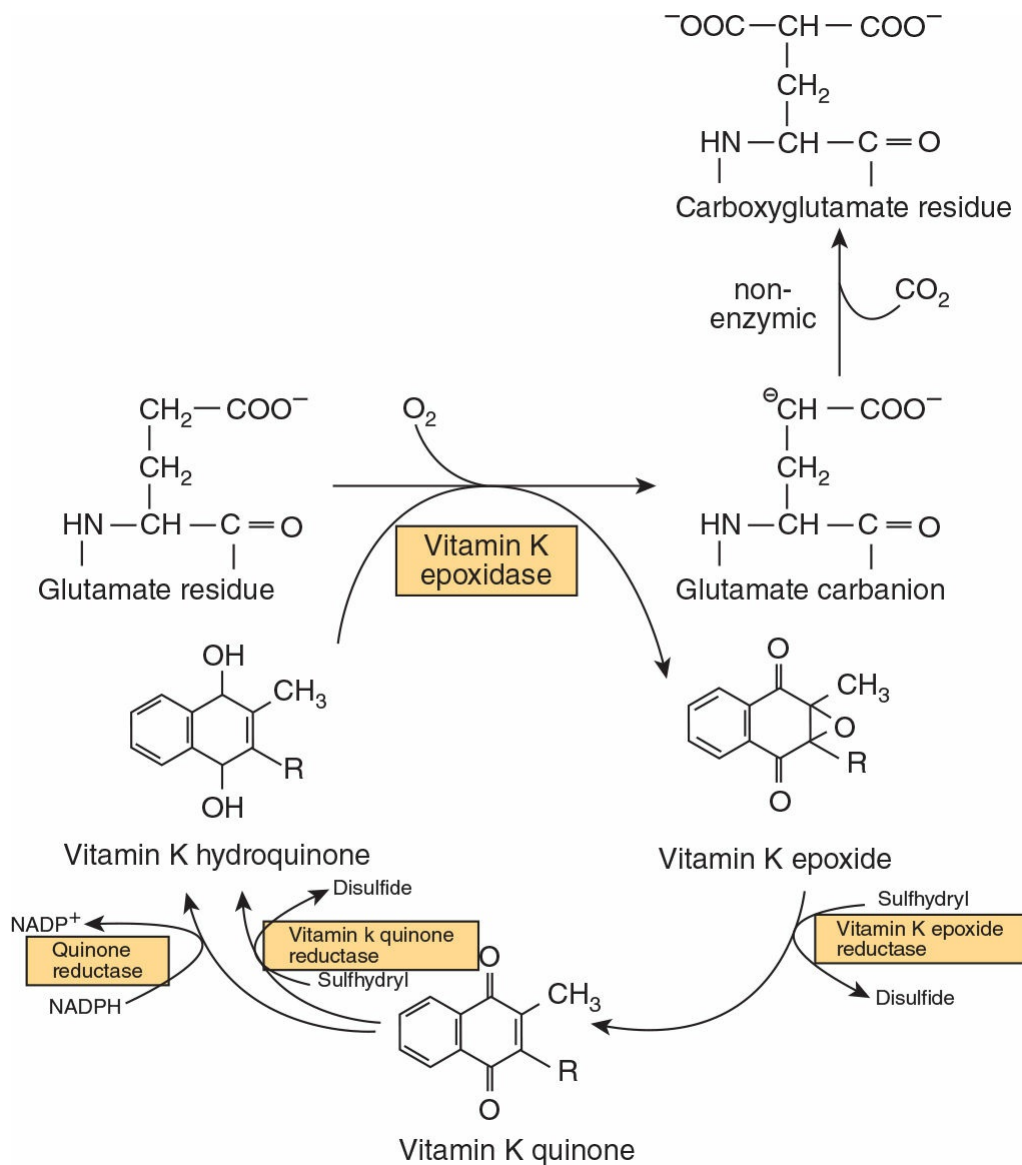

FIGURE 44-7 The role of vitamin K in the synthesis of γ -carboxyglutamate.

Prothrombin and several other proteins of the blood-clotting system (factors VII, IX, and X, and proteins C and S, [Chapter 52](#)) each contain 4 to 6 γ -carboxyglutamate residues. γ -Carboxyglutamate chelates calcium ions, and so permits the binding of the blood-clotting proteins to membranes. In vitamin K deficiency, or in the presence of warfarin, an

abnormal precursor of prothrombin (preprothrombin) containing little or no γ -carboxyglutamate, and incapable of chelating calcium, is released into the circulation.

Vitamin K Is Also Important in Synthesis of Bone & Other Calcium-Binding Proteins

A number of other proteins undergo the same vitamin K–dependent carboxylation of glutamate to γ -carboxyglutamate, including osteocalcin and the matrix Gla protein in bone, nephrocalcin in kidney and the product of the growth arrest specific gene *Gas6*, which is involved in both the regulation of differentiation and development in the nervous system, and control of apoptosis in other tissues. All of these γ -carboxyglutamate–containing proteins bind calcium, which causes a conformational change so that they interact with membrane phospholipids. The release into the circulation of osteocalcin provides an index of vitamin D status.

WATER-SOLUBLE VITAMINS

VITAMIN B₁ (THIAMIN) HAS A KEY ROLE IN CARBOHYDRATE METABOLISM

Thiamin has a central role in energy-yielding metabolism, and especially the metabolism of carbohydrates (**Figure 44–8**). **Thiamin diphosphate** is the coenzyme for three multienzyme complexes that catalyze oxidative decarboxylation reactions: pyruvate dehydrogenase in carbohydrate metabolism (see **Chapter 17**); α -ketoglutarate dehydrogenase in the citric acid cycle (see **Chapter 16**); and the branched-chain keto acid dehydrogenase involved in the metabolism of leucine, isoleucine, and valine (see **Chapter 29**). In each case, the thiamin diphosphate provides a reactive carbon on the thiazole moiety that forms a carbanion, which then adds to the carbonyl group, for example, pyruvate. The addition compound is then decarboxylated, eliminating CO_2 . Thiamin diphosphate is also the coenzyme for transketolase, in the pentose phosphate pathway (see **Chapter 20**).

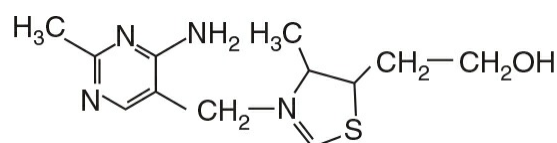

FIGURE 44–8 Thiamin.

Thiamin triphosphate has a role in nerve conduction; it phosphorylates, and so activates, a chloride channel in the nerve membrane.

Thiamin Deficiency Affects the Nervous System & the Heart

Thiamin deficiency can result in three distinct syndromes: a chronic peripheral neuritis, **beriberi**, which may or may not be associated with **heart failure** and **edema**; acute pernicious (fulminating) beriberi (Shoshin beriberi), in which heart failure and metabolic abnormalities predominate, without peripheral neuritis; and **Wernicke encephalopathy** with **Korsakoff psychosis**, which is associated especially with alcohol and narcotic abuse. The role of thiamin diphosphate in pyruvate dehydrogenase means that in deficiency there is impaired conversion of pyruvate to acetyl-CoA. In subjects on a relatively high carbohydrate diet, this results in increased plasma concentrations of lactate and pyruvate, which may cause life-threatening **lactic acidosis**.

Thiamin Nutritional Status Can Be Assessed by Erythrocyte Transketolase Activation

The activation of apotransketolase (the enzyme protein) in erythrocyte lysate by thiamin diphosphate added in vitro has become the accepted index of thiamin nutritional status.

VITAMIN B₂ (RIBOFLAVIN) HAS A CENTRAL ROLE IN ENERGY-YIELDING METABOLISM

Riboflavin provides the reactive moieties of the coenzymes **flavin mononucleotide (FMN)** and **flavin adenine dinucleotide (FAD)** (see [Figure 12–2](#)). FMN is formed by ATP-dependent phosphorylation of riboflavin; FAD is synthesized by further reaction with ATP in which the AMP moiety is transferred onto FMN. The main dietary sources of riboflavin are milk and dairy products. In addition, because of its intense yellow color, riboflavin is widely used as a food additive.

Flavin Coenzymes Are Electron Carriers in

Oxidoreduction Reactions

These include the mitochondrial respiratory chain, key enzymes in fatty acid and amino acid oxidation, and the citric acid cycle. Reoxidation of the reduced flavin in oxygenases and mixed-function oxidases proceeds by way of formation of the flavin radical and flavin hydroperoxide, with the intermediate generation of superoxide and perhydroxyl radicals and hydrogen peroxide. Because of this, flavin oxidases make a significant contribution to the total oxidant stress in the body (see [Chapter 45](#)).

Riboflavin Deficiency Is Widespread but Not Fatal

Although riboflavin is centrally involved in lipid and carbohydrate metabolism, and deficiency occurs in many countries, it is not fatal, because there is very efficient conservation of tissue riboflavin. Riboflavin released by the catabolism of enzymes is rapidly incorporated into newly synthesized enzymes. Deficiency is characterized by cheilosis, desquamation and inflammation of the tongue, and seborrheic dermatitis. Riboflavin nutritional status is assessed by measurement of the activation of erythrocyte glutathione reductase by FAD added in vitro.

NIACIN IS NOT STRICTLY A VITAMIN

Niacin was discovered as a nutrient during studies of **pellagra**. It is not strictly a vitamin since it can be synthesized in the body from the essential amino acid tryptophan. Two compounds, **nicotinic acid** and **nicotinamide**, have the biological activity of niacin; its metabolic function is as the nicotinamide ring of the coenzymes **NAD** and **NADP** in oxidation/reduction reactions (see [Figures 7–2](#) and [12–4](#)). Some 60 mg of tryptophan is equivalent to 1 mg of dietary niacin. The niacin content of foods is expressed as:

$$\begin{aligned} \text{mg niacin equivalents} &= \text{mg preformed niacin} \\ &+ 1/60 \times \text{mg tryptophan} \end{aligned}$$

Since most of the niacin in cereals is biologically unavailable, this is discounted.

NAD Is the Source of ADP-Ribose

In addition to its coenzyme role, NAD is the source of ADP-ribose for the **ADP-ribosylation** of proteins and polyADP-ribosylation of nucleoproteins

involved in the **DNA repair mechanism**. Cyclic ADP-ribose and nicotinic acid adenine dinucleotide, formed from NAD, act to increase intracellular calcium in response to neurotransmitters and hormones.

Pellagra Is Caused by Deficiency of Tryptophan & Niacin

Pellagra is characterized by a photosensitive dermatitis. As the condition progresses, there is depressive psychosis and possibly diarrhea. Untreated pellagra is fatal. Although the nutritional etiology of pellagra is well established, and either tryptophan or niacin prevents or cures the disease, additional factors, including deficiency of riboflavin or vitamin B₆, both of which are required for synthesis of nicotinamide from tryptophan, may be important. In most outbreaks of pellagra, twice as many women as men are affected, probably the result of inhibition of tryptophan metabolism by estrogen metabolites.

Pellagra Can Occur as a Result of Disease Despite an Adequate Intake of Tryptophan & Niacin

A number of genetic diseases that result in defects of tryptophan metabolism are associated with the development of pellagra, despite an apparently adequate intake of both tryptophan and niacin. **Hartnup disease** is a rare genetic condition in which there is a defect of the membrane transport mechanism for tryptophan, resulting in large losses as a result of intestinal malabsorption and failure of renal reabsorption. In **carcinoid syndrome**, there is metastasis of a primary liver tumor of enterochromaffin cells, which synthesize 5-hydroxytryptamine. Overproduction of 5-hydroxytryptamine may account for as much as 60% of the body's tryptophan metabolism, causing pellagra because of the diversion away from NAD synthesis.

Niacin Is Toxic in Excess

Nicotinic acid has been used to treat hyperlipidemia when of the order of 1 to 6 g/d are required, causing dilation of blood vessels and flushing, along with skin irritation. Intakes of both nicotinic acid and nicotinamide in excess of 500 mg/d cause liver damage.

VITAMIN B₆ IS IMPORTANT IN AMINO ACID & GLYCOGEN METABOLISM & IN STEROID HORMONE ACTION

Six compounds have vitamin B₆ activity (**Figure 44–9**): **pyridoxine**, **pyridoxal**, **pyridoxamine**, and their 5'-phosphates. The active coenzyme is pyridoxal 5'-phosphate. Some 80% of the body's total vitamin B₆ is pyridoxal phosphate in muscle, mostly associated with glycogen phosphorylase. This is not available in deficiency, but is released in starvation, when glycogen reserves become depleted, and is then available, especially to liver and kidney, to meet increased requirement for gluconeogenesis from amino acids.

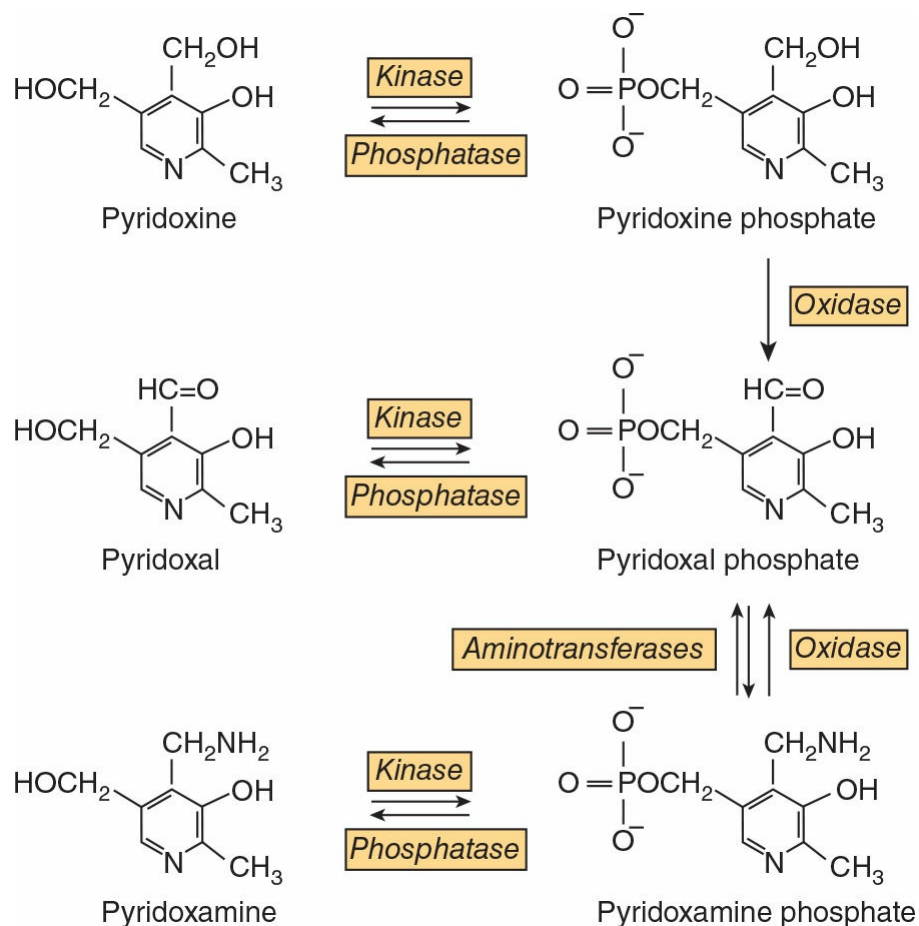

FIGURE 44–9 Interconversion of the vitamin B₆ vitamers.

Vitamin B₆ Has Several Roles in Metabolism

Pyridoxal phosphate is a coenzyme for many enzymes involved in amino

acid metabolism, especially transamination and decarboxylation. It is also the cofactor of glycogen phosphorylase, where the phosphate group is catalytically important. In addition, it is important in steroid hormone action. Pyridoxal phosphate removes the hormone-receptor complex from DNA binding, terminating the action of the hormones. In vitamin B₆ deficiency, there is increased sensitivity to the actions of low concentrations of estrogens, androgens, cortisol, and vitamin D.

Vitamin B₆ Deficiency Is Rare

Although clinical deficiency disease is rare, there is evidence that a significant proportion of the population has marginal vitamin B₆ status. Moderate deficiency results in abnormalities of tryptophan and methionine metabolism. Increased sensitivity to steroid hormone action may be important in the development of **hormone-dependent cancer** of the breast, uterus, and prostate, and vitamin B₆ status may affect the prognosis.

Vitamin B₆ Status Is Assessed by Assaying Erythrocyte Transaminases

The most widely used method of assessing vitamin B₆ status is by the activation of erythrocyte transaminases by pyridoxal phosphate added in vitro, expressed as the activation coefficient. Measurement of plasma concentrations of the vitamin is also used.

In Excess, Vitamin B₆ Causes Sensory Neuropathy

The development of sensory neuropathy has been reported in patients taking 2 to 7 g of pyridoxine per day for a variety of reasons. There was some residual damage after withdrawal of these high doses; other reports suggest that intakes in excess of 100 to 200 mg/d are associated with neurological damage.

VITAMIN B₁₂ IS FOUND ONLY IN FOODS OF ANIMAL ORIGIN

The term “vitamin B₁₂” is used as a generic descriptor for the **cobalamins**—those **corrinooids** (cobalt-containing compounds possessing the corrin

ring) having the biological activity of the vitamin (**Figure 44–10**). Some corrinoids that are growth factors for microorganisms not only have no vitamin B₁₂ activity, but may also be antimetabolites of the vitamin. Although it is synthesized exclusively by microorganisms, for practical purposes vitamin B₁₂ is found only in foods of animal origin, there being no plant sources of this vitamin. This means that strict vegetarians (vegans) are at risk of developing B₁₂ deficiency. The small amounts of the vitamin formed by bacteria on the surface of fruits may be adequate to meet requirements, but preparations of vitamin B₁₂ made by bacterial fermentation are available.

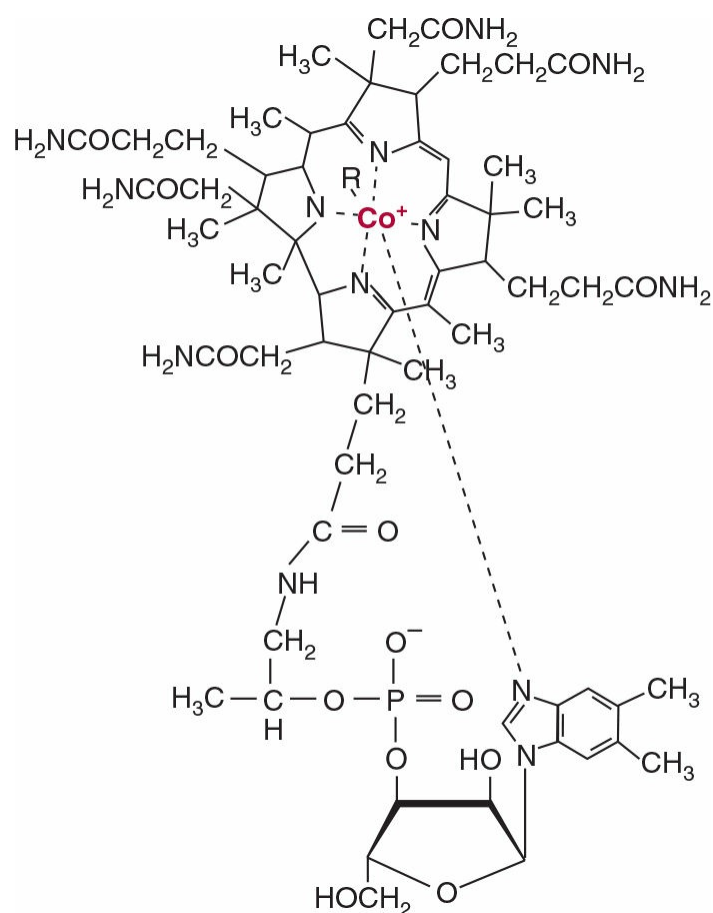

FIGURE 44–10 Vitamin B₁₂. Four coordination sites on the central cobalt atom are chelated by the nitrogen atoms of the corrin ring, and one by the nitrogen of the dimethylbenzimidazole nucleotide. The sixth coordination site may be occupied by CN⁻ (cyanocobalamin), OH⁻ (hydroxocobalamin), H₂O (aquocobalamin), —CH₃ (methyl cobalamin), or 5'-deoxyadenosine (adenosylcobalamin).

Vitamin B₁₂ Absorption Requires Two Binding Proteins

Vitamin B₁₂ is absorbed bound to **intrinsic factor**, a small glycoprotein secreted by the parietal cells of the gastric mucosa. Gastric acid and pepsin release the vitamin from protein binding in food and make it available to bind to **cobalophilin**, a binding protein secreted in the saliva. In the duodenum, cobalophilin is hydrolyzed, releasing the vitamin for binding to intrinsic factor. **Pancreatic insufficiency** can therefore be a factor in the development of vitamin B₁₂ deficiency, resulting in the excretion of cobalophilin-bound vitamin B₁₂. Intrinsic factor binds only the active vitamin B₁₂ vitamers and not other corrinoids. Vitamin B₁₂ is absorbed from the distal third of the ileum via receptors that bind the intrinsic factor–vitamin B₁₂ complex, but not free intrinsic factor or free vitamin. There is considerable enterohepatic circulation of vitamin B₁₂, with excretion in the bile, then reabsorption after binding to intrinsic factor in the ileum.

There Are Two Vitamin B₁₂–Dependent Enzymes

Methylmalonyl-CoA mutase, and **methionine synthase** (Figure 44–11) are vitamin B₁₂–dependent enzymes. Methylmalonyl-CoA is formed as an intermediate in the catabolism of valine and by the carboxylation of propionyl-CoA arising in the catabolism of isoleucine, cholesterol, and rare fatty acids with an odd number of carbon atoms, or directly from propionate, a major product of microbial fermentation ruminants. It undergoes a vitamin B₁₂–dependent rearrangement to succinyl-CoA, catalyzed by methylmalonyl-CoA mutase (see Figure 19–2). The activity of this enzyme is greatly reduced in vitamin B₁₂ deficiency, leading to an accumulation of methylmalonyl-CoA and urinary excretion of methylmalonic acid, which provides a means of assessing vitamin B₁₂ nutritional status.

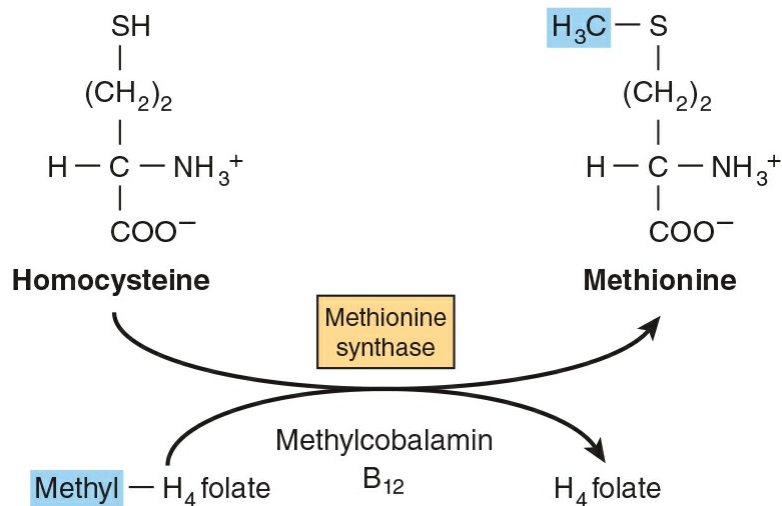

FIGURE 44–11 Homocysteine and the folate trap. Vitamin B₁₂ deficiency leads to impairment of methionine synthase, resulting in accumulation of homocysteine and trapping folate as methyltetrahydrofolate.

Vitamin B₁₂ Deficiency Causes Pernicious Anemia

Pernicious anemia arises when vitamin B₁₂ deficiency impairs the metabolism of folic acid, leading to functional folate deficiency that disturbs erythropoiesis, causing immature precursors of erythrocytes to be released into the circulation (megaloblastic anemia). The most common cause of pernicious anemia is failure of the absorption of vitamin B₁₂ rather than dietary deficiency. This can be the result of failure of intrinsic factor secretion caused by autoimmune disease affecting parietal cells or from production of anti-intrinsic factor antibodies. There is irreversible degeneration of the spinal cord in pernicious anemia, as a result of failure of methylation of one arginine residue in myelin basic protein. This is the result of methionine deficiency in the central nervous system, rather than secondary folate deficiency.

THERE ARE MULTIPLE FORMS OF FOLATE IN THE DIET

The active form of folic acid (pteroyl glutamate) is tetrahydrofolate (**Figure 44–12**). The folates in foods may have up to seven additional glutamate residues linked by γ -peptide bonds. In addition, all of the one-carbon substituted folates in **Figure 44–12** may also be present in foods. The extent to which the different forms of folate can be absorbed varies,

and folate intakes are calculated as dietary folate equivalents—the sum of μg food folates + $1.7 \times \mu\text{g}$ of folic acid (used in food enrichment).

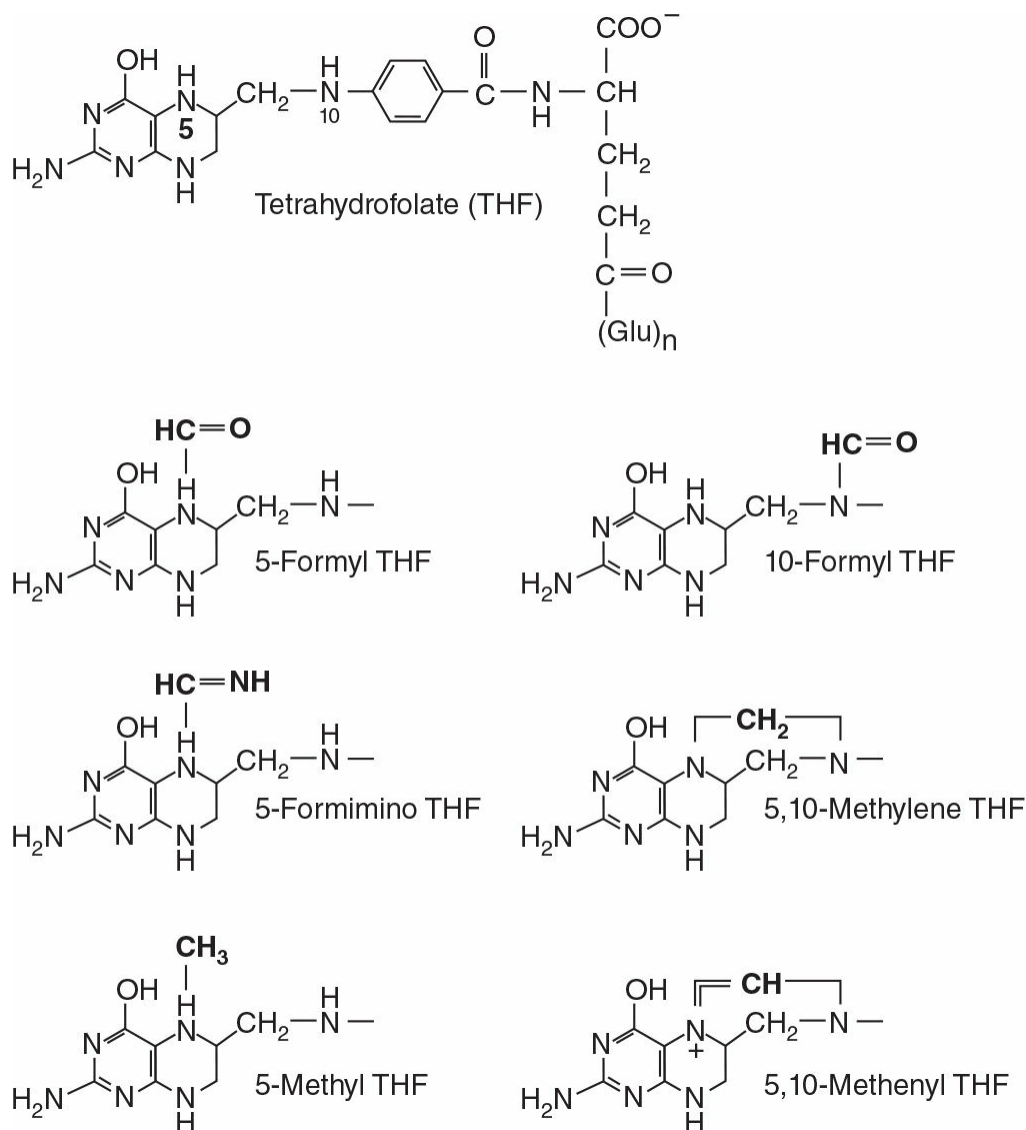

FIGURE 44-12 Tetrahydrofolic acid and the one-carbon substituted folates.

Tetrahydrofolate Is a Carrier of One-Carbon Units

Tetrahydrofolate can carry one-carbon fragments attached to *N*-5 (formyl, formimino, or methyl groups), *N*-10 (formyl) or bridging *N*-5–*N*-10 (methylene or methenyl groups). 5-Formyl-tetrahydrofolate is more stable than folate and is therefore used pharmaceutically (known as **folinic acid**), and the synthetic (racemic) compound (**leucovorin**). The major point of entry for one-carbon fragments into substituted folates is methylenetetrahydrofolate (**Figure 44-13**), which is formed by the

reaction of glycine, serine, and choline with tetrahydrofolate. Serine is the most important source of substituted folates for biosynthetic reactions, and the activity of serine hydroxymethyltransferase is regulated by the state of folate substitution and the availability of folate. The reaction is reversible, and in liver it can form serine from glycine as a substrate for gluconeogenesis. Methylene-, methenyl-, and 10-formyltetrahydrofolates are interconvertible. When one-carbon folates are not required, the oxidation of formyltetrahydrofolate to yield carbon dioxide provides a means of maintaining a pool of free folate.

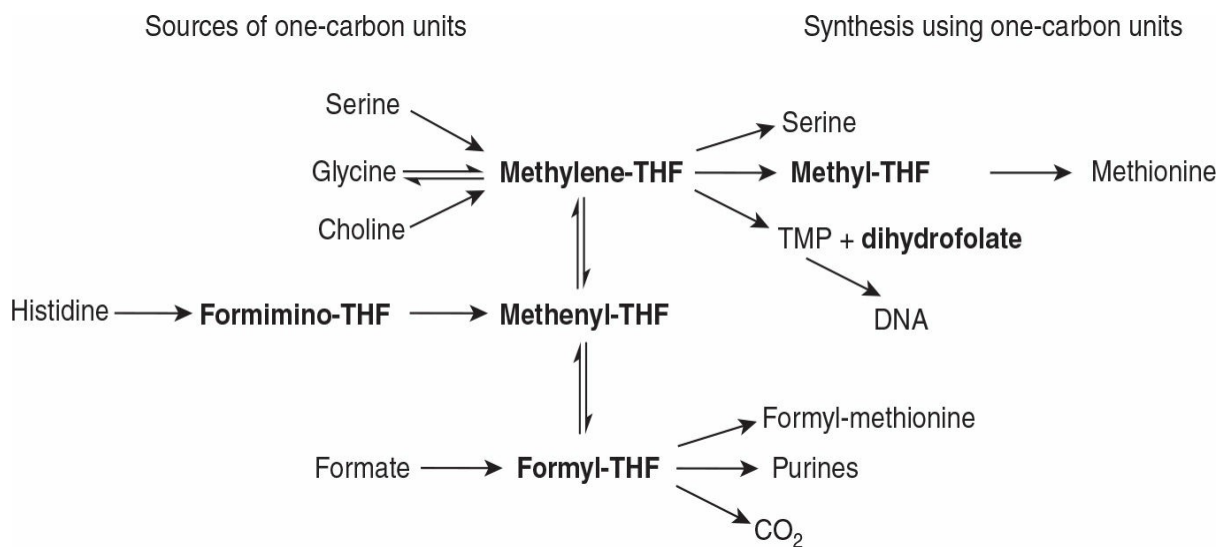

FIGURE 44–13 Sources and utilization of one-carbon substituted folates.

Inhibitors of Folate Metabolism Provide Cancer Chemotherapy, Antibacterial, & Antimalarial Drugs

The methylation of deoxyuridine monophosphate (dUMP) to thymidine monophosphate (TMP), catalyzed by thymidylate synthase, is essential for the synthesis of DNA. The one-carbon fragment of methylene-tetrahydrofolate is reduced to a methyl group with release of dihydrofolate, which is then reduced back to tetrahydrofolate by **dihydrofolate reductase**. Thymidylate synthase and dihydrofolate reductase are especially active in tissues with a high rate of cell division. **Methotrexate**, an analog of 10-methyltetrahydrofolate, inhibits dihydrofolate reductase and is used as in cancer chemotherapy. The dihydrofolate reductases of some bacteria and parasites differ from the human enzyme; inhibitors of these enzymes can be used as antibacterial drugs (eg, **trimethoprim**) and antimalarial drugs (eg, **pyrimethamine**).

Vitamin B₁₂ Deficiency Causes Functional Folate Deficiency—the “Folate Trap”

When acting as a methyl donor, *S*-adenosyl methionine forms homocysteine, which may be remethylated by methyltetrahydrofolate catalyzed by methionine synthase, a vitamin B₁₂-dependent enzyme (Figure 44–11). As the reduction of methylenetetrahydrofolate to methyltetrahydrofolate is irreversible and the major source of tetrahydrofolate for tissues is methyltetrahydrofolate, the role of methionine synthase is vital, and provides a link between the functions of folate and vitamin B₁₂. Impairment of methionine synthase in vitamin B₁₂ deficiency results in the accumulation of methyltetrahydrofolate that cannot be used—the “folate trap.” There is therefore functional deficiency of folate, secondary to the deficiency of vitamin B₁₂.

Folate Deficiency Causes Megaloblastic Anemia

Deficiency of folic acid itself or deficiency of vitamin B₁₂, which leads to functional folic acid deficiency, affects cells that are dividing rapidly because they have a large requirement for thymidine for DNA synthesis. Clinically, this affects the bone marrow, leading to megaloblastic anemia.

Folic Acid Supplements Reduce the Risk of Neural Tube Defects & Hyperhomocysteinemia, & May Reduce the Incidence of Cardiovascular Disease & Some Cancers

Supplements of 400 µg/d of folic acid begun before conception result in a significant reduction in the incidence of **spina bifida** and other **neural tube defects**. Because of this, there is mandatory enrichment of flour with folic acid in many countries. Elevated blood homocysteine is a significant risk factor for **atherosclerosis**, **thrombosis**, and **hypertension**. The condition is the result of an impaired ability to form methyltetrahydrofolate by methylenetetrahydrofolate reductase, causing functional folate deficiency, resulting in failure to remethylate homocysteine to methionine. People with an abnormal variant of methylenetetrahydrofolate reductase that occurs in 5 to 10% of the population do not develop hyperhomocysteinemia if they have a relatively high intake of folate. A number of placebo-controlled trials of supplements

of folate (commonly together with vitamins B₆ and B₁₂) have shown the expected lowering of plasma homocysteine, but apart from reduced incidence of stroke there has been no effect on death from cardiovascular disease.

There is also evidence that low folate status results in impaired methylation of CpG islands in DNA, which is a factor in the development of colorectal and other cancers. A number of studies suggest that folic acid supplementation or food enrichment may reduce the risk of developing some cancers. However, there is also some evidence that folate supplements increase the rate of transformation of preneoplastic colorectal polyps into cancers, so that people with such polyps may be at increased risk of developing colorectal cancer if they have a high folate intake.

Folic Acid Enrichment of Foods May Put Some People at Risk

Folic acid supplements will rectify the megaloblastic anemia of vitamin B₁₂ deficiency but not the irreversible nerve damage. A high intake of folic acid can thus mask vitamin B₁₂ deficiency. This is especially a problem for elderly people, since atrophic gastritis that develops with increasing age leads to failure of gastric acid secretion, and hence failure to release vitamin B₁₂ from dietary proteins. Because of this, although many countries have adopted mandatory enrichment of flour with folic acid to prevent neural tube defects, others have not. There is also antagonism between folic acid and some anticonvulsants used in the treatment of epilepsy, and, as noted above, there is some evidence that folate supplements may increase the risk of developing colorectal cancer among people with preneoplastic colorectal polyps.

DIETARY BIOTIN DEFICIENCY IS UNKNOWN

The structures of biotin, biocytin, and carboxybiotin (the active metabolic intermediate) are shown in **Figure 44–14**. Biotin is widely distributed in many foods as biocytin (ϵ -amino-biotinyl lysine), which is released on proteolysis. It is synthesized by intestinal flora in excess of requirements. Deficiency is unknown, except among people maintained for many months on total parenteral nutrition, and a very small number who eat abnormally large amounts of uncooked egg white, which contains avidin, a protein that binds biotin and renders it unavailable for absorption.

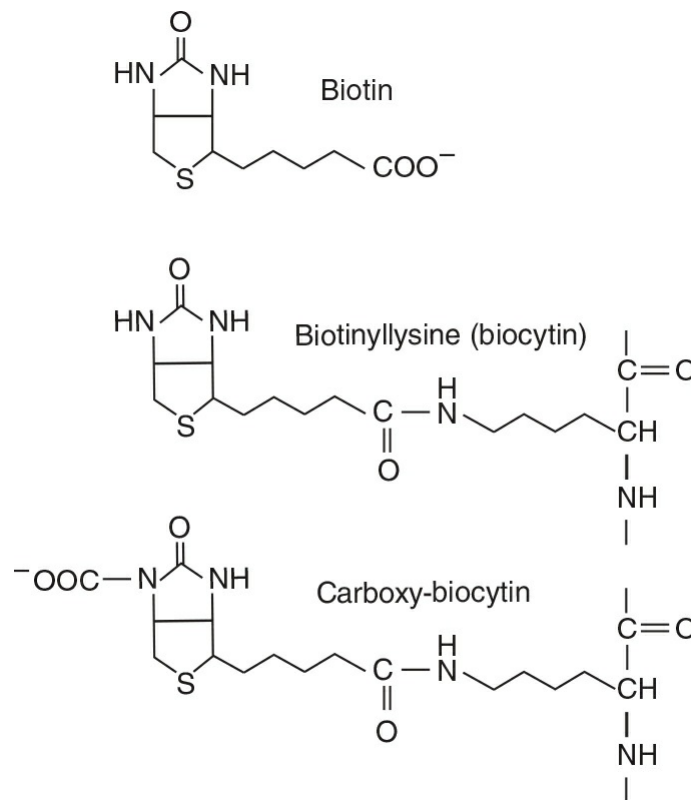

FIGURE 44–14 Biotin, biocytin, and carboxybiocytin.

Biotin Is a Coenzyme of Carboxylase Enzymes

Biotin functions to transfer carbon dioxide in a small number of reactions: acetyl-CoA carboxylase (see [Figure 23–1](#)), pyruvate carboxylase (see [Figure 19–1](#)), propionyl-CoA carboxylase (see [Figure 19–2](#)), and methylcrotonyl-CoA carboxylase. A holocarboxylase synthetase catalyzes the transfer of biotin onto a lysine residue of the apoenzyme to form the biocytin residue of the holoenzyme. The reactive intermediate is 1-*N*-carboxybiocytin, formed from bicarbonate in an ATP-dependent reaction. The carboxyl group is then transferred to the substrate for carboxylation.

Biotin also has a role in regulation of the cell cycle, acting to biotinylate key nuclear proteins.

AS PART OF COENZYME A & ACP, PANTOTHENIC ACID ACTS AS A CARRIER OF ACYL GROUPS

Pantothenic acid has a central role in acyl group metabolism when acting as the pantothenic functional moiety of coenzyme A (CoA) or acyl carrier protein (ACP) ([Figure 44–15](#)). The pantothenic moiety is formed after

combination of pantothenate with cysteine, which provides the—SH prosthetic group of CoA and ACP. CoA takes part in reactions of the citric acid cycle (see [Chapter 16](#)), fatty acid oxidation (see [Chapter 22](#)), acetylations, and cholesterol synthesis (see [Chapter 26](#)). ACP participates in fatty acid synthesis (see [Chapter 23](#)). The vitamin is widely distributed in all foodstuffs, and deficiency has not been unequivocally reported in humans except in specific depletion studies.

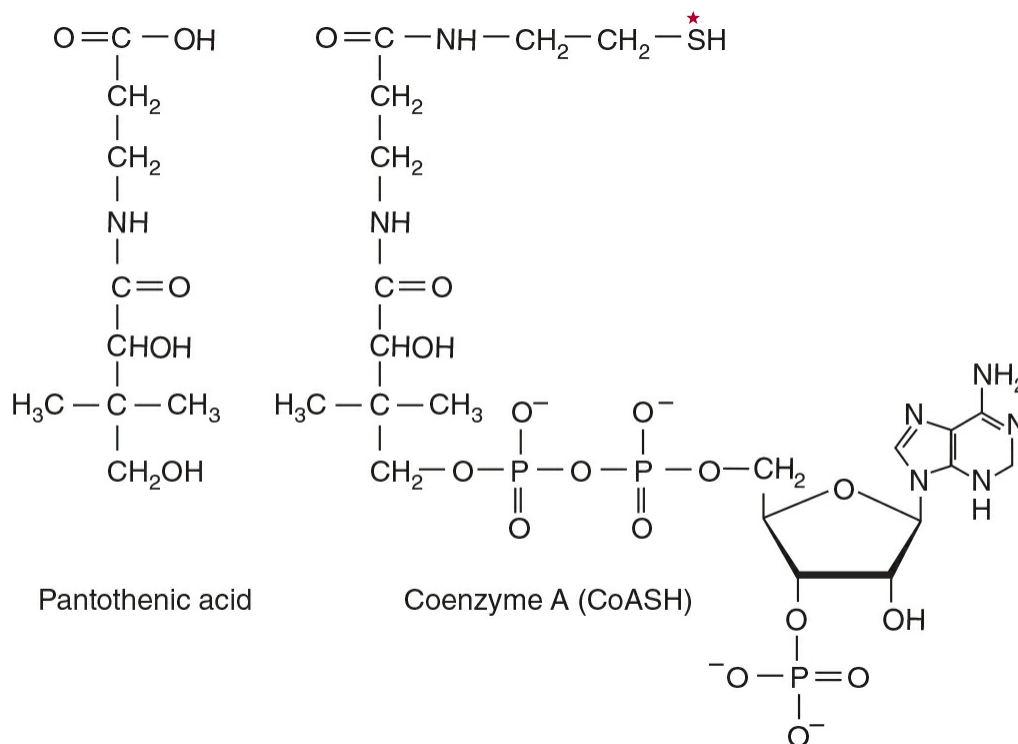

FIGURE 44–15 Pantothenic acid and coenzyme A. Asterisk shows site of acylation by fatty acids.

ASCORBIC ACID IS A VITAMIN FOR ONLY SOME SPECIES

Vitamin C ([Figure 44–16](#)) is a vitamin for human beings and other primates, the guinea pig, bats, passeriform birds, and most fishes and invertebrates; other animals synthesize it as an intermediate in the uronic acid pathway of glucose metabolism (see [Figure 20–4](#)). In those species for which it is a vitamin, gulonolactone oxidase is absent. Both ascorbic acid and dehydroascorbic acid have vitamin activity.

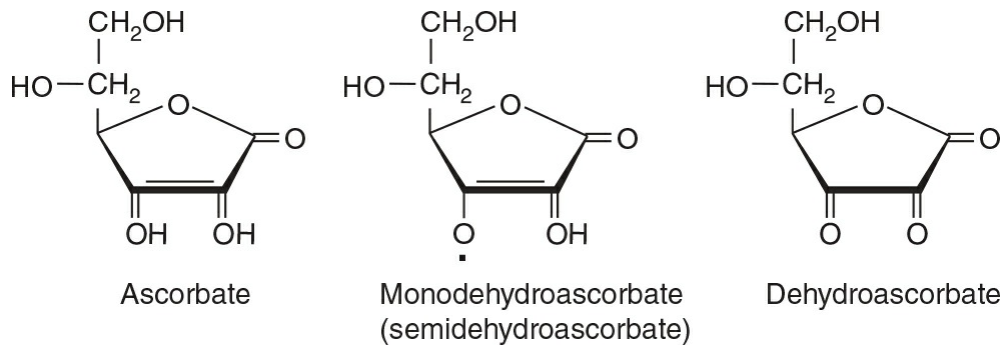

FIGURE 44–16 Vitamin C.

Vitamin C Is the Coenzyme for Two Groups of Hydroxylases

Ascorbic acid has specific roles in the copper-containing hydroxylases and the α -ketoglutarate–linked iron-containing hydroxylases. It also increases the activity of a number of other enzymes *in vitro*, although this is a nonspecific reducing action. In addition, it has a number of nonenzymic effects as a result of its action as a reducing agent and oxygen radical quencher (see [Chapter 45](#)).

Dopamine β -hydroxylase is a copper-containing enzyme involved in the synthesis of the catecholamines (norepinephrine and epinephrine), from tyrosine in the adrenal medulla and central nervous system. During hydroxylation the Cu^+ is oxidized to Cu^{2+} ; reduction back to Cu^+ specifically requires ascorbate, which is oxidized to monodehydroascorbate.

A number of peptide hormones have a carboxy-terminal amide that is derived from a terminal glycine residue. This glycine is hydroxylated on the α -carbon by a copper-containing enzyme, **peptidylglycine hydroxylase**, which, again, requires ascorbate for reduction of Cu^{2+} .

A number of iron-containing, ascorbate-requiring hydroxylases share a common reaction mechanism, in which hydroxylation of the substrate is linked to oxidative decarboxylation of α -ketoglutarate. Many of these enzymes are involved in the modification of precursor proteins. **Proline** and **lysine hydroxylases** are required for the postsynthetic modification of **procollagen** to **collagen**, and proline hydroxylase is also required in formation of **osteocalcin** and the C1q component of **complement**. Aspartate β -hydroxylase is required for the postsynthetic modification of the precursor of protein C, the vitamin K–dependent protease that hydrolyzes activated factor V in the blood-clotting cascade (see [Chapter](#)

52). Trimethyllysine and γ -butyrobetaine hydroxylases are required for the synthesis of carnitine. In these enzymes ascorbate is required to reduce the iron prosthetic group after accidental oxidation during reaction; it is neither consumed stoichiometrically with the substrates nor does it have a simple catalytic role.

Vitamin C Deficiency Causes Scurvy

Signs of vitamin C deficiency include skin changes, fragility of blood capillaries, gum decay, tooth loss, and bone fracture, which can be attributed to impaired collagen synthesis, and psychological changes that can be attributed to impaired synthesis of catecholamines.

There May Be Benefits From Higher Intakes of Vitamin C

At intakes above about 100 mg/d, the body's capacity to metabolize vitamin C is saturated, and any further intake is excreted in the urine. However, in addition to its other roles, vitamin C enhances the absorption of inorganic iron, and this depends on the presence of the vitamin in the gut. Therefore, increased intakes may be beneficial, and it is frequently prescribed together with iron supplements to treat iron deficiency anemia. There is very little good evidence that high doses of vitamin C prevent the common cold, although they may reduce the duration and severity of symptoms.

MINERALS ARE REQUIRED FOR BOTH PHYSIOLOGIC & BIOCHEMICAL FUNCTIONS

Many of the essential minerals (**Table 44–2**) are widely distributed in foods, and most people eating a mixed diet are likely to receive adequate intakes. The amounts required vary from grams per day for sodium and calcium, through milligrams per day (eg, iron and zinc), to micrograms per day for the trace elements. In general, mineral deficiencies occur when foods come from one region where the soil may be deficient in some minerals (eg, iodine and selenium, deficiencies of both of which occur in many areas of the world). When foods come from a variety of regions, mineral deficiency is less likely to occur. Iron deficiency is an important problem worldwide, because if iron losses from the body are relatively high (eg, from heavy menstrual blood loss or intestinal parasites), it is

difficult to achieve an adequate intake to replace losses. However, 10% of the population (and more in some areas) are genetically at risk of iron overload, leading to formation of free radicals as a result of nonenzymic reactions of iron ions in free solution when the capacity of iron-binding proteins has been exceeded. Foods grown on soil containing high levels of selenium cause toxicity, and excessive intakes of sodium cause hypertension in susceptible people.

TABLE 44–2 Classification of Minerals According to Their Function

Function	Mineral
Structural function	Calcium, magnesium, phosphate
Involved in membrane function	Sodium, potassium
Function as prosthetic groups in enzymes	Cobalt, copper, iron, molybdenum, selenium, zinc
Regulatory role or role in hormone action	Calcium, chromium, iodine, magnesium, manganese, sodium, potassium
Known to be essential, but function unknown	Silicon, vanadium, nickel, tin
Have effects in the body, but essentiality is not established	Fluoride, lithium
May occur in foods and known to be toxic in excess	Aluminum, arsenic, antimony, boron, bromine, cadmium, cesium, germanium, lead, mercury, silver, strontium

SUMMARY

- Vitamins are organic nutrients with essential metabolic functions that are required in small amounts in the diet because they cannot be synthesized by the body. The lipid-soluble vitamins (A, D, E, and K) are hydrophobic molecules requiring normal fat absorption for their absorption.
- Vitamin A (retinol), present in meat, and the provitamin (β -carotene), found in plants, form retinaldehyde, utilized in vision, and retinoic acid, which acts in the control of gene expression.

- Vitamin D is a steroid prohormone yielding the active hormone calcitriol, which regulates calcium and phosphate metabolism; deficiency leads to rickets and osteomalacia. It has a role in controlling cell differentiation and insulin secretion.
- Vitamin E (tocopherol) is the most important lipid-soluble antioxidant in the body, acting in the lipid phase of membranes protecting against the effects of free radicals.
- Vitamin K functions act as the cofactor of a carboxylase that acts on glutamate residues of precursor proteins of clotting factors and bone and other proteins to enable them to chelate calcium.
- The water-soluble vitamins act as enzyme cofactors. Thiamin is a cofactor in oxidative decarboxylation of α -keto acids and of transketolase in the pentose phosphate pathway. Riboflavin and niacin are important cofactors in oxidoreduction reactions, present in flavoprotein enzymes and in NAD and NADP, respectively.
- Pantothenic acid is present in coenzyme A and acyl carrier protein, which act as carriers of acyl groups in metabolic reactions.
- Vitamin B₆ as pyridoxal phosphate is the coenzyme for several enzymes of amino acid metabolism, including the transaminases, and of glycogen phosphorylase. Biotin is the coenzyme for several carboxylase enzymes.
- Vitamin B₁₂ and folate provide one-carbon residues for DNA synthesis and other reactions; deficiency results in megaloblastic anemia.
- Vitamin C is a water-soluble antioxidant that maintains vitamin E and many metal cofactors in the reduced state.
- Inorganic mineral elements that have a function in the body must be provided in the diet. When intake is insufficient, deficiency may develop, and excessive intakes may be toxic.

Free Radicals & Antioxidant Nutrients

David A. Bender, PhD

OBJECTIVES

After studying this chapter, you should be able to:

- Describe the damage caused to DNA, lipids, and proteins by free radicals, and the diseases associated with radical damage.
- Describe the main sources of oxygen radicals in the body.
- Describe the mechanisms and dietary factors that protect against radical damage.
- Explain how antioxidants can also act as pro-oxidants, and why intervention trials of antioxidant nutrients have generally yielded disappointing results.

BIOMEDICAL IMPORTANCE

Free radicals are formed in the body under normal conditions. They cause damage to nucleic acids, proteins, and lipids in cell membranes and plasma lipoproteins. This can cause cancer, atherosclerosis and coronary artery

disease, and autoimmune diseases. Epidemiological and laboratory studies have identified a number of protective antioxidant nutrients: selenium, vitamins C and E, β -carotene, and other carotenoids, and a variety of polyphenolic compounds derived from plant foods. Many people take supplements of one or more antioxidant nutrients. However, intervention trials show little benefit of antioxidant supplements except among people who were initially deficient, and many trials of β -carotene and vitamin E have shown increased mortality among those taking the supplements.

Free Radical Reactions Are Self-Perpetuating Chain Reactions

Free radicals are highly reactive molecular species with an unpaired electron; they persist for only a very short time (of the order of 10^{-9} to 10^{-12} seconds) before they collide with another molecule and either abstract or donate an electron in order to achieve stability. In so doing, they generate a new radical from the molecule with which they collided. The main way in which a free radical can be quenched, so terminating this chain reaction, is if two radicals react together, when the unpaired electrons can become paired in one or other of the parent molecules. This is a rare occurrence, because of the very short half-life of an individual radical and the very low concentrations of radicals in tissues.

The most damaging radicals in biological systems are oxygen radicals (sometimes called reactive oxygen species)—especially superoxide, $\cdot\text{O}_2^-$, hydroxyl, $\cdot\text{OH}$, and perhydroxyl, $\cdot\text{O}_2\text{H}$. Tissue damage caused by oxygen radicals is often called oxidative damage, and factors that protect against oxygen radical damage are known as antioxidants.

Radicals Can Damage DNA, Lipids, & Proteins

Interaction of radicals with bases in DNA can lead to chemical changes that, if not repaired (see [Chapter 35](#)), may be inherited in daughter cells. Radical damage to unsaturated fatty acids in cell membranes and plasma lipoproteins leads to the formation of lipid peroxides, then highly reactive dialdehydes that can chemically modify proteins and nucleic acid bases. Proteins are also subject to direct chemical modification by interaction with radicals. Oxidative damage to tyrosine residues in proteins can lead to the formation of dihydroxyphenylalanine that can undergo nonenzymic reactions leading to further formation of oxygen radicals ([Figure 45–1](#)).

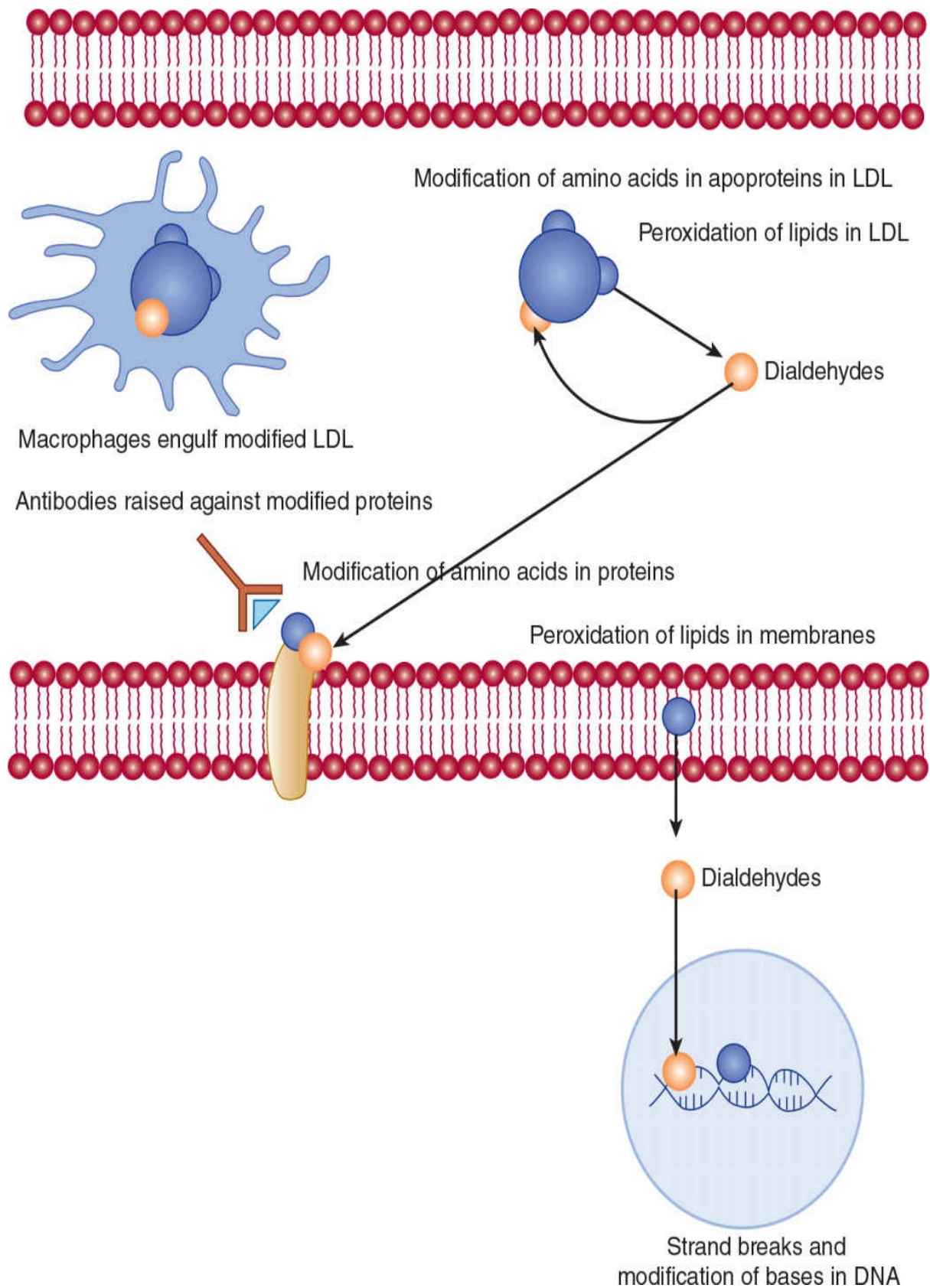

FIGURE 45–1 Tissue damage by radicals.

The total body radical burden can be estimated by measuring the

products of lipid peroxidation. Lipid peroxides can be measured by the ferrous oxidation in xylenol orange (FOX) assay. Under acidic conditions, they oxidize Fe^{2+} to Fe^{3+} , which forms a chromophore with xylenol orange. The dialdehydes formed from lipid peroxides can be measured by reaction with thiobarbituric acid, when they form a red fluorescent adduct—the results of this assay are generally reported as total thiobarbituric acid reactive substances, TBARS. Peroxidation of n-6 polyunsaturated fatty acids leads to the formation of pentane, and of n-3 polyunsaturated fatty acids to ethane, both of which can be measured in exhaled air.

Radical Damage May Cause Mutations, Cancer, Autoimmune Disease, & Atherosclerosis

Radical damage to DNA in germline cells in ovaries and testes can lead to heritable mutations; in somatic cells, the result may be initiation of cancer. The dialdehydes formed as a result of radical-induced lipid peroxidation in cell membranes can also modify bases in DNA.

Chemical modification of amino acids in proteins, either by direct radical action or as a result of reaction with the products of radical-induced lipid peroxidation, leads to proteins that are recognized as nonself by the immune system. The resultant antibodies will also cross-react with normal tissue proteins, so initiating autoimmune disease.

Chemical modification of the proteins or lipids in plasma low-density lipoprotein (LDL) leads to abnormal LDL that is not recognized by the liver LDL receptors, and so is not cleared by the liver. The modified LDL is taken up by macrophage scavenger receptors. Lipid-engorged macrophages infiltrate under blood vessel endothelium (especially when there is already some damage to the endothelium), and are killed by the high content of unesterified cholesterol they have accumulated. This occurs in the development of atherosclerotic plaques, which, in extreme cases, can more or less completely occlude a blood vessel.

There Are Multiple Sources of Oxygen Radicals in the Body

Ionizing radiation (x-rays and UV) can lyse water, leading to the formation of hydroxyl radicals. Transition metal ions, including Cu^+ , Co^{2+} , Ni^{2+} , and Fe^{2+} can react nonenzymically with oxygen or hydrogen peroxide, again leading to the formation of hydroxyl radicals. Nitric oxide (an

important compound in cell signaling, originally described as the endothelium-derived relaxation factor) is itself a radical, and, more importantly, can react with superoxide to yield peroxynitrite, which decays to form hydroxyl radicals (**Figure 45–2**).

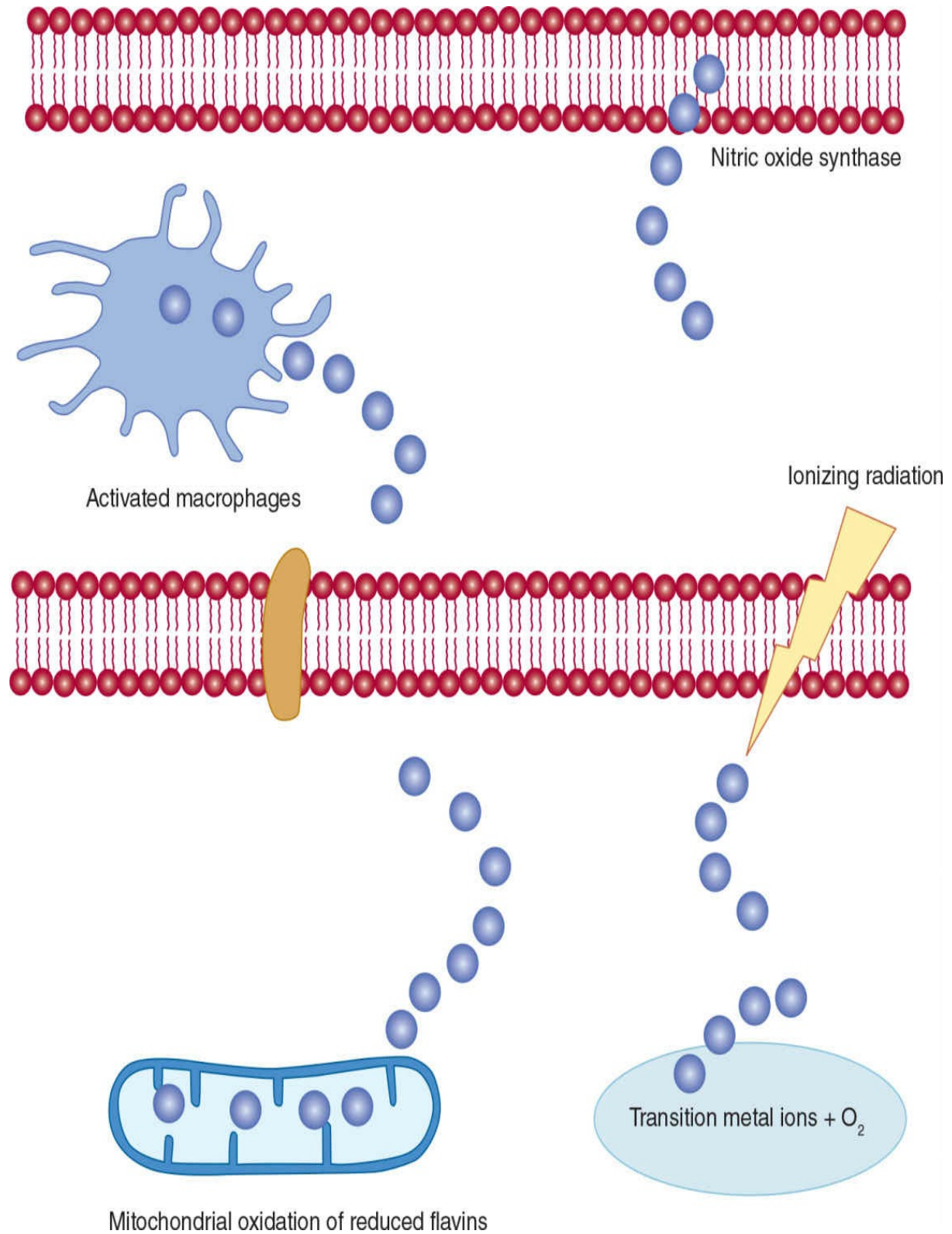

FIGURE 45–2 Sources of radicals.

The respiratory burst of activated macrophages (see [Chapter 53](#)) is increased utilization of glucose via the pentose phosphate pathway (see [Chapter 20](#)) to reduce NADP^+ to NADPH, and increased utilization of oxygen to oxidize NADPH to produce oxygen (and halogen) radicals as cytotoxic agents to kill phagocytosed microorganisms. The respiratory burst oxidase (NADPH oxidase) is a flavoprotein that reduces oxygen to superoxide:



Plasma markers of radical damage to lipids increase considerably in response to even a mild infection.

The oxidation of reduced flavin coenzymes in the mitochondrial (see [Chapter 13](#)) and microsomal electron transport chains proceeds through a series of steps in which the flavin semiquinone radical is stabilized by the protein to which it is bound, and forms oxygen radicals as transient intermediates. Although the final products are not radicals, because of the unpredictable nature of radicals there is considerable “leakage” of radicals, and some 3 to 5% of the daily consumption of 30 mol of oxygen by an adult human being is converted to singlet oxygen, hydrogen peroxide, and superoxide, perhydroxyl, and hydroxyl radicals, rather than undergoing complete reduction to water. This results in daily production of about 1.5 mol of reactive oxygen species.

There Are Various Mechanisms of Protection Against Radical Damage

The metal ions that undergo nonenzymic reaction to form oxygen radicals are not normally free in solution, but are bound to either the proteins for which they provide the prosthetic group, or to specific transport and storage proteins, so that they are unreactive. Iron is bound to transferrin, ferritin, and hemosiderin, copper to ceruloplasmin, and other metal ions are bound to metallothionein. This binding to transport proteins that are too large to be filtered in the kidneys also prevents loss of metal ions in the urine.

Superoxide is produced both accidentally and also as the reactive oxygen species required for a number of enzyme-catalyzed reactions. A family of superoxide dismutases catalyze the reaction between superoxide

and protons to yield oxygen and hydrogen peroxide:

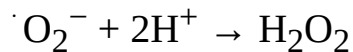

The hydrogen peroxide is then removed by catalase and various peroxidases: $2\text{H}_2\text{O}_2 \rightarrow 2\text{H}_2\text{O} + \text{O}_2$. Most enzymes that produce and require superoxide are contained in the peroxisomes, together with superoxide dismutase, catalase, and peroxidases.

The peroxides that are formed by radical damage to lipids in membranes and plasma lipoproteins are reduced to hydroxy fatty acids by glutathione peroxidase, a selenium-dependent enzyme (hence the importance of adequate selenium intake to maximize antioxidant activity), and the oxidized glutathione is reduced by NADPH-dependent glutathione reductase (see [Figure 20–3](#)). Lipid peroxides are also reduced to fatty acids by reaction with vitamin E, forming the tocopheroxyl radical, which is relatively stable, since the unpaired electron can be located in any one of three positions in the molecule ([Figure 45–3](#)). The tocopheroxyl radical persists long enough to undergo reduction back to tocopherol by reaction with vitamin C at the surface of the cell or lipoprotein. The resultant monodehydroascorbate radical then undergoes enzymic reduction back to ascorbate or a nonenzymic reaction of 2 mol of monodehydroascorbate to yield 1 mol each of ascorbate and dehydroascorbate.

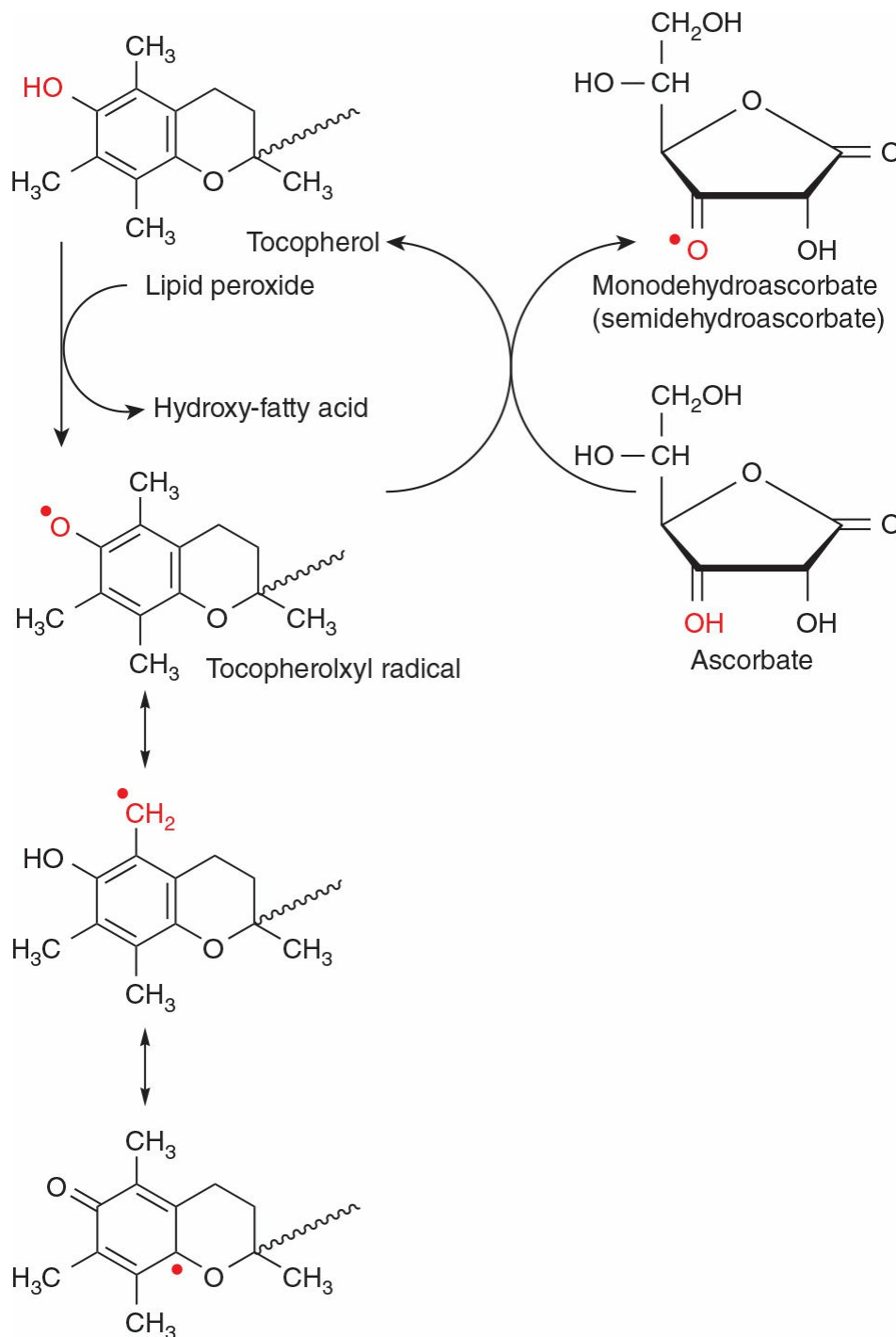

FIGURE 45–3 The roles of vitamins E and C in reducing lipid peroxides, and stabilization of the tocopheroxyl radical by delocalization of the unpaired electron.

Ascorbate, uric acid, and a variety of polyphenols derived from plant foods act as water-soluble radical-trapping antioxidants, forming relatively stable radicals that persist long enough to undergo reaction to nonradical products. Ubiquinone and carotenes similarly act as lipid-soluble radical-trapping antioxidants in membranes and plasma lipoproteins.

The Antioxidant Paradox—Antioxidants Can Also Be Pro-Oxidants

Although ascorbate is an antioxidant, reacting with superoxide and hydroxyl to yield monodehydroascorbate and hydrogen peroxide or water, it can also be a source of superoxide radicals by reaction with oxygen, and hydroxyl radicals by reaction with Cu^{2+} ions (Table 45–1). However, these pro-oxidant actions require relatively high concentrations of ascorbate, which are unlikely to be reached in tissues, since once the plasma concentration of ascorbate reaches about 30 mmol/L, the renal threshold is reached, and at intakes above about 100 to 120 mg/d the vitamin is excreted in the urine quantitatively with intake.

TABLE 45–1 Antioxidant and Pro-Oxidant Roles of Vitamin C

<p>Antioxidant roles:</p> <p>Ascorbate + $\cdot\text{O}_2^- \rightarrow \text{H}_2\text{O}_2$ + monodehydroascorbate; catalase and peroxidases catalyze the reaction: $2\text{H}_2\text{O}_2 \rightarrow 2\text{H}_2\text{O} + \text{O}_2$</p> <p>Ascorbate + $\cdot\text{OH} \rightarrow \text{H}_2\text{O}$ + monodehydroascorbate</p>
<p>Pro-oxidant roles:</p> <p>Ascorbate + $\text{O}_2 \rightarrow \cdot\text{O}_2^-$ + monodehydroascorbate</p> <p>Ascorbate + $\text{Cu}^{2+} \rightarrow \text{Cu}^+$ + monodehydroascorbate</p> <p>$\text{Cu}^+ + \text{H}_2\text{O}_2 \rightarrow \text{Cu}^{2+} + \text{OH}^- + \cdot\text{OH}$</p>

A considerable body of epidemiological evidence suggests that carotene is protective against lung and other cancers. However, two major intervention trials in the 1990s showed an increase in death from lung (and other) cancer among people who were given supplements of β -carotene. The problem is that although β -carotene is indeed a radical-trapping antioxidant under conditions of low partial pressure of oxygen, as in most tissues, at high partial pressures of oxygen (as in the lungs) and especially in high concentrations, β -carotene is an autocatalytic pro-oxidant, and hence can initiate radical damage to lipids and proteins.

Epidemiological evidence also suggests that vitamin E is protective against atherosclerosis and cardiovascular disease. However, meta-analysis of intervention trials with vitamin E shows increased mortality among those taking (high dose) supplements. These trials have all used α -tocopherol, and it is possible that the other vitamers of vitamin E that are

present in foods, but not the supplements, may be important. In vitro, plasma lipoproteins form less cholesterol ester hydroperoxide when incubated with sources of low concentrations of perhydroxyl radicals when vitamin E has been removed than when it is present. The problem seems to be that vitamin E acts as an antioxidant by forming a stable radical that persists long enough to undergo metabolism to nonradical products. This means that the radical also persists long enough to penetrate deeper in to the lipoprotein, causing further radical damage, rather than interacting with a water-soluble antioxidant at the surface of the lipoprotein.

Nitric oxide and other radicals are important in cell signaling, and especially in signaling for programmed cell death (apoptosis) of cells that have suffered DNA and other damage. It is likely that high concentrations of antioxidants, so far from protecting against tissue damage, may quench the signaling radicals, and so permit the continued survival of damaged cells, so increasing, rather than decreasing, the risk of cancer development.

SUMMARY

- Free radicals are highly reactive molecular species with an unpaired electron. They can react with, and modify, proteins, nucleic acids, and fatty acids in cell membranes and plasma lipoproteins.
- Radical damage to lipids and proteins in plasma lipoproteins is a factor in the development of atherosclerosis and coronary artery disease; radical damage to nucleic acids may induce heritable mutations and cancer; radical damage to proteins may lead to the development of autoimmune diseases.
- Oxygen radicals arise as a result of exposure to ionizing radiation, nonenzymic reactions of transition metal ions, the respiratory burst of activated macrophages, and the normal oxidation of reduced flavin coenzymes.
- Protection against radical damage is afforded by enzymes that remove superoxide ions and hydrogen peroxide, enzymic reduction of lipid peroxides linked to oxidation of glutathione, nonenzymic reaction of lipid peroxides with vitamin E, and reaction of radicals with compounds such as vitamins C and E, carotene, ubiquinone, uric acid, and dietary polyphenols that form relatively stable radicals that persist long enough to undergo reaction to nonradical products.
- Except in people who were initially deficient, intervention trials of vitamin E and β -carotene have generally shown increased mortality among those taking the supplements. β -Carotene is only an

antioxidant at low concentrations of oxygen; at higher concentrations of oxygen it is an autocatalytic pro-oxidant. Vitamin E forms a stable radical that is capable of either undergoing reaction with water-soluble antioxidants or penetrating further into lipoproteins and tissues, so increasing radical damage.

- Radicals are important in cell signaling, and especially in signaling for apoptosis of cells that have suffered DNA damage. It is likely that high concentrations of antioxidants, so far from protecting against tissue damage, may quench the signaling radicals, and so permit the continued survival of damaged cells, so increasing, rather than decreasing, the risk of cancer development.

Glycoproteins

David A. Bender, PhD & Robert K. Murray, MD, PhD

OBJECTIVES

After studying this chapter, you should be able to:

- Explain the importance of glycoproteins in health and disease.
- Describe the principal sugars found in glycoproteins.
- Describe the major classes of glycoproteins (*N*-linked, *O*-linked, and GPI-linked).
- Describe the major features of the pathways of biosynthesis and degradation of glycoproteins.
- Explain how many microorganisms, such as influenza virus, attach to cell surfaces via sugar chains.

BIOMEDICAL IMPORTANCE

The **glycoproteins** are proteins that contain oligosaccharide chains (glycans) covalently bound to amino acids; **glycosylation** (the enzymic attachment of sugars) is the most frequent posttranslational modification of proteins. Many proteins also undergo reversible glycosylation with a single sugar (*N*-acetylglucosamine) bound to a serine or threonine residue that is

also a site for reversible phosphorylation. This is an important mechanism of metabolic regulation. Nonenzymic attachment of sugars to proteins can also occur, and is referred to as **glycation**. This process can have serious pathologic consequences (eg, in poorly controlled diabetes mellitus).

Glycoproteins are one class of **glycoconjugate** or **complex carbohydrate**—molecules containing one or more carbohydrate chains covalently linked to protein (to form **glycoproteins** or **proteoglycans**, see [Chapter 50](#)) or lipid (to form **glycolipids**, see [Chapter 21](#)). Almost all **plasma proteins**, and many **peptide hormones**, are glycoproteins, as are a number of **blood group substances** (others are glycosphingolipids). Many **cell membrane proteins** (see [Chapter 40](#)) contain substantial amounts of carbohydrate, and many are anchored to the lipid bilayer by a glycan chain. Evidence is accumulating that alterations in the structures of glycoproteins and other glycoconjugates on the surface of cancer cells are important in metastasis.

GLYCOPROTEINS OCCUR WIDELY & PERFORM NUMEROUS FUNCTIONS

Glycoproteins occur in most organisms, from bacteria to human beings. Many viruses also contain glycoproteins, some of which play key roles in viral attachment to host cells. The glycoproteins have a wide range of functions ([Table 46–1](#)); their carbohydrate content ranges from 1 to over 85% by weight. The glycan structures of glycoproteins change in response to signals involved in cell differentiation, normal physiology, and neoplastic transformation. This is the result of different expression patterns of glycosyltransferases. [Table 46–2](#) lists some of the major functions of the glycan chains of glycoproteins.

TABLE 46–1 Some Functions Served by Glycoproteins

Function	Glycoproteins
Structural molecule	Collagens
Lubricant and protective agent	Mucins
Transport molecule	Transferrin, ceruloplasmin
Immunological molecule	Immunoglobulins, histocompatibility antigens
Hormone	Chorionic gonadotropin, thyroid-stimulating hormone (TSH)
Enzyme	Various, eg, alkaline phosphatase
Cell attachment–recognition site	Various proteins involved in cell–cell (eg, sperm–oocyte), virus–cell, bacterium–cell, and hormone–cell interactions
Antifreeze	Plasma proteins of cold-water fish
Interact with specific carbohydrates	Lectins, selectins (cell adhesion lectins), antibodies
Receptor	Cell surface proteins involved in hormone and drug action
Regulate folding of proteins that are exported from the cell	Calnexin, calreticulin
Regulation of differentiation and development	Notch and its analogs, key proteins in development
Hemostasis (and thrombosis)	Specific glycoproteins on the surface membranes of platelets

TABLE 46–2 Some Functions of the Oligosaccharide Chains of Glycoproteins

- Change physicochemical properties of the protein such as solubility, viscosity, charge, conformation, denaturation.
- Provide binding sites for various molecules, as well as bacteria, viruses, and some parasites.
- Provide cell surface recognition signals.
- Protect against proteolysis.
- Ensure correct folding of proteins that are exported from the cell and target incorrectly folded proteins for transport from the endoplasmic reticulum back to the cytosol for catabolism.
- Protect peptide hormones and other plasma proteins against clearance by the liver.
- Permit anchoring of extracellular proteins in the cell membrane, and of intracellular proteins inside subcellular organelles such as endoplasmic reticulum and Golgi.
- Direct intracellular migration, sorting and secretion of proteins.
- Affect embryonic development and cell and tissue differentiation.
- May affect sites of metastases selected by cancer cells.

OLIGOSACCHARIDE CHAINS ENCODE BIOLOGICAL INFORMATION

The biological information in the sequence and linkages of sugars in glycans differs from that in DNA, RNA, and proteins in one important respect; it is secondary rather than primary information. The pattern of glycosylation of a given protein depends on the pattern of expression of the various **glycosyltransferases** in the cell that are involved in glycoprotein synthesis, the affinity of the different glycosyltransferases for their carbohydrate substrates, and the relative availability of the different carbohydrate substrates. Because of this there is **microheterogeneity** of glycoproteins, something that complicates their analysis. Not all of the glycan chains of a given glycoprotein are complete; some are truncated.

The information from the sugars is expressed via interactions between the glycans and proteins such as **lectins** (see below) or other molecules. These interactions lead to changes in cellular activity.

EIGHT SUGARS PREDOMINATE IN HUMAN GLYCOPROTEINS

Only eight monosaccharides are commonly found in glycoproteins (**Table 46–3** and **Chapter 15**). *N*-acetylneuraminic acid (NeuAc) is usually found at the termini of oligosaccharide chains, attached to subterminal galactose

(Gal) or *N*-acetylgalactosamine (GalNAc) residues. The other sugars are usually found in more internal positions. **Sulfate** is often found in glycoproteins, usually attached to galactose, *N*-acetylglucosamine, or *N*-acetylgalactosamine.

TABLE 46–3 The Principal Sugars Found in Human Glycoproteins^a

Sugar	Type	Abbreviation	Sugar Nucleotide	Comments
Galactose	Hexose	Gal	UDP-Gal	Often found subterminal to NeuAc in <i>N</i> -linked glycoproteins. Also, found in the core trisaccharide of proteoglycans.
Glucose	Hexose	Glc	UDP-Glc	Present during the biosynthesis of <i>N</i> -linked glycoproteins but not usually present in mature glycoproteins. Present in some clotting factors.
Mannose	Hexose	Man	GDP-Man	Common sugar in <i>N</i> -linked glycoproteins.
<i>N</i> -Acetylneuraminic acid	Sialic acid (nine C atoms)	NeuAc	CMP-NeuAc	Often the terminal sugar in both <i>N</i> - and <i>O</i> -linked glycoproteins. Other types of sialic acid are also found, but NeuAc is the major species found in humans. Acetyl groups may also occur as <i>O</i> -acetyl species as well as <i>N</i> -acetyl.
Fucose	Deoxyhexose	Fuc	GDP-Fuc	May be external in both <i>N</i> - and <i>O</i> -linked glycoproteins or internal, linked to the GlcNAc residue attached to Asn in <i>N</i> -linked species. Can also occur internally attached to the OH of Ser (eg, in t-PA and certain clotting factors).
<i>N</i> -Acetylgalactosamine	Aminohexose	GalNAc	UDP-GalNAc	Present in both <i>N</i> - and <i>O</i> -linked glycoproteins.
<i>N</i> -Acetylglucosamine	Aminohexose	GlcNAc	UDP-GlcNAc	The sugar attached to the polypeptide chain via Asn in <i>N</i> -linked glycoproteins; also found at other sites in the oligosaccharides of these proteins. Many nuclear proteins have GlcNAc attached to the OH of Ser or Thr as a single sugar.
Xylose	Pentose	Xyl	UDP-Xyl	Xyl is attached to the OH of Ser in many proteoglycans. Xyl in turn is attached to two Gal residues, forming a link trisaccharide. Xyl is also found in t-PA and certain clotting factors.

^aThe structures of these sugars are illustrated in Chapter 15.

As in most biosynthetic reactions, it is not the free or phosphorylated sugar that is the substrate for glycoprotein synthesis, but the corresponding **sugar nucleotide** (see [Figure 18–2](#)); some contain UDP and others guanosine diphosphate (GDP) or cytidine monophosphate (CMP).

LECTINS CAN BE USED TO PURIFY GLYCOPROTEINS & TO INVESTIGATE THEIR FUNCTIONS

Lectins are **carbohydrate-binding proteins** that agglutinate cells or precipitate glycoconjugates; a number of lectins are themselves glycoproteins. Immunoglobulins that react with sugars are not considered to be lectins. Lectins contain at least two sugar-binding sites; proteins with only a single sugar-binding site will not agglutinate cells or precipitate glycoconjugates.

Lectins were first discovered in plants and microorganisms, but many lectins of animal origin are now known, including the mammalian **asialoglycoprotein receptor**. Many peptide hormones, and most plasma proteins are glycoproteins. Treatment of the protein with neuraminidase removes the terminal *N*-acetylneuraminic acid moiety, exposing the subterminal galactose residue. This asialoglycoprotein is cleared from the circulation very much faster than the intact glycoprotein. Liver cells contain an asialoglycoprotein receptor that recognizes the galactose moiety of many desialylated plasma proteins, leading to their endocytosis and catabolism.

Plant lectins were formerly called **phytohemagglutinins**, because of their ability to agglutinate red blood cells by reacting with the cell surface glycoproteins. Undenatured lectins in undercooked legumes can lead to stripping of the intestinal mucosa by agglutinating the mucosal cells.

Lectins are used to purify glycoproteins, as tools for probing the glycoprotein profiles of cell surfaces, and as reagents for generating mutant cells deficient in certain enzymes involved in the biosynthesis of oligosaccharide chains.

THERE ARE THREE MAJOR CLASSES OF GLYCOPROTEINS

Glycoproteins can be divided into three main groups, based on the nature of the linkage between the polypeptide and oligosaccharide chains (**Figure 46-1**); there are other minor classes of glycoprotein:

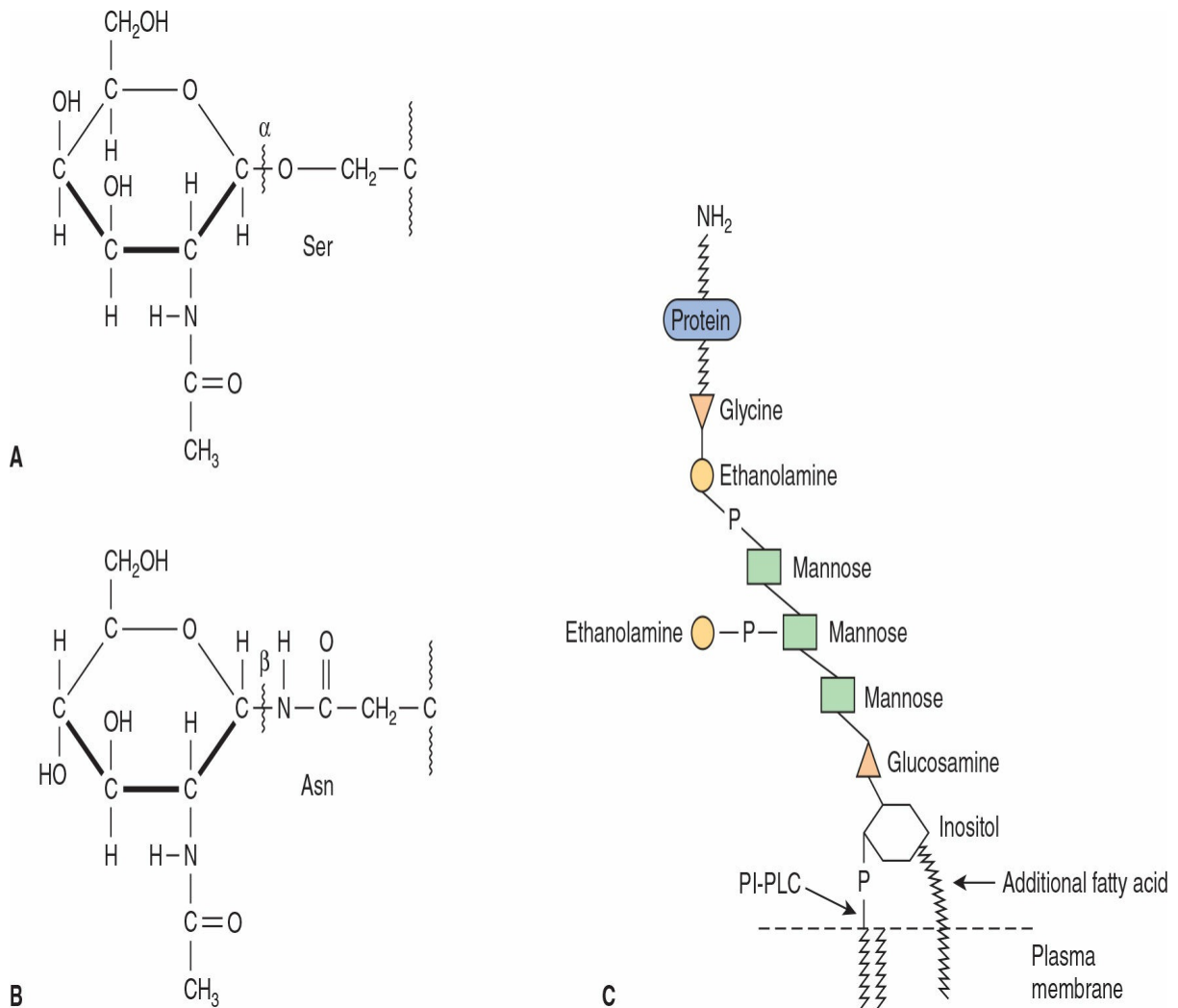

FIGURE 46–1 The three main types of glycoprotein: (A) an **O-linkage** (*N*-acetylgalactosamine to serine), (B) an **N-linkage** (*N*-acetylglucosamine to asparagine), and (C) a **glycosylphosphatidylinositol (GPI) linkage**. The GPI structure shown is that linking acetylcholinesterase to the plasma membrane of the human red blood cell. The site of action of PI-phospholipase C (PI-PLC), which releases the enzyme from membrane binding is indicated. This particular GPI contains an extra fatty acid attached to inositol and also an extra phosphoryl-ethanolamine moiety attached to the central of the mannose residue. Variations found among different GPI structures include the identity of the carboxyl-terminal amino acid, the molecules attached to the mannose residues, and the precise nature of the lipid moiety.

1. Those containing an **O-glycosidic linkage** (*O*-linked), involving the hydroxyl side chain of serine or threonine (and sometimes also tyrosine) and a sugar such as *N*-acetylgalactosamine (GalNAc-Ser[Thr]).

2. Those containing an ***N*-glycosidic linkage** (*N*-linked), involving the amide nitrogen of asparagine and *N*-acetylglucosamine (GlcNAc-Asn).
3. Those linked to the carboxyl-terminal amino acid of a protein via a phosphorylethanolamine moiety joined to an oligosaccharide (glycan), which in turn is linked via glucosamine to phosphatidylinositol (PI). These are **glycosylphosphatidylinositol-anchored (GPI-anchored)** glycoproteins. Among other functions, they are involved in directing glycoproteins to the apical or basolateral areas of the plasma membrane of polarized epithelial cells (see [Chapter 40](#) and below).

The number of oligosaccharide chains attached to one protein can vary from 1 to 30 or more, with the sugar chains ranging from one or two residues in length to much larger structures. The glycan chain may be linear or branched. Many proteins contain more than one type of sugar chain; for instance, **glycophorin**, an important red cell membrane glycoprotein (see [Chapter 53](#)), contains both *O*- and *N*-linked oligosaccharides.

GLYCOPROTEINS CONTAIN SEVERAL TYPES OF *O*-GLYCOSIDIC LINKAGES

At least four subclasses of *O*-glycosidic linkages are found in human glycoproteins:

1. The ***N*-acetylgalactosamine-Ser(Thr)** linkage shown in [Figure 46–1](#) is the predominant linkage. Usually a galactose or an *N*-acetylneuraminic acid residue is attached to the *N*-acetylgalactosamine, but many variations in the sugar compositions and lengths of such oligosaccharide chains are found. This type of linkage is found in **mucins** (see below).
2. **Proteoglycans** contain a galactose-galactose-xylose trisaccharide (the so-called link trisaccharide) attached to serine.
3. **Collagens** (see [Chapter 50](#)) contain a **galactose-hydroxylysine** linkage.
4. Many **nuclear and cytosolic proteins** contain side chains consisting of a single *N*-acetylglucosamine attached to a serine or threonine residue.

Mucins Have a High Content of *O*-Linked

Oligosaccharides & Exhibit Repeating Amino Acid Sequences

Mucins are glycoproteins that are highly resistant to proteolysis because the density of oligosaccharide chains makes it difficult for **proteases** to access the polypeptide chain. They help to **lubricate** and form a **protective physical barrier** on epithelial surfaces.

Mucins have two distinctive characteristics: a high content of **O-linked oligosaccharides** (the carbohydrate content is generally more than 50%); and the presence of **variable numbers of tandem repeats (VNTRs)** of peptide sequence in the center of the polypeptide chain, to which the *O*-glycan chains are attached in clusters. These tandem repeat sequences are rich in serine, threonine, and proline; indeed, up to 60% of the dietary requirement for threonine can be accounted for by the synthesis of mucins. Although *O*-glycans predominate, mucins often also contain a number of *N*-glycan chains.

Both **secretory** and **membrane-bound** mucins occur. **Mucus** secreted by the gastrointestinal, respiratory, and reproductive tracts is a solution containing about 5% mucins. Secretory mucins generally have an oligomeric structure, with monomers linked by disulfide bonds, and hence a very high molecular mass. Mucus has a high viscosity and often forms a gel because of its content of mucins. The high content of *O*-glycans confers an extended structure. This is partly explained by steric interactions between the *N*-acetylgalactosamine moieties and adjacent amino acids, resulting in a chain-stiffening effect, so that the conformation of mucins often become rigid rods. Intermolecular noncovalent interactions between sugars on neighboring glycan chains contribute to gel formation. The high content of ***N*-acetylneuraminic acid** and **sulfate** residues found in many mucins gives them a negative charge.

Membrane-bound mucins participate in **cell–cell interactions**, and may also mask cell surface antigens. Many cancer cells form large amounts of mucins that mask surface antigens and protect the cancer cells from immune surveillance. Mucins also carry cancer-specific peptide and carbohydrate epitopes. Some of these have been used to stimulate an immune response against cancer cells.

O-Linked Glycoproteins Are Synthesized by Sequential Addition of Sugars from Sugar Nucleotides

Because most glycoproteins are membrane-bound or secreted, their mRNA is usually translated on membrane-bound polyribosomes (see [Chapter 37](#)). The glycan chains are built up by the sequential donation of sugars from sugar nucleotides, catalyzed by **glycoprotein glycosyltransferases**. Because many glycosylation reactions occur within the lumen of the Golgi apparatus, there are **carrier systems** (permeases and transporters) to transport sugar nucleotides (UDP-galactose, GDP-mannose, and CMP-*N*-acetylneuraminic acid) across the Golgi membrane. They are **antiporter** systems; the influx of one molecule of sugar nucleotide is balanced by the efflux of one molecule of the corresponding nucleotide (UMP, GMP, or CMP).

There are 41 different types of glycoprotein glycosyltransferases. Families of glycosyltransferases are named for the sugar nucleotide donor, and subfamilies on the basis of the linkage formed between the sugar and the acceptor substrate; transfer may occur with retention or inversion of the conformation at C-1 of the sugar. Binding of the sugar nucleotide to the enzyme causes a conformational change in the enzyme that permits binding of the acceptor substrate. Glycosyltransferases show a high degree of specificity for the acceptor substrate, typically acting only on the product of the preceding reaction. The different stages in glycan formation, and hence the different glycosyltransferases, are located in different regions of the Golgi, so that there is spatial separation of the steps in the process. Not all of the glycan chains of a given glycoprotein are complete; some are truncated, leading to microheterogeneity. No consensus sequence is known to determine which serine and threonine residues are glycosylated, but the first sugar moiety incorporated is usually *N*-acetylgalactosamine.

***N*-LINKED GLYCOPROTEINS CONTAIN AN ASPARAGINE-*N*-ACETYLGLUCOSAMINE LINKAGE**

N-Linked glycoproteins are the major class of glycoproteins, including both **membrane-bound** and **circulating** glycoproteins. They are distinguished by the presence of the asparagine—*N*-acetylglucosamine linkage ([Figure 46–1](#)). There are three major classes of *N*-linked oligosaccharides: **complex**, **high-mannose**, and **hybrid**. All three classes have the same branched pentasaccharide, $\text{Man}_3\text{GlcNAc}_2$, bound to asparagine, but differ in their outer branches ([Figure 46–2](#)).

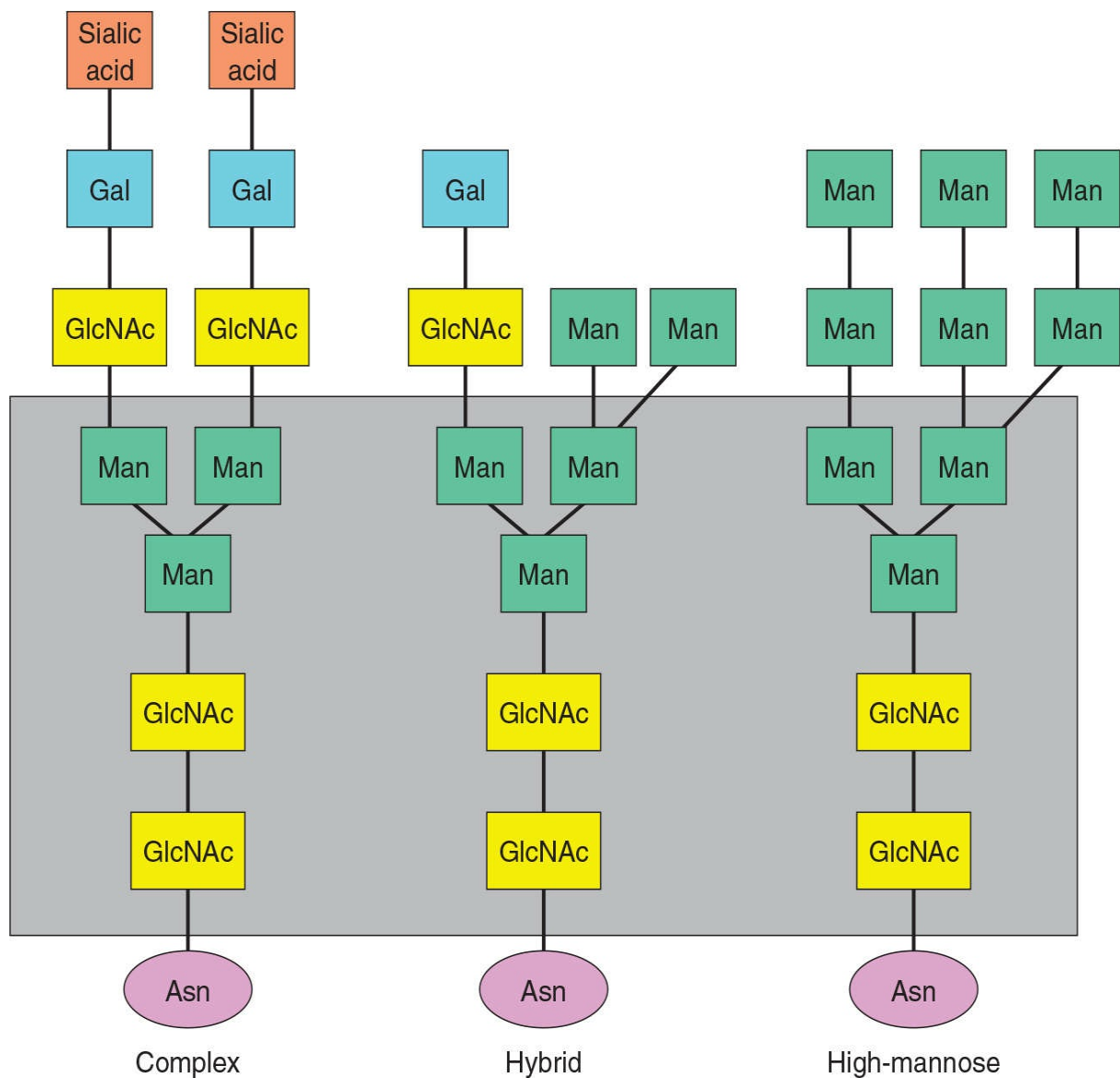

FIGURE 46–2 Structures of the major types of asparagine-linked oligosaccharides. The boxed area encloses the pentasaccharide core common to all *N*-linked glycoproteins.

Complex oligosaccharides contain two, three, four, or five outer branches. The oligosaccharide branches are often referred to as **antennae**, so that bi-, tri-, tetra-, and penta-antennary structures may all be found. They generally contain terminal *N*-acetylneuraminic acid residues and underlying galactose and *N*-acetylglucosamine residues, the latter often constituting the disaccharide *N*-acetylglucosamine. Repeating ***N*-acetylglucosamine units**—[Gal β 1–3/4GlcNAc β 1–3] $_n$ (poly-*N*-acetylglucosaminoglycans)—are often found on *N*-linked glycan chains. *I/i* blood group substances belong to this class. A bewildering number of chains of the complex type exist, and that indicated in [Figure 46–2](#) is only

one of many. Other complex chains may terminate in galactose or fucose.

High-mannose oligosaccharides typically have two to six additional mannose residues linked to the pentasaccharide core. Hybrid molecules contain features of both of the other classes.

The Biosynthesis of *N*-Linked Glycoproteins Involves Dolichol-P-P-Oligosaccharide

The synthesis of all *N*-linked glycoproteins begins with the synthesis of a branched oligosaccharide attached to **dolichol pyrophosphate (Figure 46-3)** on the cytosolic side of the endoplasmic reticulum membrane, which is then translocated to the lumen of the endoplasmic reticulum, where it undergoes further glycosylation, before the oligosaccharide chain is transferred by an oligosaccharyltransferase onto an asparagine residue of the acceptor apoglycoprotein as it enters the endoplasmic reticulum during synthesis on membrane-bound polyribosomes. This is thus a cotranslational modification. In many of the *N*-linked glycoproteins there is a consensus sequence of Asn-X-Ser/Thr (where X = any amino acid other than proline) to determine the site of glycosylation; in others there is no clear consensus sequence for glycosylation.

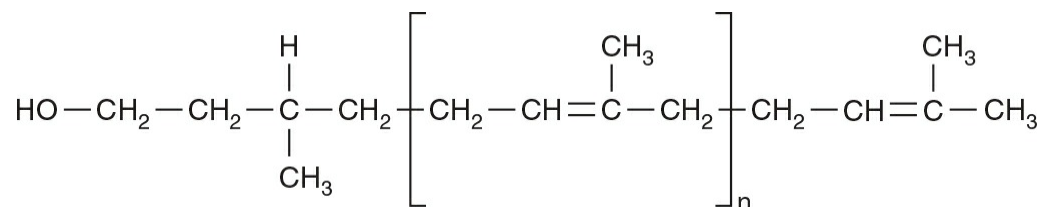

FIGURE 46-3 The structure of dolichol. The group within the brackets is an isoprene unit ($n = 17-20$ isoprenoid units).

As shown in **Figure 46-4**, the first step is a reaction between UDP-*N*-acetylglucosamine and dolichol phosphate, forming *N*-acetylglucosamine dolichol pyrophosphate. A second *N*-acetylglucosamine is added from UDP-*N*-acetylglucosamine, followed by the addition of five molecules of mannose from GDP-mannose. The dolichol pyrophosphate oligosaccharide is then translocated into the lumen of the endoplasmic reticulum, and further mannose and glucose molecules are added, to form the final dolichol pyrophosphate oligosaccharide, using dolichol phosphate mannose and dolichol phosphate glucose as the donors. The dolichol pyrophosphate oligosaccharide is then transferred onto the acceptor asparagine residue of the nascent protein chain.

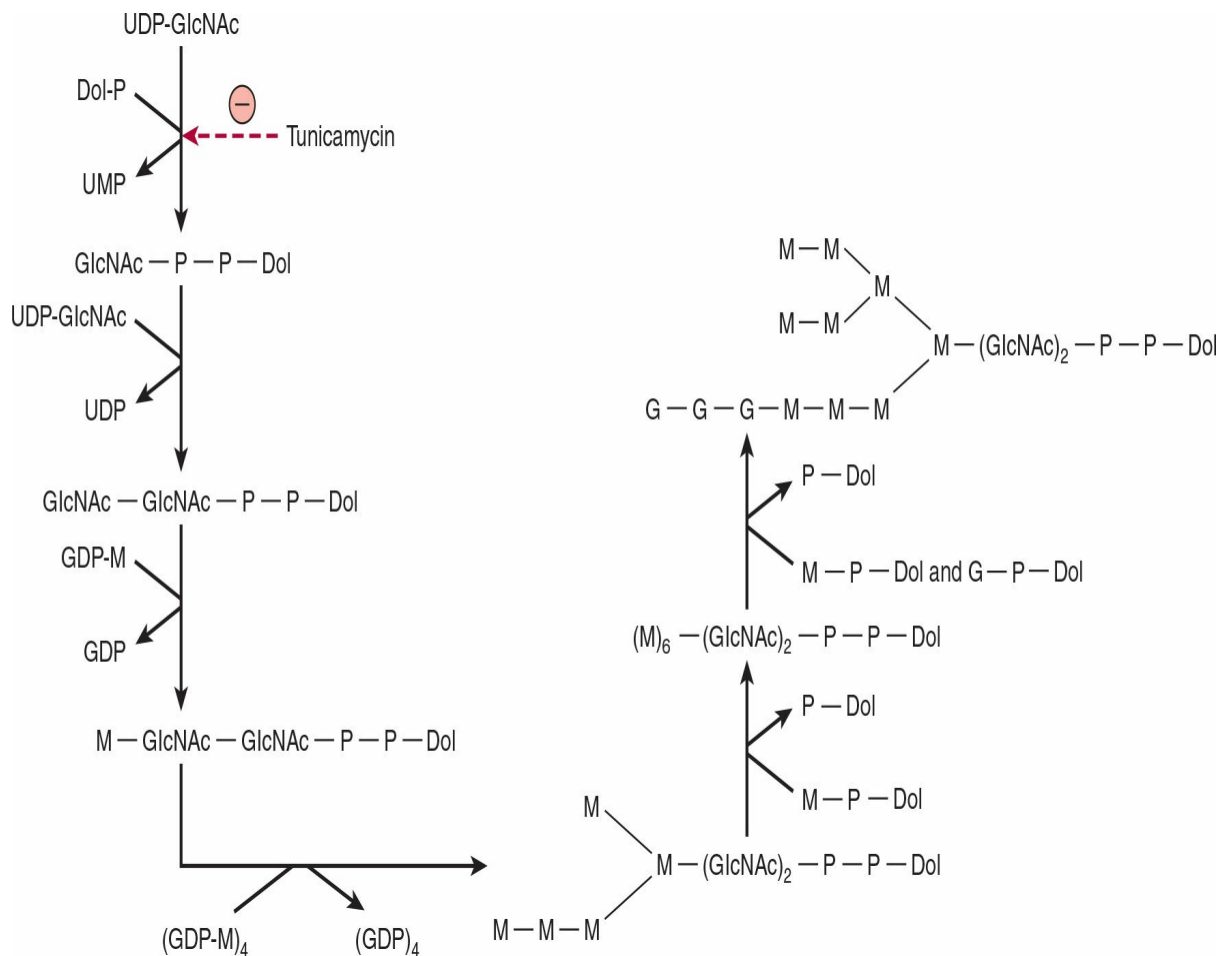

FIGURE 46–4 Pathway of biosynthesis of dolichol pyrophosphate oligosaccharide. Note that the first five internal mannose residues are donated by GDP-mannose, whereas the more external mannose residues and the glucose residues are donated by dolichol-P-mannose and dolichol-P-glucose. (Dol, dolichol; GDP, guanosine diphosphate; P, phosphate; UDP, uridine diphosphate; UMP, uridine monophosphate.)

To form **high-mannose** chains, the glucose and some of the peripheral mannose residues are removed by glycosidases. To form an oligosaccharide chain of the **complex type**, the glucose residues and four of the mannose residues are removed by glycosidases in the endoplasmic reticulum and Golgi, then *N*-acetylglucosamine, galactose, and *N*-acetylneuraminic acid are added in reactions catalyzed by glycosyltransferases in the Golgi apparatus. **Hybrid chains** are formed by partial processing, forming complex chains on one arm and mannose units on the other arm.

Glycoproteins & Calnexin Ensure Correct Folding of

Proteins in the Endoplasmic Reticulum

Calnexin is a chaperone protein in the endoplasmic reticulum membrane; binding to calnexin prevents a glycoprotein from aggregating. It is a lectin, recognizing specific carbohydrate sequences in the glycan chain of the glycoprotein. Incorrectly folded glycoproteins undergo partial deglycosylation, and are targeted to undergo transport from the endoplasmic reticulum back to the cytosol for catabolism.

Calnexin binds to glycoproteins that possess a monoglycosylated core from which the terminal glucose residue has been removed, leaving only the innermost glucose attached. Calnexin and the bound glycoprotein form a complex with **ERp57**, a homolog of protein disulfide isomerase, which catalyzes disulfide bond interchange, facilitating correct folding. The bound glycoprotein is released from its complex with calnexin-ERp57 when the sole remaining glucose is hydrolyzed by a glucosidase and is then available for secretion if it is correctly folded. If not, a **glucosyltransferase** recognizes this and reglycosylates the glycoprotein, which rebinds to the calnexin-ERp57 complex. If it is now correctly folded, the glycoprotein is again deglycosylated and secreted. If it is not capable of correct folding, it is translocated out of the endoplasmic reticulum into the cytosol for catabolism. The glucosyltransferase senses the folding of the glycoprotein and only reglycosylates misfolded proteins. The soluble endoplasmic reticulum protein **calreticulin** performs a similar function to that of calnexin.

Several Factors Regulate the Glycosylation of Glycoproteins

The glycosylation of glycoproteins involves a large number of enzymes; about 1% of the human genome codes for genes that are involved with protein glycosylation. There are at least 10 distinct *N*-acetylglucosamine transferases, and multiple isoenzymes of the other glycosyltransferases. Controlling factors in the first stage of *N*-linked glycoprotein biosynthesis (assembly and transfer of the dolichol pyrophosphate oligosaccharide) include not only the availability of the sugar nucleotides, but also the presence of suitable acceptor sites in proteins, the tissue concentration of dolichol phosphate, and the activity of the oligosaccharide: protein transferase.

Various **cancer cells** are found to synthesize different oligosaccharide chains from those made in normal cells (eg, greater branching). This is due

to cancer cells expressing different patterns of glycosyltransferases from those in normal cells, as a result of specific gene activation or repression. The differences in oligosaccharide chains could affect adhesive interactions between cancer cells and the normal parent tissue cells, contributing to metastasis.

SOME PROTEINS ARE ANCHORED TO THE PLASMA MEMBRANE BY GLYCOPHOSPHATIDYL-INOSITOL STRUCTURES

Membrane-bound proteins that are anchored to the lipid bilayer by a glycoposphatidylinositol (GPI) tail (Figure 46–1) constitute the third major class of glycoproteins. GPI linkage is the commonest way in which various proteins are anchored to cell membranes.

The proteins are anchored to the outer leaflet of the plasma membrane or the inner (luminal) leaflet of the membrane in secretory vesicles by the fatty acids of phosphatidylinositol. The phosphatidylinositol is linked via *N*-acetylglucosamine to a glycan chain containing a variety of sugars, including mannose and glucosamine. In turn, the oligosaccharide chain is linked via phosphorylethanolamine in an amide linkage to the carboxyl-terminal amino acid of the protein. Additional constituents are found in many GPI structures; for example, that shown in Figure 46–1 contains an extra phosphorylethanolamine attached to the middle of the three mannose moieties of the glycan and an extra fatty acid attached to glucosamine.

There are three functions of this GPI linkage:

1. The GPI anchor allows greatly enhanced **mobility** of a protein in the plasma membrane compared with that of a protein that contains transmembrane sequences. The GPI anchor is attached only to the outer leaflet of the lipid bilayer, so that it is freer to diffuse than a protein anchored through both layers of the membrane. Increased mobility may be important in facilitating rapid responses to stimuli.
2. Some GPI anchors may connect with **signal transduction** pathways, so that proteins that do not have a transmembrane domain may nevertheless be receptors for hormones and other cell surface signals.
3. GPI structures can **target** proteins to apical or basolateral domains of the plasma membrane of polarized epithelial cells.

The GPI anchor is preformed in the endoplasmic reticulum, and is then attached to the protein after ribosomal synthesis is complete. The primary translation products of GPI-anchored proteins have not only an amino-terminal signal sequence that directs them into the endoplasmic reticulum during synthesis, but also a carboxy-terminal hydrophobic domain that acts as the signal for attachment of the GPI anchor. The first stage in synthesis of the GPI anchor is insertion of the fatty acids of phosphatidylinositol into the luminal face of the endoplasmic reticulum membrane, followed by glycosylation, starting with esterification of *N*-acetyl-glucosamine to the phosphate group of phosphatidylinositol. A terminal phosphoethanolamine moiety is added to the completed glycan chain. The hydrophobic carboxy-terminal domain of the protein is displaced by the amino group of ethanolamine in the transamidation reaction that forms the amide linkage between the GPI anchor and an aspartate residue in the protein.

SOME PROTEINS UNDERGO RAPIDLY REVERSIBLE GLYCOSYLATION

Many proteins, including nuclear pore proteins, proteins of the cytoskeleton, transcription factors, and proteins associated with chromatin, as well as nuclear oncogene proteins and tumor suppressor proteins, undergo rapidly reversible *O*-glycosylation with a single sugar moiety, *N*-acetylglucosamine. The serine and threonine sites of glycosylation are the same as those of phosphorylation of these proteins, and glycosylation and phosphorylation occur reciprocally in response to cellular signaling.

The *O*-linked *N*-acetylglucosamine transferase that catalyzes this glycosylation uses UDP-*N*-acetylglucosamine as the sugar donor, and has phosphatase activity, so can directly replace a serine or threonine phosphate with *N*-acetylglucosamine. There is no absolute consensus sequence for the reaction, but about half the sites that are subject to reciprocal glycosylation and phosphorylation are Pro-Val-Ser. *O*-linked *N*-acetylglucosamine transferase is activated by phosphorylation in response to insulin action, and the *N*-acetylglucosamine is removed by *N*-acetylglucosaminidase, leaving the site available for phosphorylation.

Both the activity and peptide specificity of *O*-linked *N*-acetylglucosamine transferase depend on the concentration of UDP-*N*-acetylglucosamine. Depending on cell type, up to 2 to 5% of glucose metabolism is by way of the hexosamine pathway leading to *N*-acetylglucosamine formation, giving the *O*-linked *N*-acetylglucosamine transferase a role in nutrient sensing in the cell. Excessive *O*-glycosylation

with *N*-acetylglucosamine (and hence reduced phosphorylation) of target proteins is implicated in **insulin resistance** and glucose toxicity in **diabetes mellitus**, as well as neurodegenerative diseases.

ADVANCED GLYCATION END-PRODUCTS (AGEs) ARE IMPORTANT IN CAUSING TISSUE DAMAGE IN DIABETES MELLITUS

Glycation is the nonenzymic attachment of sugars (mainly glucose) to amino groups of proteins (and also to other molecules including DNA and lipids), unlike **glycosylation** which is enzyme-catalyzed. Initially, glucose forms a **Schiff base** to the amino terminal of the protein, which then undergoes the **Amadori rearrangement** to yield **ketoamines** (**Figure 46–5**), and further reactions to yield **advanced glycation end-products (AGEs)**. The overall series of reactions is known as the **Maillard reaction**, which is involved in the **browning** of certain foodstuffs during storage or heating, and provides much of the flavor of some foods.

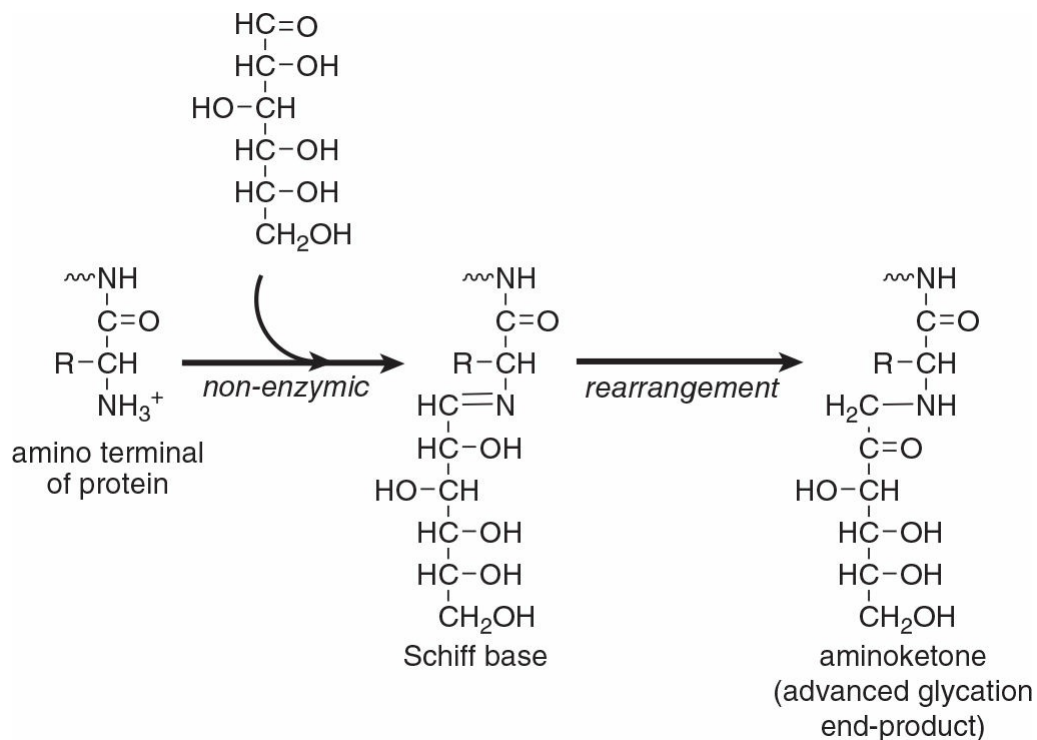

FIGURE 46–5 Formation of advanced glycation end-products from glucose.

Advanced glycation end-products underlie **tissue damage** in poorly controlled **diabetes mellitus**. When the blood glucose concentration is

consistently elevated, there is increased glycation of proteins. Glycation of collagen and other proteins in the extracellular matrix alters their properties (eg, increasing the **cross-linking of collagen**). Cross-linking can lead to accumulation of various plasma proteins in the walls of blood vessels; in particular, accumulation of low-density lipoprotein (**LDL**) can contribute to **atherogenesis**. AGEs appear to be involved in both **microvascular** and **macrovascular** damage in diabetes mellitus. Endothelial cells and macrophages have AGE receptors on their surfaces; uptake of glycated proteins by these receptors can activate the transcription factor **NF- κ B** (see [Chapter 52](#)), generating a variety of **cytokines** and **proinflammatory molecules**.

Nonenzymic glycation of **hemoglobin A** present in red blood cells leads to the formation of **HbA_{1c}**. It occurs normally to a small extent, and is increased in diabetic patients with poor glycemic control, whose blood glucose concentration is consistently elevated. As discussed in [Chapter 6](#), measurement of HbA_{1c} has become a very important part of the **management of patients with diabetes mellitus**.

GLYCOPROTEINS ARE INVOLVED IN MANY BIOLOGICAL PROCESSES & IN MANY DISEASES

As listed in [Table 46–1](#), glycoproteins have many different functions, including transport molecules, immunological molecules, and hormones. They are also important in fertilization and inflammation; a number of diseases are due to defects in the synthesis and catabolism of glycoproteins.

Glycoproteins Are Important in Fertilization

To reach the plasma membrane of an oocyte, a sperm has to traverse the **zona pellucida (ZP)**, a thick, transparent, envelope that surrounds the oocyte. The glycoprotein ZP3 is an *O*-linked glycoprotein that functions as a sperm receptor. A protein on the sperm surface interacts with the oligosaccharide chains of ZP3. By transmembrane signaling, this interaction induces the **acrosomal reaction**, in which enzymes such as proteases and hyaluronidase and other contents of the acrosome of the sperm are released. Liberation of these enzymes permits the sperm to pass through the zona pellucida and reach the plasma membrane of the oocyte. Another glycoprotein, PH-30, is important in binding of the sperm plasma

membrane to that of the oocyte, and the subsequent fusion of the two membranes, enabling the sperm to enter and fertilize the oocyte.

Selectins Play Key Roles in Inflammation & in Lymphocyte Homing

Leukocytes play important roles in many inflammatory and immunological processes; the first steps are interactions between circulating leukocytes and **endothelial cells** prior to passage of the leukocytes out of the circulation. Leukocytes and endothelial cells contain cell surface lectins, called **selectins**, which participate in intercellular adhesion. Selectins are single-chain Ca^{2+} -binding transmembrane proteins; the amino terminals contain the lectin domain, which is involved in binding to specific carbohydrate ligands.

Interactions between selectins on the neutrophil cell surface and glycoproteins on the endothelial cell trap the neutrophils temporarily, so that they roll over the endothelial surface. During this the neutrophils are activated, undergo a change in shape, and now adhere firmly to the endothelium. This adhesion is the result of interactions between **integrins** (see [Chapter 53](#)) on the neutrophils and immunoglobulin-related proteins on the endothelial cells. After adhesion, the neutrophils insert pseudopodia into the junctions between endothelial cells, squeeze through these junctions, cross the basement membrane, and are then free to migrate in the extravascular space.

Selectins bind **sialylated and fucosylated oligosaccharides**. Sulfated lipids (see [Chapter 21](#)) may also be ligands. Synthesis of compounds such as monoclonal antibodies that block selectin-ligand interactions may be therapeutically useful to inhibit inflammatory responses. **Cancer cells** often have selectin ligands on their surfaces, which may have a role in the invasion and metastasis of cancer cells.

Abnormalities in the Synthesis of Glycoproteins Underlie Certain Diseases

Leukocyte adhesion deficiency II is a rare condition due to mutations affecting the activity of a Golgi-located GDP-fucose transporter. The absence of fucosylated ligands for selectins leads to a marked decrease in neutrophil rolling. Patients suffer life-threatening recurrent bacterial infections, and also psychomotor and mental retardation. The condition may respond to oral fucose.

Paroxysmal nocturnal hemoglobinuria is an acquired mild anemia characterized by the presence of hemoglobin in urine due to hemolysis of red cells, particularly during sleep, reflecting a slight drop in plasma pH during sleep, which increases susceptibility to lysis by the complement system (see [Chapter 52](#)). The condition is due to the acquisition in hematopoietic cells of somatic mutations in the gene coding for the enzyme that links glucosamine to phosphatidylinositol in the GPI structure. This leads to a deficiency of proteins that are anchored to the red cell membrane by GPI linkage. Two proteins, **decay accelerating factor** and **CD59** normally interact with components of the complement system to prevent the hemolysis. When they are deficient, the complement system acts on the red cell membrane to cause hemolysis.

Some of the **congenital muscular dystrophies** are the result of defects in the synthesis of glycans in the protein α -dystroglycan. This protein protrudes from the surface membrane of muscle cells and interacts with laminin-2 (merosin) in the basal lamina. If the glycans of α -dystroglycan are not correctly formed (as a result of mutations in genes encoding some glycosyltransferases), this results in defective interaction of α -DG with laminin.

Rheumatoid arthritis is associated with an alteration in the glycosylation of circulating immunoglobulin G (IgG) molecules (see [Chapter 52](#)), such that they lack galactose in their Fc regions and terminate in *N*-acetylglucosamine. **Mannose-binding protein**, a lectin synthesized by liver cells and secreted into the circulation, binds mannose, *N*-acetylglucosamine, and some other sugars. It can thus bind agalactosyl IgG molecules, which subsequently activate the complement system, contributing to chronic inflammation in the synovial membranes of joints.

Mannose-binding protein can also bind sugars when they are present on the surfaces of bacteria, fungi, and viruses, preparing these pathogens for opsonization or for destruction by the complement system. This is an example of **innate immunity**, not involving immunoglobulins or T lymphocytes. Deficiency of this protein in young infants as a result of mutation renders them susceptible to recurrent infections.

Inclusion Cell (I-Cell) Disease Results From Faulty Targeting of Lysosomal Enzymes

Mannose 6-phosphate serves to target enzymes into the lysosome. I-cell disease is a rare condition characterized by severe progressive psychomotor retardation and a variety of physical signs, with death often

occurring in the first decade of life. Cells from patients with I-cell disease lack almost all of the normal lysosomal enzymes; the lysosomes thus accumulate many different types of undegraded molecules, forming inclusion bodies. The patients' plasma contains very high activities of lysosomal enzymes, suggesting that the enzymes are synthesized but fail to reach their proper intracellular destination and are instead secreted. Lysosomal enzymes from normal individuals carry the mannose 6-phosphate recognition marker, cells from patients with I-cell disease lack the Golgi-located *N*-acetylglucosamine phosphotransferase. Two lectins act as **mannose 6-phosphate receptor proteins**; both function in the intracellular sorting of lysosomal enzymes into clathrin-coated vesicles in the Golgi. These vesicles then leave the Golgi and fuse with a prelysosomal compartment.

Genetic Deficiencies of Glycoprotein Lysosomal Hydrolases Cause Diseases Such as α -Mannosidosis

Turnover of glycoproteins involves catabolism of the oligosaccharide chains catalyzed by a number of lysosomal hydrolases, including α -neuraminidase, β -galactosidase, β -hexosaminidase, α - and β -mannosidases, α -*N*-acetylgalactosaminidase, α -fucosidase, endo- β -*N*-acetylglucosaminidase, and aspartylglucosaminidase. Genetic defects of these enzymes result in abnormal degradation of glycoproteins. The accumulation in tissues of partially degraded glycoproteins leads to various diseases. Among the best recognized of these are mannosidosis, fucosidosis, sialidosis, aspartylglucosaminuria, and Schindler disease, due respectively to deficiencies of α -mannosidase, α -fucosidase, α -neuraminidase, aspartylglucosaminidase, and α -*N*-acetylgalactosaminidase.

GLYCANS ARE INVOLVED IN THE BINDING OF VIRUSES, BACTERIA, & SOME PARASITES TO HUMAN CELLS

A feature of glycans that explains many of their biological actions is that they bind specifically to proteins and other glycans. One reflection of this is their ability to bind some viruses, bacteria, and parasites.

Influenza virus A binds to cell surface glycoprotein receptor molecules containing *N*-acetylneuraminic acid via a **hemagglutinin** protein. The

virus also has a **neuraminidase** that plays a key role in allowing elution of newly synthesized progeny from infected cells. If this process is inhibited, spread of the viruses is markedly diminished. Inhibitors of this enzyme (eg, zanamivir, oseltamivir) are now available for use in treating patients with influenza. Influenza viruses are classified according to the type of hemagglutinin (H) and neuraminidase (N) that they possess. There are at least 16 types of hemagglutinin and 9 types of neuraminidase. Thus, **avian influenza virus** is classified as **H5N1**.

Human immunodeficiency virus type 1 (HIV-1), the cause of AIDS, attaches to cells via one of its surface glycoproteins (gp 120) and uses another surface glycoprotein (gp 41) to fuse with the host cell membrane. **Antibodies** to gp 120 develop during infection by HIV-1, and there has been interest in using the protein as a vaccine. One major problem with this approach is that the structure of gp 120 can change relatively rapidly due to mutations, allowing the virus to escape from the neutralizing activity of antibodies directed against it.

Helicobacter pylori is the major cause of **peptic ulcers**. It binds to at least two different glycans present on the surfaces of epithelial cells in the stomach allowing it to establish a stable attachment site to the stomach lining. Similarly, many bacteria that cause **diarrhea** attach to surface cells of the intestinal mucosa via glycans present in glycoproteins or glycolipids. The attachment of the malarial parasite *Plasmodium falciparum* to human cells is mediated by a GPI present on the surface of the parasite.

SUMMARY

- Glycoproteins are widely distributed proteins with diverse functions that contain one or more covalently linked carbohydrate chains.
- The carbohydrate content of a glycoprotein ranges from 1 to more than 85% of its weight and may be simple or very complex in the structure. Eight sugars are mainly found in the sugar chains of human glycoproteins: xylose, fucose, galactose, glucose, mannose, *N*-acetylgalactosamine, *N*-acetylglucosamine, and *N*-acetylneuraminic acid.
- Some of the oligosaccharide chains of glycoproteins encode biological information; they are also important in modulating the solubility and viscosity of glycoproteins, in protecting them against proteolysis, and in their biologic actions.
- Glycosidases hydrolyze specific linkages in oligosaccharides.

- Lectins are carbohydrate-binding proteins involved in cell adhesion and many other processes.
- The major classes of glycoproteins are *O*-linked (involving serine or threonine), *N*-linked (involving the amide group of asparagine), and GPI-linked.
- Mucins are a class of *O*-linked glycoproteins that are distributed on the surfaces of epithelial cells of the respiratory, gastrointestinal, and reproductive tracts.
- The endoplasmic reticulum and Golgi apparatus play a major role in glycosylation reactions involved in the biosynthesis of glycoproteins.
- The oligosaccharide chains of *O*-linked glycoproteins are synthesized by the stepwise addition of sugars donated by sugar nucleotides in reactions catalyzed by glycoprotein glycosyltransferases.
- The synthesis of *N*-linked glycoproteins involves a dolichol-P-P-oligosaccharide and various glycotransferases and glycosidases. Depending on the enzymes and precursor proteins in a tissue, it can synthesize complex, hybrid, or high-mannose types of *N*-linked oligosaccharides.
- Glycoproteins are implicated in many biological processes, including fertilization and inflammation.
- There are a number of diseases involving abnormalities in the synthesis and degradation of glycoproteins. Glycoproteins are also involved in many other diseases, including influenza, AIDS, rheumatoid arthritis, cystic fibrosis, and peptic ulcer.

Metabolism of Xenobiotics

David A. Bender, PhD & Robert K. Murray, MD, PhD

OBJECTIVES

After studying this chapter, you should be able to:

- Describe the two phases of xenobiotic metabolism, the first involving mainly hydroxylation reactions catalyzed by cytochromes P450 and the second conjugation reactions.
- Describe the metabolic importance of glutathione.
- Describe how xenobiotics can have toxic, immunological, and carcinogenic effects.

BIOMEDICAL IMPORTANCE

We are exposed to a wide variety of compounds that are foreign to the body (**xenobiotics**, from the Greek *xenos* = foreign); naturally occurring compounds in plant foods, and synthetic compounds in medicines, food additives, and environmental pollutants. Knowledge of the metabolism of xenobiotics is essential for an understanding of pharmacology, therapeutics, and toxicology. Many of the xenobiotics in plant foods have potentially beneficial effects (eg, acting as antioxidants, [Chapter 45](#)).

Understanding the mechanisms involved in xenobiotic metabolism will permit the development of transgenic microorganisms and plants containing genes that encode enzymes that can be used to render potentially hazardous pollutants harmless. Similarly, transgenic organisms may be used for biosynthesis of drugs and other chemicals.

WE ENCOUNTER MANY XENOBIOTICS THAT MUST BE METABOLIZED BEFORE BEING EXCRETED

The main xenobiotics of medical relevance are **drugs, chemical carcinogens**, naturally occurring compounds in plant foods, and a wide variety of compounds that have found their way into our environment, such as polychlorinated biphenyls (PCBs), and insecticides and other pesticides. Most of these compounds are metabolized, mainly in the liver. While the metabolism of xenobiotics is generally considered to be a process of detoxification, sometimes the metabolites of compounds that are themselves inert or harmless are biologically active. This may be desirable, as in the activation of a prodrug to the active compound, or it may be undesirable, as in the formation of a carcinogen or mutagen from an inert precursor.

The metabolism of xenobiotics occurs in two phases. In **phase 1**, the major reaction involved is **hydroxylation**, catalyzed by enzymes that are **monooxygenases** or **cytochromes P450**. In addition to hydroxylation, these enzymes catalyze a wide range of other reactions, including deamination, dehalogenation, desulfuration, epoxidation, peroxygenation, and reduction. Reactions involving hydrolysis (eg, catalyzed by esterases) and other non-P450-catalyzed reactions also occur in phase 1.

Phase 1 metabolism renders compounds more reactive, introducing groups that can be conjugated with glucuronic acid, sulfate, acetate, glutathione, or amino acids in phase 2 metabolism. This produces **polar compounds** that are water-soluble and can therefore be excreted in urine or bile.

In some cases, phase 1 metabolic reactions convert xenobiotics from **inactive** to **biologically active** compounds. In these instances, the original xenobiotics are referred to as **prodrugs** or **procarcinogens**. Sometimes, additional phase 1 reactions (eg, further hydroxylation reactions) convert these active compounds into less active or inactive forms prior to conjugation. In other cases, it is the conjugation reactions that convert the

active products of phase 1 reactions to inactive compounds, which are excreted.

ISOFORMS OF CYTOCHROME P450 HYDROXYLATE A WIDE VARIETY OF XENOBIOTICS IN PHASE 1 METABOLISM

The main reaction involved in phase 1 metabolism is **hydroxylation**, catalyzed by a family of enzymes known as **monooxygenases** or **cytochromes P450**. There are at least 57 cytochrome P450 genes in the human genome. Cytochrome P450 is a heme enzyme. It is so named because it was originally discovered when it was noted that preparations of microsomes (fragments of the endoplasmic reticulum) that had been chemically reduced and then exposed to carbon monoxide had an absorption peak at 450 nm.

At least half of the common drugs that we ingest are metabolized by isoforms of cytochrome P450. They also act on steroid hormones, carcinogens, and pollutants. In addition, cytochromes P450 are important in the metabolism of a number of physiological compounds—for example, the synthesis of steroid hormones (see [Chapter 26](#)) and the conversion of vitamin D to its active metabolite, calcitriol (see [Chapter 44](#)).

The overall reaction catalyzed by cytochrome P450 is:

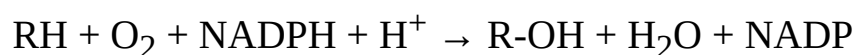

The reaction mechanism is shown in [Figure 12–6](#). **NADPH-cytochrome P450 reductase** catalyzes the transfer of electrons from NADPH to cytochrome P450. Reduced cytochrome P450 catalyzes the **reductive activation of molecular oxygen**, one atom of which becomes the hydroxyl group in the substrate and the other is reduced to water. **Cytochrome b5**, another hemoprotein found in the membranes of the smooth endoplasmic reticulum (see [Chapter 12](#)), may be involved as an electron donor in some cases.

Isoforms of Cytochrome P450 Form a Superfamily of Heme-Containing Enzymes

There is a **systematic nomenclature** for the cytochromes P450 and their genes, based on their amino acid sequence homology. The root CYP

denotes a cytochrome P450. This is followed by number designating the **family**; cytochromes P450 are included in the same family if they exhibit 40% or more amino acid sequence identity. This is followed by a capital letter indicating the **subfamily**; P450s are in the same subfamily if they exhibit more than 55% sequence identity. The **individual** P450s are then assigned numbers in their subfamily. Thus, CYP1A1 denotes a cytochrome P450 that is a member of family 1 and subfamily A and is the first individual member of that subfamily. The nomenclature for the **genes** encoding cytochromes P450 is the same, except that italics are used; thus, the gene encoding CYP1A1 is *CYP1A1*.

The major cytochromes P450 involved in drug metabolism are CYP1 (with 3 subfamilies), CYP2 (13 subfamilies), and CYP3 (1 subfamily). The various cytochromes P450 have overlapping substrate specificities, so that a very broad range of xenobiotics can be metabolized by one or other of the enzymes.

Cytochromes P450 are present in greatest amount in **liver cells** and enterocytes. In liver and most other tissues, they are present mainly in the **membranes of the smooth endoplasmic reticulum**, which constitute part of the **microsomal fraction** when tissue is subjected to subcellular fractionation. In hepatic microsomes, cytochromes P450 can comprise as much as 20% of the total protein. In the **adrenal gland**, where they are involved in cholesterol and steroid hormone biosynthesis, they are found in **mitochondria** as well as in the endoplasmic reticulum (see [Chapters 26](#) and [41](#)).

Overlapping Specificity of Cytochromes P450 Explains Interactions Between Drugs and Between Drugs and Nutrients

Most isoforms of cytochrome P450 are **inducible**. For instance, the administration of phenobarbital or other drugs causes hypertrophy of the smooth endoplasmic reticulum and a three- to fourfold increase in the amount of cytochrome P450 within a few days. In most cases this involves increased transcription to mRNA. However, in some cases, induction involves stabilization of mRNA or the enzyme protein itself, or increased translation of existing mRNA.

Induction of cytochrome P450 underlies **drug interactions**, when the effects of one drug are altered by administration of another. For example, the anticoagulant **warfarin** is metabolized by **CYP2C9**, which is induced

by phenobarbital. Induction of CYP2C9 will increase the metabolism of warfarin, so reducing its efficacy, so that the dose must be increased. CYP2E1 catabolizes the metabolism of some widely used solvents and compounds found in tobacco smoke, many of which are **procarcinogens**; it is induced by **ethanol**, so increasing the risk of carcinogenicity.

Naturally occurring compounds in foods may also affect cytochrome P450. Grapefruit contains a variety of furanocoumarins, which inhibit cytochrome P450 and so affect the metabolism of many drugs. Some drugs are activated by cytochrome P450, so that grapefruit will reduce their activity; others are inactivated by cytochrome P450, so that grapefruit increases their activity. Drugs that are affected include statins, omeprazole, antihistamines, and benzodiazepine antidepressants.

Polymorphism of cytochromes P450 may explain much of the variation in drug responses by different patients; variants with low catalytic activity will lead to slower metabolism of the substrate, and hence prolonged drug action. **CYP2A6** is involved in the metabolism of **nicotine** to conitine. Three *CYP2A6* alleles have been identified: a wild type and two inactive alleles. Individuals with the null alleles, who have impaired metabolism of nicotine, are apparently protected against becoming tobacco-dependent smokers. These individuals smoke less, presumably because their blood and brain concentrations of nicotine remain elevated longer than those of individuals with the wild-type allele. It has been speculated that inhibiting CYP2A6 may provide a novel way to help smoking cessation.

CONJUGATION REACTIONS IN PHASE 2 METABOLISM PREPARE XENOBIOTICS FOR EXCRETION

In phase 1 reactions, xenobiotics are converted to more polar, hydroxylated derivatives. In phase 2 reactions, these derivatives are conjugated with molecules such as glucuronic acid, sulfate, or glutathione. This renders them even more water-soluble, and they are eventually excreted in the urine or bile.

Glucuronidation Is the Most Frequent Conjugation Reaction

The **glucuronidation** of bilirubin is discussed in [Chapter 31](#); xenobiotics

are glucuronidated in the same way, using UDP-glucuronic acid (see [Figure 20–4](#)), catalyzed by a variety of glucuronosyltransferases, present in both the endoplasmic reticulum and cytosol. Molecules such as 2-acetylaminofluorene (a carcinogen), aniline, benzoic acid, meprobamate (a tranquilizer), phenol, and many steroid hormones are excreted as glucuronides. The glucuronide may be attached to oxygen, nitrogen, or sulfur groups of the substrates.

Some Alcohols, Arylamines, and Phenols Are Sulfated

The **sulfate donor** in these and other biologic and sulfation reactions (eg, sulfation of steroids, glycosaminoglycans, glycolipids, and glycoproteins) is “active sulfate”—**adenosine 3'-phosphate-5'-phosphosulfate (PAPS**, see [Chapter 24](#)).

Glutathione Is Required for Conjugation of Electrophilic Compounds

The tripeptide glutathione (γ -glutamylcysteinylglycine) is important in the phase II metabolism of electrophilic compounds, forming glutathione S-conjugates that are excreted in urine and bile. The reaction catalyzed by glutathione S-transferases is:

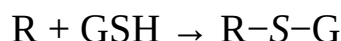

where R is an electrophilic compound.

There are four classes of cytosolic glutathione S-transferase and two classes of microsomal membrane-bound enzyme, as well as a structurally distinct kappa class that is found in mitochondria and peroxisomes. Glutathione S-transferases are homo- or heterodimers of at least seven different types of subunit, and different subunits are induced by different xenobiotics.

Because glutathione S-transferases also bind a number of ligands that are not substrates, including bilirubin, steroid hormones, and some carcinogens and their metabolites, they are sometimes known as **ligandin**. Glutathione S-transferase binds bilirubin at a site distinct from the catalytic site, transporting it from the bloodstream to the liver, then to the endoplasmic reticulum for conjugation with glucuronic acid, and excretion in the bile (see [Chapter 31](#)). Binding of carcinogens sequesters them, so preventing their actions on DNA.

The liver has a very high activity of glutathione *S*-transferase; in vitro the entire pool of glutathione can be depleted within minutes on exposure to a xenobiotic substrate. The activity of glutathione *S*-transferase is upregulated in many tumors, leading to resistance to chemotherapy.

Glutathione conjugates may be transported out of the liver, where they are substrates for extracellular γ -glutamyltranspeptidase and dipeptidases. The resultant cysteine *S*-conjugates are taken up by other tissues (especially the kidney) and *N*-acetylated to yield mercapturic acids (*N*-acetylcysteine *S*-conjugates), which are excreted in the urine. Some hepatic glutathione *S*-conjugates enter the bile canaliculi, where they are broken down to cysteine *S*-conjugates that are then taken up into the liver for *N*-acetylation, and re-excreted in the bile.

In addition to its role in phase 2 metabolism, glutathione has a number of other roles in metabolism:

1. It provides the reductant for the reduction of **hydrogen peroxide** to water in the reaction catalyzed by glutathione peroxidase (see [Figure 20–3](#)).
2. It is an important **intracellular reductant and antioxidant**, helping to maintain essential SH groups of enzymes in their reduced state.
2. A metabolic cycle involving GSH as a carrier has been implicated in the **transport of some amino acids** across membranes in the kidney. The first reaction of the cycle is catalyzed by **γ -glutamyltransferase (GGT)**:

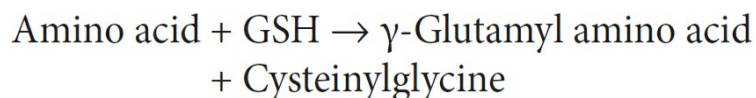

This reaction transfers amino acids across the plasma membrane, the amino acid being subsequently hydrolyzed from its complex with glutamate and the GSH being resynthesized from cysteinylglycine. GGT is present in the plasma membrane of renal tubular cells and bile ductule cells, and in the endoplasmic reticulum of hepatocytes. It is released into the blood from hepatic cells in various hepatobiliary diseases, providing an early indication of liver damage.

OTHER REACTIONS ARE ALSO INVOLVED IN PHASE 2 METABOLISM

The two most important reactions other than conjugation are acetylation

and methylation.

The reaction of **acetylation** is:

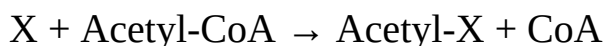

where X represents a xenobiotic or its metabolite. As for other acetylation reactions, **acetyl-CoA** is the acetyl donor. These reactions are catalyzed by **acetyltransferases** present in the cytosol of various tissues, particularly liver. The drug **isoniazid**, used in the treatment of tuberculosis, is subject to acetylation. There is polymorphism of acetyltransferases, resulting in individuals who are classified as **slow or fast acetylators**. Slow acetylators are more subject to the toxic effects of isoniazid because the drug persists for longer.

Some xenobiotics are subject to **methylation** by methyltransferases, employing S-adenosylmethionine (see [Figure 29–17](#)) as the methyl donor.

RESPONSES TO XENOBIOTICS INCLUDE TOXIC, IMMUNOLOGICAL, & CARCINOGENIC EFFECTS

There are very few xenobiotics, including drugs, that do not have some toxic effects if the dose is large enough. The **toxic effects of xenobiotics** cover a wide spectrum, but can be considered under three general headings:

1. Covalent binding of xenobiotic metabolites to macromolecules including **DNA, RNA, and protein** can lead to cell injury (**cytotoxicity**), which can be severe enough to result in cell death. In response to damage to DNA, the **DNA repair mechanism** of the cell is activated. Part of this involves the transfer of multiple ADP-ribose units onto DNA-binding proteins, catalyzed by poly(ADP-ribose polymerase). The source of ADP-ribose is NAD, and in response to severe DNA damage there is considerable depletion of NAD. In turn, this leads to severely impaired ATP formation, and cell death.
2. The reactive metabolite of a xenobiotic may bind to a protein, acting as a hapten, and altering its **antigenicity**. On its own it will not stimulate antibody production, but does so when bound to a protein. The resultant antibodies react not only with the modified protein but also with the unmodified protein, so potentially initiating **autoimmune disease**.

2. Reactions of some activated xenobiotics with **DNA** are important in **chemical carcinogenesis**. Some chemicals (eg, benzo[α]pyrene) require activation by cytochrome P450 in the endoplasmic reticulum to become carcinogenic (they are therefore called **indirect carcinogens**). The activities of the xenobiotic-metabolizing enzymes present in the endoplasmic reticulum thus help to determine whether such compounds become carcinogenic or are “detoxified.”

The enzyme **epoxide hydrolase** in the membranes of the endoplasmic reticulum can have protection against some carcinogens. The products of the action of cytochrome P450 on some procarcinogen substrates are **epoxides**. Epoxides are highly reactive and mutagenic or carcinogenic. As shown in **Figure 47–1**, the hydrolase catalyzes hydrolysis of epoxides to much less reactive dihydrodiols.

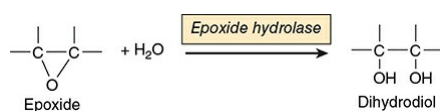

FIGURE 47–1 The reaction of epoxide hydrolase.

SUMMARY

- Xenobiotics are chemical compounds foreign to the body, including drugs, food additives, and environmental pollutants, as well as naturally occurring compounds in plant foods.
- Xenobiotics are metabolized in two phases. The major reaction of phase 1 is hydroxylation catalyzed by a variety of monooxygenases, known as the cytochromes P450. In phase 2, the hydroxylated species are conjugated with a variety of hydrophilic compounds such as glucuronic acid, sulfate, or glutathione. The combined operation of these two phases converts lipophilic compounds into water-soluble compounds that can be excreted in urine or bile.
- Cytochromes P450 catalyze reactions that introduce one atom of oxygen derived from molecular oxygen into the substrate, yielding a hydroxylated product, and the other into water. NADPH and NADPH cytochrome P450 reductase are involved in the reaction mechanism.
- Cytochromes P450 are hemoproteins and generally have a wide substrate specificity, acting on many exogenous and endogenous substrates. At least 57 cytochrome P450 genes are found in human tissue.
- Cytochromes P450 are generally located in the endoplasmic reticulum

of cells, especially in the liver.

- Many cytochromes P450 are inducible. This has important implications for interactions between drugs.
- Phase 2 conjugation reactions are catalyzed by enzymes such as glucuronyltransferases, sulfotransferases, and glutathione *S*-transferases, using UDP-glucuronic acid, PAPS (active sulfate), and glutathione, respectively, as donors.
- Glutathione not only plays an important role in phase 2 reactions but also is an intracellular reducing agent.
- Xenobiotics can produce a variety of biological effects, including toxicity, immunological reactions, and cancer.

Clinical Biochemistry

David A. Bender, PhD & Robert K. Murray, MD, PhD

OBJECTIVES

After studying this chapter, you should be able to:

- Explain the importance of laboratory tests in clinical and veterinary medicine.
- Explain what is meant by the reference range for the results of a test.
- Explain the difference between the precision and accuracy of an assay method, and explain the sensitivity and specificity of an assay method.
- Explain what is meant by the sensitivity, specificity, and predictive value of a laboratory test.
- List techniques that are commonly used in a diagnostic lab carrying out biochemical tests and explain the principle of each method.
- Explain why high plasma concentrations of enzymes are considered to be indicators of tissue damage.
- Describe in outline the different requirements for measuring an enzyme in a plasma sample and using an enzyme to measure an analyte.

THE IMPORTANCE OF LABORATORY TESTS IN MEDICINE

Various laboratory tests are an essential part of medicine and veterinary practice. Biochemical tests can be used for screening for disease, for confirmation (or otherwise) of a diagnosis made on clinical examination, for monitoring progression of a disease and the outcome of treatment. Blood and urine samples are most commonly used; occasionally feces, saliva, or cerebrospinal fluid (CSF) may be used, and on rare occasions, tissue biopsy samples. Most of our knowledge and understanding of the underlying causes of metabolic diseases and of the effects of disease on metabolism has come from analysis of metabolites in blood and urine, and from measurement of enzymes in blood. In turn, that knowledge has permitted advances in the treatment of disease and the development of more effective drugs.

Advances in technology mean that many tests that were formerly carried out only in specialist laboratories can now be performed at the bedside, in the doctor's office, or veterinary practice, sometimes even at home by patients themselves, with automated machines or "dipsticks" that are simple to use. Other tests are still conducted in hospital laboratories or by private clinical chemistry laboratories, with samples sent in by the referring physician. Some tests that are less commonly requested and may be technically more demanding are performed only in specialist centers. These often involve specialist techniques to study rare (and sometimes newly discovered) metabolic diseases. In addition, testing of samples from athletes and race horses for performance-enhancing drugs and other banned substances is normally carried out in only a limited number of specially licensed laboratories.

CAUSES OF ABNORMALITIES IN LEVELS OF ANALYTES MEASURED IN THE LABORATORY

A great many different conditions can lead to abnormalities of the results of laboratory tests. Tissue injury that results in damage to cell membranes and an increase in the permeability of the plasma membrane leads to leakage of intracellular material into the bloodstream (eg, leakage of creatine kinase MB into the bloodstream following a myocardial infarction). In other cases, the synthesis of proteins and hormones is

increased or decreased (eg, C-reactive protein in inflammatory states, or hormones in endocrine disorders). Kidney and liver failure lead to the accumulation of a number of compounds (eg, creatinine and bilirubin, respectively) in the blood, due to an inability of the organ concerned to excrete or metabolize the compound concerned.

THE REFERENCE RANGE

For any compound that is measured (an **analyte**), there is a range of values around the average or mean that can be considered to be normal. This is the result of biological variations between individuals. In addition, day-to-day or week-to-week variations can occur in the results for the same individual. Therefore, the first step in establishing any new laboratory test for screening for, or diagnosis of, disease, or monitoring treatment, is to determine the range of results in a population of healthy people. For some tests, this will also mean determining the normal ranges of analytes in people of different ages. The normal range of some analytes will differ between men and women, and there may be differences between different ethnic groups to be considered as well.

If the results obtained for a target healthy population group (depending on age, gender, and perhaps ethnicity) are statistically normally distributed (ie, the results show a symmetrical gaussian distribution around the mean), then the acceptable or normal range is taken to be $\pm 2x$ standard deviation around the mean. This range includes 95% of the target population, and is known as the reference range. Values outside the reference range are considered to be abnormal, meriting further investigation. If the results from the healthy population are not statistically normally distributed, but skewed, then a further step of statistical manipulation is required before the 95% reference range can be established.

For some tests, the results from different laboratories will differ, usually because they use different methods of measurement. Each laboratory establishes its own set of reference ranges for the analyses it performs. Some laboratories report the results as the value; others report results as the number of standard deviations away from the mean—the so-called Z-score. This allows the physician to see how far from the mean the result is—in other words, how abnormal it is. Sometimes the results will be reported as 5 or 10 (or more) times above the upper limit of normal.

The use of the 95% range as the reference range has an unfortunate consequence. By chance, 5% of the “normal” results will be outside the reference range. This first became apparent in the 1970s, when

multichannel analysers were developed that were capable of determining 20 or more analytes in each sample. Almost every sample gave one result that was outside the reference range, but if the same person gave a sample a few days later, that apparently abnormal result was now within the reference range, although by chance the result for another analyte might now be outside the reference range.

VALIDITY OF LABORATORY RESULTS

Diagnostic laboratories are subject to inspection and regulatory procedures to assess the validity of their results and ensure **quality control** of their reports. Such measures will ensure that the value of the concentration, activity, or amount of a substance in a specimen reported represents the best value obtainable with the method, reagents, and instruments used.

In establishing a new test, or a new method, four questions have to be answered:

- 1. How precise is the method?** This is a measure of the reproducibility of the method. If the same sample is analyzed many times over, how much variation will be seen in the results obtained? **Figure 48–1** illustrates this. In this example, one set of results is much more precise than the other (there is a difference between the two in the spread of results around the mean), even though they have the same mean result. Precision is not absolute, but subject to variations inherent in the complexity of the method used, the stability of reagents, the sophistication of the equipment used for the assay, and the skill of the technicians involved.

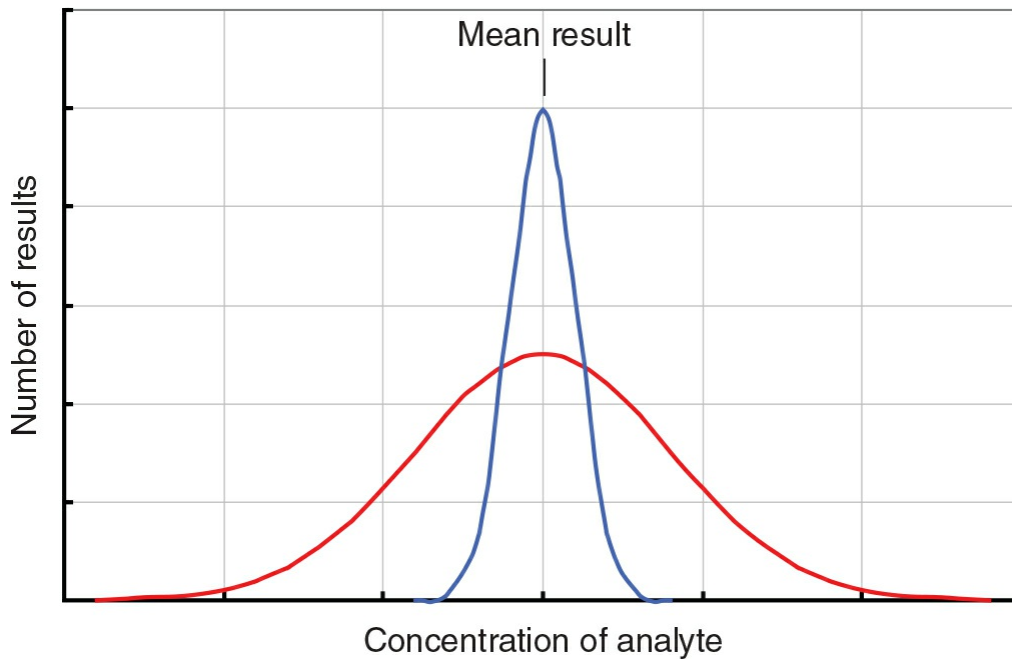

FIGURE 48–1 Precision of an analytical method. The graph shows the results of an analyte measured multiple times in the same sample, either by two different analytical methods or by the same method in two different laboratories. In both cases, the mean result is the same. However, one method or laboratory, shown in blue, has a low scatter of results, and hence a low standard deviation, and high precision, while the other, shown in red, has a high scatter of results, a high standard deviation, and low precision.

- 2. How accurate is the result?** This is a measure of how close the result is to the true value. **Figure 48–2** shows the results of assays by two different methods or by the same method but in two different laboratories. Both have similar precision, but their mean values are very different. It is not possible to say from this information which laboratory is correct (and this is part of the reason why laboratories establish their own reference ranges). There are a number of national or regional quality control schemes in which all participating laboratories are sent the same (pooled) blood or urine sample. Each laboratory measures the various analytes in the pooled sample. The results obtained by all laboratories are plotted as a distribution curve. The mean of these values is calculated and considered to be the “true value.” Such a quality control scheme allows each participating laboratory to determine how close its results are to the “true value.”

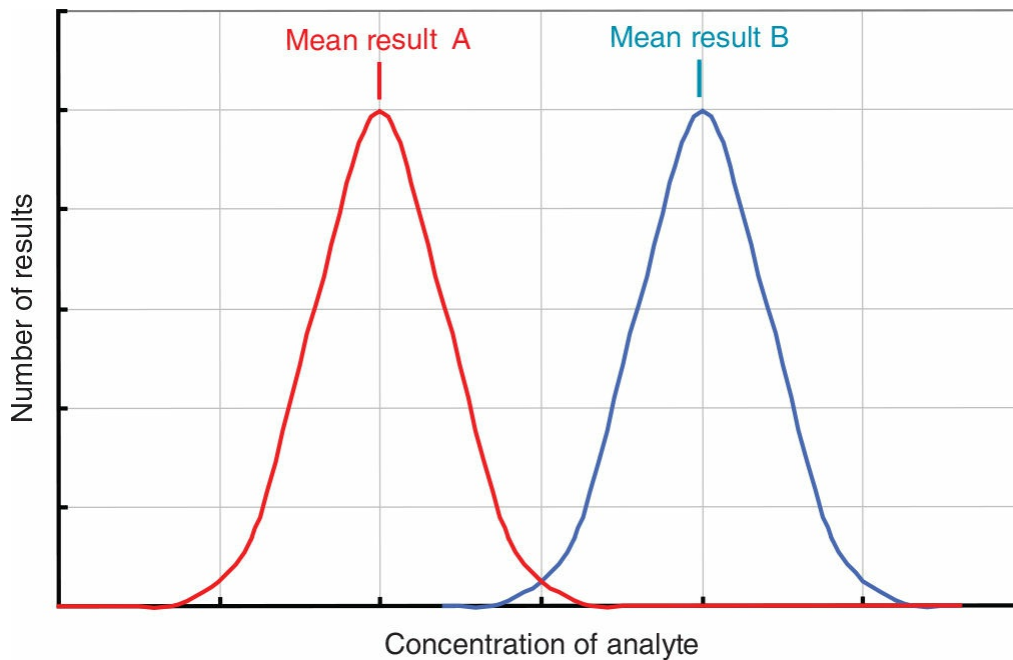

FIGURE 48–2 Accuracy of an analytical method. Two different analytical methods, performed on multiple samples, or the same method performed in two different laboratories, with the same scatter of results, and hence the same standard deviation and the same precision. However, the mean values of analytes obtained for the two methods or laboratories are very different; it is not possible to tell which result is closer to the true value.

3. **How sensitive is the method?** In other words, how little of the analyte can be determined reliably? What is the lower limit of reliable detection? This is obviously important when results below the reference range are clinically significant, or when samples are being analyzed for narcotics or performance-enhancing substances that are banned in competitive sport.
4. **How specific is the method?** This question deals with the issue of confidence that the assay is actually measuring the analyte of interest. For example, the now obsolete method of measuring glucose in blood or urine used an alkaline copper (Cu^{2+}) solution, which was reduced to Cu^+ by glucose. However, other reducing compounds in urine or blood, such as xylose or vitamin C, also reduce glucose giving a falsely high value. Modern methods of measuring glucose depend on the enzyme glucose oxidase, which only reacts with glucose, and so is highly specific. One of the products of the action of glucose oxidase on glucose is hydrogen peroxide; the second step in the assay is to reduce

the hydrogen peroxide produced to water and oxygen, using peroxidase. A colorless compound that turns blue when it is oxidized by the oxygen produced is also present in the assay medium. High concentrations of vitamin C, as would be seen when the patient is taking vitamin supplements, reduce the dye back to its colorless form, so giving a false-negative result (**Figure 48-3**).

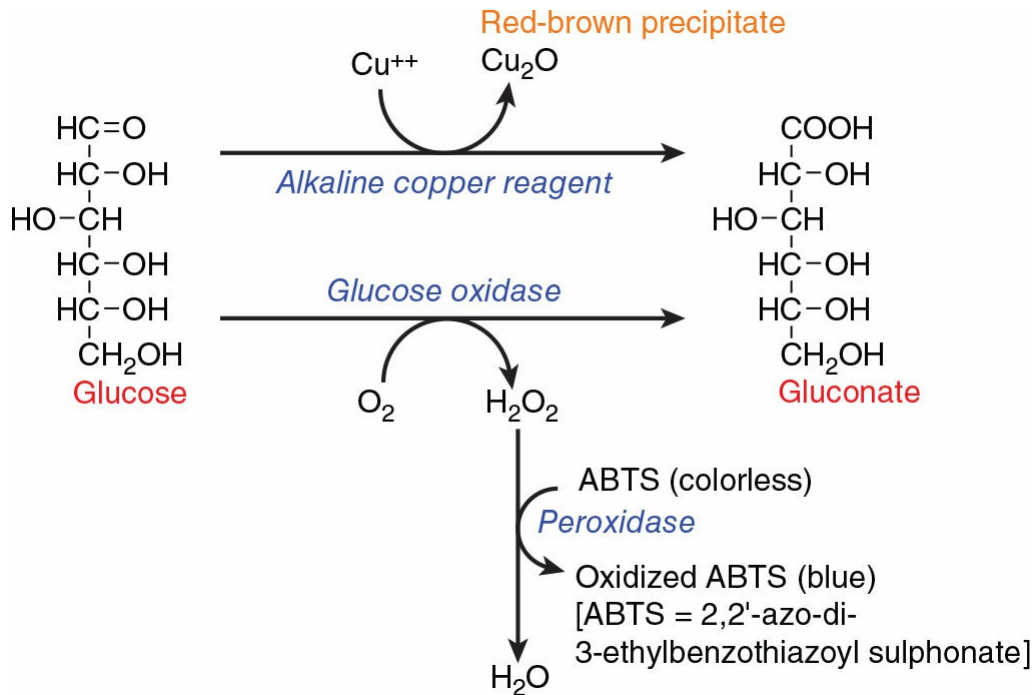

FIGURE 48-3 Specificity of an analytical method. Measurement of blood glucose by two methods. Chemical reduction of Cu^{2+} in alkaline solution will detect not only glucose, but any other reducing sugar and other substances such as vitamin C. Enzymic oxidation of glucose using glucose oxidase is a specific reaction; no other compound will be oxidized and contribute to the value obtained.

ASSESSMENT OF CLINICAL VALIDITY OF A LABORATORY TEST

The above four criteria must be established for each analytical method. In addition, the **clinical value** of the test has to be established by taking into consideration its sensitivity, specificity, and positive and negative predictive values (**Table 48-1**). Here, unfortunately, the same two terms, sensitivity and specificity, are used, but with very different meanings from those used in establishing the analytical method.

TABLE 48–1 Sensitivity, Specificity, and Positive and Negative Predictive Values of a Laboratory Test

		Does the Patient Have the Disease?	
		Yes	No
What is the result of the test?	Positive	True positive (a)	False positive (b)
	Negative	False negative (c)	True negative (d)
Sensitivity	=	$\frac{\text{True positive (a)} \times 100}{\text{Number of patients who have the disease (a + c)}}$	
Specificity	=	$\frac{\text{True negative (d)} \times 100}{\text{Number of patients who do not have the disease (b + d)}}$	
Positive predictive value	=	$\frac{\text{True positive (a)} \times 100}{\text{Number of patients who have a positive test (a + b)}}$	
Negative predictive value	=	$\frac{\text{True negative (d)} \times 100}{\text{Number of patients who have a negative test (c + d)}}$	

The **sensitivity** of a test is the **percentage of positive test results in patients with the disease (“true positive”)**. For example, the test for phenylketonuria is highly sensitive; a positive result is obtained in all who have the disease (100% sensitivity). By contrast, the carcinoembryonic antigen (CEA) test for carcinoma of the colon has lower sensitivity; only 72% of those with carcinoma of the colon test positive when the disease is extensive, and only 20% with early disease.

The **specificity** of a test is the **percentage of negative test results among people who do not have the disease**. The test for phenylketonuria is highly specific; 99.9% of normal individuals give a negative result; only 0.1% gives a false-positive result. By contrast, the CEA test has a variable specificity; about 3% of nonsmoking individuals give a false-positive result (97% specificity), whereas 20% of smokers give a false-positive result (80% specificity).

The sensitivity and specificity of a test are inversely related to each other. If the cutoff point is set too high, then very few healthy people will give a false-positive result, but many people with the disease may give a false-negative result. The sensitivity will thus be low, but the specificity will be high. Conversely, if the cutoff point is too low, then almost all people with the disease will be detected (the test will have a high

sensitivity), but more disease-free people may give a false-positive result (the test will have a low specificity).

The **predictive value of a positive test** (positive predictive value) is the percentage of positive results that are true positives. Similarly, the **predictive value of a negative test** (negative predictive value) is the percentage of negative results that are true negatives. This is related to the prevalence of the disease. For example, in a group of patients in a urology ward, the prevalence of renal disease is higher than in the general population. In this group, the serum concentration of creatinine will have a higher predictive value than in the general population. Formulae for calculating sensitivity, specificity, and predictive values of a diagnostic test are shown in [Table 48–1](#).

SAMPLES FOR ANALYSIS

The usual samples for analysis are blood and urine. Blood is collected into tubes with or without an anticoagulant, depending on whether plasma or serum is required. Less commonly, samples of saliva, CSF, or feces may be used.

There is a difference between measurement of an analyte in a blood sample and in urine. The concentration of an analyte in blood reflects levels at the time the sample was taken, whereas a urine sample represents the cumulative excretion of the analyte over a period of time. A further difference is that it is usual to report results of blood tests as amount of analyte (or enzyme activity) per milliliter or liter of blood (or plasma or serum). Reporting the concentration of the analyte in urine in the same way is not useful, since urine volume depends very largely on fluid intake. In some cases, the patient is asked to provide a complete 24-hour urine sample; this is a tedious procedure, and it is difficult to know whether there really has been a complete 24-hour collection. Alternatively, the concentration of the analyte is reported per mol of creatinine. Creatinine excretion is reasonably constant from day to day for any one individual, but varies between individuals because it depends mainly on muscle mass; creatinine is formed nonenzymically from creatine and creatine phosphate, most of which is in skeletal muscle.

Apart from measurement of blood gases, for which arterial samples are required, blood samples are usually of venous blood. Blood glucose is often measured in capillary blood from a finger prick. Some analyses use whole blood; others require either serum or plasma. For a serum sample, the blood is allowed to clot, then the red cells and fibrin clot are removed

by centrifugation. For a plasma sample, the blood is collected into a tube containing an anticoagulant, and the red cells are removed by centrifugation. The difference between serum and plasma is that plasma contains prothrombin and the other clotting factors, including fibrinogen, while serum does not. Different anticoagulants (citrate, EDTA or oxalate, all of which chelate calcium and so inhibit coagulation) are used for collection of plasma samples, depending on the assay to be performed. Heparin, which acts by activating antithrombin III, is also used. For measurement of blood glucose, potassium fluoride is added, as an inhibitor of glycolysis by red blood cells.

TECHNIQUES USED IN CLINICAL CHEMISTRY

Most routine clinical chemistry reactions involve linking a chemical or enzymic reaction to the development of a colored product that is measured by **absorption spectrophotometry**. Different compounds absorb light at different wavelengths; the energy of the absorbed light excites electrons to an unstable orbital. The absorbance of light at a specific wavelength in the visible or ultraviolet range is directly proportional to the concentration of the colored end-product, and hence to the concentration of the analyte in the sample. Although at one time such analyses were performed manually, nowadays most assays are automated, and a single instrument can carry out multiple assays on a single sample.

In absorption spectrophotometry, the excited electrons return to their basal state in a series of small quantum jumps, emitting the energy absorbed as heat. For some compounds the electrons return to a lower energy state in a single quantum jump, emitting light of a higher wavelength (lower energy) than the exciting light. This is fluorescence, and the technique is known as **fluorescence spectrophotometry** or **spectrophotofluorimetry**. The sample is illuminated with light of a specific wavelength, and the light emitted is measured, at right angles to the direction of the illuminating wavelength. Again, the intensity of the fluorescence is proportional to the concentration of the fluorophore, and hence the concentration of the analyte. Fluorimetry permits both greater specificity and sensitivity of the assay. The specificity is greater than for absorption spectrophotometry because both the exciting wavelength and the emitted wavelength are specific for the fluorophore, while for absorption spectrophotometry there is only one wavelength to be set, that of the light that is absorbed. Fluorimetry is more sensitive because it is easier to detect the emission of a small amount of light than the absorption.

Increasingly, especially in research and specialist centers, multiple analytes are measured in the same sample using **high-pressure liquid chromatography** to separate analytes, followed by colorimetric, fluorimetric, or electrochemical detection, or linked to mass spectrometry to identify compounds. Such methods form the basis of **metabolomics**, the study of a whole array of metabolites in a single sample, and **metabonomics**, the study of changes in analytes in response to a drug or experimental treatment of some kind.

Historically, **electrolytes** such as sodium and potassium were measured by **flame photometry**, measuring the light emitted when the ion was introduced into a clear flame. Sodium gives a yellow flame and potassium a purple one. Nowadays these and other ions are measured using **ion-specific electrodes**. In some cases, metal ions are measured by **atomic absorption spectrometry**. Here the sample is introduced into a flame, and illuminated at a specific wavelength. The light energy absorbed excites electrons to an unstable orbital, and the absorption of light is directly proportional to the concentration of the element in the sample, as is the case for absorption spectrophotometry.

Enzymes in Clinical Chemistry

Enzymes are important in clinical chemistry in three different ways: to measure analytes in a sample; to measure the activity of enzymes themselves in a sample; and as a test of vitamin nutritional status.

Using an enzyme to measure the concentration of an analyte confers a high degree of specificity on the assay, since in general an enzyme will act on only a single substrate, or a small range of closely related substrates, while a simple chemical reaction may well respond to a variety of (possibly unrelated) analytes. For example, as shown in [Figure 48–3](#), a variety of reducing compounds will react with an alkaline copper reagent to give a false-positive result for glucose, whereas the enzymic assay using glucose oxidase will only give a positive result for glucose, and not other reducing compounds.

When an enzyme is used to detect an analyte, the limiting factor in the assay must be the analyte itself; the enzyme and other reagents must be present in excess. More importantly, the concentration of the analyte in the sample must be adjusted to be below the K_m of the enzyme, so that there is a large change in the rate of reaction with a small change in the concentration of the analyte (region A in [Figure 48–4](#)).

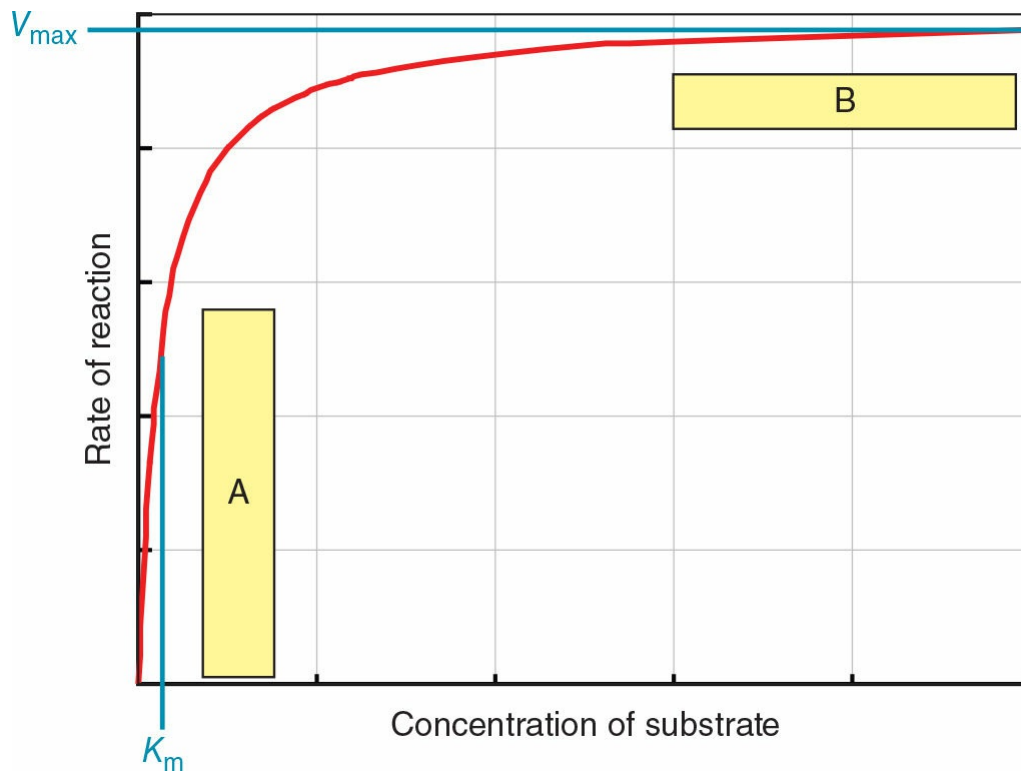

FIGURE 48–4 Use of enzymes to measure analytes and measurement of enzyme activity in biologic samples. At concentrations of substrate (analyte) at or below the K_m of the enzyme (region A in the graph), there is a very sharp increase in the rate of reaction with a small change in the concentration of analyte, so the enzyme-linked assay has greatest sensitivity over this range of concentration. At concentrations of substrate considerably above the K_m of the enzyme, as the enzyme is approaching V_{max} , (region B in the graph), it is the amount of enzyme in the sample that is limiting for the rate of formation of product, so that this is the appropriate range of substrate concentration to use for measurement of enzyme activity in a biological sample.

When cells are damaged or die, their contents leak out into the bloodstream. Measurement of enzymes in plasma can therefore be used to detect tissue damage; information is obtained from the pattern of enzymes (and tissue-specific isoenzymes) released. The extent of the increase in enzyme activity in plasma above the normal range often indicates the severity of tissue damage. When an assay is to determine the activity of an enzyme in plasma, the limiting factor must be the enzyme itself. The concentration of substrate added must be considerably in excess of the K_m of the enzyme, so that the enzyme is acting at or near V_{max} , and even a relatively large change in the concentration of substrate does not have a

significant effect on the rate of reaction (region B in Figure 48–4). In practice, this means that the concentration of substrate added is about 20-fold higher than the K_m of the enzyme.

If an enzyme has a vitamin-derived coenzyme that is essential for activity, then measurement of the activity of the enzyme in red blood cells with and without added coenzyme can be used as an index of vitamin nutritional status. This provides an indication of functional nutritional status, while measurement of the vitamin and its metabolites may reflect recent intake rather than physiological adequacy. The underlying assumption is that red blood cells have to compete with other tissues in the body for what may be a limited supply of the coenzyme. Therefore, the extent to which the red cell enzyme is saturated with its coenzyme will reflect the availability of the coenzyme over a period of time corresponding to the half-life of red cells. The assay consists of incubating two samples of the red cell lysate: one that has been preincubated with, and one without, addition of the coenzyme. Then substrate is added to both, and the activity of the enzyme is measured. In the sample preincubated without addition of the coenzyme, only that enzyme that had coenzyme bound (the holoenzyme) will be active. In the sample that was preincubated with the coenzyme, any apoenzyme (inactive enzyme protein without bound coenzyme) will have been activated to the holoenzyme. There is, therefore, always either no change in enzyme activity on addition of coenzyme, indicating complete saturation of the enzyme with coenzyme, or an increase in activity, reflecting the activation of the apoenzyme by added coenzyme. The results are reported as an enzyme **activation coefficient** (the ratio of activity in the sample preincubated with coenzyme: that without). Reference ranges for the activation coefficient are established in the same way as for any other test. Such enzyme activation assays are available for thiamin (vitamin B₁, using red cell transketolase), riboflavin (vitamin B₂, using red cell glutathione reductase), and vitamin B₆ (using one or the other of the red cell transaminases).

Competitive Ligand-Binding Assays and Immunoassays

If there is a protein that will bind the analyte, and the bound and free analyte (ligand) can be separated and measured, then it is possible to devise an assay for the analyte. Perhaps the simplest such ligand-binding

assay is that for the hormone cortisol, which is transported in the bloodstream bound to a specific cortisol-binding globulin. It is easy to prepare a plasma sample containing the binding globulin that has been stripped of its ligand (cortisol) by incubation with aluminum oxide or charcoal. This is done using a relatively large pooled plasma sample, and provides binding globulin for a large number of assays. The hormone is extracted from each sample to be analyzed, using an organic solvent, evaporated to dryness, then dissolved in ethanol and a suitable buffer, with the addition of a tracer amount of high specific activity radioactive hormone. Each sample is then incubated with the binding globulin at 37°C, then cooled to 4°C. Charcoal is added to adsorb the unbound ligand, and rapidly removed by centrifugation. The radioactivity in the supernatant is measured. This gives the amount of bound ligand, and is expressed as a percentage of the total radioactivity added to each sample. A standard curve is constructed using known amounts of hormone, so that the concentration of hormone in the samples can be determined.

A wide variety of other hormones and other analytes can be measured in the same way, by raising either monoclonal antibodies or polyclonal antisera against the analyte, for example, by injecting the analyte covalently bound to a protein into an animal. The antiserum against a hormone raised in a single rabbit can be used for many thousands of assays. Each batch of antiserum must, of course, be tested for its specificity for the hormone (ensuring that it does not also bind related hormones, especially a problem with steroid hormones), and for its sensitivity. When the binding protein is an antibody or antiserum, the assay is usually called a **radioimmunoassay**.

In a variant of the competitive binding assay, the antibody is bound covalently to the surface of beads. It is then easy to separate the bound and free ligand simply by washing the beads with ice-cold buffer, leaving the bound ligand attached to the beads for measurement of bound radioactivity. Alternatively, the antibody may be bound covalently to the surface of the test tube, or to each well in a multiwell plate. After incubation, a sample of the incubation medium is taken for measurement of the radioactivity that is not bound.

Increasingly, in order to minimize exposure to radioactive materials, fluorescently labeled ligand or antibody is used. A further development is the **sandwich assay**, in which two different antibodies against the ligand are used, each of which binds to a different region (epitope) of the analyte. The first antibody is covalently bound to the surface of each well of a multiple well plate, and the sample is added and incubated. After removal

of the incubation medium and washing each well, the second antibody is added, sandwiching the analyte between the two antibodies. The second antibody is labeled with a radioactive isotope or a fluorophore, thus permitting measurement of the bound second antibody, and hence bound ligand. In some cases, the second antibody is labeled with an enzyme, and measurement of bound second antibody, and hence bound ligand, is by measurement of the activity of the enzyme that is now bound to the wall of each cell of the plate, after washing to remove unbound second antibody and adding an excess of the enzyme substrate. This is the **enzyme-linked immunosorbent assay (ELISA)**.

Dry Chemistry Dipsticks

For a number of assays, the enzymes or antibodies and reagents can be combined on a plastic strip. For measurement of blood glucose, a finger-prick blood sample is placed on the test strip that contains glucose and the reagents shown in [Figure 48–3](#). The intensity of the blue color formed, and hence the concentration of glucose, is measured using a handheld device called the glucometer. This provides a simple and reliable method to estimate glucose at the bedside in a hospital ward, a doctor's clinic or even at home. For urine testing, several different assays can be included as separate pellets on a plastic stick called a dipstick—for example, to detect or semiquantitatively estimate levels of glucose, ketone bodies, protein, and several other analytes at the same time. Similar dipsticks are available to detect human chorionic gonadotropin (hCG) in urine, as a home pregnancy test.

Screening Neonates for Inborn Errors of Metabolism

Many of the inborn errors of metabolism can lead to very severe mental retardation if treatment is not initiated early enough. For conditions such as phenylketonuria and maple syrup urine disease, dietary restriction of the amino acids that are not metabolized normally (phenylalanine in phenylketonuria; the branched-chain amino acids leucine, isoleucine, and valine in maple syrup urine disease) is essential for management of the condition. Therefore, it is usual in most developed countries to screen neonates for such conditions. The concentration of the offending amino acid(s) is measured in a blood sample that is normally taken a week after birth, when the enzymes that are affected in the disease should have reached full expression. Most commonly, a capillary blood sample is taken by heel prick, and is blotted onto absorbent paper to be sent to the

laboratory for analysis.

The first such screening test for an inborn error of metabolism was the Guthrie bacterial inhibition test. A disk from the paper containing the blood sample is laid onto an agar plate that has been seeded with a phenylalanine-requiring strain of *Bacillus subtilis*, together with a competitive inhibitor of phenylalanine uptake into the bacteria (β -thienylalanine) at such a concentration that it will compete with phenylalanine at levels normally found in blood, so that the bacteria will not grow. If the concentration of phenylalanine is more than that usually found in blood, it will be taken up by the bacteria despite the inhibitor, and the bacteria will form visible colonies on the agar.

In most centers, the bacterial inhibition test has been superseded by chromatographic techniques that permit the detection of a variety of abnormal metabolites, and hence the detection of a variety of different inborn errors of metabolism.

ORGAN FUNCTION TESTS

Tests that provide information on the functioning of particular organs are often grouped together as organ function tests. Such grouped tests include tests of kidney, liver, and thyroid function.

Tests of Kidney Function

A complete **urinalysis** includes assessment of the physical and chemical characteristics of urine. Physical characteristics to be assessed include urine volume (this requires a timed urine sample, usually 24 hours), odor, color, appearance (clear or turbid), specific gravity, and pH. Protein, glucose, blood, ketone bodies, bile salts, and bile pigments are abnormal constituents of urine that appear in different disease conditions.

Urea and **creatinine** are excreted in urine; their serum concentrations can be used as markers of renal function because the serum concentration increases as renal function deteriorates. Creatinine is a better marker of renal function than urea because its blood concentration is not significantly affected by nonrenal factors, thus making it a specific indicator of renal function; a number of factors affect blood urea concentration.

Normally, less than 150 mg of protein, and less than 30 mg of albumin, is excreted in urine per 24 hours. This is below the limit of detection by routine tests. Presence of protein in excess of this is referred to as **proteinuria** and is a sign of renal disease. The most common cause of

proteinuria is loss of integrity of the glomerular basement membrane (glomerular proteinuria), as seen in nephrotic syndrome and diabetic nephropathy. The major protein found in glomerular proteinuria is albumin. **Microalbuminuria** is defined as the presence of 30 to 300 mg of albumin in a 24-hour urine sample. It is an early marker of renal damage in diabetes mellitus.

Even though serum creatinine is a marker of renal function, a significant increase in the blood concentration is seen only when there has been about a 50% decline in the glomerular filtration rate (GFR). Measurement of serum creatinine is therefore a test with poor sensitivity. Measurement of **creatinine clearance** gives an estimate of the GFR, and so can be used to detect the early stages of renal failure. **Clearance** is the volume of plasma from which a compound is completely cleared by the kidney in unit time. It is calculated by the formula:

$$\text{Clearance (mL/min)} = (U \times V)/P$$

where U is concentration of the measured analyte in a timed sample of urine (usually 24 hours); P is plasma concentration of the analyte; and V is volume of urine produced per minute (calculated by dividing the volume of urine collected over 24 hours by [24 × 60]).

A compound that is useful for measurement of renal clearance has a fairly constant blood concentration, is excreted only in urine, is freely filtered at the glomerulus, and is neither reabsorbed nor secreted by the renal tubules. Although creatinine clearance is commonly measured, it overestimates GFR because it is secreted by the renal tubules to a small extent. Inulin clearance satisfies all the criteria essential for a compound to be used in clearance tests. However, unlike creatinine, inulin is an exogenous compound that has to be infused intravenously at a constant rate.

Liver Function Tests

Liver function tests (LFTs) are a group of tests that help in diagnosis, assessing prognosis and monitoring therapy of liver disease. Each test assesses a specific aspect of liver function. An increase in **serum bilirubin** occurs due to many causes, and results in **jaundice**. In obstruction of the bile duct (obstructive jaundice), it is mainly conjugated bilirubin that increases. In hepatocellular disease, both conjugated and unconjugated bilirubin are elevated, reflecting the inability of the liver to take up,

conjugate, and excrete bilirubin into the bile (see [Chapter 31](#)). Total serum protein and albumin levels are low in chronic liver diseases, such as cirrhosis. Prothrombin time (see [Chapter 55](#)) may be prolonged in acute disorders of the liver because of impaired synthesis of coagulation factors.

The activities of serum alanine (ALT) and aspartate (AST) aminotransferases (see [Chapter 28](#)) are significantly elevated several days before onset of jaundice in acute viral hepatitis. ALT is considered to be more specific for liver disease than AST, because AST is elevated in cases of cardiac or skeletal muscle injury while ALT is not. Serum alkaline phosphatase activity is elevated in obstructive jaundice. A high activity of serum alkaline phosphatase is also seen in bone disease.

Thyroid Function Tests

The thyroid gland secretes the thyroid hormones—thyroxine or tetraiodothyronine (T_4) and triiodothyronine (T_3). Diseases associated with increased or decreased synthesis of thyroid hormones (hyperthyroidism and hypothyroidism, respectively) occur commonly. A clinical diagnosis of a thyroid disorder is confirmed by measurement of serum thyroid-stimulating hormone (thyrotropin, TSH) and free thyroxine and triiodothyronine. The concentration of total serum thyroxine can be affected by changes in the concentration of thyroid-binding globulin in the absence of thyroid disease. Total thyroxine is seldom measured nowadays, because assays to measure free thyroxine are available.

Adrenal Function Tests

A clinical diagnosis of adrenal hyperfunction (Cushing syndrome) or hypofunction (Addison disease) is confirmed by adrenal function tests. Secretion of cortisol from the adrenal gland shows diurnal variation; serum cortisol is highest during the early morning hours and lowest around midnight. Loss of this diurnal variation is one of the earliest signs of adrenal hyperfunction. Measurement of serum cortisol in blood samples drawn at midnight and 8 AM is, therefore, useful as a test. A diagnosis of adrenal hyperfunction is confirmed by demonstration of failure of suppression of the early morning concentration of cortisol following the administration of 1 mg dexamethasone (a potent synthetic glucocorticoid) at midnight; this is the **dexamethasone suppression test**.

Markers of Cardiovascular Risk and Myocardial

Infarction

As discussed in [Chapter 25](#), plasma total cholesterol, and especially the ratio of LDL:HDL cholesterol provides an index of the risk of developing atherosclerosis. The plasma lipoproteins were originally separated by centrifugation, hence their classification by density. Later methods involved separation by electrophoresis. Nowadays, total plasma cholesterol is measured, then lipoproteins containing apoprotein B (see [Table 25–1](#)) are precipitated using a divalent cation, allowing measurement of the cholesterol associated with high-density lipoprotein (HDL).

An electrocardiogram may not always show typical changes following a myocardial infarction. In such a situation, elevation in serum levels of cardiac troponin or creatine kinase MB isoenzyme provides confirmation of the occurrence of a myocardial infarction, as both of these proteins are specific to cardiac muscle.

SUMMARY

- Laboratory tests can provide useful information for diagnosis and treatment of disease as well as providing information about normal metabolism and the pathology of disease.
- The reference range of an analyte is the range $\pm 2 \times$ standard deviations around the mean value for the population group under consideration. Values outside this reference range are suggestive of an abnormality that merits further investigation.
- The precision of an analytical method is a measure of its reproducibility; the accuracy of a method is a measure of how close the result is to the true value.
- The sensitivity of an analytical method is a measure of how little of the analyte can be detected. The specificity is the extent to which other compounds present in the sample may give a false-positive result.
- The sensitivity of a test refers to the percentage of patients with the disease who will give a positive result. The specificity of a test is the percentage of patients without the disease who will give a negative result.
- Samples for analysis are usually blood and urine, although saliva, feces, and CSF may also be used. Blood samples may be collected in tubes containing an anticoagulant (for plasma samples) or without (for

serum samples).

- Many laboratory tests rely on production of a colored or fluorescent product that can be measured by absorption spectrophotometry or fluorimetry.
- Many compounds can be measured by high-pressure liquid chromatography, sometimes in conjunction with mass spectrometry. The measurement of a large number of analytes in a sample is the basis of metabolomics, and of metabonomics, which is the effect of a disease, drug, or other treatment on metabolism.
- Enzymes may be used to provide sensitive and specific assay methods for analytes. In this case, there must be an excess of enzyme in the sample, so that the limiting factor is the concentration of the analyte in the sample.
- Many enzymes are released into the bloodstream from dying cells in disease, and their measurement can give useful diagnostic and prognostic information. In order to determine the activity of an enzyme in a sample, there must be an excess of substrate, so that the limiting factor is the amount of enzyme present.
- Many analytes (and especially hormones) are measured by competitive binding assays, using either a naturally occurring binding protein or an antiserum or monoclonal antibody to bind the ligand. Trace amounts of high specific activity radioactive ligand, or fluorescently labelled ligand or binding protein are used.

REFERENCES

Lab Tests Online: www.labtestsonline.org (A comprehensive web site provided by the American Association of Clinical Chemists that provides accurate information on many laboratory tests).

MedlinePlus: <http://www.nlm.nih.gov/medlineplus/encyclopedia.html> (The A.D.A.M. Medical Encyclopedia includes over 4000 articles about diseases, lab tests and other matters).

Exam Questions

Section IX – Special Topics (A)

1. Which of the following will be elevated in the bloodstream about 1 to 2 hours after eating a high-fat meal?
 - A. Chylomicrons
 - B. High density lipoprotein
 - C. Ketone bodies
 - D. Nonesterified fatty acids
 - E. Very low-density lipoprotein
2. Which of the following will be elevated in the bloodstream about 4 to 5 hours after eating a high-fat meal?
 - A. Chylomicrons
 - B. High-density lipoprotein
 - C. Ketone bodies
 - D. Nonesterified fatty acids
 - E. Very low-density lipoprotein
3. Which of the following is the best definition of glycemic index?
 - A. The increase in the blood concentration of glucagon after consuming the food compared with that after an equivalent amount of white bread.
 - B. The increase in the blood concentration of glucose after consuming the food.
 - C. The increase in the blood concentration of glucose after consuming the food compared with that after an equivalent amount of white bread.
 - D. The increase in the blood concentration of insulin after consuming the food.
 - E. The increase in the blood concentration of insulin after consuming the food compared with that after an equivalent amount of white bread.
4. Which of the following will have the lowest glycemic index?
 - A. A baked apple
 - B. A baked potato
 - C. An uncooked apple

- D. An uncooked potato
 - E. Apple juice
5. Which of the following will have the highest glycemic index?
- A. A baked apple
 - B. A baked potato
 - C. An uncooked apple
 - D. An uncooked potato
 - E. Apple juice
6. Which one of the following statements concerning chylomicrons is CORRECT?
- A. Chylomicrons are made inside intestinal cells and secreted into lymph, where they acquire apolipoproteins B and C.
 - B. The core of chylomicrons contains triacylglycerol and phospholipids.
 - C. The enzyme hormone-sensitive lipase acts on chylomicrons to release fatty acids from triacylglycerol when they are bound to the surface of endothelial cells in blood capillaries.
 - D. Chylomicron remnants differ from chylomicrons in that they are smaller and contain a lower proportion of triacylglycerol.
 - E. Chylomicrons are taken up by the liver.
7. Plant sterols and stanols inhibit the absorption of cholesterol from the gastrointestinal tract. Which of the following best describes how they act?
- A. They are incorporated into chylomicrons in place of cholesterol.
 - B. They compete with cholesterol for esterification in the intestinal lumen, so that less cholesterol is esterified.
 - C. They compete with cholesterol for esterification in the mucosal cell, and unesterified cholesterol is actively transported out of the cell into the intestinal lumen.
 - D. They compete with cholesterol for esterification in the mucosal cell, and unesterified cholesterol is not incorporated into chylomicrons.
 - E. They displace cholesterol from lipid micelles, so that it is not available for absorption.

8. Which one of following statements about energy metabolism is CORRECT?
- A. Adipose tissue does not contribute to basal metabolic rate (BMR).
 - B. Physical activity level (PAL) is the sum of physical activity ratios for different activities throughout the day, multiplied by the time spent in each activity, expressed as a multiple of BMR.
 - C. Physical activity ratio (PAR) is the energy cost of physical activity throughout the day.
 - D. Resting metabolic rate (RMR) is the energy expenditure of the body when asleep.
 - E. The energy cost of physical activity can be determined by measuring respiratory quotient (RQ) production during the activity.
9. A patient with metastatic colorectal cancer has lost 6 kg of body weight over the last month. Which of the following is the best explanation for her weight loss?
- A. Because of the tumour she is oedematous.
 - B. Chemotherapy has caused nausea and loss of appetite.
 - C. Her basal metabolic rate has fallen as a result of protein catabolism caused by tumour necrosis factor and other cytokines.
 - D. Her basal metabolic rate (BMR) has increased as a result of anaerobic glycolysis in the tumour and the energy cost of gluconeogenesis from the resultant lactate in her liver.
 - E. The tumour has a very high energy requirement for cell proliferation.
10. A 5-year-old child arriving at a refugee center in East Africa is stunted in growth (only 89% of expected height for age) but not oedematous. Would you consider him to be:
- A. Suffering from kwashiorkor
 - B. Suffering from marasmic kwashiorkor
 - C. Suffering from marasmus
 - D. Suffering from undernutrition
 - E. Underfed but not considered to be clinically malnourished
11. A 5-year-old child arriving at a refugee center in East Africa is stunted in growth (only 55% of expected height for age) but not oedematous.

Would you consider him to be:

- A. Suffering from kwashiorkor
- B. Suffering from marasmic kwashiorkor
- C. Suffering from marasmus
- D. Suffering from undernutrition
- E. Underfed but not considered to be clinically malnourished

12. Which of the following is the definition of nitrogen balance?
- A. Protein intake as a percentage of total energy intake
 - B. The difference between protein intake and excretion of nitrogenous compounds
 - C. The ratio of excretion of nitrogenous compounds/protein intake
 - D. The ratio of protein intake/excretion of nitrogenous compounds
 - E. The sum of protein intake and excretion of nitrogenous compounds
13. Which one of following statements about nitrogen balance is CORRECT?
- A. If the intake of protein is greater than requirements, there will always be positive nitrogen balance.
 - B. In nitrogen equilibrium, the excretion of nitrogenous metabolites is greater than the dietary intake of nitrogenous compounds.
 - C. In positive nitrogen balance, the excretion of nitrogenous metabolites is less than the dietary intake of nitrogenous compounds.
 - D. Nitrogen balance is the ratio of intake of nitrogenous compounds/output of nitrogenous metabolites from the body.
 - E. Positive nitrogen balance means that there is a net loss of protein from the body.
14. In a series of experiments to determine amino acid requirements, healthy young adult volunteers were fed mixtures of amino acids as their sole protein source. Which of the following mixtures would lead to negative nitrogen balance (assuming that all other amino acids are provided in adequate amounts)?
- A. One lacking alanine, glycine, and tyrosine
 - B. One lacking arginine, glycine, and cysteine
 - C. One lacking asparagine, glutamine, and cysteine

- D. One lacking lysine, glycine, and tyrosine
 - E. One lacking proline, alanine, and glutamate
15. Which of the following vitamins provides the cofactor for reduction reactions in fatty acid synthesis?
- A. Folate
 - B. Niacin
 - C. Riboflavin
 - D. Thiamin
 - E. Vitamin B₆
16. Deficiency of which one of these vitamins is a major cause of blindness worldwide?
- A. Vitamin A
 - B. Vitamin B₁₂
 - C. Vitamin B₆
 - D. Vitamin D
 - E. Vitamin K
17. Deficiency of which one of these vitamins may lead to megaloblastic anaemia?
- A. Vitamin B₆
 - B. Vitamin B₁₂
 - C. Vitamin D
 - D. Vitamin E
 - E. Vitamin K
18. Which one of the following criteria of vitamin adequacy can be defined as “There are no signs of deficiency under normal conditions, but any trauma or stress reveals the precarious state of the body reserves and may precipitate clinical signs”?
- A. Abnormal response to a metabolic load
 - B. Clinical deficiency disease
 - C. Covert deficiency
 - D. Incomplete saturation of body reserves
 - E. Subclinical deficiency

19. Which one of the following criteria of vitamin adequacy can be defined as metabolic abnormalities under normal conditions?
- A. Abnormal response to a metabolic load
 - B. Clinical deficiency disease
 - C. Covert deficiency
 - D. Incomplete saturation of body reserves
 - E. Subclinical deficiency
20. Which of the following is the best definition of the reference nutrient intake (RNI) or recommended daily amount (RDA), of a vitamin or mineral?
- A. One standard deviation above the average requirement of the population group under consideration
 - B. One standard deviation below the average requirement of the population group under consideration
 - C. The average requirement of the population group under consideration
 - D. Two standard deviations above the average requirement of the population group under consideration
 - E. Two standard deviations below the average requirement of the population group under consideration
21. What percentage of the population will have met their requirement for a vitamin or mineral if their intake is equal to the RNI or RDA?
- A. 2.5%
 - B. 5%
 - C. 50%
 - D. 95%
 - E. 97.5%
22. What percentage of the population will have met their requirement for a vitamin or mineral if their intake is equal to the lower reference nutrient intake (LRNI)?
- A. 2.5%
 - B. 5%
 - C. 50%
 - D. 95%

- E. 97.5%
23. What percentage of the population will have met their requirement for a vitamin or mineral if their intake is equal to the average requirement?
- A. 2.5%
 - B. 5%
 - C. 50%
 - D. 95%
 - E. 97.5%
24. For a person whose intake of a vitamin or mineral is equal to the average requirement, what is the probability that this level of intake is adequate to meet his/her individual requirement?
- A. 2.5%
 - B. 5%
 - C. 50%
 - D. 95%
 - E. 97.5%
25. For a person whose intake of a vitamin or mineral is equal to the LRNI, what is the probability that this level of intake is adequate to meet his/her individual requirement?
- A. 2.5%
 - B. 5%
 - C. 50%
 - D. 95%
 - E. 97.5%
26. For a person whose intake of a vitamin or mineral is equal to the RNI, what is the probability that this level of intake is adequate to meet his/her individual requirement?
- A. 2.5%
 - B. 5%
 - C. 50%
 - D. 95%
 - E. 97.5%

27. Which one of the following is NOT a source of oxygen radicals?
- A. Action of superoxide dismutase
 - B. Activation of macrophages
 - C. Nonenzymic reactions of transition metal ions
 - D. Reaction of β -carotene with oxygen
 - E. Ultraviolet radiation
28. Which one of the following provides protection against oxygen radical damage to tissues?
- A. Action of superoxide dismutase
 - B. Activation of macrophages
 - C. Nonenzymic reactions of transition metal ions
 - D. Reaction of β -carotene with oxygen
 - E. Ultraviolet radiation
29. Which one of the following is NOT the result of oxygen radical action?
- A. Activation of macrophages
 - B. Modification of bases in DNA
 - C. Oxidation of amino acids in apoproteins of LDL
 - D. Peroxidation of unsaturated fatty acids in membranes
 - E. Strand breaks in DNA
30. Which of the following types of oxygen radical damage may lead to the development of autoimmune thyroid disease?
- A. Chemical modification of DNA bases in somatic cells
 - B. Chemical modification of DNA in germ-line cells
 - C. Oxidation of amino acids in cell membrane proteins
 - D. Oxidation of amino acids in mitochondrial proteins
 - E. Oxidation of unsaturated fatty acids in plasma lipoproteins
31. Which of the following types of oxygen radical damage may lead to the development of atherosclerosis and coronary heart disease?
- A. Chemical modification of DNA bases in somatic cells
 - B. Chemical modification of DNA in germ-line cells
 - C. Oxidation of amino acids in cell membrane proteins

- D. Oxidation of amino acids in mitochondrial proteins
 - E. Oxidation of unsaturated fatty acids in plasma lipoproteins
32. Which of the following types of oxygen radical damage may lead to the development of cancer?
- A. Chemical modification of DNA bases in somatic cells
 - B. Chemical modification of DNA in germ-line cells
 - C. Oxidation of amino acids in cell membrane proteins
 - D. Oxidation of amino acids in mitochondrial proteins
 - E. Oxidation of unsaturated fatty acids in plasma lipoproteins
33. Which of the following types of oxygen radical damage may lead to the development of hereditary mutations?
- A. Chemical modification of DNA bases in somatic cells
 - B. Chemical modification of DNA in germ-line cells
 - C. Oxidation of amino acids in cell membrane proteins
 - D. Oxidation of amino acids in mitochondrial proteins
 - E. Oxidation of unsaturated fatty acids in plasma lipoproteins
34. Which one of the following best explains the antioxidant action of vitamin E?
- A. It forms a stable radical that can be reduced back to active vitamin E by reaction with vitamin C.
 - B. It is a radical, so that when it reacts with another radical, a nonradical product is formed.
 - C. It is converted to a stable radical by reaction with vitamin C.
 - D. It is lipid soluble and can react with free radicals in the blood plasma resulting from nitric oxide (NO) formation by vascular endothelium.
 - E. Oxidized vitamin E can be reduced back to active vitamin E by reaction with glutathione and glutathione peroxidase.
35. Which of the following best describes the glycome?
- A. The DNA coding for glycosyltransferases
 - B. The full complement of all carbohydrates in the body
 - C. The full complement of free sugars in cells and tissues
 - D. The full complement of glycoproteins and glycolipids in the body

- E. The full complement of glycosyltransferases in the body
36. Which of the following methods CANNOT be used to determine the structures of glycoproteins?
- A. Carbohydrate microarrays
 - B. Degradation using endo- and exoglycosidases
 - C. Genome analysis
 - D. Mass spectrometry
 - E. Sepharose-lectin chromatography
37. Which of the following is NOT a function of glycoproteins?
- A. Anchoring proteins at the cell surface
 - B. Protecting plasma proteins against clearance by the liver
 - C. Providing a transport system for folate into cells
 - D. Providing a transport system for uptake of low-density lipoprotein into the liver
 - E. Providing cell surface recognition signals
38. Which of the following is NOT a constituent of glycoproteins?
- A. Fucose
 - B. Galactose
 - C. Glucose
 - D. Mannose
 - E. Sucrose
39. Which of the following is used as a sugar donor in the synthesis of the common pentasaccharide of *N*-linked glycoproteins?
- A. CMP-*N*-acetylneuraminic acid
 - B. Dolichol pyrophosphate *N*-acetylglucosamine
 - C. Dolichol pyrophosphate-mannose
 - D. GDP-fucose
 - E. UDP-*N*-acetylglucosamine
40. Which of the following is NOT used as a sugar donor in the synthesis of *N*-linked glycoproteins in the endoplasmic reticulum?
- A. Dolichol pyrophosphate fructose
 - B. Dolichol pyrophosphate galactose

- C. Dolichol pyrophosphate mannose
 - D. Dolichol pyrophosphate *N*-acetylglucosamine
 - E. Dolichol pyrophosphate *N*-acetylneuraminic acid
41. Which of the following best describes the attachment of the common pentapeptide to the apoprotein in synthesis of an *N*-linked glycoprotein?
- A. Direct glycation of the amino terminal amino acid of the peptide
 - B. Displacement of the amino terminal region of the peptide in a transamidation reaction
 - C. Displacement of the amino terminal region of the peptide in a transamination reaction
 - D. Displacement of the carboxy terminal region of the peptide in a transamidation reaction
 - E. Displacement of the carboxy terminal region of the peptide in a transamination reaction
42. Which of the following is NOT a glycoprotein?
- A. Collagen
 - B. Immunoglobulin G
 - C. Serum albumin
 - D. Thyroid-stimulating hormone
 - E. Transferrin
43. Which one of the following statements is INCORRECT?
- A. Calnexin ensures the correct folding of glycoproteins in the endoplasmic reticulum.
 - B. Dolichol-pyrophosphate oligosaccharide donates all of the sugars found in *N*-linked glycoproteins.
 - C. Mucins contain predominantly *O*-linked glycans.
 - D. *N*-Acetylneuraminic acid is commonly found at the termini of *N*-linked sugar chains of glycoproteins.
 - E. *O*-linked sugar chains of glycoproteins are built up by the stepwise addition of sugars from sugar nucleotides.
44. Which of the following is NOT an activity of cytochrome P450?
- A. Activation of vitamin D

- B. Hydroxylation of steroid hormone precursors
 - C. Hydroxylation of xenobiotics
 - D. Hydroxylation of retinoic acid
 - E. Methylation of xenobiotics
45. Which of the following best describes the reaction of a cytochrome P450?
- A. $\text{RH} + \text{O}_2 + \text{NADP}^+ \rightarrow \text{R-OH} + \text{H}_2\text{O} + \text{NADPH}$
 - B. $\text{RH} + \text{O}_2 + \text{NAD}^+ \rightarrow \text{R-OH} + \text{H}_2\text{O} + \text{NADH}$
 - C. $\text{RH} + \text{O}_2 + \text{NADPH} \rightarrow \text{R-OH} + \text{H}_2\text{O} + \text{NADP}^+$
 - D. $\text{RH} + \text{O}_2 + \text{NADPH} \rightarrow \text{R-OH} + \text{H}_2\text{O}_2 + \text{NADP}^+$
 - E. $\text{RH} + \text{O}_2 + \text{NADH} \rightarrow \text{R-OH} + \text{H}_2\text{O} + \text{NAD}^+$
46. Which of the following is the preferred lipid component of the cytochrome P450 system?
- A. Dolichol phosphate
 - B. Phosphatidylcholine
 - C. Phosphatidylethanolamine
 - D. Phosphatidylinositol
 - E. Phosphatidylserine
47. Which of the following best describes the drug interactions between phenobarbital and warfarin?
- A. Phenobarbital induces CYP2C9, and this results in decreased catabolism of warfarin.
 - B. Phenobarbital induces CYP2C9, and this results in increased catabolism of warfarin.
 - C. Phenobarbital represses CYP2C9, and this results in increased catabolism of warfarin.
 - D. Warfarin induces CYP2C9, and this results in decreased catabolism of phenobarbital.
 - E. Warfarin induces CYP2C9, and this results in increased catabolism of phenobarbital.
48. Which of the following best describes the effects of polymorphisms of

CYP2A6?

- A. People with the active allele are less likely to become tobacco-dependent smokers because this cytochrome inactivates nicotine to cotinine.
 - B. People with the inactive (null) allele are less likely to become tobacco-dependent smokers because this cytochrome inactivates nicotine to cotinine.
 - C. People with the inactive (null) allele are less likely to become tobacco-dependent smokers because this cytochrome activates nicotine to cotinine.
 - D. People with the inactive (null) allele are more likely to become tobacco-dependent smokers because this cytochrome inactivates nicotine to cotinine.
 - E. People with the inactive (null) allele are more likely to become tobacco-dependent smokers because this cytochrome activates nicotine to cotinine.
49. Which of the following is NOT a function of glutathione?
- A. Coenzyme for the reduction of hydrogen peroxide
 - B. Conjugation of bilirubin
 - C. Conjugation of some products of phase I metabolism of xenobiotics
 - D. Transport of amino acids across cell membranes
 - E. Transport of bilirubin in the bloodstream
50. Which of the following best describes the reference range for a laboratory test?
- A. A range $\pm 1 \times$ standard deviation around the mean value
 - B. A range $\pm 1.5 \times$ standard deviation around the mean value
 - C. A range $\pm 2 \times$ standard deviation around the mean value
 - D. A range $\pm 2.5 \times$ standard deviation around the mean value
 - E. A range $\pm 3 \times$ standard deviation around the mean value
51. Which of the following statements about laboratory tests is INCORRECT?
- A. The predictive value of a test is the extent to which it will correctly predict whether or not a person has the disease.

- B. The sensitivity and specificity of a test are inversely related.
 - C. The sensitivity of a test is a measure of how many people with the disease will give a positive result.
 - D. The specificity of a test is a measure of how many people with the disease will give a positive result.
 - E. The specificity of a test is a measure of how many people without the disease will give a negative result.
52. Which of the following is CORRECT when an enzyme is used to measure an analyte in a blood sample?
- A. The concentration of substrate must be about 20-times the K_m of the enzyme.
 - B. The concentration of substrate must be equal to the K_m of the enzyme.
 - C. The concentration of substrate must be equal to or lower than the K_m of the enzyme.
 - D. The concentration of the substrate in the assay is not important.
 - E. The concentration of substrate must be about 1/20th of the K_m of the enzyme.
53. Which of the following is CORRECT when an enzyme is being measured in a blood sample?
- A. The concentration of substrate must be about 20 times the K_m of the enzyme.
 - B. The concentration of substrate must be equal to the K_m of the enzyme.
 - C. The concentration of substrate must be equal to or lower than the K_m of the enzyme.
 - D. The concentration of the substrate in the assay is not important.
 - E. The concentration of substrate must be about 1/20th of the K_m of the enzyme.
54. Which of the following best explains the use of enzyme activation assays to assess vitamin nutritional status?
- A. Adding the vitamin-derived cofactor to the incubation converts previously inactive apoenzyme into active holoenzyme.

- B. Adding the vitamin-derived cofactor to the incubation converts previously inactive holoenzyme into active apoenzyme.
 - C. Adding the vitamin-derived cofactor to the incubation converts previously active holoenzyme into inactive apoenzyme.
 - D. Adding the vitamin-derived cofactor to the incubation converts previously active apoenzyme into inactive holoenzyme.
 - E. Adding the vitamin-derived cofactor to the incubation leads to a reduction in enzyme activity.
55. Which of the following would be used to prepare serum from a blood sample?
- A. A plain tube
 - B. A tube containing citrate
 - C. A tube containing EDTA
 - D. A tube containing oxalate
 - E. An evacuated tube to exclude oxygen
56. Which of the following would be used to take a blood sample for blood gas analysis?
- A. A plain tube
 - B. A tube containing citrate
 - C. A tube containing EDTA
 - D. A tube containing oxalate
 - E. An evacuated tube to exclude oxygen
57. Which of the following best explains the difference between creatinine clearance and inulin clearance as tests of renal function?
- A. Creatinine clearance is higher than inulin clearance because creatinine is actively secreted in the distal renal tubules.
 - B. Creatinine clearance is higher than inulin clearance because inulin is actively secreted in the proximal renal tubules.
 - C. Creatinine clearance is higher than inulin clearance because inulin is actively secreted in the distal renal tubules.
 - D. Creatinine clearance is lower than inulin clearance because creatinine is actively secreted in the distal renal tubules.
 - E. Creatinine clearance is lower than inulin clearance because inulin is not completely filtered at the glomerulus.

SECTION

X

Special Topics (B)

CHAPTER

49

Intracellular Traffic & Sorting of Proteins

Kathleen M. Botham, PhD, DSc & Robert K. Murray, MD, PhD

OBJECTIVES

After studying this chapter, you should be able to:

- Indicate that many proteins are targeted by signal sequences to their correct destinations and that the Golgi apparatus plays an important role in sorting proteins.
- Recognize that specialized signals are involved in sorting proteins to mitochondria, the nucleus, and to peroxisomes.
- Explain that N-terminal signal peptides play a key role in directing

newly synthesized proteins into the lumen of the endoplasmic reticulum (ER).

- Explain how chaperones prevent faulty folding of other proteins, how misfolded proteins are disposed of, and how the ER acts as a quality control compartment.
- Explain the role of ubiquitin as a key molecule in protein degradation.
- Recognize the important role of transport vesicles in intracellular transport.
- Indicate that many diseases result from mutations in genes encoding proteins involved in intracellular transport.

BIOMEDICAL IMPORTANCE

Proteins are synthesized on polyribosomes, but perform varied functions at different subcellular locations, including the cytosol, specific organelles, or membranes. Yet others are destined for export. Thus, there is considerable **intracellular traffic of proteins**. As recognized by Blobel in 1970, to enable proteins to attain their proper locations, their structure contains a signal or coding sequence that **targets** them appropriately. This led to the identification of numerous specific signals (**Table 49–1**), and also the recognition that **certain diseases** result from mutations that adversely affect these signals. This chapter will discuss the sorting and intracellular traffic of proteins and briefly consider some of the disorders that result when abnormalities occur.

TABLE 49–1 Sequences or Molecules That Direct Proteins to Specific Organelles

Targeting Sequence or Compound	Organelle Targeted
N-terminal signal peptide	ER
Carboxyl-terminal KDEL sequence (Lys-Asp-Glu-Leu) in ER-resident proteins in COPI vesicles	Lumen of ER
Diacidic sequences (eg, Asp-X-Glu) in membrane proteins in COPII vesicles	Golgi membranes
Amino terminal sequence (20-50 residues)	Mitochondrial matrix
NLS (eg, Pro ₂ -Lys ₃ -Arg-Lys-Val)	Nucleus
PTS (eg, Ser-Lys-Leu)	Peroxisome
Mannose 6-phosphate	Lysosome

MANY PROTEINS ARE TARGETED BY SIGNAL SEQUENCES TO THEIR CORRECT DESTINATIONS

The protein biosynthetic pathways in cells can be considered to be **one large sorting system**. Many proteins carry **signals** (usually but not always specific sequences of amino acids) that direct them to their specific subcellular destinations; these signals are a fundamental component of the sorting system. Usually, the signal sequences are recognized and interact with complementary areas of other proteins that serve as receptors which recognize the signals.

A major sorting decision is made early in protein biosynthesis, when specific proteins are synthesized either on **cytosolic** (free) or **membrane-bound polyribosomes** (see [Chapter 37](#)). The **signal hypothesis** was proposed by Blobel and Sabatini in 1971 partly to explain the distinction between free and membrane-bound polyribosomes. They proposed that proteins synthesized on membrane-bound polyribosomes contain an **N-terminal signal peptide**, which causes them to become attached to the membranes of the ER, and facilitates protein transfer into the ER lumen. On the other hand, proteins synthesized on free polyribosomes lack the signal peptide and retain free movement in the cytosol. An important aspect of the signal hypothesis is that **all ribosomes have the same structure**, and that the distinction between membrane-bound and free ribosomes depends solely on the former carrying proteins that have signal

peptides. Because many membrane proteins are synthesized on membrane-bound polyribosomes, the signal hypothesis plays an important role in **concepts of membrane assembly**. ER regions containing attached polyribosomes are called the **rough ER (RER)**, and the distinction between the two types of ribosomes results in two branches of the protein-sorting pathway, called the **cytosolic branch** and the **RER branch** (**Figure 49–1**).

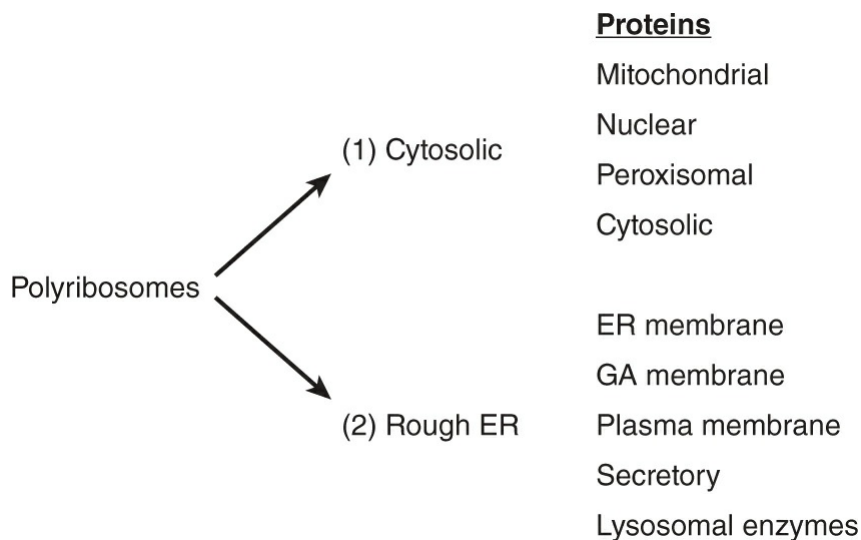

FIGURE 49–1 The two branches of protein sorting. Proteins are synthesized on cytosolic (free) polyribosomes or membrane-bound polyribosomes in the rough ER. Mitochondrial proteins encoded by nuclear genes are derived from the cytosolic pathway. (ER, endoplasmic reticulum; GA, Golgi apparatus.)

Proteins synthesized by cytosolic polyribosomes are directed to mitochondria, nuclei, and peroxisomes by specific signals, or remain in the cytosol if they lack a signal. Any protein that contains a targeting sequence that is subsequently removed is designated as a **preprotein**. In some cases, a second peptide is also removed, and in that event the original protein is known as a **prepreprotein** (eg, preproalbumin; see [Chapter 52](#)).

Proteins synthesized and sorted in the **RER branch** (**Figure 49–1**) include many destined for various membranes (eg, of the ER, Golgi apparatus [GA], plasma membrane [PM]), and also lysosomal enzymes. In addition, proteins for **export from the cell via exocytosis** (secretion) are synthesized via this route. These various proteins may thus reside in the membranes or lumen of the ER, or follow the major transport route of intracellular proteins to the GA. In the **secretory** or **exocytotic pathway**, proteins are transported from the ER → GA → PM and then released into

the external environment. Secretion may be **constitutive**, meaning that transport occurs continuously, or **regulated**, where transport is switched on and off as required. Proteins destined for the GA, the PM, certain other sites, or for constitutive secretion are carried in **transport vesicles** ([Figure 49–2](#)) (see also below). Other proteins which are subject to **regulated secretion** are carried in **secretory vesicles** ([Figure 49–2](#)). These are particularly prominent in the pancreas and certain other glands. Passage of enzymes to the lysosomes using the mannose 6-phosphate signal is described in [Chapter 46](#).

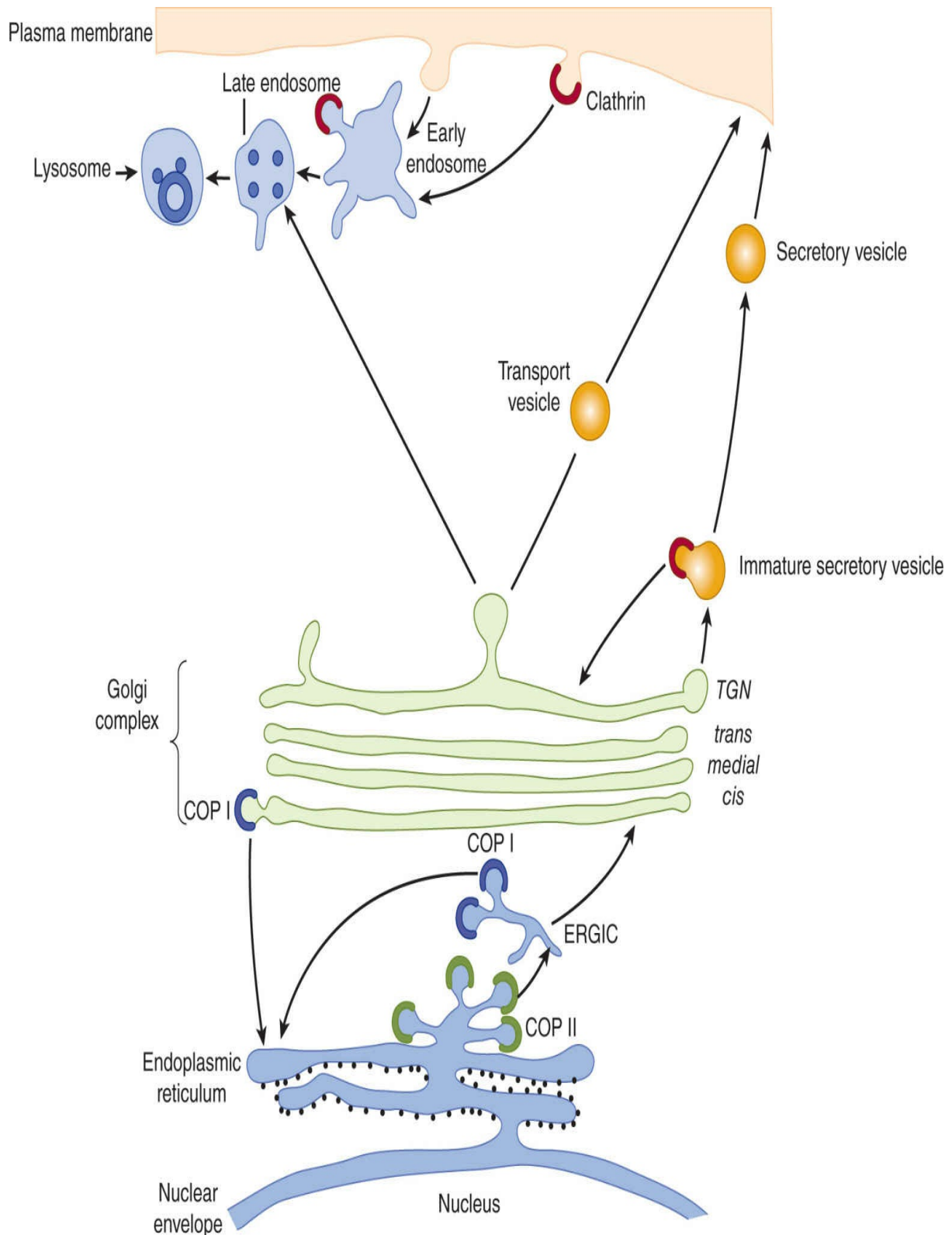

FIGURE 49–2 The rough ER branch of protein sorting. Newly synthesized proteins are inserted into the ER membrane or lumen from membrane-bound polyribosomes (small black circles studding the cytosolic face of the ER). Proteins that are transported out of the ER are carried in COPII vesicles to the *cis*-Golgi (anterograde transport). Proteins

move through the Golgi as the cisternae (membrane sac-like structures) mature. In the *trans*-Golgi network (TGN), the exit side of the Golgi, proteins are segregated and sorted. For regulated secretion, proteins accumulate in secretory vesicles, while proteins destined for insertion in the plasma membrane for constitutive secretion are carried to the cell surface in transport vesicles. Clathrin-coated vesicles are involved in endocytosis, carrying cargo to late endosomes and to lysosomes. Mannose 6-phosphate (not shown; see [Chapter 46](#)) acts as a signal for transporting enzymes to lysosomes. COPI vesicles transport protein from GA to the ER (retrograde transport) and may be involved in some intra-Golgi transport. Cargo normally passes through the ER-Golgi intermediate complex (ERGIC) compartment to the GA. (Courtesy of E Degen.)

The Golgi Apparatus Is Involved in Glycosylation & Sorting of Proteins

The **GA** plays two major roles in protein synthesis. First, it is involved in the **processing of the oligosaccharide chains** of membrane and other N-linked glycoproteins and also contains enzymes involved in O-glycosylation (see [Chapter 46](#)). Second, it is involved in the **sorting** of various proteins prior to their delivery to their appropriate intracellular destinations. **The GA consists of *cis*- (facing the ER), medial and *trans*-cisternae (membrane stacks), and the *trans*-Golgi network (TGN)** ([Figure 49–2](#)). All parts of the GA participate in the first role, whereas the TGN is particularly involved in the second and is very rich in vesicles.

Chaperones Are Proteins That Stabilize Unfolded or Partially Folded Proteins

Molecular chaperones are proteins which **stabilize unfolded or partially folded intermediates**, allowing them time to fold properly, preventing inappropriate interactions, thus combating the formation of nonfunctional structures. Most chaperones exhibit **ATPase activity** and bind ADP and ATP. This activity is important for their effect on protein folding. The ADP-chaperone complex often has a high affinity for the unfolded protein, which, when bound, stimulates the replacement of ADP with ATP. The ATP-chaperone complex, in turn, releases segments of the protein that have folded properly, and the **cycle** involving ADP and ATP binding is repeated until the protein is released. Chaperones are required for the correct targeting of proteins to their subcellular locations. A number of

important properties of these proteins are listed in [Table 49–2](#).

TABLE 49–2 Some Properties of Chaperone Proteins

- Present in a wide range of species from bacteria to humans
- Many are so-called heat shock proteins (Hsp)
- Some are inducible by conditions that cause unfolding of newly synthesized proteins (eg, elevated temperature and various chemicals)
- They bind to predominantly hydrophobic regions of unfolded proteins and prevent their aggregation
- They act in part as a quality control or editing mechanism for detecting misfolded or otherwise defective proteins
- Most chaperones show associated ATPase activity, with ATP or ADP being involved in the protein-chaperone interaction
- Found in various cellular compartments such as cytosol, mitochondria, and the lumen of the endoplasmic reticulum

Chaperonins are the second major class of chaperones. They form complex **barrel-like structures** in which an unfolded protein is sequestered away from other proteins, giving it time and suitable conditions in which to fold properly. The structure of the bacterial chaperonin **GroEL** has been studied in detail. It is polymeric, has two ring-like structures, each composed of seven identical subunits, and again ATP is involved in its action. The heat shock protein **Hsp60** is the equivalent of GroEL in eukaryotes.

THE CYTOSOLIC PROTEIN SORTING BRANCH DIRECTS PROTEINS TO SUBCELLULAR ORGANELLES

Proteins synthesized via the cytosolic sorting branch either contain an uptake signal, enabling them to be taken up into the correct subcellular organelle, or, if they are destined for the cytosol, they have no targeting signal. Specific uptake signals direct proteins to the mitochondria, nucleus, and peroxisomes ([Table 49–1](#)). Since protein synthesis is complete before transport occurs, these processes are termed posttranslational translocation.

Most Mitochondrial Proteins Are Imported

Mitochondria contain many proteins. Thirteen polypeptides (mostly membrane components of the electron transport chain) are encoded by the

mitochondrial (mt) genome and synthesized in that organelle using its own protein-synthesizing system. However, the vast majority (at least several hundreds) are encoded by **nuclear genes**, and synthesized outside the mitochondria on **cytosolic polyribosomes**, and must be imported. Most progress has been made in the study of proteins present in **the mitochondrial matrix**, such as the ATP synthase subunits (see [Chapter 13](#)). Only the pathway of import of matrix proteins will be discussed in any detail here.

Matrix proteins must pass from cytosolic polyribosomes through the **outer** and **inner mitochondrial membranes** to reach their destination. Passage through the two membranes is called **translocation**. They have an amino terminal leader sequence (**presequence**), about 20 to 50 amino acids in length ([Table 49–1](#)), which is amphipathic and contains many hydrophobic and positively charged amino acids (eg, Lys or Arg). The presequence is equivalent to a signal peptide mediating attachment of polyribosomes to membranes of the ER (see below), but in this instance **targeting proteins to the matrix**. Some general features of the passage of a protein from the cytosol to the mitochondrial matrix are shown in [Figure 49–3](#).

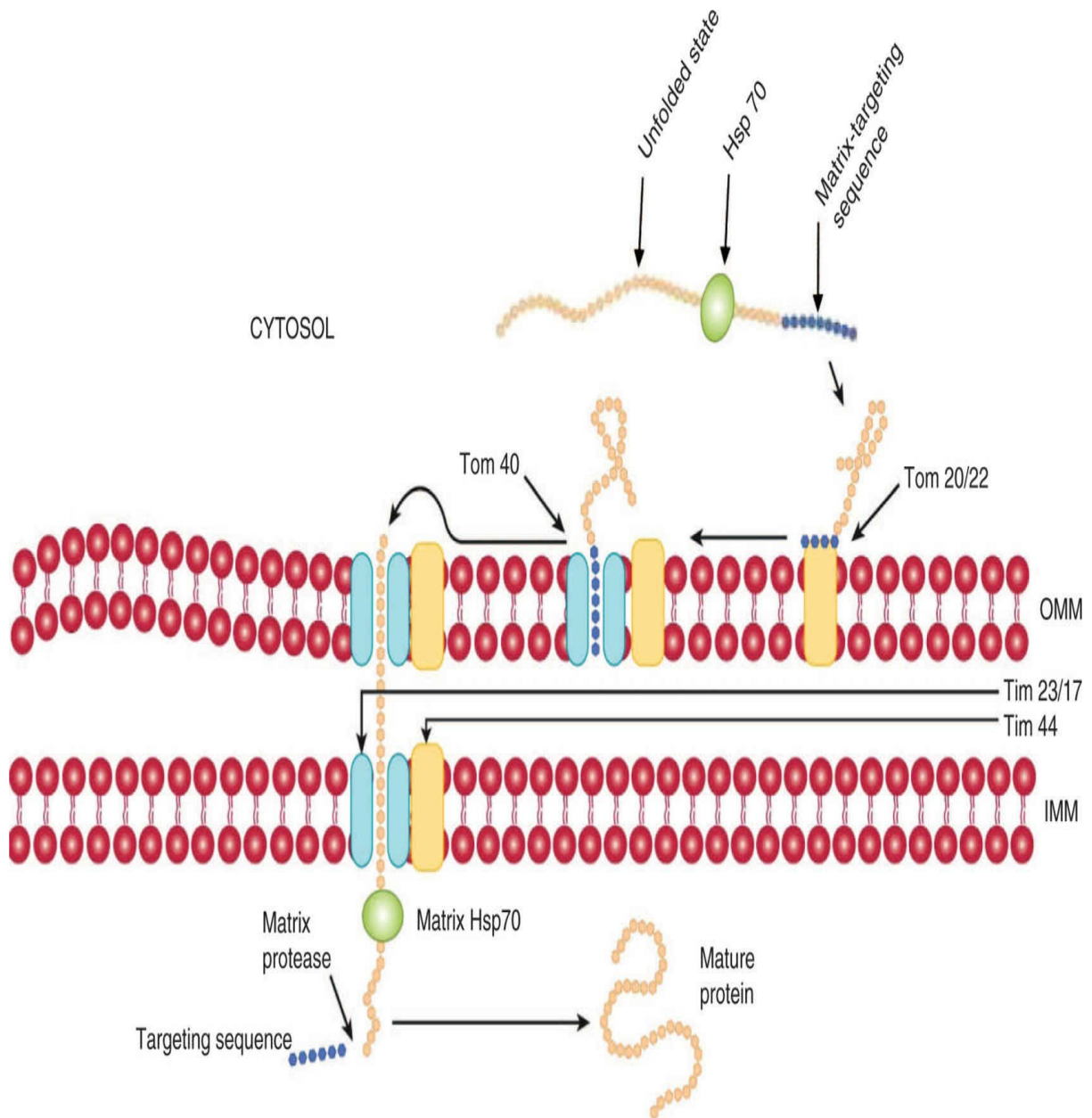

FIGURE 49–3 Entry of a protein into the mitochondrial matrix. After synthesis on cytosolic polyribosomes, an unfolded protein containing a matrix-targeting sequence interacts with the cytosolic chaperone Hsp70 and then with mitochondria (mt) via the receptor translocon of the outer membrane (Tom) 20/22. Transfer to the import channel Tom 40 followed by translocation across the outer membrane is the next step. Transport across the inner mt membrane occurs via a complex comprising Tim (translocon of the inner membrane) 23 and Tim 17 proteins. On the inside of the inner mt membrane, the protein interacts with the matrix chaperone Hsp 70, which in turn interacts with membrane protein Tim 44. The hydrolysis of ATP by mt Hsp70 probably helps drive the translocation, as does the electronegative interior of the matrix. The targeting sequence is

subsequently cleaved by the matrix protease, and the imported protein assumes its final shape, sometimes with the prior aid of interaction with an mt chaperonin. At the site of translocation, the outer and inner mt membranes are in close contact. OMM, outer mitochondrial membrane; IMM, inner mitochondrial membrane. (Modified, with permission, from Lodish H, et al: *Molecular Cell Biology*, 6th ed. W.H. Freeman & Co, 2008.)

Translocation occurs **posttranslationally**, after the matrix preproteins are released from the cytosolic polyribosomes. Interactions with a number of cytosolic proteins that act as **chaperones** (see below) and as **targeting factors** occur prior to translocation.

Two distinct **translocation complexes** are situated in the outer and inner mitochondrial membranes, referred to (respectively) as **translocase of the outer membrane (TOM)** and translocase of the inner membrane (**TIM**). Each complex has been analyzed and found to be composed of a number of proteins, some of which act as **receptors** (eg, **Tom20/22**) for the incoming proteins and others as **components** (eg, **Tom40**) of the **transmembrane pores** through which these proteins must pass. Proteins must be in the **unfolded state** to pass through the complexes, and this is made possible by **ATP-dependent binding to several chaperone proteins** including **Hsp70** (Figure 49–3). In mitochondria, chaperones are involved in translocation, sorting, folding, assembly, and degradation of imported proteins. A **proton-motive force** across the inner membrane is required for import; it is made up of the **electric potential** across the membrane (inside negative) and the **pH gradient** (see Chapter 13). The positively charged leader sequence may be helped through the membrane by the negative charge in the matrix. In addition, close apposition at **contact sites** between the outer and inner membranes is necessary for translocation to occur.

The presequence is split off in the matrix by a **matrix protease**. Contact with **other chaperones** present in the matrix is essential to complete the overall process of import. Interaction with mt-Hsp70 (mt = mitochondrial; Hsp = heat shock protein; 70 = ~70 kDa) ensures proper import into the matrix and prevents misfolding or aggregation, while interaction with the mt-Hsp60–Hsp10 system ensures proper folding. The interactions of imported proteins with the above chaperones require **hydrolysis of ATP** to drive them.

The above describes the major pathway of proteins destined for the mitochondrial matrix. However, certain proteins insert into the **outer**

mitochondrial membrane facilitated by the TOM complex. Others remain in the **intermembrane space**, and some insert into the **inner membrane**. Yet others proceed into the matrix and then return to the inner membrane or intermembrane space. A number of proteins contain two signaling sequences—one to enter the mitochondrial matrix and the other to mediate subsequent relocation (eg, into the inner membrane). Certain mitochondrial proteins do not contain presequences (eg, cytochrome *c*, which locates in the intermembrane space), and others contain **internal presequences**. Overall, proteins employ a variety of mechanisms and routes to attain their final destinations in mitochondria.

General features that apply to the import of proteins into organelles, including mitochondria and some of the other organelles to be discussed below, are summarized in **Table 49–3**.

TABLE 49–3 Some General Features of Protein Import to Organelles

- Import of a protein into an organelle usually occurs in three stages: recognition, translocation, and maturation.
- Targeting sequences on the protein are recognized in the cytoplasm or on the surface of the organelle.
- The protein is generally unfolded for translocation, a state maintained in the cytoplasm by chaperones.
- Threading of the protein through a membrane requires energy and organellar chaperones on the *trans* side of the membrane.
- Cycles of binding and release of the protein to the chaperone result in pulling of its polypeptide chain through the membrane.
- Other proteins within the organelle catalyze folding of the protein, often attaching cofactors or oligosaccharides and assembling them into active monomers or oligomers.

Transport of Macromolecules in & out of the Nucleus Involves Localization Signals

It has been estimated that more than a million macromolecules per minute are transported between the nucleus and the cytoplasm in an active eukaryotic cell. These macromolecules include histones, ribosomal proteins and ribosomal subunits, transcription factors, and mRNA molecules. The transport is bidirectional and occurs through the **nuclear pore complexes** (NPCs). These are complex structures with a mass approximately 15 times that of a ribosome and are composed of aggregates

of about 30 different proteins. The minimal diameter of an NPC is approximately 9 nm. Molecules smaller than about 40 kDa can pass through the channel of the NPC by **diffusion**, but **special translocation mechanisms** exist for larger molecules.

Here we shall mainly describe current knowledge about the **nuclear import** of certain macromolecules. The general picture that has emerged is that proteins to be imported (cargo molecules) carry a **nuclear localization signal (NLS)**. One example of an NLS is the amino acid sequence (Pro)₂-(Lys)₃-Arg-Lys-Val ([Table 49–1](#)), which is markedly rich in basic residues. Depending on which NLS it contains, a cargo molecule interacts with one of a family of soluble proteins called **importins**, and the complex **docks** transiently at the NPC. Another family of proteins called **Ran** plays a critical regulatory role in the interaction of the complex with the NPC and in its translocation through the NPC. Ran proteins are small monomeric nuclear **GTPases** and, like other GTPases, exist in either GTP-bound or GDP-bound states. They are themselves regulated by **guanine nucleotide exchange factors (GEFs)**, which are located in the nucleus, and Ran **GTPase-accelerating proteins (GAPs)**, which are predominantly cytoplasmic. The GTP-bound state of Ran is favored in the nucleus and the GDP-bound state in the cytoplasm. The conformations and activities of Ran molecules vary depending on whether GTP or GDP is bound to them (the GTP-bound state is active; see discussion of G-proteins in [Chapter 42](#)). The **asymmetry** between nucleus and cytoplasm—with respect to which of these two nucleotides is bound to Ran molecules—is thought to be crucial in understanding the roles of Ran in transferring complexes unidirectionally across the NPC. When **cargo molecules** are **released inside the nucleus**, the **importins recirculate to the cytoplasm** to be used again. [Figure 49–4](#) summarizes some of the principal features in the above process.

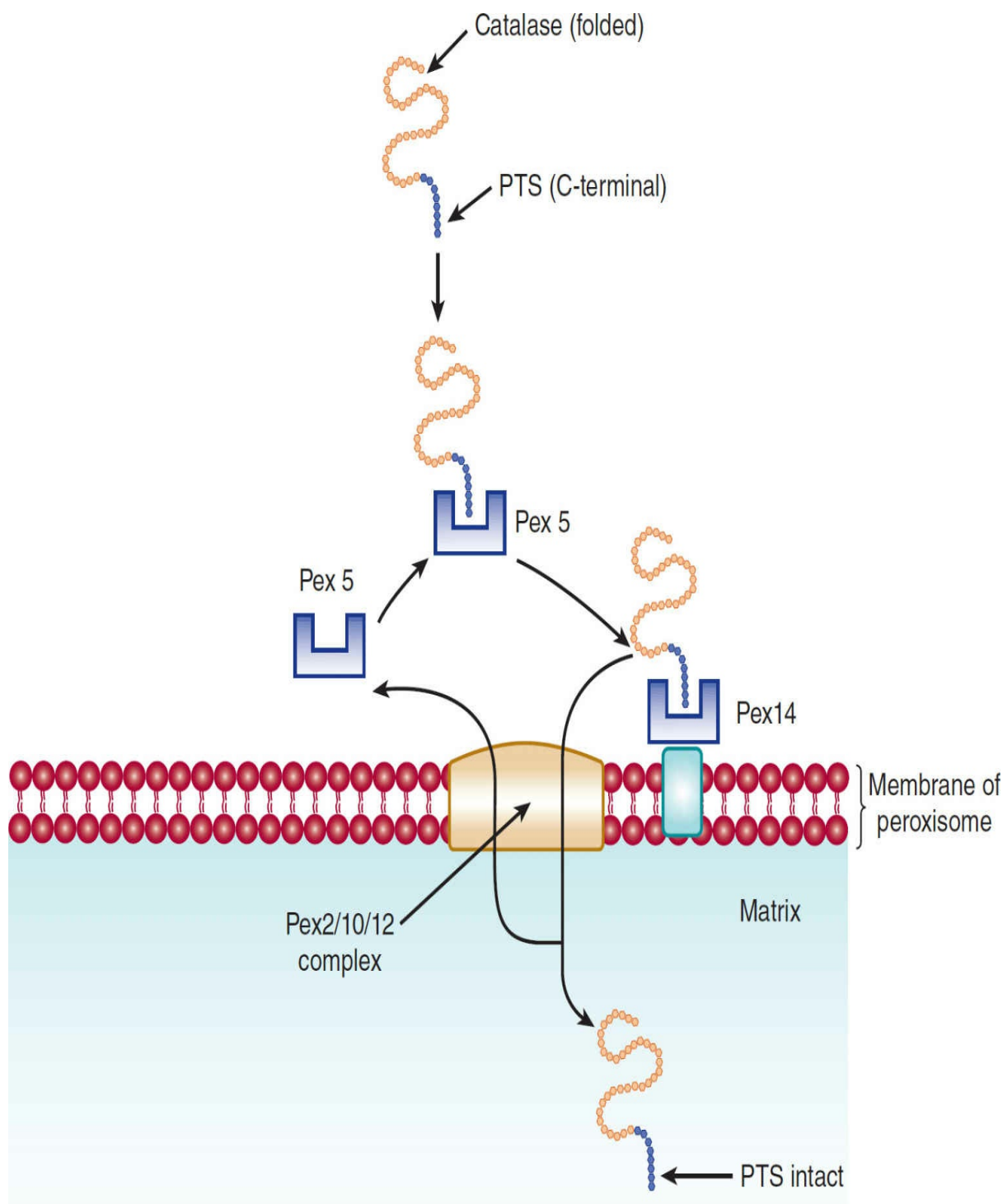

FIGURE 49–4 The entry of a protein into the nucleoplasm. A cargo molecule (C) in the cytoplasm interacts via its nuclear localization signal (NLS) to form a complex with an importin (I). (This may be either importin α or both importin α and importin β .) This complex binds to Ran (R) \cdot GDP and traverses the nuclear pore complex (NPC) into the nucleoplasm. In the nucleoplasm, Ran \cdot GDP is converted to Ran \cdot GTP by

guanine nuclear exchange factor (GEF), causing a conformational change in Ran which releases the cargo molecule. The I-Ran·GTP complex then leaves the nucleoplasm via the NPC to return to the cytoplasm. Here I is released by the action of GTPase-accelerating protein (GAP), which converts GTP to GDP, enabling it to bind to another C. The Ran·GTP is the active form of the complex, with the Ran·GDP form is inactive. Directionality is believed to be conferred on the overall process by the dissociation of Ran·GTP in the cytoplasm. (Modified, with permission, from Lodish H, et al: *Molecular Cell Biology*, 6th ed. W.H. Freeman & Co, 2008.)

Proteins similar to importins, referred to as **exportins**, are involved in the export of many macromolecules (various proteins, tRNA molecules, ribosomal subunits, and certain mRNA molecules) from the nucleus. Cargo molecules for export carry **nuclear export signals (NESs)**. Ran proteins are involved in this process also, and it is now established that the processes of import and export share a number of common features. The family of importins and exportins are referred to as **karyopherins**.

Another system is involved in the translocation of the majority of **mRNA molecules**. These are exported from the nucleus to the cytoplasm as ribonucleoprotein (RNP) complexes attached to a protein termed **mRNP exporter** that carries RNP molecules through the NPC. Ran is not involved. This system appears to use the hydrolysis of **ATP** by an RNA helicase (Dbp5) to drive translocation.

Other **small monomeric GTPases** (eg, ARF, Rab, Ras, and Rho) are important in various cellular processes such as vesicle formation and transport (ARF and Rab; see below), certain growth and differentiation processes (Ras), and formation of the actin cytoskeleton (Rho). A process involving GTP and GDP is also crucial in the transport of proteins across the membrane of the ER (see below).

Proteins Imported into Peroxisomes Carry Unique Targeting Sequences

The **peroxisome** is an important organelle involved in aspects of the metabolism of many molecules, including fatty acids and other lipids (eg, plasmalogens, cholesterol, bile acids), purines, amino acids, and hydrogen peroxide. The peroxisome is bounded by a single membrane and contains more than 50 enzymes; catalase and urate oxidase are marker enzymes for this organelle. Its proteins are **synthesized on cytosolic polyribosomes**

and fold prior to import. The pathways of import of a number of its proteins and enzymes have been studied, some being **matrix components** (**Figure 49–5**) and others **membrane components**. At least two **peroxisomal–matrix targeting sequences (PTSs)** have been discovered. One, **PTS1**, is a tripeptide (ie, Ser-Lys-Leu [SKL], but variations of this sequence have been detected) located at the carboxyl terminal of a number of matrix proteins, including catalase. Another, **PTS2**, is a nine amino acid sequence at the N-terminus and has been found in at least four matrix proteins (eg, thiolase). Neither of these two sequences is cleaved after entry into the matrix. Proteins containing PTS1 sequences **form complexes** with a cytosolic receptor protein (**Pex5**) and proteins containing PTS2 sequences complex with another receptor protein (**Pex7**). The resulting complexes then interact with a membrane receptor complex, **Pex2/10/12**, which translocates them into the matrix. Proteins involved in further transport of proteins into the matrix are also present. Pex5 is recycled to the cytosol. Most **peroxisomal membrane proteins** have been found to contain neither of the above two targeting sequences, but seem to contain others. The import system can handle **intact oligomers** (eg, tetrameric catalase). Import of **matrix proteins** requires **ATP**, whereas import of **membrane proteins** does **not**.

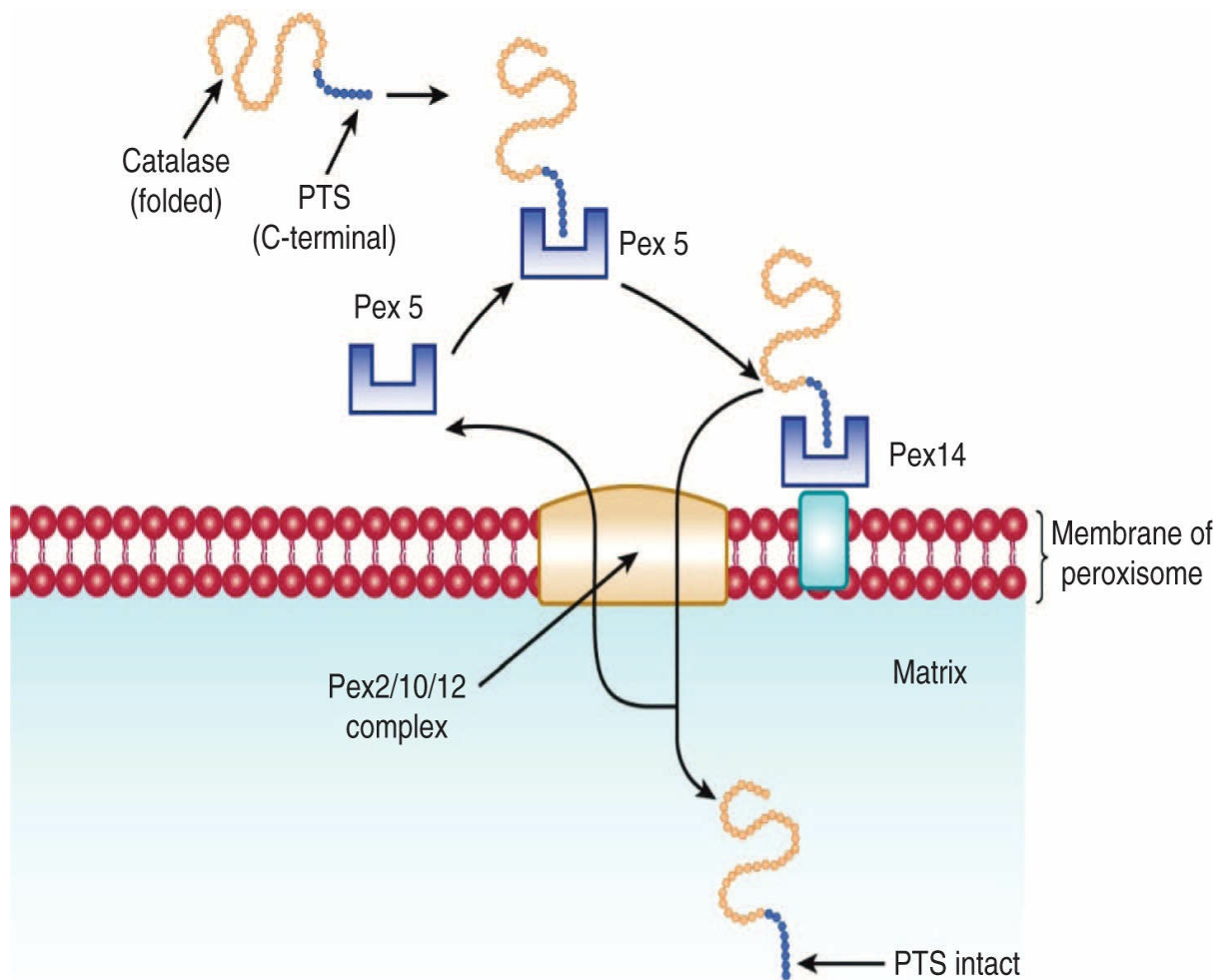

FIGURE 49–5 Entry of a protein into the peroxisomal matrix. The protein for import into the matrix is synthesized on cytosolic polyribosomes, assumes its folded shape prior to import, and contains a C-terminal peroxisomal-targeting sequence (PTS). This binds to the cytosolic receptor protein Pex5, and the complex then interacts with a receptor on the peroxisomal membrane, Pex14. In turn, the protein-Pex 14 complex is passed to the Pex 2/10/12 complex on the peroxisomal membrane and is translocated. Pex 5 is returned to the cytosol. The protein retains its PTS in the matrix. (Modified, with permission, from Lodish H, et al: *Molecular Cell Biology*, 6th ed. W.H. Freeman & Co, 2008.)

Most Cases of Zellweger Syndrome Are due to Mutations in Genes Involved in the Biogenesis of Peroxisomes

Interest in import of proteins into peroxisomes has been stimulated by studies on **Zellweger syndrome**. This condition is apparent at birth and is

characterized by **profound neurologic impairment**, victims often dying within a year. The number of peroxisomes can vary from being almost normal to being virtually absent in some patients. Biochemical findings include an accumulation of very-long-chain fatty acids, abnormalities of the synthesis of bile acids, and a marked reduction of plasmalogens. The condition is usually caused by **mutations** in genes encoding certain proteins—the PEX family of genes, also called **peroxins**—involved in various steps of **peroxisome biogenesis** (such as the import of proteins described above), or in genes encoding certain peroxisomal enzymes themselves. Two closely related conditions are **neonatal adrenoleukodystrophy** and **infantile Refsum disease**. Zellweger syndrome and these two conditions represent a **spectrum** of overlapping features, with Zellweger syndrome being the **most severe** (many proteins affected) and infantile Refsum disease the least severe (only one or a few proteins affected). **Table 49–4** lists these and related conditions.

TABLE 49–4 Disorders due to Peroxisomal Abnormalities

	OMIM Number ^a
Zellweger syndrome	214100
Neonatal adrenoleukodystrophy	202370
Infantile Refsum disease	266510
Hyperpipecolic acidemia	239400
Rhizomelic chondrodysplasia punctata	215100
Adrenoleukodystrophy	300100
Pseudoneonatal adrenoleukodystrophy	264470
Pseudo-Zellweger syndrome	261515
Hyperoxaluria type 1	259900
Acatlasemia	115500
Glutaryl-CoA oxidase deficiency	231690

PROTEINS SORTED VIA THE ROUGH ER BRANCH HAVE N-TERMINAL SIGNAL PEPTIDES

As indicated above, the **RER branch** is the second of the two branches involved in the synthesis and sorting of proteins. In this branch, proteins have **N-terminal signal peptides** and are synthesized on **membrane-bound polyribosomes**. They are usually **translocated into the lumen** of the rough ER prior to further sorting (Figure 49–2). Certain membrane proteins, however, are transferred directly into the membrane of the ER without reaching its lumen.

Some characteristics of N-terminal signal peptides are summarized in **Table 49–5**.

TABLE 49–5 Some Properties of Signal Peptides Directing Proteins to the ER

- Usually, but not always, located at the amino terminal
- Contain approximately 12-35 amino acids
- Methionine is usually the amino-terminal amino acid
- Contain a central cluster (~6-12) of hydrophobic amino acids
- The region near the N-terminus usually carries a net positive charge
- The amino acid residue at the cleavage site is variable, but residues -1 and -3 relative to the cleavage site must be small and neutral

There is much **evidence to support** the signal hypothesis, confirming that N-terminal signal peptides are involved in the process of protein translocation across the ER membrane. For example, mutant proteins containing altered signal peptides in which hydrophobic amino acids are replaced by hydrophilic ones are not inserted into the lumen of the ER. On the other hand, nonmembrane proteins (eg, α -globin) to which signal peptides have been attached by genetic engineering can be inserted into the lumen of the ER, or even secreted.

Translocation of Proteins to the Endoplasmic Reticulum May Be Cotranslational or Posttranslational

Most nascent proteins are transferred across the ER membrane into the lumen by the **cotranslational pathway**, so called because the process occurs during ongoing protein synthesis. The process of elongation of the remaining portion of the protein being synthesized probably facilitates passage of the nascent protein across the lipid bilayer. It is important that

proteins be kept in an **unfolded state** prior to entering the conducting channel—otherwise, they may not be able to gain access to the channel. The pathway involves a number of specialized proteins, including the **signal recognition particle (SRP)**, the **SRP receptor (SRP-R)**, and the **translocon**. The translocon consists of three membrane proteins (the Sec61 complex) that form a **protein-conducting channel** in the ER membrane through which the newly synthesized protein may pass. The channel **opens only when a signal peptide is present**. Closure of the channel when proteins are not being translocated prevents ions such as calcium and other molecules leaking through it, causing cell dysfunction. The process proceeds in five steps summarized below and in **Figure 49–6**.

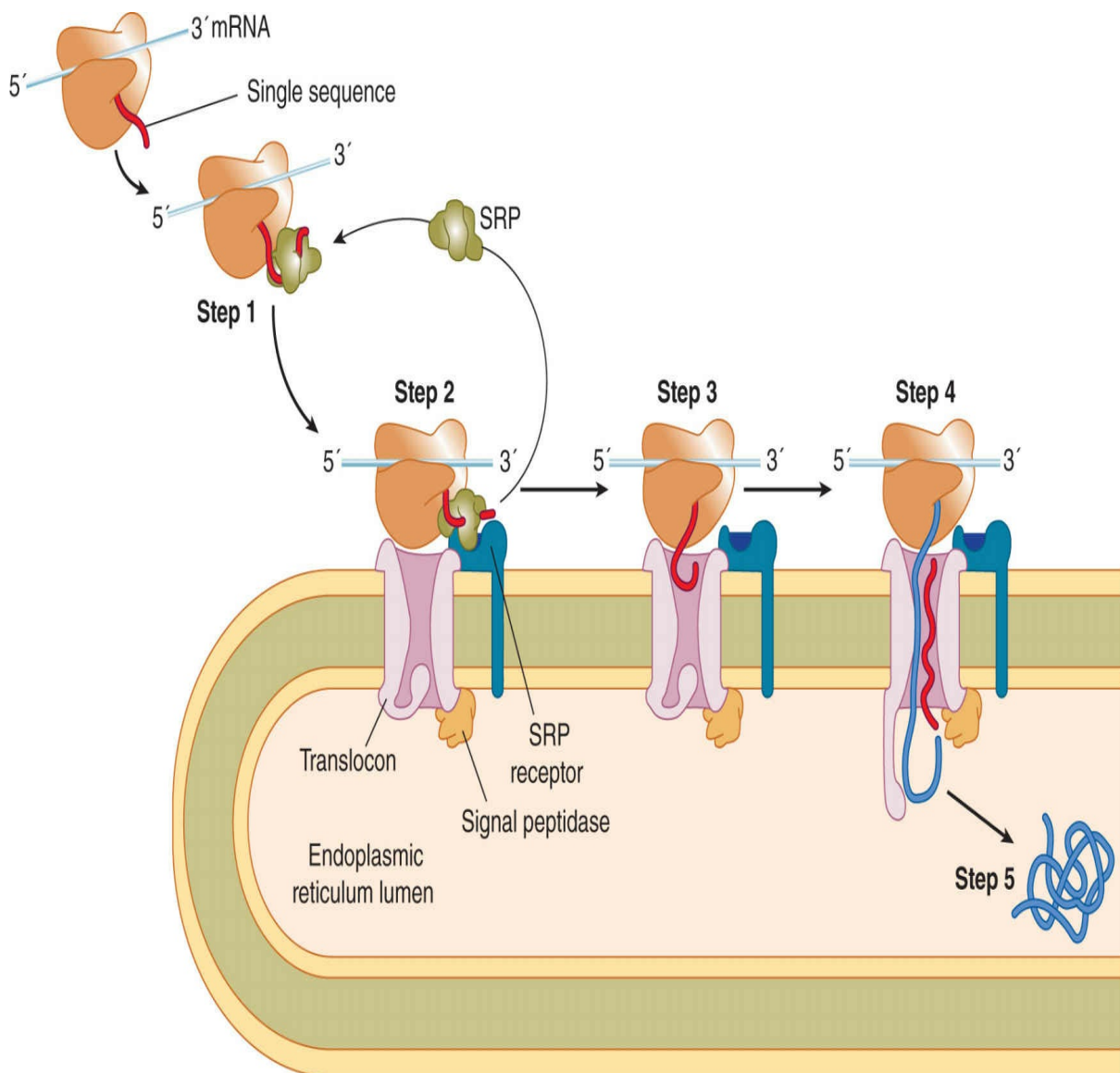

FIGURE 49–6 Cotranslational targeting of secretory proteins to the ER. **Step 1:** As the signal sequence emerges from the ribosome, it is

recognized and bound by the signal recognition particle (SRP) and translation is arrested. **Step 2:** The SRP escorts the complex to the ER membrane where it binds to the SRP receptor (SR). **Step 3:** The SRP is released, the ribosome binds to the translocon, translation resumes, and the signal sequence is inserted into the membrane channel. **Step 4:** The signal sequence opens the translocon and the growing polypeptide chain is translocated across the membrane. **Step 5:** Cleavage of the signal sequence by signal peptidase releases the polypeptide into the lumen of the ER. (Reproduced, with permission, from Cooper GM, Hausman RE: *The Cell: A Molecular Approach*. Sinauer Associates, Inc, 2009.)

Step 1: The signal sequence emerges from the ribosome and binds to the **SRP**. The SRP contains **six proteins** associated with an RNA molecule, and each of these plays a role (eg, binding of another molecule) in its function. This step temporarily stops further elongation of the polypeptide chain (elongation arrest) after some 70 amino acids have been polymerized.

Step 2: The SRP-ribosome-nascent protein complex travels to the ER membrane, where it binds to the **SRP-R**, an ER membrane protein composed of two subunits. The α subunit (SPR-R α) binds the SRP complex and the membrane-spanning β subunit (SPR-R β) anchors SPR-R α in the ER membrane. The SRP guides the complex to the SRP-R, preventing premature expulsion of the growing polypeptide into the cytosol.

Step 3: The SRP is released, translation resumes, the ribosome binds to the **translocon (Sec 61 complex)**, and the signal peptide inserts into the channel in the translocon. SRP and both subunits of the SRP-R bind **GTP**, this enables their interaction, resulting in the hydrolysis of GTP. SRP then dissociates from SRP-R and is released, and the ribosome binds to the translocon, allowing the signal peptide to enter it.

Step 4: The signal peptide induces opening of the channel in the translocon, by causing the plug (shown at the bottom on the translocon in [Figure 49–6](#)) to move. The growing polypeptide is then fully translocated across the membrane, driven by its ongoing synthesis.

Step 5: Cleavage of the signal peptide by **signal peptidase** occurs, and the fully translocated polypeptide/protein is released into the lumen of the ER. The signal peptide is degraded by proteases. Ribosomes are released from the ER membrane and dissociate into their two types of subunits.

Secretory proteins and **soluble proteins destined for organelles distal to the ER** completely traverse the membrane bilayer and are

discharged into the lumen. Many secretory proteins are N-glycosylated. **N-Glycan chains**, if present, are added by the enzyme **oligosaccharide:protein transferase** (see [Chapter 46](#)) as these proteins traverse the inner part of the ER membrane—a process called **cotranslational glycosylation**. Subsequently, these glycoproteins are found in the **lumen of the Golgi apparatus**, where further changes in glycan chains occur (see [Chapter 46](#)) prior to intracellular distribution or secretion.

In contrast, proteins destined to be embedded in **membranes of the ER** or in **other membranes** along the secretory pathway only **partially translocate** across the ER membrane (steps 1-4, above). They are able to insert into the ER membrane by lateral transfer through the wall of the translocon (see below).

Posttranslational translocation of proteins to the ER does occur in eukaryotes, although it is less common than the cotranslational route. The process ([Figure 49–7](#)) involves the Sec61 translocon complex, the **Sec62/Sec63 complex** which is also membrane bound, and chaperone proteins of the Hsp70 family. Some of these prevent the protein folding in the cytosol, but one of them, **binding immunoglobulin protein (BiP)**, is inside the ER lumen. The protein to be translocated initially binds to the translocon, and cytosolic chaperones are released. The leading end of the peptide then binds to BiP in the lumen. ATP bound to BiP interacts with Sec62/63, ATP is hydrolyzed to ADP providing energy to move the protein forwards, while the bound BiP-ADP prevents its moving backward into the cytosol. It can then be pulled through by sequential binding of BiP molecules and ATP hydrolysis. When the entire protein has entered to lumen, ADP is exchanged for ATP, allowing BiP to be released. In addition to its function in protein sorting to the ER lumen, BiP **promotes proper folding by preventing aggregation** and will temporarily bind abnormally folded immunoglobulin heavy chains and many other proteins, preventing them from leaving the ER.

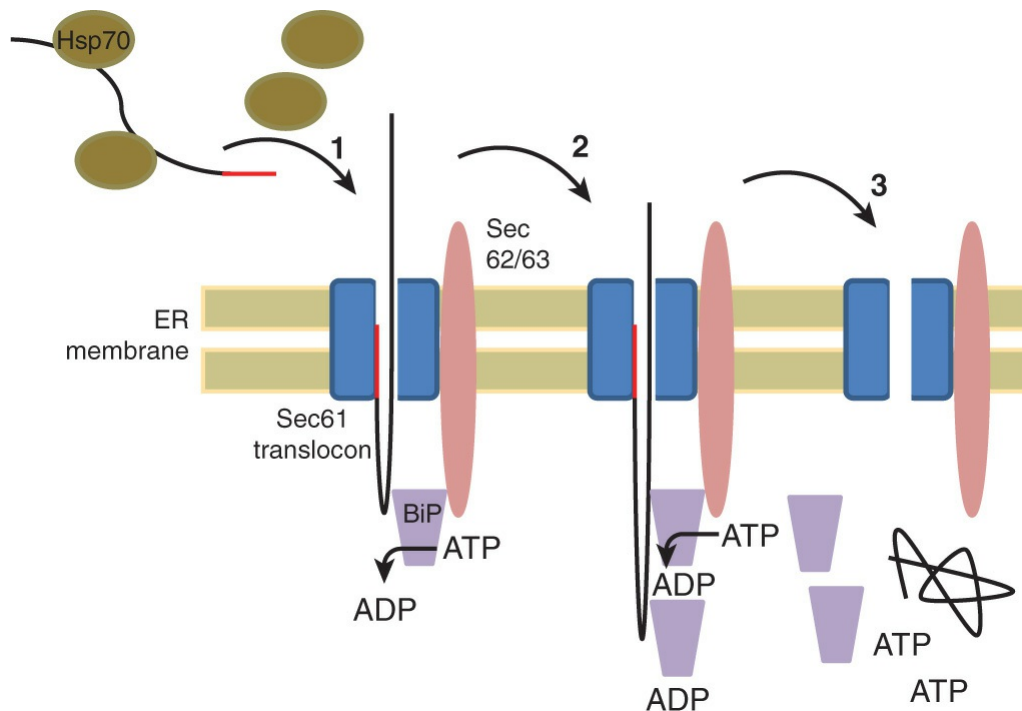

FIGURE 49–7 Posttranslational translocation of proteins into the ER.

1. Proteins synthesized in the cytosol are prevented from folding by chaperone proteins such as members of the Hsp70 family. The N-terminal signal sequence inserts into the Sec61 translocon complex and the cytosolic chaperones are released. BiP interacts with the protein and the Sec62/63 complex and its bound ATP is hydrolyzed to ADP. 2. The protein is prevented from moving back into the cytosol by the bound BiP and successive binding of BiP and ATP hydrolysis pulls the protein into the lumen. 3. When the whole protein is inside, ADP is exchanged for ATP and BiP is released.

There is evidence that the ER membrane is involved in **retrograde transport** of various molecules from the ER lumen **to the cytosol**. These molecules include unfolded or misfolded glycoproteins, glycopeptides, and oligosaccharides. At least some of these molecules are **degraded in proteasomes** (see below). The involvement of the translocon in retrotranslocation is not clear; one or more other channels may be involved. Whatever the case, there is **two-way traffic** across the ER membrane.

PROTEINS FOLLOW SEVERAL ROUTES TO BE INSERTED INTO OR ATTACHED TO THE MEMBRANES OF THE ENDOPLASMIC

RETICULUM

The routes that proteins follow to be inserted into the membranes of the ER include cotranslational insertion; posttranslational insertion; retention in the GA followed by retrieval to the ER; and retrograde transport from the GA.

Cotranslational Insertion Requires Stop Transfer Sequences or Internal Insertion Sequences

Figure 49–8 shows a variety of ways in which proteins are distributed in membranes. In particular, the **amino termini** of certain proteins (eg, the low-density lipoprotein [LDL] receptor) can be seen to be on the extracytoplasmic face, whereas for other proteins (eg, the asialoglycoprotein receptor) the **carboxyl termini** are on this face. These dispositions are explained by the initial biosynthetic events at the ER membrane. Proteins like the **LDL receptor** enter the ER membrane in a manner analogous to a secretory protein (**Figure 49–6**); they partly traverse the ER membrane, the signal peptide is cleaved, and their amino terminal protrudes into the lumen (see also **Figure 49–14**). However, this type of protein contains a highly hydrophobic segment which acts as a **halt- or stop-transfer signal** and causes its retention in the membrane (**Figure 49–9**). This sequence has its N-terminal end in the ER lumen and the C-terminal in the cytosol; the stop-transfer signal forms the single transmembrane segment of the protein and is its membrane-anchoring domain. The protein is believed to exit the translocon into the membrane by a lateral gate which opens and closes continuously allowing hydrophobic sequences to enter the lipid bilayer.

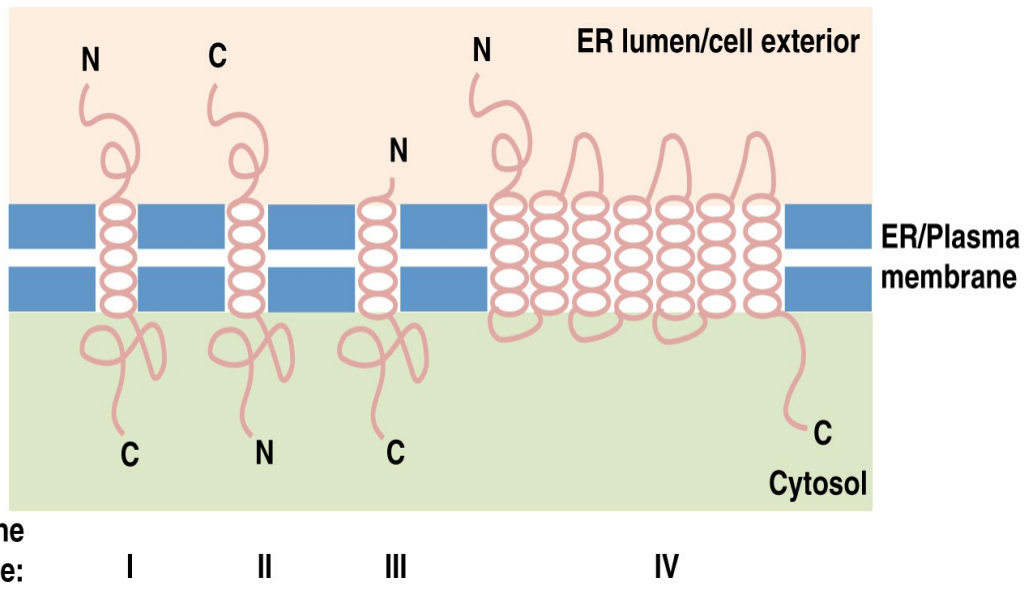

FIGURE 49–8 Variations in the way in which proteins are inserted into membranes. This schematic representation illustrates a number of possible orientations. The orientations form initially in the ER membrane, but are retained when vesicles bud off and fuse with the plasma membrane, so that the terminal initially facing the ER lumen always faces the outside of the cell. Type I transmembrane proteins (eg, the LDL receptor and influenza hemagglutinin) cross the membrane once and have their amino termini in the ER lumen/cell exterior. Type II transmembrane proteins (eg, the asialoglycoprotein and transferrin receptors) also cross the membrane once, but have their C-termini in the ER lumen/cell exterior. Type III transmembrane proteins (eg, cytochrome P450, an ER membrane protein) have a disposition similar to type I proteins, but do not contain a cleavable signal peptide. Type IV transmembrane proteins (eg, G-protein-coupled receptors and glucose transporters) cross the membrane a number of times (7 times for the former and 12 times for the latter); they are also called polytopic membrane proteins. (C, carboxyl terminal; N, amino terminal.)

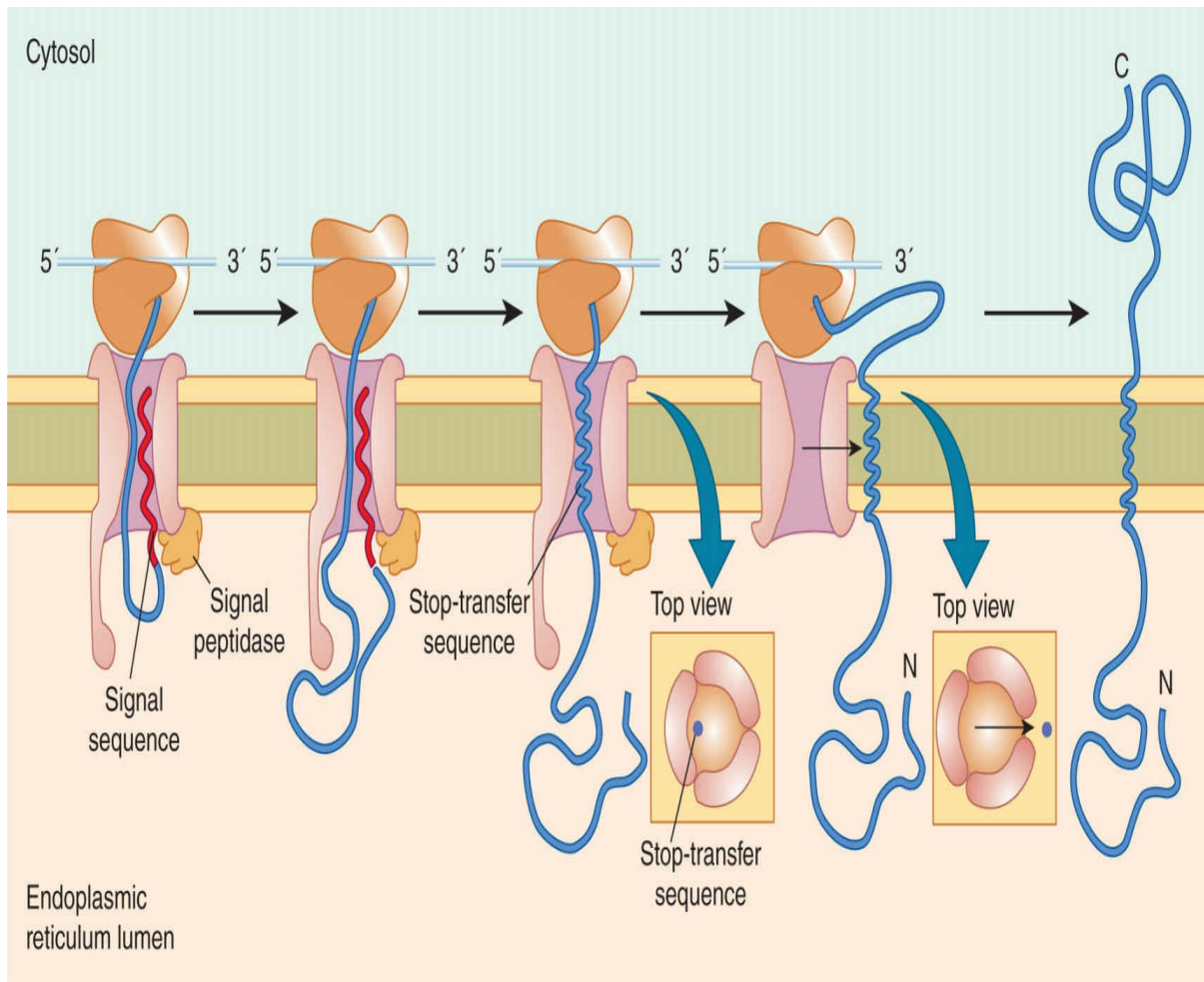

FIGURE 49–9 Insertion of a membrane protein with a cleavable signal sequence and a single stop-transfer sequence. The signal sequence is cleaved as the polypeptide chain crosses the membrane, so the amino terminus of the polypeptide chain is exposed in the ER lumen. However, translocation of the polypeptide chain across the membrane is halted when the translocon recognizes a transmembrane stop-transfer sequence. This allows the protein to exit the channel via a lateral gate and become anchored in the ER membrane. Continued translation results in a membrane-spanning protein with its carboxy terminus on the cytosolic side. (Reproduced with permission from Cooper GM, Hausman RE: *The Cell: A Molecular Approach*. Sinauer Associates, Inc, 2009.)

The small patch of ER membrane in which the newly synthesized LDL receptor is located subsequently buds off as a component of a transport vesicle which eventually fuses with the plasma membrane so that the C-terminal faces the cytosol and the N-terminal faces the outside of the cell (Figure 49–14). In contrast, the **asialoglycoprotein receptor** lacks a cleavable N-terminal signal peptide, but possesses an **internal insertion**

sequence, which inserts into the membrane but is not cleaved. This acts as an anchor, and its C-terminus is extruded through the membrane into the ER lumen. Cytochrome P450 is anchored in a similar way, but its N-terminal, rather than C-terminal, is extruded into the lumen. The more complex disposition of a **transmembrane transporter** (eg, for glucose) which may cross the membrane up to 12 times, can be explained by the fact that alternating transmembrane α -helices act as uncleaved insertion sequences and as halt-transfer signals, respectively. Each pair of helical segments is inserted as a hairpin. Sequences that determine the structure of a protein in a membrane are called **topogenic sequences**. The LDL receptor, asialoglycoprotein receptor, and glucose transporter are examples of types I, II, and IV transmembrane proteins and are found in the plasma membrane, while cytochrome P450 is an example of a type III protein which remains in the ER membrane (Figure 49–8).

Some Proteins Are Synthesized on Free Polyribosomes and Attach to the Endoplasmic Reticulum Membrane Posttranslationally

Proteins may enter the ER membrane posttranslationally through the lateral gate in the translocon in a similar way to cotranslationally sorted molecules. An example is **cytochrome b5**, which appears to enter the ER membrane subsequent to translation, assisted by several chaperones.

Other Routes Include Retention in the GA With Retrieval to the ER and Also Retrograde Transport From the GA

A number of proteins possess the amino acid sequence **KDEL** (Lys-Asp-Glu-Leu) at their carboxyl terminal (Table 49–1). KDEL-containing proteins first travel to the **GA** in **vesicles coated with coat protein II (COPII)** (see below). This process is known as **anterograde vesicular transport**. In the GA, they interact with a specific KDEL receptor protein, which retains them transiently. They then **return to the ER in vesicles coated with COPI (retrograde vesicular transport)**, where they dissociate from the receptor, and are thus retrieved. HDEL sequences (H = histidine) serve a similar purpose. The above processes result in net localization of certain soluble proteins to the ER lumen.

Certain other **non-KDEL-containing proteins** also pass to the Golgi

and then return, by retrograde vesicular transport, to the ER to be inserted therein. These include vesicle components that must be recycled, as well as certain ER membrane proteins. These proteins often possess a C-terminal signal located in the cytosol rich in basic residues.

Thus, proteins reach the ER membrane by a **variety of routes**, and similar pathways are likely to be used for other membranes (eg, the mitochondrial membranes and the plasma membrane). Precise targeting sequences have been identified in some instances (eg, KDEL sequences).

The topic of membrane biogenesis is discussed further later in this chapter.

THE ER FUNCTIONS AS THE QUALITY CONTROL COMPARTMENT OF THE CELL

After entering the ER, newly synthesized proteins fold with the assistance of chaperones and folding enzymes, and their folding status is monitored by chaperones and also enzymes (**Table 49–6**).

TABLE 49–6 Some Chaperones and Enzymes Involved in Folding That Are Located in the Rough Endoplasmic Reticulum

- BiP (immunoglobulin heavy-chain binding protein)
- GRP94 (glucose-regulated protein)
- Calnexin
- Calreticulin
- PDI (protein disulfide isomerase)
- PPI (peptidyl prolyl *cis-trans* isomerase)

The chaperone **calnexin** is a calcium-binding protein located in the ER membrane. This protein binds a wide variety of proteins, including major histocompatibility complex (MHC) antigens and a variety of plasma proteins. As described in **Chapter 46**, calnexin binds the monoglucosylated species of glycoproteins that occur during processing of glycoproteins, retaining them in the ER until the glycoprotein has folded properly.

Calreticulin, which is also a calcium-binding protein, has properties similar to those of calnexin, but it is not membrane-bound. In addition to chaperones, two enzymes in the ER lumen are concerned with proper folding of proteins. **Protein disulfide isomerase (PDI)** promotes **rapid formation** and reshuffling of disulfide bonds until the correct set is achieved. **Peptidyl prolyl isomerase (PPI)** accelerates folding of proline-containing proteins by catalyzing the *cis*–*trans* isomerization of X-Pro

bonds, where X is any amino acid residue.

Misfolded or incompletely folded proteins interact with chaperones, which retain them in the ER and prevent them from being exported to their final destinations. If such interactions continue for a prolonged period of time, harmful buildup of misfolded proteins is avoided by **ER-associated degradation (ERAD)**. In a number of genetic diseases, such as cystic fibrosis, misfolded proteins are retained in the ER, and in some cases, the retained proteins still exhibit some functional activity. As discussed later in this Chapter, drugs that will interact with such proteins and promote their correct folding and export out of the ER are currently under investigation.

MISFOLDED PROTEINS UNDERGO ENDOPLASMIC RETICULUM–ASSOCIATED DEGRADATION

Maintenance of **homeostasis in the ER** is important for normal cell function. Perturbation of the unique environment within the lumen of the ER (eg, by changes in ER Ca^{2+} , alterations of redox status, exposure to various toxins or some viruses), can lead to reduced protein folding capacity and the accumulation of misfolded proteins. The accumulation of misfolded proteins in the ER is referred to as **ER stress**. The **unfolded protein response (UPR)** is a mechanism within cells which senses the levels of misfolded proteins and activates intracellular signaling mechanisms to restore ER homeostasis. The UPR is initiated by **ER stress sensors**, which are transmembrane proteins embedded in the ER membrane. Their activation causes three principal effects: (1) transient inhibition of translation so that the synthesis of new proteins is reduced, (2) induction of transcription to increase the expression of ER chaperones, and (3) increased synthesis of proteins involved in the degradation of misfolded ER proteins (discussed below). Thus, the UPR increases the ER folding capacity and prevents a buildup of unproductive and potentially toxic protein products, as well as promoting other responses to restore cellular homeostasis. However, if impairment of folding persists, cell death pathways (apoptosis) are activated. A more complete understanding of the UPR is likely to provide new approaches to treating diseases in which ER stress and defective protein folding occur (**Table 49–7**).

TABLE 49–7 Some Conformational Diseases That Are Caused by

Abnormalities in Intracellular Transport of Specific Proteins and Enzymes due to Mutations^a

Disease	Affected Protein
α_1 -Antitrypsin deficiency with liver disease	α_1 -Antitrypsin
Chediak-Higashi syndrome	Lysosomal trafficking regulator
Combined deficiency of factors V and VIII	ERGIC53, a mannose-binding lectin
Cystic fibrosis	CFTR
Diabetes mellitus (some cases)	Insulin receptor (α -subunit)
Familial hypercholesterolemia, autosomal dominant	LDL receptor
Gaucher disease	β -Glucosidase
Hemophilia A and B	Factors VIII and IX
Hereditary hemochromatosis	HFE
Hermansky-Pudlak syndrome	AP-3 adaptor complex β 3A subunit
I-cell disease	<i>N</i> -acetylglucosamine 1-phosphotransferase
Lowe oculocerebrorenal syndrome	PIP ₂ 5-phosphatase
Tay-Sachs disease	β -Hexosaminidase
von Willebrand disease	von Willebrand factor

Proteins that misfold in the ER are degraded by the ERAD pathway (**Figure 49–10**). This process selectively transports both luminal and membrane proteins **back across the ER (retrograde translocation or dislocation)** into the cytosol where they are degraded in **proteasomes** (see **Chapter 28**). **Chaperones** present in the lumen of the ER (eg, BiP) help to target misfolded proteins to proteasomes.

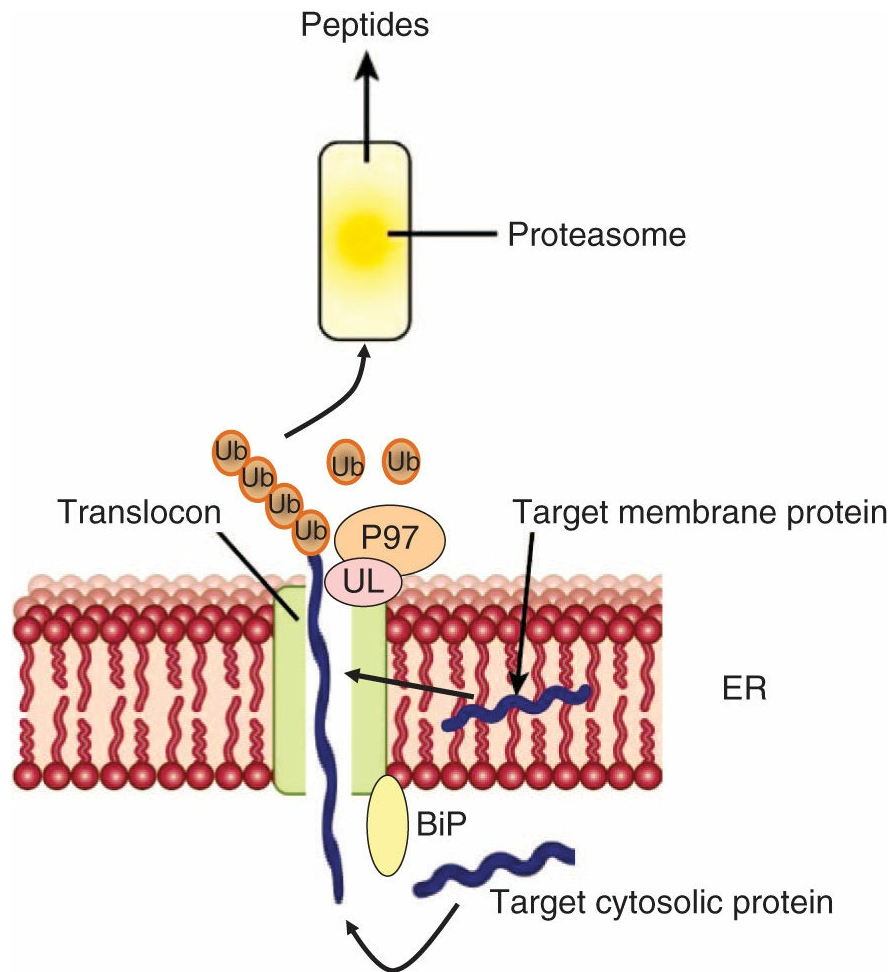

FIGURE 49–10 Simplified scheme of the events in ERAD. An ER target protein which is misfolded either in the lumen or in the membrane undergoes retrograde transport into the cytosol via a translocon which is made up of a number of proteins, typically including Sec61, Derlin, Hrd1, and Sel1L. Chaperone proteins such as BiP target misfolded proteins for retrotranslocation. As the protein enters the cytosol, it is ubiquitinated by ubiquitin ligases (UL), pulled out of the membrane by P97, an AAA-ATPase, and delivered to the proteasome with the aid of ubiquitin receptor chaperones. Inside the proteasome it is degraded to small peptides that may have several fates after exit.

The assembly of the retrotranslocation translocon comprising a number of proteins is initiated by recognition of misfolded proteins. Various types of translocons are thought to occur, but a typical one may include Sec61, Derlin, Hrd1, and Sel1L. As retrotranslocation occurs, misfolded proteins are polyubiquitinated (see Chapter 28) by ubiquitin ligases on the cytosolic side, and are then pulled from the membrane by **P97**, an **AAA-ATPase** (ATPase associated with various cellular activities) and delivered to the

proteasome for degradation with the help of ubiquitin receptor chaperones.

Ubiquitin Is a Key Molecule in Protein Degradation

There are two major pathways of protein degradation in eukaryotes. One involves **lysosomal proteases** and does not require ATP, but the major pathway involves **ubiquitin** and is ATP-dependent. The ubiquitin pathway is particularly associated with **disposal of misfolded proteins and regulatory enzymes that have short half-lives**. Ubiquitin is known to be involved in diverse important physiologic processes including **cell cycle regulation** (degradation of cyclins), **DNA repair, inflammation and the immune response** (see [Chapter 52](#)), **muscle wasting, viral infections**, and **many others**. Ubiquitin is a small (76 amino acids), highly conserved protein that tags various proteins for degradation in proteasomes. The mechanism of attachment of ubiquitin to a target protein (eg, a misfolded form of cystic fibrosis transmembrane conductance regulator [CFTR], the protein involved in the causation of cystic fibrosis; see [Chapter 40](#)) is shown in [Figure 28–2](#) and the process is described in detail in [Chapter 28](#).

Ubiquitinated Proteins Are Degraded in Proteasomes

Polyubiquitinated target proteins enter **proteasomes** located in the cytosol. Proteasomes are protein complexes with a relatively **large cylindrical structure** and are composed of four rings with a hollow **core** containing the protease active sites, and one or two **caps** or **regulatory particles** that recognize the polyubiquitinated substrates and initiate degradation ([Figures 28–3](#) and [28–4](#)). Target proteins are unfolded by ATPases present in the proteasome caps. Proteasomes can hydrolyze a very wide variety of peptide bonds. Target proteins pass into the core to be degraded to small peptides, which then exit the proteasome to be further degraded by cytosolic peptidases. Both normally and abnormally folded proteins are substrates for the proteasome. Liberated ubiquitin molecules are recycled. The proteasome plays an important role in **presenting small peptides** produced by **degradation of various viruses** and other molecules to **MHC class I molecules**, a key step in antigen presentation to T lymphocytes.

TRANSPORT VESICLES ARE KEY PLAYERS IN INTRACELLULAR PROTEIN TRAFFIC

Proteins that are synthesized on membrane-bound polyribosomes and are

destined for the GA or PM reach these sites inside **transport vesicles**. As indicated in **Table 49–8**, there are a number of different types of vesicles. There may be other types of vesicles still to be discovered.

TABLE 49–8 Some Types of Vesicles and Their Functions

Vesicle	Function
COPI	Involved in intra-GA transport and retrograde transport from the GA to the ER
COPII	Involved in export from the ER to either ERGIC or the GA
Clathrin	Involved in transport in post-GA locations including the PM, TGN, and endosomes
Secretory vesicles	Involved in regulated secretion from organs such as the pancreas (eg, secretion of insulin)
Vesicles from the TGN to the PM	They carry proteins to the PM and are also involved in constitutive secretion

Each vesicle has its own set of coat proteins. **Clathrin** is used in vesicles destined for exocytosis (see discussions of the LDL receptor in **Chapters 25** and **26**) and in some of those carrying cargo to lysosomes. This protein consists of three interlocking spirals, which interact to form a lattice around the vesicle. COPI and COPII, the vesicles involved in **retrograde transport** (from the GA to the ER) and **anterograde transport** (from the ER to the GA), respectively, however, are clathrin-free. Transport and secretory vesicles carrying cargo from the GA to the PM are also clathrin-free. Here we focus mainly on COPII, COPI, and clathrin-coated vesicles. Each type has a different complement of proteins in its coat. For the sake of clarity, the non-clathrin-coated vesicles are referred to in this text as **transport vesicles**. The principles concerning assembly of these different types are generally similar, although some details of assembly for COPI and clathrin-coated vesicles differ from those for COPII (see below).

Model of Transport Vesicles Involves SNAREs & Other Factors

Vesicles lie at the heart of intracellular transport of many proteins. **Genetic approaches** and **cell-free systems** have been used to elucidate the

mechanisms of vesicle formation and transport. The overall process is complex, and involves a variety of cytosolic and membrane proteins, GTP, ATP, and accessory factors. **Budding, tethering, docking, and membrane fusion** are key steps in the life cycles of vesicles, with the GTP-binding proteins, **Sar1, ARF, and Rab** acting as **molecular switches**. Sar1 is the protein involved in step 1 of formation of COPII vesicles, whereas ARF is involved in the formation of COPI and clathrin-coated vesicles. The functions of the various proteins involved in vesicle processing and the abbreviations used are shown in **Table 49–9**.

TABLE 49–9 Some Factors Involved in the Formation of Non-Clathrin-Coated Vesicles and Their Transport

- ARF: ADP-ribosylation factor, a GTPase involved in formation of COPI and also clathrin-coated vesicles.
- Coat proteins: A family of proteins found in coated vesicles. Different transport vesicles have different complements of coat proteins.
- NSF: *N*-ethylmaleimide-sensitive factor, an ATPase.
- Sar1: A GTPase that plays a key role in assembly of COPII vesicles.
- Sec12p: A guanine nucleotide exchange factor (GEF) that interconverts Sar1·GDP and Sar1·GTP.
- α -SNAP: Soluble NSF attachment protein. Along with NSF, this protein is involved in dissociation of SNARE complexes.
- SNARE: SNAP receptor. SNAREs are key molecules in the fusion of vesicles with acceptor membranes.
- t-SNARE: Target SNARE.
- v-SNARE: Vesicle SNARE.
- Rab proteins: A family of Ras-related proteins (monomeric GTPases) first observed in rat brain. They are active when GTP is bound. Different Rab molecules dock different vesicles to acceptor membranes.
- Rab effector proteins: A family of proteins that interact with Rab molecules; some act to tether vesicles to acceptor membranes.

There are common general steps in transport vesicle formation, vesicle targeting, and fusion with a target membrane, irrespective of the membrane, the vesicle forms from or its intracellular destination. The nature of the coat proteins, GTPases and targeting factors differ depending on where the vesicle forms from and its eventual destination. Anterograde transport from the ER to the Golgi involving COPII vesicles is the best studied example. The process can be considered to occur in eight steps (**Figure 49–11**). The basic concept is that each transport vesicle is loaded

with specific cargo and also one or more **v-SNARE** proteins that direct targeting. Each target membrane bears one or more **complementary t-SNARE proteins** with which v-SNAREs interact, mediating SNARE protein-dependent vesicle–membrane fusion. In addition, **Rab proteins** also help direct the vesicles to specific membranes and their tethering at a target membrane.

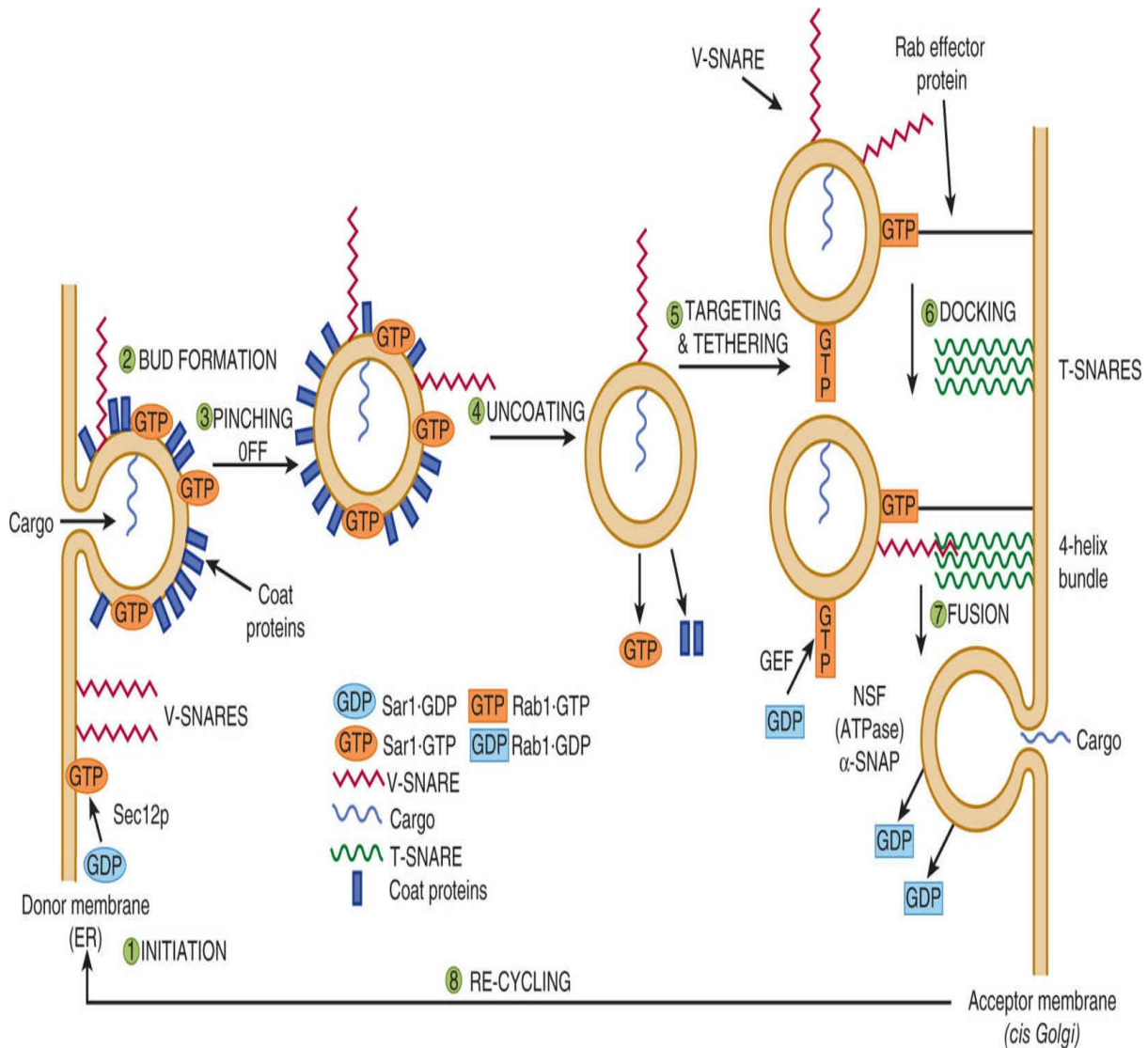

FIGURE 49–11 Model of the steps in a round of anterograde transport involving COPII vesicles. Step 1: Sar1 is activated when GDP exchanged for GTP and it becomes embedded in the ER membrane to form a focal point for bud formation. **Step 2:** Coat proteins bind to Sar1·GTP and cargo proteins become enclosed inside the vesicles. **Step 3:** The bud pinches off, formatting a complete coated vesicle. Vesicles move through cells along microtubules or actin filaments. **Step 4:** The vesicle is uncoated when bound GTP is hydrolyzed to GDP by Sar1. **Step 5:** Rab

molecules are attached to vesicles after switching of Rab.GDP to Rab.GTP, a specific GEF (see [Table 49–9](#)). Rab effector proteins on target membranes bind to Rab·GTP, tethering the vesicles to the target membrane. **Step 6:** v-SNAREs pair with cognate t-SNAREs in the target membrane to form a four-helix bundle which docks the vesicles and initiates fusion. **Step 7:** When the v- and t-SNAREs are closely aligned, the vesicle fuses with the membrane and the contents are released. GTP is then hydrolyzed to GDP, and the Rab·GDP molecules are released into the cytosol. An ATPase (NSF) and α -SNAP (see [Table 49–9](#)) dissociate the four-helix bundle between the v- and t-SNAREs so that they can be reused. **Step 8:** Rab and SNARE proteins are recycled for further rounds of vesicle fusion. (Adapted, with permission, from Rothman JE: Mechanisms of intracellular protein transport. Nature 1994;372:55.)

Step 1: Budding is initiated when the GTPase **Sar1** is activated by binding of GTP in exchange for GDP via the action of the guanine nucleotide exchange factor (GEF) **Sec12p** ([Table 49–9](#)), switching it from a soluble to a membrane bound form via conformational change which exposes a hydrophobic tail. This enables it to become embedded in the ER membrane to form a focal point for vesicle assembly.

Step 2: Various **coat proteins** bind to **Sar1·GTP**. In turn, membrane cargo proteins bind to the coat proteins either **directly** or via **intermediary proteins** that attach to coat proteins, and they then become enclosed in their appropriate vesicles. Soluble cargo proteins bind to receptor regions inside the vesicles. A number of **signal sequences** on cargo molecules have been identified ([Table 49–1](#)). For example, KDEL sequences direct certain proteins in retrograde flow from the GA to the ER in COPI vesicles. Diacidic sequences (eg, Asp-X-Glu, X = any amino acid) and short hydrophobic sequences on membrane proteins destined for the GA membrane are involved in interactions with coat proteins of COPII vesicles. However, not all cargo molecules have a sorting signal. Some highly abundant secretory proteins travel to various cellular destinations in transport vesicles by **bulk flow**; that is, they enter into transport vesicles at the same concentration that they occur in the organelle. However, it appears that most proteins are actively sorted (concentrated) into transport vesicles and bulk flow is used by only a select group of cargo proteins. Additional coat proteins are assembled to **complete bud formation**. Coat proteins promote budding, contribute to the curvature of buds, and also help sort proteins.

Step 3: The **bud pinches off**, completing formation of the coated

vesicle. The curvature of the ER membrane and protein–protein and protein-lipid interactions in the bud facilitate pinching off from ER exit sites. Vesicles move through cells along **microtubules** or along **actin filaments**.

Step 4: Coat disassembly, or uncoating (involving **dissociation** of **Sar1** and the **shell** of coat proteins) follows **hydrolysis of bound GTP to GDP** by Sar1, promoted by a specific coat protein. Sar1 thus plays key roles in both assembly and dissociation of the coat proteins. **Uncoating** is necessary for fusion to occur.

Step 5: Vesicle targeting is achieved by attachment of **Rab** molecules to vesicles. Rabs are a family of Ras-like proteins required in several steps of intracellular protein transport and also in regulated secretion and endocytosis. They are **small monomeric GTPases** that attach to the cytosolic faces of budding vesicles in the **GTP-bound state** and are also present on acceptor membranes. Rab·GDP molecules in the cytosol are switched to Rab·GTP molecules by a specific GEF ([Table 49–9](#)). **Rab effector proteins** on acceptor membranes bind to Rab·GTP, but not Rab·GDP molecules, thus **tethering** the vesicles to the membranes.

Step 6: v-SNAREs pair with cognate t-SNAREs in the target membrane to **dock** the vesicles and initiate fusion. Generally, one v-SNARE in the vesicle pairs with three t-SNAREs on the acceptor membrane to form a tight **four-helix bundle**. In **synaptic vesicles** one v-SNARE is called **synaptobrevin**. **Botulinum B toxin**, one of the most lethal toxins known and the most serious cause of food poisoning contains a **protease** that binds **synaptobrevin**, thus **inhibiting release of acetylcholine** at the neuromuscular junction and often proving fatal.

Step 7: Fusion of the vesicle with the acceptor membrane occurs once the v- and t-SNAREs are closely aligned. After vesicle fusion and release of contents, GTP is hydrolyzed to GDP, and the Rab·GDP molecules are released into the cytosol. When a SNARE on one membrane interacts with a SNARE on another membrane, linking the two, this is referred to as a **trans-SNARE complex** or a **SNARE pin**. Interactions of SNAREs on the same membrane form a **cis-SNARE complex**. In order to dissociate the four-helix bundle between the v- and t-SNAREs so that they can be reused, two additional proteins are required. These are an **ATPase (NSF)** and **a-SNAP** ([Table 49–9](#)). NSF hydrolyzes ATP and the energy released dissociates the four-helix bundle making the SNARE proteins available for another round of membrane fusion.

Step 8: Certain components, such as the Rab and SNARE proteins, are **recycled** for subsequent rounds of vesicle fusion.

During the above cycle, SNARES, tethering proteins, Rab, and other proteins all collaborate to deliver a vesicle and its contents to the appropriate site.

Some Transport Vesicles Travel via the *Trans*-Golgi Network

Proteins found in the **apical** or **basolateral** areas of the plasma membranes of polarized epithelial cells may be transported to these sites in various ways; in **transport vesicles** budding from the ***trans*-Golgi network**, with different Rab proteins directing some vesicles to apical regions and others to basolateral regions; via initial direction to the basolateral membrane, followed by endocytosis and transport across the cell by **transcytosis** to the apical region; or via a process involving the **glycosylphosphatidylinositol (GPI) anchor** described in [Chapter 46](#). This structure is also often present in **lipid rafts** (see [Chapter 40](#)).

Once proteins in the secretory pathway reach the *cis*-Golgi from the ER, they may be retained in vesicles for travel through the GA to the *trans*-Golgi, or they may cross by a process called **cisternal maturation**, in which the **cisternae (the flattened membrane disks of the GA that bud off from the ER)** move and transform into one another, or perhaps in some cases **diffusion** via intracisternal connections. In this model, vesicular elements from the ER fuse with one another to help form the *cis*-Golgi, which in turn can move forward toward the *trans*-Golgi. COPI vesicles return Golgi enzymes (eg, glycosyltransferases) back from distal (*trans*-) cisternae of the GA to more proximal (*cis*) cisternae.

The Formation of COPI Vesicles Is Inhibited by Brefeldin

The fungal metabolite **brefeldin A** inhibits the formation of **COPI vesicles by preventing GTP from binding to ARF**. In its presence, the Golgi apparatus appears to **collapse into the ER**. Brefeldin A has proven to be a useful tool for examining some aspects of Golgi structure and function.

Some Proteins Undergo Further Processing While Inside Vesicles

Some proteins are subjected to further processing by **proteolysis** while

inside either transport or secretory vesicles. For example, **albumin** is synthesized by hepatocytes as **preproalbumin** (see [Chapter 52](#)). Its signal peptide is removed, converting it to **proalbumin**. In turn, proalbumin, while inside secretory vesicles, is converted to **albumin** by action of **furin** ([Figure 49–12](#)). This enzyme cleaves a hexapeptide from proalbumin immediately C-terminal to a dibasic amino acid site (ArgArg). The resulting mature albumin is secreted into the plasma. Hormones such as **insulin** (see [Chapter 41](#)) are subjected to similar proteolytic cleavages while inside secretory vesicles.

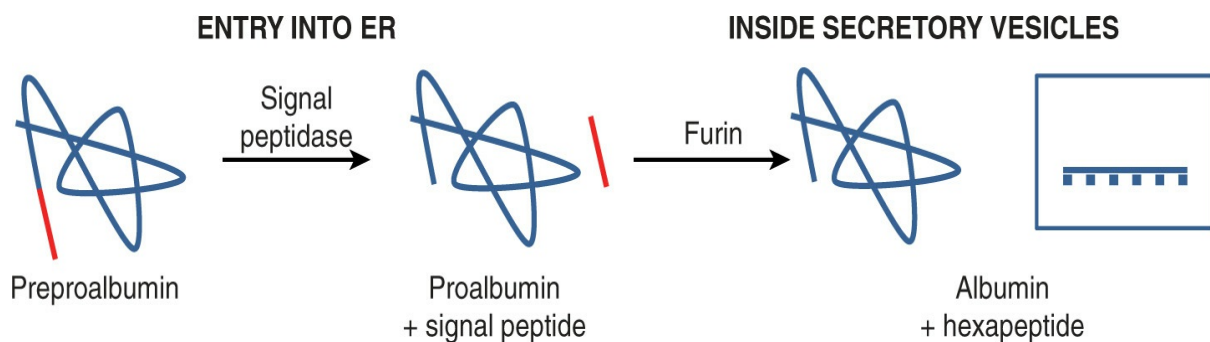

FIGURE 49–12 Processing of preproalbumin albumin. The signal peptide is removed from preproalbumin as it moves into the ER. Furin cleaves proalbumin at the C-terminal end of a basic dipeptide (ArgArg) while the protein is inside the secretory vesicle. The mature albumin is secreted into the plasma.

THE ASSEMBLY OF MEMBRANES IS COMPLEX

There are a number of different types of cell membranes, ranging from the plasma membrane which separates the cell contents from the external environment to the internal membranes of subcellular organelles, such as mitochondria and the ER. Although the general lipid bilayer structure is similar in all membranes, they differ in their specific protein and lipid content and each type has its own specific features (see [Chapter 40](#)). No satisfactory scheme describing the assembly of any one of these membranes is currently available. Vesicular transport and the way in which various proteins are initially inserted into the membrane of the ER have been discussed above. Some general points about membrane assembly are addressed below.

Asymmetry of Both Proteins & Lipids Is Maintained During Membrane Assembly

Vesicles formed from membranes of the ER and Golgi apparatus, either naturally or pinched off by homogenization, exhibit **transverse asymmetries** of both lipid and protein. These **asymmetries are maintained** during fusion of transport vesicles with the plasma membrane. The **inside** of the vesicles after fusion becomes the **outside of the plasma membrane**, and the cytoplasmic side of the vesicles remains the cytoplasmic side of the membrane (**Figure 49–13**). The enzymes responsible for the synthesis of phospholipids, the major class of lipids in membranes (see **Chapter 40**) reside in the cytoplasmic surface of the cisternae (the sac-like structures) of the ER. Phospholipids are synthesized at that site, and it is thought that they self-assemble into thermodynamically stable bimolecular layers, thereby expanding the membrane and perhaps promoting the detachment of so-called **lipid vesicles** from it. It has been proposed that these vesicles travel to other sites, donating their lipids to other membranes. **Phospholipid exchange proteins** are cytosolic proteins that take up phospholipids from one membrane and release them to another are believed to play a role in regulating the specific lipid composition of various membranes.

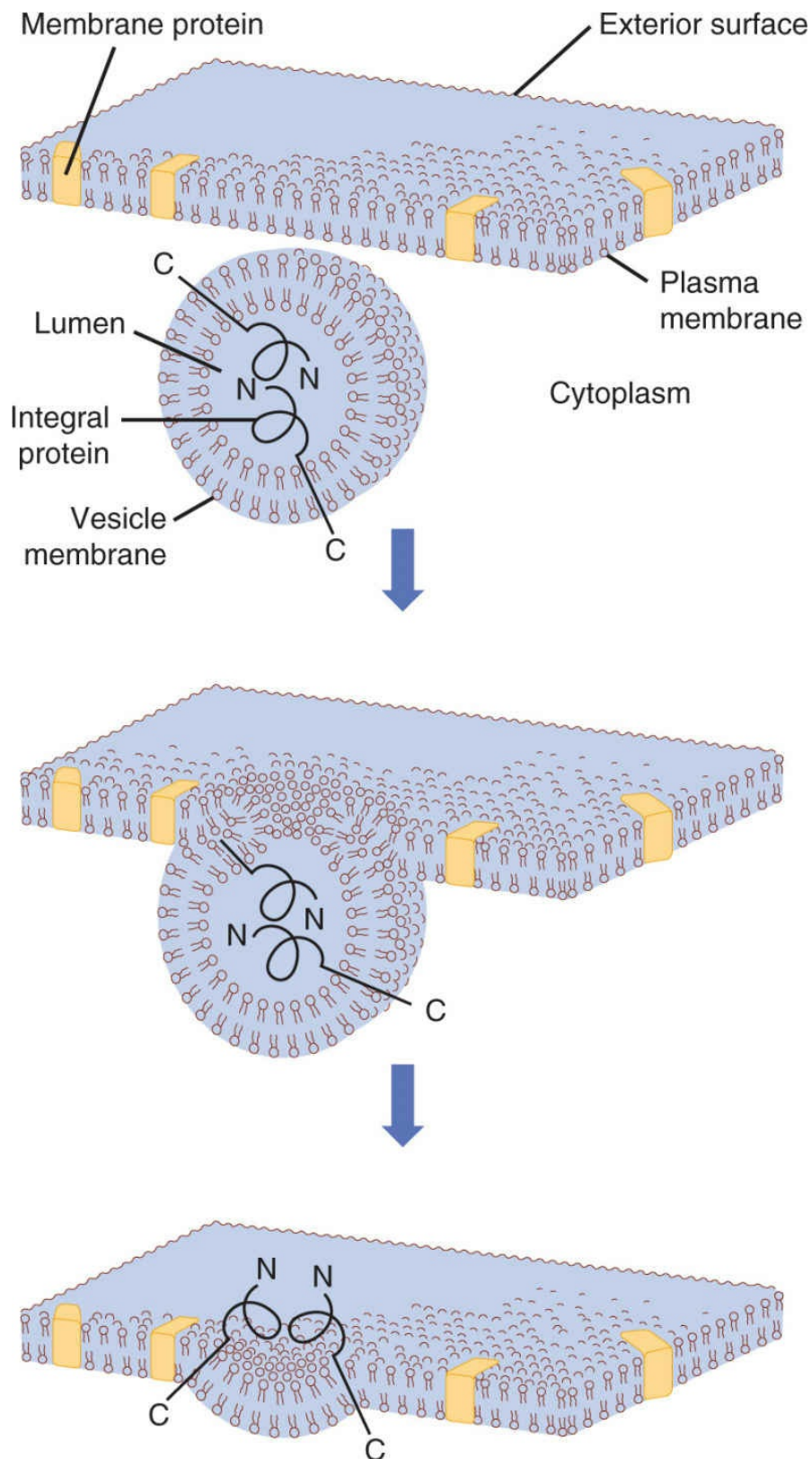

FIGURE 49–13 Fusion of a vesicle with the plasma membrane preserves the orientation of any integral proteins embedded in the vesicle bilayer. Initially, the amino terminal of the protein faces the lumen, or inner cavity, of such a vesicle. After fusion, the amino terminal

is on the exterior surface of the plasma membrane. The lumen of a vesicle and the outside of the cell are topologically equivalent. (Redrawn and modified, with permission, from Lodish HF, Rothman JE: The assembly of cell membranes. *Sci Am* [Jan] 1979;240:43.)

It should be noted that the **lipid compositions** of the ER, Golgi, and plasma membrane differ, the latter two membranes containing **higher amounts of cholesterol, sphingomyelin, and glycosphingolipids**, and **less phosphoglycerides** than does the ER. Sphingolipids pack more densely in membranes than do phosphoglycerides. These differences affect the structures and functions of membranes. For example, the **thickness of the bilayer** of the GA and PM is greater than that of the ER, which affects which particular transmembrane proteins are found in these organelles. Also, **lipid rafts** (see [Chapter 40](#)) are believed to be formed in the GA.

Lipids & Proteins Undergo Turnover at Different Rates in Different Membranes

It has been shown that the half-lives of the lipids of the ER membranes are generally shorter than those of its proteins, so that the **turnover rates of lipids and proteins are independent**. Indeed, different lipids have been found to have different half-lives. Furthermore, the half-lives of the proteins of these membranes vary widely, some exhibiting short (hours) and others long (days) half-lives. Thus, individual lipids and proteins of the ER membranes appear to be inserted into it relatively independently and this is believed to be the case for many other membranes.

The biogenesis of membranes is thus a complex process about which much remains to be learned. One indication of the complexity involved is to consider the number of **posttranslational modifications** that membrane proteins may be subjected prior to attaining their mature state. These may include disulfide formation, proteolysis, assembly into multimers, glycosylation, addition of a glycosphosphatidylinositol (GPI) anchor, sulfation on tyrosine or carbohydrate moieties, phosphorylation, acylation, and prenylation. Nevertheless, significant progress has been made; [Table 49–10](#) summarizes some of the major features of membrane assembly that have emerged to date.

TABLE 49–10 Some Major Features of Membrane Assembly

- Lipids and proteins are inserted independently into membranes.
- Individual membrane lipids and proteins turn over independently and at different rates.
- Topogenic sequences (eg, signal [amino terminal or internal] and stop-transfer) are important in determining the insertion and disposition of proteins in membranes.
- Membrane proteins inside transport vesicles bud off the endoplasmic reticulum on their way to the Golgi; final sorting of many membrane proteins occurs in the *trans*-Golgi network.
- Specific sorting sequences guide proteins to particular organelles such as lysosomes, peroxisomes, and mitochondria.

Various Disorders Result From Mutations in Genes Encoding Proteins Involved in Intracellular Transport

Some disorders reflecting abnormal **peroxisomal** function and abnormalities of protein synthesis in the **ER** and of the synthesis of **lysosomal proteins** have been listed earlier in this chapter (see [Tables 49–4](#) and [49–7](#), respectively). Many other mutations affecting folding of proteins and their intracellular transport to various organelles have been reported, including neurodegenerative disorders such as Alzheimer’s disease, Huntington’s disease, and Parkinson’s disease. The elucidation of the causes of these various **conformational disorders** has contributed significantly to our understanding of **molecular pathology**. The term “**diseases of proteostasis deficiency**” has also been applied to diseases due to misfolding of proteins. Proteostasis is a composite word derived from protein homeostasis. Normal proteostasis is due to a balance of many factors, such as synthesis, folding, trafficking, aggregation, and normal degradation. If any one of these is disturbed (eg, by mutation, aging, cell stress, or injury), a variety of disorders can occur, depending on the particular proteins involved.

Potential therapies for the various diseases caused by protein dysfunction due to misfolding are aimed at correcting the conformational errors. One promising approach is to employ chaperones such as Hsp70 to promote proper folding. In addition, the antibiotic **geldanamycin** has been shown to activate heat shock proteins. Small drug molecules that act as chemical chaperones have also been shown to prevent misfolding and restore protein function. These approaches, however, have so far been tested only in animal experiments and in vitro systems and their

effectiveness in humans remains to be established.

SUMMARY

- Many proteins are targeted to their destinations by signal sequences. A major sorting decision is made when proteins are partitioned between cytosolic (or free) and membrane-bound polyribosomes by virtue of the absence or presence of an N-terminal signal peptide.
- Proteins synthesized on cytosolic polyribosomes are targeted by specific signal sequences to mitochondria, nuclei, peroxisomes, and the ER. Proteins which lack a signal remain in the cytosol.
- Proteins synthesized on membrane-bound polyribosomes initially enter the ER membrane or lumen, and many are ultimately destined for other membranes including the PM and that of the GA, for lysosomes and for secretion via exocytosis.
- Many glycosylation reactions occur in compartments of the Golgi, and proteins are further sorted in the *trans*-Golgi network.
- Molecular chaperones stabilize unfolded or partially folded proteins. Chaperones are required for the correct targeting of proteins to their subcellular locations.
- In posttranslational translocation, proteins are transported to their target organelles after their synthesis is complete. Proteins destined for mitochondria, the nucleus, and peroxisomes follow this route, as well as a minority of proteins targeted to the ER.
- Most proteins enter the ER lumen by the cotranslational pathway, where translocation occurs during ongoing protein synthesis.
- Proteins embedded in the ER membrane may be inserted cotranslationally, posttranslationally, or after transport to the GA (anterograde transport), transient retention, and return to the ER (retrograde transport).
- Harmful buildup of misfolded proteins triggers the unfolded protein response and they are degraded via the ERAD pathway. Proteins are tagged for degradation by the addition of a number of ubiquitin molecules and then enter the cytosol where they are broken down in proteasomes.
- Different types of transport vesicles are coated with different proteins. Clathrin-coated vesicles are destined for exocytosis and lysosomes, while coat proteins I and II are associated with COPI and COPII vesicles, which are responsible for retrograde and anterograde transport,

respectively.

- Transport vesicle processing is complex and requires many protein factors. Budding from the donor membrane is followed by movement through the cytosol, tethering, docking, and fusion with the target membrane.
- Certain proteins (eg, precursors of albumin and insulin) are subjected to proteolysis while inside transport vesicles, producing the mature proteins.
- Small GTPases (eg, Ran, Rab) and GEFs play key roles in many aspects of intracellular trafficking.
- Vesicles formed from membranes of the ER and Golgi apparatus are asymmetrical in both lipid and protein content. The asymmetry is maintained during assembly and during fusion of transport vesicles with the plasma membrane, so that the inside of the vesicles after fusion becomes the outside of the plasma membrane, and the cytoplasmic side of the vesicles remains facing the cytosol.
- Lipids and proteins are inserted independently and turn over at different rates. Exact details of the assembly process remain to be established.
- Many disorders have been shown to be due to mutations in genes or to other factors that affect the folding of various proteins. These conditions have been referred to as conformational diseases, or alternatively as diseases of proteostatic deficiency. Promising therapeutic approaches include the use of chaperones such as Hsp70 and small molecules that can prevent misfolding and restore protein function.

REFERENCES

- Alberts B, Johnson A, Lewis J, et al: *Molecular Biology of the Cell*, 6th ed. Garland Science, 2014. (An excellent textbook of cell biology, with comprehensive coverage of trafficking and sorting.)
- Cooper GM, Hausman RE: *The Cell: A Molecular Approach*, 7th ed. Palgrave, 2015. (An excellent textbook of cell biology, with comprehensive coverage of trafficking and sorting.)
- Hebert DN, Molinari M: In and out of the ER: protein folding, quality control, degradation and related human diseases. *Physiol Rev* 2007;87:1377.

The Extracellular Matrix

Kathleen M. Botham, PhD, DSc & Robert K. Murray, MD, PhD

OBJECTIVES

After studying this chapter, you should be able to:

- Indicate the importance of the extracellular matrix (ECM) and its components in health and disease.
- Describe the structural and functional properties of collagen and elastin, the major proteins of the ECM.
- Indicate the major features of fibrillin, fibronectin, and laminin, other important proteins of the ECM.
- Describe the properties and general features of the synthesis and degradation of glycosaminoglycans and proteoglycans, and their contributions to the ECM.
- Give a brief account of the major biochemical features of bone and cartilage.

BIOMEDICAL IMPORTANCE

Most mammalian cells are located in tissues where they are surrounded by

a complex **extracellular matrix (ECM)** often referred to as “**connective tissue**,” which protects the organs and also provides elasticity where required (eg, in blood vessels, lungs, and skin). The ECM contains three major classes of biomolecules: **structural proteins**, for example, **collagen, elastin, and fibrillin**; certain **specialized proteins** such as **fibronectin** and **laminin**, which form a mesh of fibers that are embedded in the third class, **proteoglycans**. The ECM is involved in many processes, both normal and pathologic, for example, it plays important roles in development, in inflammatory states, and in the spread of cancer cells. Certain components of the ECM play a part in both **rheumatoid arthritis** and **osteoarthritis**. Several diseases (eg, osteogenesis imperfecta and a number of types of the Ehlers-Danlos syndrome) are due to genetic disturbances of the synthesis of collagen, a major ECM component. Specific components of proteoglycans (the glycosaminoglycans; GAGs) are affected in the group of genetic disorders known as the **mucopolysaccharidoses**. Changes occur in the ECM during the **aging process**. This chapter describes the basic biochemistry of the three major classes of biomolecules found in the ECM and illustrates their biomedical significance. Major biochemical features of two specialized forms of ECM—bone and cartilage—and of a number of diseases involving them are also briefly considered.

COLLAGEN IS THE MOST ABUNDANT PROTEIN IN THE ANIMAL WORLD

Collagen, the major component of most connective tissues, constitutes approximately 25% of the protein of mammals. It provides an extracellular framework for all metazoan animals and exists in virtually every animal tissue. At least 28 types of collagen made up of over 30 distinct polypeptide chains (each encoded by a separate gene) have been identified in human tissues (**Table 50–1**). Although several of these are present only in small proportions, they may play important roles in determining the physical properties of specific tissues. In addition, a number of proteins (eg, the C1q component of the complement system, pulmonary surfactant proteins SPA and SPD) that are not classified as collagens have collagen-like domains in their structures; these proteins are sometimes referred to as “noncollagen collagens.”

TABLE 50–1 Types of Collagen and Their Tissue Distribution

Type	Distribution
I	Noncartilaginous connective tissues, including bone, tendon, skin
II	Cartilage, vitreous humor
III	Extensible connective tissues, including skin, lung, vascular system
IV	Basement membranes
V	Minor component in tissues containing collagen I
VI	Muscle and most connective tissues
VII	Dermal-epidermal junction
VIII	Endothelium and other tissues
IX	Tissues containing collagen II
X	Hypertrophic cartilage
XI	Tissues containing collagen II
XII	Tissues containing collagen I
XIII	Many tissues, including neuromuscular junctions and skin
XIV	Tissues containing collagen I
XV	Associated with collagens close to basement membranes in many tissues including in eye, muscle, microvessels
XVI	Many tissues
XVII	Epithelia, skin hemidesmosomes
XVIII	Associated with collagens close to basement membranes, close structural homologue of XV
XIX	Rare, basement membranes, rhabdomyosarcoma cells
XX	Many tissues, particularly corneal epithelium
XXI	Many tissues
XXII	Tissue junctions, including cartilage-synovial fluid, hair follicle-dermis
XXIII	Limited in tissues, mainly transmembrane and shed forms
XXIV	Developing cornea and bone
XXV	Brain
XXVI	Testis, ovary
XXVII	Embryonic cartilage and other developing tissues, cartilage in adults
XXVIII	Basement membrane around Schwann cells

COLLAGENS HAVE A TRIPLE HELIX STRUCTURE

All collagen types have a **triple helical structure** made up of three polypeptide chain subunits (**α chains**). In some collagens, the entire molecule is a triple helix, whereas in others only a fraction of the structure may be in this form. Mature **collagen type I** belongs to the former type; each polypeptide subunit is twisted into a left-handed polyproline helix of three residues per turn forming an α chain. Three of these are then wound into a **right-handed triple- or superhelix**, forming a rod-like molecule 1.4 nm in diameter and about 300-nm long (**Figure 50–1**). **Glycine** residues occur at every third position of the triple helical portion of the α chain. This is necessary because glycine is the only amino acid small enough to be accommodated in the limited space available in the central core of the triple helix. This **repeating structure**, represented as $(\text{Gly-X-Y})_n$, is an absolute requirement for the formation of the triple helix. While X and Y can be any other amino acids, the X positions are often proline and the Y positions are often hydroxyproline. Proline and hydroxyproline confer **rigidity** on the collagen molecule. **Hydroxyproline** is formed by the posttranslational hydroxylation of peptide-bound proline residues catalyzed by the enzyme **prolyl hydroxylase**, whose cofactors are **ascorbic acid** (vitamin C) and α -ketoglutarate. Lysines in the Y position may also be posttranslationally modified to hydroxylysine through the action of **lysyl hydroxylase**, an enzyme with similar cofactors. Some of these hydroxylysines may be further modified by the addition of galactose or galactosyl-glucose through an **O-glycosidic linkage** (see **Chapter 46**), a glycosylation site that is unique to collagen.

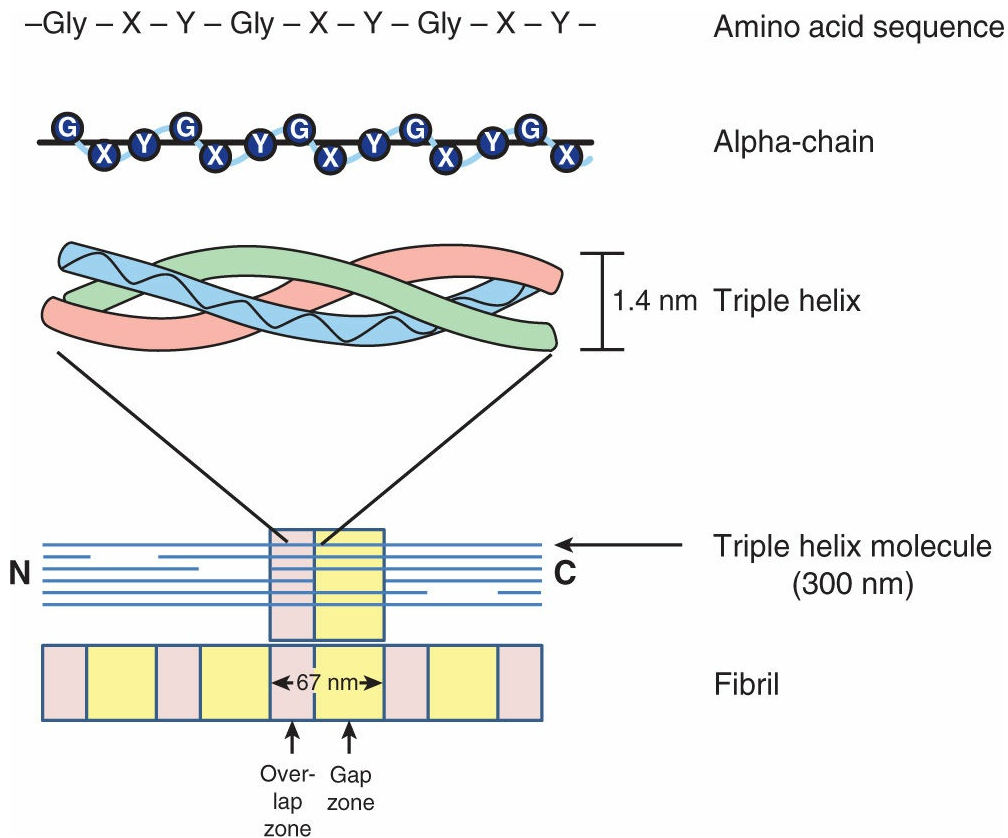

FIGURE 50–1 Molecular features of collagen structure from the primary sequence to the fibril. Each individual polypeptide chain is twisted into a left-handed helix of three residues (Gly-X-Y) per turn, and three of these chains are then wound into a right-handed superhelix. The triple helices are then assembled into a quarter-staggered alignment to form fibrils. This arrangement leads to areas where there is complete overlap of the molecules alternating with areas where there is a gap, giving the fibrils a regular banded appearance. (Modified and redrawn from Eyre DR: Collagen: molecular diversity in the body’s protein scaffold. *Science* 1980;207:1315. Reprinted with permission from AAAS.)

Some collagen types form long rod-like fibers in tissues. These are assembled by lateral association of these triple helical units into **fibrils** (10-300 nm in diameter) in a “**quarter-staggered**” alignment such that each is displaced longitudinally from its neighbor by slightly less than one-quarter of its length ([Figure 50–1](#)). Fibrils, in turn, associate into thicker **fibers** (1-20 μm in diameter). Because the quarter staggered alignment results in regularly spaced gaps between the triple helical molecules in the array, fibers have a banded appearance in connective tissues. In some tissues, for example tendons, fibers associate into even larger bundles, which may have a diameter of up to 500 μm . Collagen fibers are further

stabilized by the formation of **covalent cross-links**, both within and between the triple helical units. These cross-links form through the action of **lysyl oxidase**, a copper-dependent enzyme that oxidatively deaminates the ϵ -amino groups of certain lysine and hydroxylysine residues, yielding reactive aldehydes. Such aldehydes can form aldol condensation products with other lysine- or hydroxylysine-derived aldehydes or form Schiff bases with the ϵ -amino groups of unoxidized lysines or hydroxylysines. These reactions, after further chemical rearrangements, result in the stable covalent cross-links that are important for the tensile strength of the fibers. Histidine may also be involved in certain cross-links.

The main fibril-forming collagens in skin and bone and in cartilage, respectively, are types **I** and **II**, although other collagens also adopt this structure. In addition, however, there are many nonfibril-forming collagens and their structures and functions are described briefly in the section below.

Some Collagen Types Do Not Form Fibrils

Several collagen types do not form fibrils in tissues (**Figure 50–2**). They are characterized by interruptions of the triple helix with stretches of protein lacking Gly-X-Y repeat sequences. Thus, areas of globular structure are interspersed in the triple helical structure. **Network-like collagens** such as type IV form networks in basement membranes; **fibril-associated collagens with interrupted triple helices (FACITs)**, as their name indicates, have interruptions in the triple helical domains; **beaded filaments** consist of long chains of collagen molecules which have a regular beaded appearance; collagen VII forms the main part of **anchoring fibrils** in epithelial tissues; **transmembrane collagens** have short intracellular N-terminal domains and extracellular domains with long interrupted triple helices; **multiplexins** are collagens with multiple triple helix domains and interruptions.

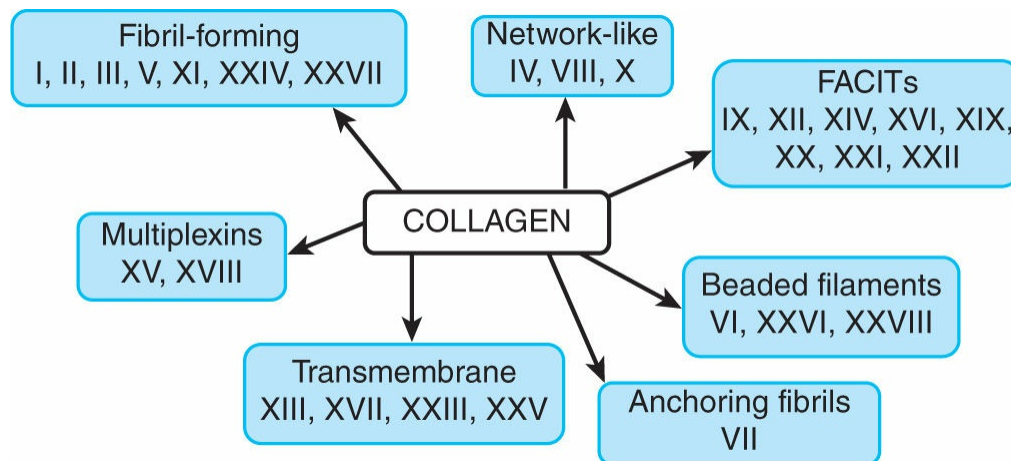

FIGURE 50–2 Classification of collagens according to the structures they form. FACIT, fibril-associated collagen with interrupted triple helices; multiplexin, multiple triple helix domains and interruptions.

Collagen Undergoes Extensive Posttranslational Modifications

Newly synthesized collagen undergoes extensive **posttranslational modification** before becoming part of a mature extracellular collagen fiber (**Table 50–2**). Like most secreted proteins, collagen is synthesized on ribosomes in a precursor form, **procollagen**, which contains a leader or signal sequence that directs the polypeptide chain into the lumen of the endoplasmic reticulum (ER) (see **Chapter 49**). As it enters the ER, this leader sequence is removed enzymatically. **Hydroxylation** of proline and lysine residues and **glycosylation** of hydroxylysines in the **procollagen** molecule also take place at this site. The procollagen molecule contains polypeptide extensions (**extension peptides**) of 20 to 35 kDa at both its amino- and carboxyl-terminal ends, which are not present in mature collagen. Both extension peptides contain cysteine residues. While the amino terminal propeptide forms only intrachain disulfide bonds, the carboxyl-terminal propeptides form both intrachain and interchain disulfide bonds. Formation of these disulfide bonds assists in the **registration** of the three collagen molecules to form the triple helix, winding from the carboxyl-terminal end. After formation of the triple helix, no further hydroxylation of proline or lysine or glycosylation of hydroxylysines can take place. **Self-assembly** is a cardinal principle in the biosynthesis of collagen.

TABLE 50–2 Order and Location of Processing of the Fibrillar

Collagen Precursor

Intracellular

1. Cleavage of signal peptide
2. Hydroxylation of prolyl residues and some lysyl residues; glycosylation of some hydroxylysyl residues
3. Formation of intrachain and interchain S–S bonds in extension peptides
4. Formation of triple helix

Extracellular

1. Cleavage of amino- and carboxyl-terminal propeptides
2. Assembly of collagen fibers in quarter-staggered alignment
3. Oxidative deamination of η -amino groups of lysyl and hydroxylysyl residues to aldehydes
4. Formation of intra- and interchain cross-links via Schiff bases and aldol condensation products

Following **secretion** from the cell by way of the Golgi apparatus, extracellular enzymes called **procollagen aminoproteinase** and **procollagen carboxyproteinase** remove the extension peptides at the amino- and carboxyl-terminal ends, respectively, forming the monomeric units of collagen, termed **tropocollagen**. Cleavage of the propeptides may occur within crypts or folds in the cell membrane. Once the propeptides are removed, the tropocollagen molecules, containing approximately 1000 amino acids per α chain, **spontaneously assemble** into collagen fibers. These are further stabilized by the formation of **inter- and intrachain cross-links** through the action of lysyl oxidase, as described previously.

The same cells that secrete collagen also secrete **fibronectin**, a large glycoprotein present on cell surfaces, in the extracellular matrix, and in blood (see below). Fibronectin binds collagen fibers during aggregation and alters the kinetics of fiber formation in the pericellular matrix. Associated with fibronectin and procollagen in this matrix are the **proteoglycans** heparan sulfate and chondroitin sulfate (see below). In fact, **type IX collagen**, a minor collagen type from cartilage, contains an attached glycosaminoglycan chain. Such interactions may serve to regulate the formation of collagen fibers and to determine their orientation in tissues.

Once formed, collagen is relatively **metabolically stable**. However, its breakdown is increased during starvation and various inflammatory states. Excessive production of collagen occurs in a number of conditions, for example, hepatic cirrhosis.

A Number of Genetic & Deficiency Diseases Result From Abnormalities in the Synthesis of Collagen

More than 30 genes encode the collagens, and they are designated according to the procollagen type and their constituent α chains, called pro α chains. Collagens may be homotrimeric, containing three identical pro α chains, or heterotrimeric, where the pro α chains are different. For example, type I collagen is heterotrimeric, containing two pro α 1(I) and one pro α 2(I) chains (the arabic number refers to the pro α chain, and the roman numeral in parentheses indicates the collagen type), while type II collagen is homotrimeric, having three pro α 1(II) chains. Collagen genes have the prefix *COL* followed by the type in arabic numerals, then an A and the number of the pro α chain they encode. Thus, *COL1A1* and *COL1A2* are the genes for the pro α 1 and 2 chains of type I collagen, *COL2A1* is the gene for the pro α 1 chain of type II collagen, and so on.

The pathway of collagen biosynthesis is complex, involving at least eight enzyme-catalyzed posttranslational steps. Thus, it is not surprising that a number of diseases (**Table 50–3**) are due to **mutations in collagen genes** or in **genes encoding some of the enzymes** involved in these posttranslational modifications. Diseases affecting bone (eg, osteogenesis imperfecta) and cartilage (eg, the chondrodysplasias) will be discussed later in this chapter.

TABLE 50–3 Diseases Caused by Mutations in Collagen Genes or by Deficiencies in the Activities of Enzymes Involved in the Posttranslational Biosynthesis of Collagen

Gene or Enzyme Affected	Disease ^a
<i>COL1A1, COL1A2</i>	Osteogenesis imperfecta type 1 ^b Osteoporosis Ehlers-Danlos syndrome, subtype arthrochalasia
<i>COL2A1</i>	Severe chondrodysplasia Osteoarthritis
<i>COL3A1</i>	Ehlers-Danlos syndrome, subtype vascular
<i>COL4A3-COL4A6</i>	Alport syndrome (autosomal and X-linked)
<i>COL7A1</i>	Epidermolysis bullosa, dystrophic
<i>COL10A1</i>	Schmid metaphyseal chondrodysplasia
<i>COL5A1, COL5A2, COL1A1</i>	Ehlers-Danlos syndrome, subtype classical
<i>COL3A1, tenascin XB (TNXB)</i>	Ehlers-Danlos syndrome, subtype hypermobility
Lysyl hydroxylase	Ehlers-Danlos syndrome, subtype kyphoscoliosis
ADAM metalloproteinase with thrombospondin type 1 motif (<i>ADAMTS2</i>) (also called procollagen <i>N</i> -proteinase)	Ehlers-Danlos syndrome, subtype dermatosparaxis
Lysyl oxidase	Menkes disease ^c

Ehlers-Danlos syndrome (formerly called Cutis hyperelastica), comprises a group of inherited disorders whose principal clinical features are hyperextensibility of the skin, abnormal tissue fragility, and increased joint mobility. The clinical picture is variable, reflecting underlying extensive genetic heterogeneity. A number of forms of the disease caused by genetic defects in proteins involved in the synthesis and assembly of collagens type I, III, and V are known, and since 1997 the Villefranche classification of six subtypes based on their phenotype and molecular defects has been used (**Table 50–4**). The **hypermobility, vascular and classical** subtypes are more common, while the other three,

kyphoscoliosis, arthrochhalasis, and dermatosparaxis are extremely rare. The vascular subtype is the most serious because of its tendency for spontaneous rupture of arteries or the bowel, reflecting abnormalities in type III collagen. Patients with kyphoscoliosis exhibit progressive curvature of the spine (scoliosis) and a tendency to ocular rupture due to a deficiency of lysyl hydroxylase. A deficiency of procollagen *N*-proteinase (ADAM metalloproteinase with thrombospondin type 1 motif [ADAMTS2]), causing formation of abnormal thin, irregular collagen fibrils, results in dermatosparaxis, manifested by marked fragile and sagging skin.

TABLE 50–4 The Villefranche Classification^a of Ehlers-Danlos Syndrome Subtypes

Subtype Name	Defect in	Incidence	Clinical Signs
Hypermobility	Type III collagen, tenascin X ^b	1:10,000-15,000	Joint hypermobility, skin abnormalities, osteoarthritis, severe pain
Classical	Types I and V collagen	1:20,000-30,000	Similar to the hypermobility subtype, but with more severe skin abnormalities and less severe joint changes
Vascular	Type III collagen	1:100,000	Fragile blood vessels and organs, small stature, thin and translucent skin, easy bruising
Kyphoscoliosis	Lysyl hydroxylase	<60 cases	Curvature of the spine (scoliosis), severe muscle weakness, fragile eyes, hyperextensible and bruisable skin
Arthrochhalasis	Type I collagen	<40 cases	Very loose joints and dislocation of both hips
Dermatosparaxis	ADAM metalloproteinase with thrombospondin type 1 motif (ADAMTS2) ^c	<10 cases	Very fragile and sagging skin

The **Alport syndrome** (hereditary nephritis) is the name given to a number of genetic disorders (both X-linked and autosomal) affecting **type IV** collagen, a network-like collagen which forms part of the structure of the basement membranes of the renal glomeruli, inner ear, and eye (see discussion of laminin, below). Mutations in several genes encoding type IV collagen fibers have been demonstrated. The main presenting sign is hematuria, accompanied by ocular lesions and hearing loss, and patients may eventually develop end-stage renal disease. Electron microscopy reveals characteristic abnormalities of the structure of the basement membrane and lamina densa.

In **epidermolysis bullosa**, the skin breaks and blisters as a result of minor trauma. The dystrophic form of the disease is due to mutations in

COL7A1, which affect the structure of **type VII** collagen. This collagen forms delicate fibrils that anchor the basal lamina to collagen fibrils in the dermis. These anchoring fibrils have been shown to be markedly reduced in dystrophic epidermolysis bullosa, probably resulting in the blistering. Epidermolysis bullosa simplex, another variant, is due to mutations in keratin 5 (see [Chapter 51](#)).

Although **Scurvy** affects the structure of collagen, it is caused by a **dietary deficiency of ascorbic acid** (vitamin C) (see [Chapter 44](#)), not a genetic abnormality. Its major signs are bleeding gums, subcutaneous hemorrhages, and poor wound healing. These signs reflect defective synthesis of collagen due to reduced activity of the enzymes **prolyl and lysyl hydroxylases**, both of which require ascorbic acid as a cofactor and are involved in posttranslational modifications which give collagen molecules rigidity.

In **Menkes disease**, deficiency of copper results in defective cross-linking of collagen and elastin by the copper-dependent enzyme lysyl oxidase. (Menkes disease is discussed in [Chapter 52](#).)

ELASTIN CONFERS EXTENSIBILITY & RECOIL ON LUNG, BLOOD VESSELS, & LIGAMENTS

Elastin is a connective tissue protein that is responsible for properties of extensibility and elastic recoil in tissues. Although not as widespread as collagen, elastin is present in large amounts in tissues that require these physical properties, for example, lung, large arterial blood vessels, and some elastic ligaments. Smaller quantities of elastin are also found in skin, ear cartilage, and several other tissues. In contrast to collagen, only one genetic type of elastin is known, although variants arise by alternative splicing (see [Chapter 36](#)) of the hnRNA for elastin. Elastin is synthesized as a soluble monomer of ~70 kDa called **tropoelastin**. Some of the prolines of tropoelastin are hydroxylated to **hydroxyproline** by prolyl hydroxylase, though hydroxylysine and glycosylated hydroxylysine are not present. Unlike collagen, tropoelastin is not synthesized in a proform with extension peptides. Furthermore, elastin does not contain repeat Gly-X-Y sequences, triple helical structure, or carbohydrate moieties.

After secretion from the cell, certain lysyl residues of tropoelastin are oxidatively deaminated to aldehydes by **lysyl oxidase**, the same enzyme involved in this process in collagen. However, the major cross-links formed in elastin are the **desmosines**, which result from the condensation of three of these lysine-derived aldehydes with an unmodified lysine to

form a tetrafunctional cross-link unique to elastin. Once cross-linked in its mature, extracellular form, elastin is highly insoluble, **extremely stable**, and has a very low-turnover rate. The various random coil conformations present in its structure permit the protein to stretch and subsequently recoil during the performance of its physiologic functions.

Table 50–5 summarizes the main differences between collagen and elastin.

TABLE 50–5 Major Differences Between Collagen and Elastin

Collagen	Elastin
1. Many different genetic types	One genetic type
2. Triple helix	No triple helix; random coil conformations permitting stretching
3. (Gly-X-Y) _n repeating structure	No (Gly-X-Y) _n repeating structure
4. Presence of hydroxylysine	No hydroxylysine
5. Carbohydrate-containing	No carbohydrate
6. Intramolecular aldol cross-links	Intramolecular desmosine cross-links
7. Presence of extension peptides during biosynthesis	No extension peptides present during biosynthesis

Deletions in the elastin gene (located at 7q11.23) have been found in approximately 90% of subjects with the **Williams-Beuren syndrome**, a developmental disorder affecting connective tissue and the central nervous system. The mutations, affect the synthesis of elastin, and probably play a causative role in the **supravalvular aortic stenosis** often found in this condition. Fragmentation or, alternatively, a decrease of elastin is found in conditions such as **pulmonary emphysema, cutis laxa, and aging of the skin**.

FIBRILLINS ARE STRUCTURAL COMPONENTS OF MICROFIBRILS

Microfibrils are fine fiber-like strands 10 to 12 nm in diameter which provide a **scaffold** for the deposition of elastin in the ECM. **Fibrillins** are large glycoproteins (about 350 kDa) that are major structural component of

these fibers. They are secreted (subsequent to a proteolytic cleavage) into the ECM by fibroblasts and become incorporated into the insoluble microfibrils. **Fibrillin-1** is the main fibrillin present, but fibrillins-2 and 3 have also been identified, and fibrillin-2 is thought to be important in deposition of microfibrils early in development. Other proteins including **microfibril-associated glycoproteins (MAGPs)**, **fibulins**, and **members of the ADAMTS family** are also associated with microfibrils. Fibrillin microfibrils are found in elastic fibers and also in elastin-free bundles in the eye, kidney, and tendons.

Marfan Syndrome Is Caused by Mutations in the Gene for Fibrillin-1

Marfan syndrome is a relatively prevalent inherited disease affecting connective tissue; it is inherited as an autosomal dominant trait. It affects the **eyes** (eg, causing dislocation of the lens, known as ectopia lentis), the **skeletal system** (most patients are tall and exhibit long digits [arachnodactyly] and hyperextensibility of the joints), and the **cardiovascular system** (eg, causing weakness of the aortic media, leading to dilation of the ascending aorta). Abraham Lincoln may have had this condition. Most cases are caused by mutations in the gene (on chromosome 15) for fibrillin-1. This results in abnormal fibrillin and/or lower amounts being deposited in the ECM. Since the cytokine transforming growth factor β (**TGF- β**) normally binds to fibrillin-1, decreased binding in Marfan syndrome causes disturbances in TGF- β signaling. This could potentially lead to the development of therapies for the condition using drugs that antagonize TGF- β (eg, the angiotensin II receptor antagonist, Losartan).

Mutations in the fibrillin-1 gene have also been identified as the cause of **acromicric dysplasia** and **geleophysic dysplasia**, which are characterized by short stature, skin thickening, and stiff joints. **Congenital contractural arachnodactyly** is associated with a mutation in the gene for fibrillin-2. The probable sequence of events leading to Marfan syndrome is summarized in **Figure 50–3**.

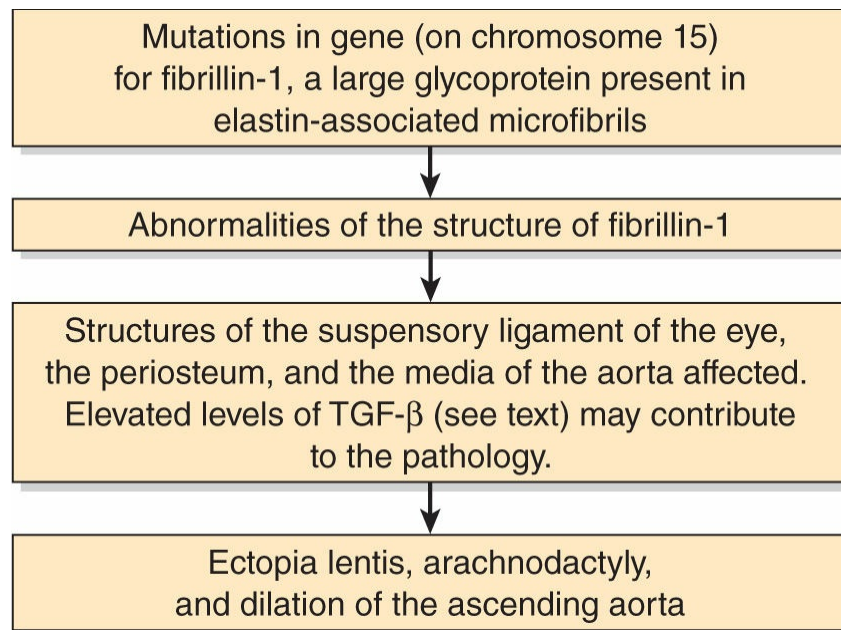

FIGURE 50–3 Probable sequence of events in the causation of the major signs exhibited by patients with Marfan syndrome.

FIBRONECTIN IS INVOLVED IN CELL ADHESION & MIGRATION

Fibronectin is a major glycoprotein of the extracellular matrix, also found in a soluble form in plasma. It consists of two identical subunits, each of about 230 kDa, joined by two disulfide bridges near their carboxyl terminals. The gene encoding fibronectin is very large, containing some 50 exons; the RNA produced by its transcription is subject to considerable alternative splicing, and as many as 20 different mRNAs have been detected in various tissues. Fibronectin contains three types of repeating motifs (I, II, and III), which are organized into functional **domains** (at least seven); functions of these domains include binding fibronectin (enabling molecules of the protein to interact) **heparin** (see below), fibrin, collagen, and cell surfaces (**Figure 50–4**). Fibronectin binds to cells via a transmembrane receptor protein which belongs to the **integrin** class of proteins (see **Chapter 55**). Fibronectin contains an **Arg-Gly-Asp (RGD) sequence** that binds to the integrin receptor. This sequence is shared by a number of other proteins present in the ECM that bind to integrins present in cell plasma membranes, and its presence in synthetic peptides enables them to inhibit the binding of fibronectin to cells. **Figure 50–5** illustrates the interaction of collagen, fibronectin, and laminin, all major proteins of the ECM, with a typical cell (eg, fibroblast) present in the matrix.

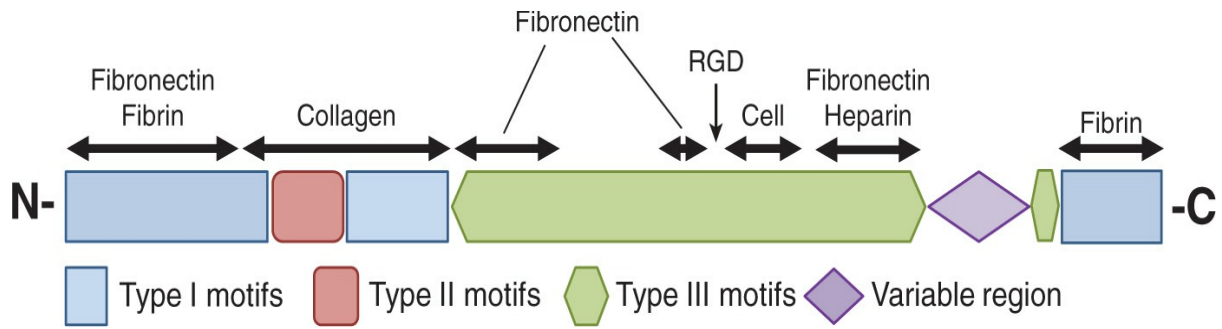

FIGURE 50–4 Structure of the fibronectin monomer. Fibronectin is a dimer joined by disulfide bridges (not shown) near the carboxyl terminals of the monomers. Each monomer consists mainly of repeating motifs of type I, II, or III and has a number of protein-binding domains. Four bind fibronectin and there are also domains for collagen, heparin, fibrin, and cell binding. The approximate location of the RGD sequence of fibronectin, which interacts with a variety of fibronectin integrin receptors on cell surfaces, is indicated by the arrow.

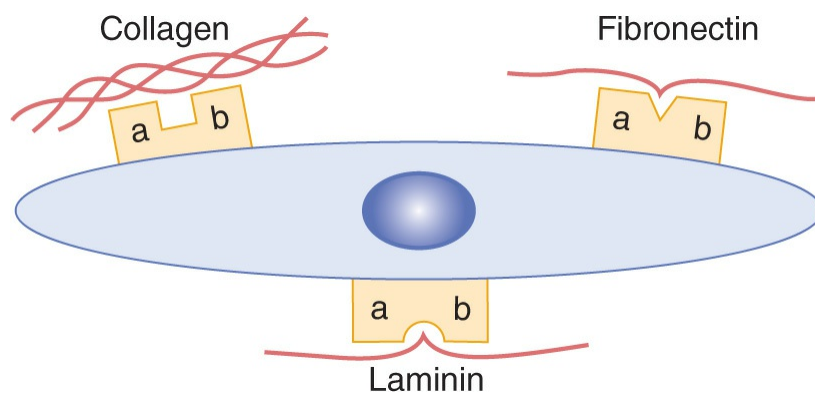

FIGURE 50–5 Schematic representation of a cell interactions with major proteins of the ECM. a and b indicate α - and β -polypeptide chains of integrins.

The fibronectin receptor interacts indirectly with **actin** microfilaments (see [Chapter 51](#)) present in the cytosol via a number of proteins, collectively known as **attachment proteins**; these include **talin**, **vinculin**, **α -actinin**, and **paxillin** ([Figure 50–6](#)). Such large protein complexes form **focal adhesions** which not only anchor cells in the ECM, but also relay signals from the exterior which influence cell behavior. Thus, the interaction of fibronectin with its receptor provides one route whereby the **outside of the cell can communicate with the inside**. Fibronectin is also involved in **cell migration**, as it provides a binding site for cells and thus helps them to steer their way through the ECM. The amount of fibronectin

around many **transformed cells** is sharply reduced, partly explaining their faulty interaction with the ECM.

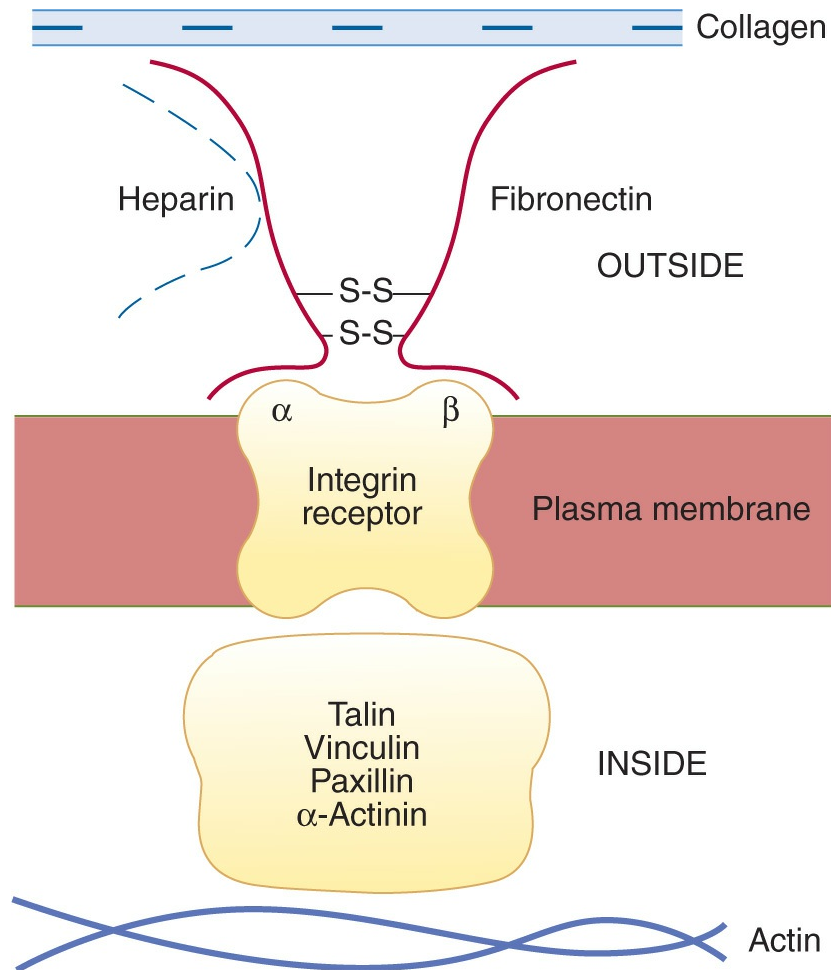

FIGURE 50–6 Schematic representation of fibronectin interacting with actin in the cytosol via an integrin fibronectin receptor. The fibronectin dimer on the outside of the plasma membrane binds to the membrane-spanning integrin receptor via the RGD sequences. On the cytosolic side, integrin interacts with attachment proteins including talin, vinculin, α -actinin, and paxillin (shown as a complex) which interact with actin microfilaments, thus indirectly linking fibronectin in the ECM with actin in the cell cytosol.

LAMININ IS A MAJOR PROTEIN COMPONENT OF BASAL LAMINAS

Basal laminas are specialized areas of the ECM that surround epithelial and some other cells (eg, muscle cells). **Laminin** (a glycoprotein of about 850 kDa and 70-nm length) consists of three distinct elongated polypeptide

chains (α , β , and γ chains, each of which have genetic variants) linked together to form a complex, elongated shape (see [Figure 51–11](#), which shows **laminin-2, also called merosin**). In basal laminae, laminin forms networks which are attached to type IV collagen by **entactin** (also called nidogen), a glycoprotein containing an RGD sequence, and the heparan sulfate proteoglycan, **perlecan**. The collagen interacts with laminin (rather than directly with the cell surface), which in turn interacts with integrins or other proteins, such as **dystroglycans** (see [Chapter 51](#)) thus anchoring the lamina to the cells ([Figure 50–7](#)).

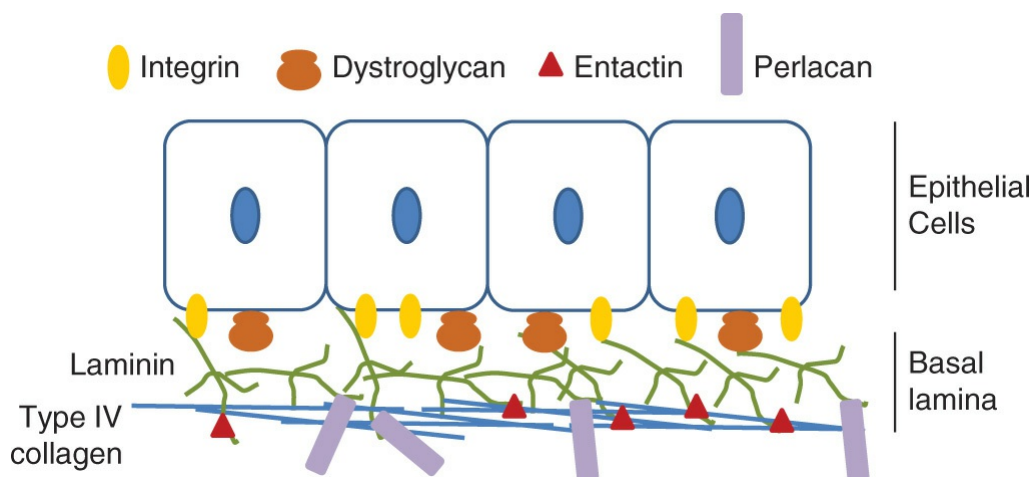

FIGURE 50–7 Structure of the basal lamina. Laminin is attached to type IV collagen via entactin and perlecan (forming the basal lamina) and to the epithelial cell layer via integrins and dystroglycans.

In the **renal glomerulus**, the basal lamina consists of two separate sheets of cells (one endothelial and one epithelial), each disposed on opposite sides of the lamina; these three layers make up the **glomerular membrane**. This relatively thick basal lamina has an important role in **glomerular filtration**. The glomerular membrane allows small molecules, such as **inulin** (5.2 kDa), to pass through as easily as water. On the other hand, large molecules, including most plasma proteins, are not able to pass through. The reason for this is two-fold: (1) The **pores** in the glomerular membrane are about 8-nm across, thus molecules larger than this are unable to pass through. (2) Although some plasma proteins, such as albumin, are smaller than this pore size, they are prevented from passing through easily by the **negative charges** of heparan sulfate and of certain sialic acid-containing glycoproteins present in the lamina which repel most plasma proteins, which are negatively charged at the pH of blood. The normal structure of the glomerulus may be severely damaged in certain types of

glomerulonephritis (eg, caused by antibodies directed against various components of the glomerular membrane). This affects the pores and the amounts and dispositions of the negatively charged macromolecules referred to above, and relatively massive amounts of albumin (and of certain other plasma proteins) can pass through into the urine, resulting in severe **albuminuria**.

PROTEOGLYCANS & GLYCOSAMINOGLYCANS

The Glycosaminoglycans Found in Proteoglycans Are Built Up of Repeating Disaccharides

Proteoglycans, proteins that contain covalently linked **glycosaminoglycans** (GAGs) (see also [Chapters 15](#) and [46](#)), are a major component of the ECM. At least 30 have been characterized, for example, syndecan, betaglycan, serglycin, perlecan, aggrecan, versican, decorin, biglycan, and fibromodulin. A proteoglycan consists of a **core protein** bound covalently to GAGs, and these units form large complexes with other components of the extracellular matrix, such as hyaluronic acid or collagen. [Figures 50–8](#) and [50–9](#) show the general structure of such complexes. They are very large with an overall structure resembling that of a bottlebrush. The example shown in [Figure 50–9](#) contains a long strand of hyaluronic acid (one type of GAG) (see [Chapter 15](#)) to which link proteins are attached **noncovalently**. In turn, the link proteins interact noncovalently with core protein molecules from which chains of other GAGs (eg, keratan sulfate and chondroitin sulfate) project. Proteoglycans vary in tissue distribution, nature of the core protein, attached GAGs, and their function. The amount of **carbohydrate** in a proteoglycan is usually much greater than that found in a glycoprotein, and may comprise up to 95% of its weight.

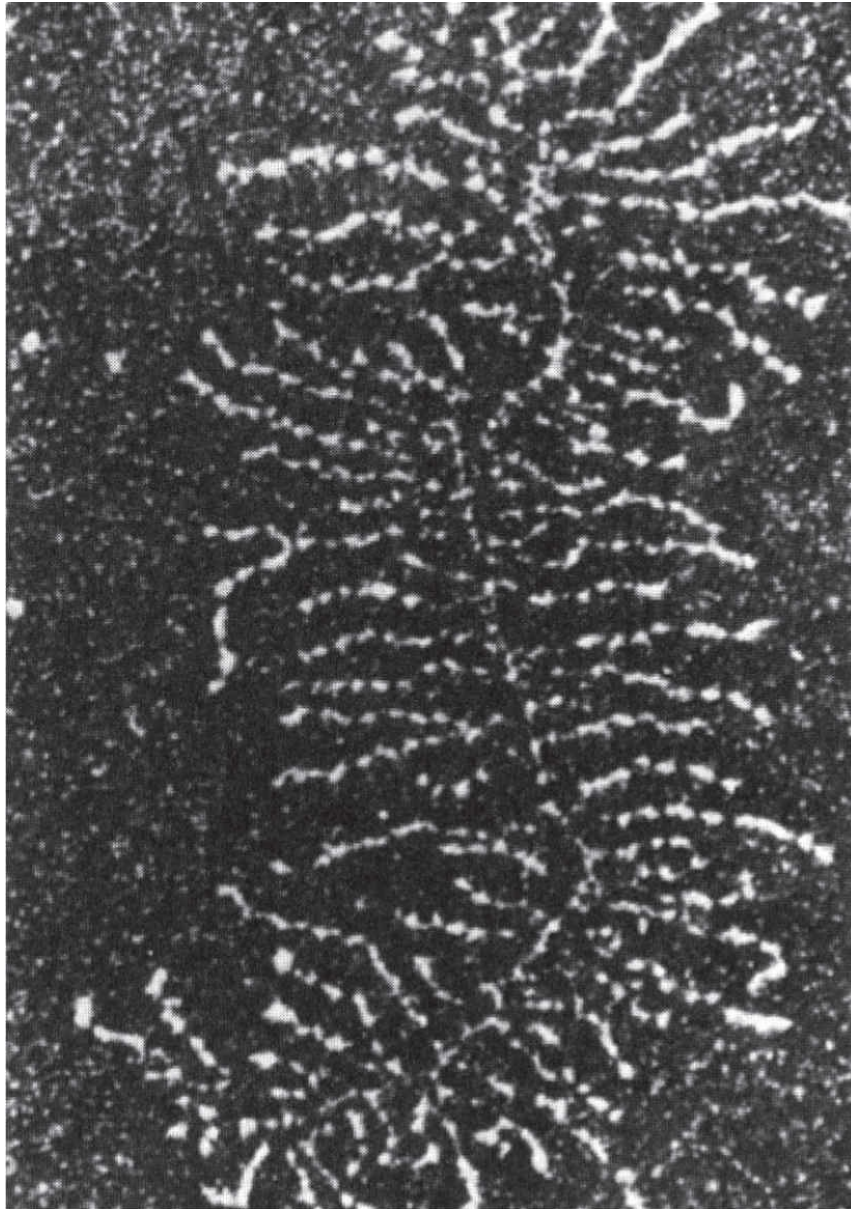

FIGURE 50–8 Darkfield electron micrograph of a proteoglycan aggregate. The proteoglycan subunits and filamentous backbone are particularly well extended in this image. (Reproduced, with permission, from Rosenberg L, Hellman W, Kleinschmidt AK: Electron microscopic studies of proteoglycan aggregates from bovine articular cartilage. *J Biol Chem* 1975;250:1877.)

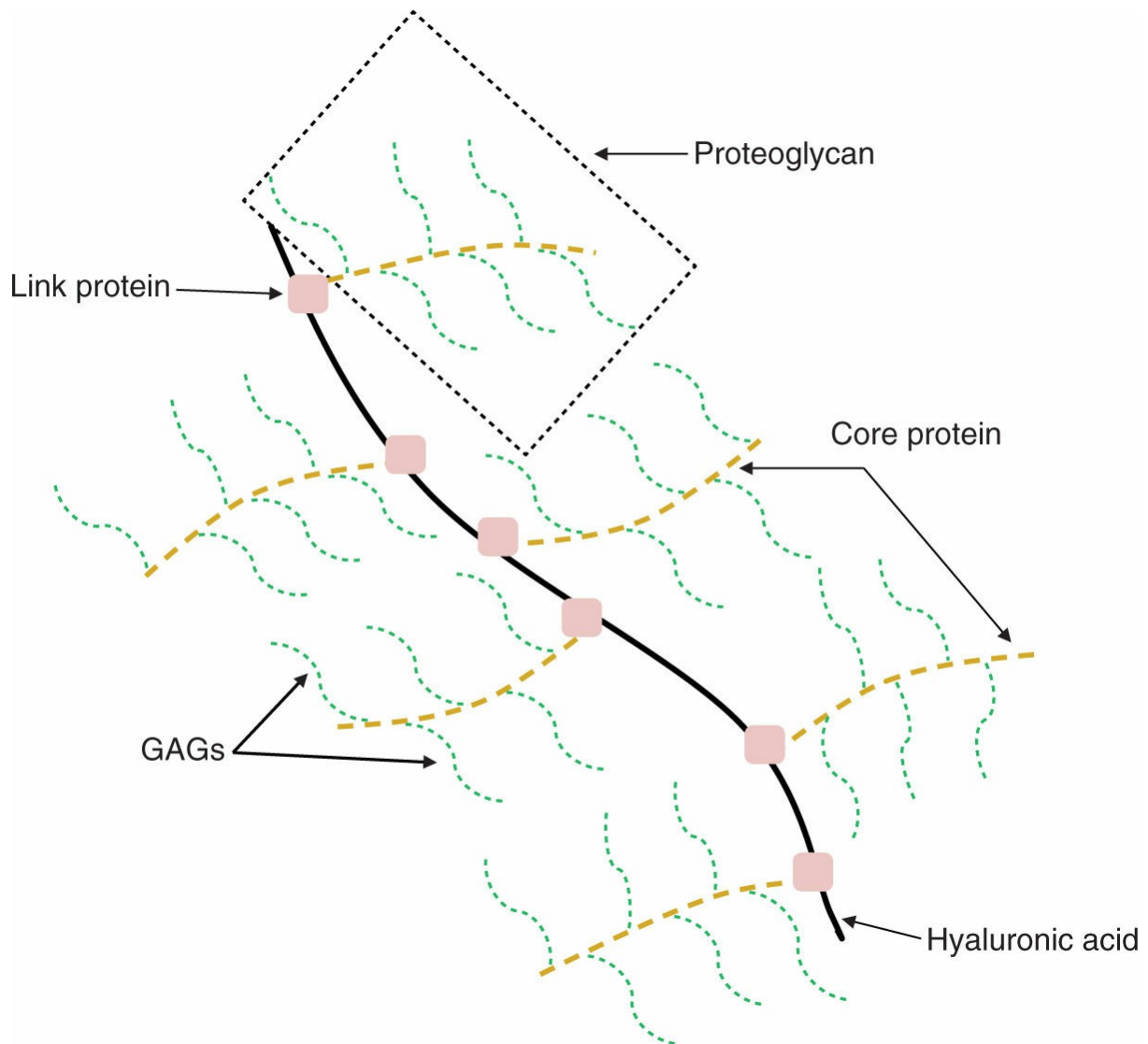

FIGURE 50–9 Schematic representation of a proteoglycan complex.

In this example, proteoglycans are attached via noncovalent bonds to link proteins which, in turn, bond noncovalently to a long strand of the glycoaminoglycan (GAG), hyaluronic acid.

There are at least seven GAGs: **hyaluronic acid (hyaluronan), chondroitin sulfate, keratan sulfates I and II, heparin, heparan sulfate, and dermatan sulfate.** GAGs are unbranched polysaccharides made up of repeating disaccharides, one component of which is always an **amino sugar** (hence, the name GAG), either D-glucosamine or D-galactosamine. The other component of the repeating disaccharide (except in the case of keratan sulfate) is a **uronic acid**, either D-glucuronic acid (GlcUA) or its 5'-epimer, L-iduronic acid (IdUA). With the exception of hyaluronic acid, all the GAGs contain **sulfate groups**, either as *O*-esters or as *N*-sulfate (in heparin and heparan sulfate). Hyaluronic acid is also

exceptional because it appears to exist as a polysaccharide in the ECM, with no covalent attachment to protein, as the definition of a proteoglycan given above specifies. Both GAGs and proteoglycans have proved difficult to work with, partly because of their complexity. However, since they are major components of the ECM and have a number of important biologic roles as well as being involved in a number of disease processes, interest in them has increased greatly in recent years.

Biosynthesis of Glycosaminoglycans Involves Attachment to Core Proteins, Chain Elongation, & Chain Termination

Attachment to Core Proteins

The linkage between GAGs and their core proteins is generally one of the following three types:

1. An **O-glycosidic bond** between **xylose (Xyl)** and **Ser**, a bond that is unique to proteoglycans. This linkage is formed by transfer of a Xyl residue to Ser from UDP-xylose. Two residues of Gal are then added to the Xyl residue, forming a **link trisaccharide**, Gal-Gal-Xyl-Ser. Further chain growth of the GAG occurs on the terminal Gal.
2. An **O-glycosidic bond** between **GalNAc** (*N*-acetylgalactosamine) and **Ser (Thr)** (see [Figure 46–1A](#)), present in keratan sulfate II. This bond is formed by donation to Ser (or Thr) of a GalNAc residue, employing UDP-GalNAc as its donor.
3. An **N-glycosylamine bond** between **GlcNAc** (*N*-acetylglucosamine) and the amide nitrogen of **Asn**, as found in *N*-linked glycoproteins (see [Figure 46–1B](#)). Its synthesis is believed to involve dolichol-PP oligosaccharide.

The synthesis of the core proteins occurs in the **ER**, and formation of at least some of the above linkages also occurs there. Most of the later steps in the biosynthesis of GAG chains and their subsequent modifications occur in the **Golgi apparatus**.

Chain Elongation

Appropriate **nucleotide sugars** and highly specific Golgi-located **glycosyltransferases** are employed to synthesize the oligosaccharide chains of GAGs. The “**one enzyme, one linkage**” relationship appears to

hold here, as in the case of certain types of linkages found in glycoproteins. The enzyme systems involved in chain elongation are capable of high-fidelity reproduction of complex GAGs (see also [Chapter 46](#)).

Chain Termination

This appears to result from (1) **sulfation**, particularly at certain positions of the sugars, and (2) the **progression** of the growing GAG chain away from the membrane site where catalysis occurs.

Further Modifications

After formation of the GAG chain, **numerous chemical modifications** occur, such as the introduction of sulfate groups onto GalNAc and other moieties and the epimerization of GlcUA to IdUA residues. The enzymes catalyzing sulfation are designated **sulfotransferases** and use **3'-phosphoadenosine-5'-phosphosulfate** [PAPS; active sulfate] (see [Chapter 32](#)) as the sulfate donor. These Golgi-located enzymes are highly specific, and distinct enzymes catalyze sulfation at different positions (eg, carbons 2, 3, 4, and 6) on the acceptor sugars. An **epimerase** catalyzes conversions of glucuronyl to iduronyl residues.

Proteoglycans Are Important in the Structural Organization of the Extracellular Matrix

Proteoglycans are found in **every tissue** of the body, mainly in the ECM or “ground substance.” There they are associated with each other and also with the other major structural components of the matrix, collagen, and elastin, in specific ways. Some proteoglycans bind to collagen and others to elastin. These interactions are important in determining the structural organization of the matrix. Some proteoglycans (eg, decorin) can also **bind growth factors** such as TGF- β , modulating their effects on cells. In addition, some of them interact with certain **adhesive proteins** such as fibronectin and laminin (see above), also found in the matrix. The GAGs present in the proteoglycans are **polyanions** and hence bind polycations and cations such as Na^+ and K^+ . This latter ability attracts water by osmotic pressure into the extracellular matrix and contributes to its turgor. GAGs also **gel** at relatively low concentrations. Because of the long, extended nature of the polysaccharide chains of GAGs and their ability to gel, the proteoglycans can act as **sieves**, restricting the passage of large

macromolecules into the ECM but allowing relatively free diffusion of small molecules. Again, because of their extended structures and the huge macromolecular aggregates they often form, they occupy a **large volume** of the matrix relative to proteins.

Various Glycosaminoglycans Exhibit Differences in Structure & Have Characteristic Distributions and Diverse Functions

The seven GAGs named above differ from each other in a number of the following properties: amino sugar composition, uronic acid composition, linkages between these components, chain length of the disaccharides, the presence or absence of sulfate groups and their positions of attachment to the constituent sugars, the nature of the core proteins to which they are attached, the nature of the linkage to core protein, their tissue and subcellular distribution, and their biologic functions.

The structure (**Figure 50–10**), distribution, and functions of each of the GAGs will now be briefly discussed. The major features of the seven GAGs are summarized in **Table 50–6**.

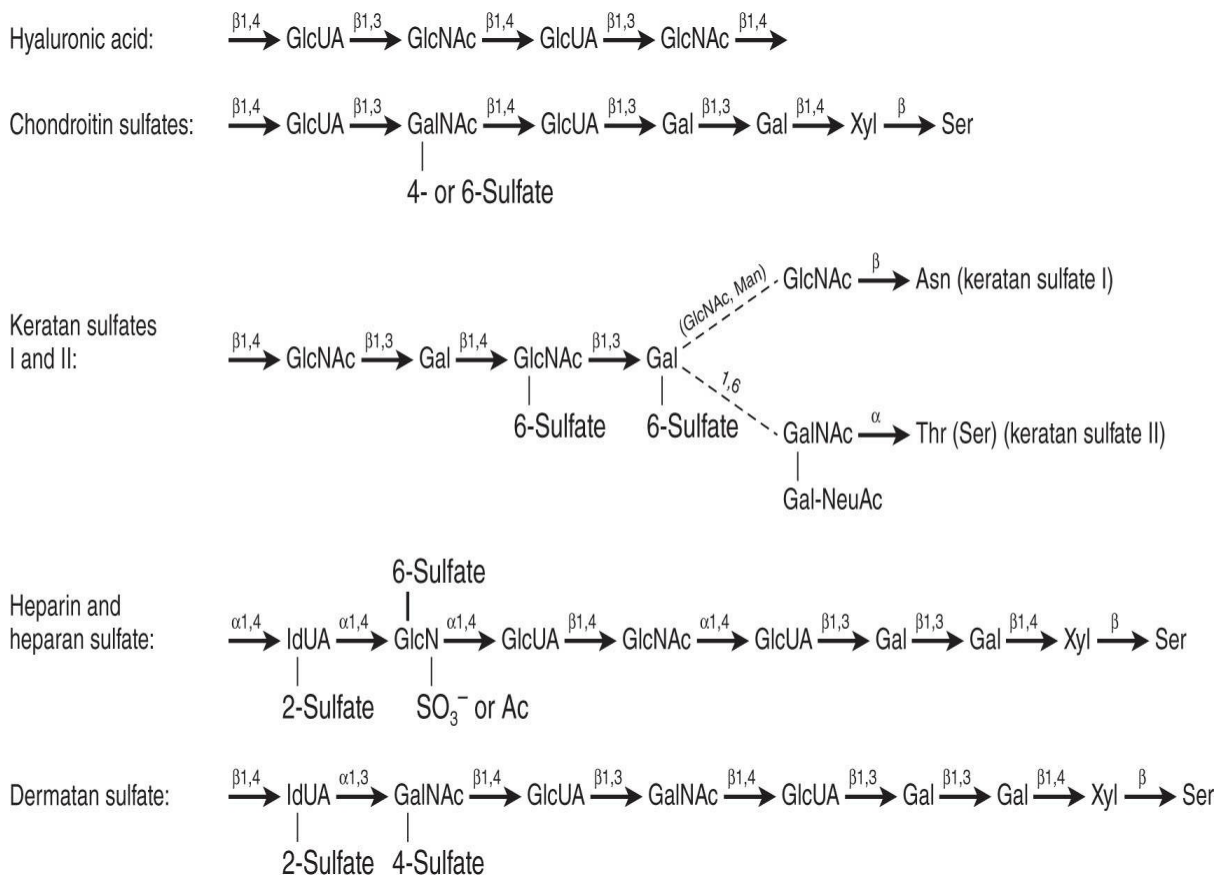

FIGURE 50–10 Structures of glycosaminoglycans and their attachments to core proteins. (Ac, acetyl; Asn, L-asparagine; Gal, D-galactose; GalN, D-galactosamine; GlcN, D-glucosamine; GlcUA, D-glucuronic acid; IdUA, L-iduronic acid; Man, D-mannose; NeuAc, *N*-acetylneuraminic acid; Ser, L-serine; Thr, L-threonine; Xyl, L-xylose.) The summary structures are qualitative representations only and do not reflect, for example, the uronic acid composition of hybrid glycosaminoglycans such as heparin and dermatan sulfate, which contain both L-iduronic and D-glucuronic acid. Hyaluronic acid has no covalent attachment to protein. Chondroitin sulfates, heparin, heparan sulfate, and dermatan sulfate attach to a Ser on the core protein via the Gal-Gal-Xyl link trisaccharide. Keratan sulfate I links to a core protein Asn via GlcNAc and Keratan sulfate II to a Ser (or Thr) via GalNAc.

TABLE 50–6 Properties of Glycosaminoglycans

GAG	Sugars	Sulfate ^a	Protein Linkage	Location
Hyaluronic acid	GlcNAc, GlcUA	–	None	Skin, synovial fluid, bone, cartilage, vitreous humor, embryonic tissues
Chondroitin sulfate	GalNAc, GlcUA	GalNAc	Xyl-Ser; associated with HA via link proteins	Cartilage, bone, CNS
Keratan sulfate I and II	GlcNAc, Gal	GlcNAc	GlcNAc-Asn (KS I) GalNAc-Thr (KS II)	Cornea, cartilage, loose connective tissue
Heparin	Gln, IdUA	GlcN GlcN IdUA	Ser	Mast cells, liver, lung, skin
Heparan sulfate	GlcN, GlcUA	GlcN	Xyl-Ser	Skin, kidney basement membrane
Dermatan sulfate	GalNAc, IdUA, (GlcUA)	GalNAc IdUA	Xyl-Ser	Skin, wide distribution

Hyaluronic Acid

Hyaluronic acid consists of an unbranched chain of repeating disaccharide units containing GlcUA and GlcNAc. It is present in bacteria and is found in the ECM of nearly all animal tissues, but is especially high in concentration in highly hydrated types such as skin and umbilical cord, and in bone, cartilage, joints (synovial fluid) and in vitreous humor in the eye, as well as in embryonic tissues. It is thought to play an important role in permitting **cell migration** during morphogenesis and wound repair. Its ability to attract water into the ECM triggers loosening of the matrix,

aiding this process. The high concentrations of hyaluronic acid together with chondroitin sulfates present in **cartilage** contribute to its compressibility (see below).

Chondroitin Sulfates (Chondroitin 4-Sulfate & Chondroitin 6-Sulfate)

Proteoglycans linked to **chondroitin sulfate** by the Xyl-Ser O-glycosidic bond are prominent components of **cartilage** (see below). The repeating disaccharide is similar to that found in hyaluronic acid, containing GlcUA but with **GalNAc** replacing GlcNAc. The GalNAc is substituted with **sulfate** at either its 4' or its 6' position, with approximately one sulfate being present per disaccharide unit. Chondroitin sulfates have an important role in maintaining the structure of the ECM. They are located at sites of calcification in endochondral **bone** and are a major component of **cartilage**. They are found in high amounts in the ECM of the central nervous system and, in addition to their structural function, are thought to act as signaling molecules in the prevention of the repair of nerve endings after injury.

Keratan Sulfates I & II

As shown in [Figure 50–10](#), the keratan sulfates consist of repeating **Gal-GlcNAc** disaccharide units containing **sulfate** attached to the 6' position of GlcNAc or occasionally of Gal. **Keratan sulfate I** was originally isolated from the **cornea**, while **keratan sulfate II** came from cartilage. The two GAGs differ in the structural links to the core proteins, and as I or II, the classification is based on the different linkage to the core protein ([Figure 50–10](#)). In the eye, they lie between collagen fibrils and play a critical role in corneal transparency. Changes in proteoglycan composition found in corneal scars disappear when the cornea heals.

Heparin

The repeating disaccharide **heparin** contains **glucosamine** (GlcN) and either of the two uronic acids (GlcUA or IdUA) ([Figure 50–11](#)). Most of the amino groups of the GlcN residues are **N-sulfated**, but a few are acetylated (GlcNAc). The GlcN also carries a sulfate attached to carbon 6.

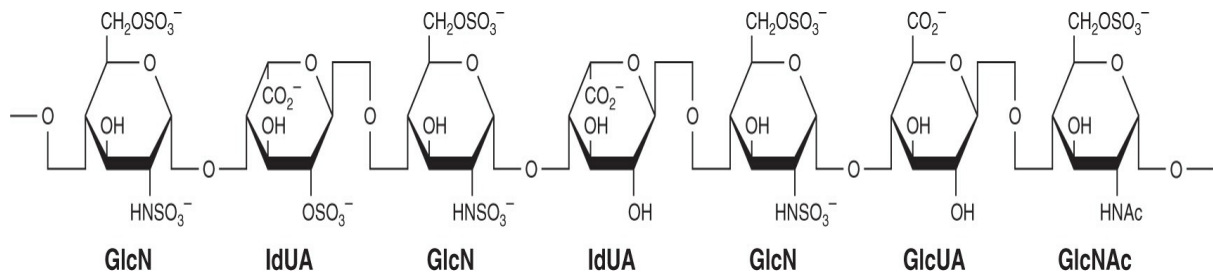

FIGURE 50–11 Structure of heparin. Structural features typical of heparin are shown. Each repeating disaccharide contains glucosamine (GlcN) and either D-glucuronic (GlcUA) or L-iduronic acid (IdUA). A few GlcN residues are acetylated (GlcNAc). The sequence of variously substituted repeating disaccharide units has been arbitrarily selected. Non-*O*-sulfated or 3-*O*-sulfated glucosamine residues may also occur. (Modified and redrawn from Lindahl U, et al: Structure and biosynthesis of heparin-like polysaccharides. *Fed Proc* 1977;36:19.)

The vast majority of the uronic acid residues are **IdUA**. Initially, all of the uronic acids are GlcUA, but a 5'-epimerase converts approximately 90% of the GlcUA residues to IdUA after the polysaccharide chain is formed. The protein molecule of the heparin proteoglycan is unique, consisting exclusively of serine and glycine residues. Approximately, two-thirds of the serine residues contain GAG chains, usually of 5 to 15 kDa but occasionally much larger. Heparin is found in the granules of **mast cells** and also in liver, lung, and skin. It is an important **anticoagulant**. It is released into the blood from capillary walls by the action of lipoprotein lipase and it binds with factors IX and XI, but its most important interaction is with **plasma antithrombin** (discussed in [Chapter 55](#)).

Heparan Sulfate

This molecule is present in a proteoglycan found on many extracellular **cell surfaces**. It contains **GlcN** with fewer *N*-sulfates than heparin, and, unlike heparin, its predominant uronic acid is **GlcUA**. **Heparan sulfates** are associated with the plasma membrane of cells, with their core proteins actually spanning that membrane. In this, they may act as **receptors** and may also participate in the mediation of the **cell growth** and **cell–cell communication**. The attachment of cells to their substratum in culture is mediated at least in part by heparan sulfate. This proteoglycan is also found in the **basement membrane of the kidney** along with type IV collagen and laminin (see above), where it plays a major role in determining the charge selectiveness of glomerular filtration.

Dermatan Sulfate

This substance is widely distributed in animal tissues. Its structure is similar to that of chondroitin sulfate, except that in place of a GlcUA in β -1,3 linkage to GalNAc it contains an **IdUA** in an α -1,3 linkage to **GalNAc**. Formation of the IdUA occurs, as in heparin and heparan sulfate, by 5'-epimerization of GlcUA. Because this is regulated by the degree of sulfation and because sulfation is incomplete, dermatan sulfate contains **both** IdUA-GalNAc and GlcUA-GalNAc disaccharides. **Dermatan sulfate** has a widespread distribution in tissues, and is the main GAG in skin. Evidence suggests it may play a part in blood coagulation, wound repair, and resistance to infection.

Proteoglycans are also found in **intracellular locations** such as the nucleus where they are thought to have a regulatory role in functions such as cell proliferation and transport of molecules between the nucleus and the cytosol. The various functions of GAGs are summarized in **Table 50–7**.

TABLE 50–7 Some Functions of Glycosaminoglycans and Proteoglycans

- Act as structural components of the ECM
- Have specific interactions with collagen, elastin, fibronectin, laminin, and other proteins such as growth factors
- As polyanions, bind polycations and cations
- Contribute to the characteristic turgor of various tissues
- Act as sieves in the ECM
- Facilitate cell migration (HA)
- Have role in compressibility of cartilage in weight bearing (HA, CS)
- Play role in corneal transparency (KS I and DS)
- Have structural role in sclera (DS)
- Act as anticoagulant (heparin)
- Are components of plasma membranes, where they may act as receptors and participate in cell adhesion and cell–cell interactions (eg, HS)
- Determine charge selectiveness of renal glomerulus (HS)
- Are components of synaptic and other vesicles (eg, HS)
- Have a role in nuclear functions such as cell proliferation and transport of molecules between the nucleus and the cytosol

Deficiencies of Enzymes That Degrade Glycosaminoglycans Result in Mucopolysaccharidoses

Both **exo-** and **endoglycosidases** degrade GAGs. Like most other biomolecules, GAGs are subject to **turnover**, being both synthesized and degraded. In adult tissues, GAGs generally exhibit relatively **slow** turnover, their half-lives being days to weeks.

Understanding of the degradative pathways for GAGs, as in the case of glycoproteins (see [Chapter 46](#)) and glycosphingolipids (see [Chapter 24](#)), has been greatly aided by elucidation of the specific enzyme deficiencies that occur in certain **inborn errors of metabolism**. When GAGs are involved, these inborn errors are called **mucopolysaccharidoses (MPSs)** ([Table 50–8](#)).

TABLE 50–8 The Mucopolysaccharidoses

Disease Name	Abbreviation ^a	Enzyme Defective	GAG(s) Affected	Symptoms
Hurler-, Scheie- Hurler-Scheie syndrome	MPS I	α -L-Iduronidase	Dermatan sulfate, heparan sulfate	Mental retardation, coarse facial features, hepatosplenomegaly, cloudy cornea
Hunter syndrome	MPS II	Iduronate sulfatase	Dermatan sulfate, heparan sulfate	Mental retardation
Sanfilippo syndrome A	MPS IIIA	Heparan sulfate-N-sulfatase ^b	Heparan sulfate	Delay in development, motor dysfunction
Sanfilippo syndrome B	MPS IIIB	α -N-Acetylglucosaminidase	Heparan sulfate	As MPS IIIA
Sanfilippo syndrome C	MPS IIIC	α -Glucosaminide N-acetyltransferase	Heparan sulfate	As MPS IIIA
Sanfilippo syndrome D	MPS IIID	N-Acetylglucosamine 6-sulfatase	Heparan sulfate	As MPS IIIA
Morquio syndrome A	MPS IVA	Galactosamine 6-sulfatase	Keratan sulfate, chondroitin 6-sulfate	Skeletal dysplasia, short stature
Morquio syndrome B	MPS IVB	β -Galactosidase	Keratan sulfate	As MPS IVA
Maroteaux-Lamy syndrome	MPS VI	N-Acetylgalactosamine 4-sulfatase ^c	Dermatan sulfate	Curvature of the spine, short stature, skeletal dysplasia, cardiac defects
Sly syndrome	MPS VII	β -Glucuronidase	Dermatan sulfate, heparan sulfate, chondroitin 4-sulfate, chondroitin 6-sulfate	Skeletal dysplasia, short stature, hepatomegaly, cloudy cornea
Natowicz syndrome	MPS IX	Hyaluronidase	Hyaluronic acid	Joint pain, short stature

Degradation of GAGs is carried out by a battery of **lysosomal**

hydrolases. These include **endoglycosidases, exoglycosidases, and sulfatases**, generally acting in sequence. The **MPSs** (Table 50–8) share a common mechanism of causation involving a mutation in a gene encoding a lysosomal hydroxylase responsible for the degradation of one or more GAGs. This leads to a defect in the enzyme and the accumulation of the substrate GAGs in various tissues, including the liver, spleen, bone, skin, and the central nervous system. The diseases are usually inherited in an **autosomal recessive** manner, with **Hurler** and **Hunter syndromes** being perhaps the most widely studied. None is common. In general, these conditions are chronic and progressive and affect multiple organs. Many patients exhibit organomegaly (eg, hepato- and splenomegaly); severe abnormalities in the development of cartilage and bone; abnormal facial appearance; and mental retardation. In addition, defects in hearing, vision, and the cardiovascular system may be present. Diagnostic tests include analysis of GAGs in urine or tissue biopsy samples; assay of suspected defective enzymes in white blood cells, fibroblasts or serum; and test for specific genes. Prenatal diagnosis is now sometimes possible using amniotic fluid cells or chorionic villus biopsy samples. In some cases, a **family history** of a mucopolysaccharidosis is obtained.

The term “**mucolipidosis**” was introduced to denote diseases that combined features common to both mucopolysaccharidoses and sphingolipidoses (see Chapter 24). In **sialidosis** (mucolipidosis I, ML-I), various oligosaccharides derived from glycoproteins and certain gangliosides accumulate in tissues. **I-cell disease** (ML-II) and **pseudo-Hurler polydystrophy** (MLIII) are described in Chapter 46. The term “mucolipidosis” is retained because it is still in relatively widespread clinical usage, but it is not appropriate for these two latter diseases since the mechanism of their causation involves **mislocation** of certain lysosomal enzymes. Genetic defects of the catabolism of the oligosaccharide chains of glycoproteins (eg, mannosidosis, fucosidosis) are also described in Chapter 46. Most of these defects are characterized by increased excretion of various fragments of glycoproteins in the urine, which accumulate because of the metabolic block, as in the case of the mucolipidoses.

Hyaluronidase is one important enzyme involved in the catabolism of both hyaluronic acid and chondroitin sulfate. It is a widely distributed endoglycosidase that cleaves hexosaminidic linkages. From hyaluronic acid, the enzyme will generate a tetrasaccharide with the structure $(\text{GlcUA}\beta\text{-1,3-GlcNAc}\beta\text{-1,4})_2$, which can be degraded further by a β -glucuronidase and β -*N*-acetylhexosaminidase. A genetic defect in

hyaluronidase causes MPS IX, a lysosomal storage disorder in which hyaluronic acid accumulates in the joints.

Proteoglycans Are Associated With Major Diseases & With Aging

Hyaluronic acid may be important in permitting **tumor cells to migrate** through the ECM. Tumor cells can induce fibroblasts to synthesize greatly increased amounts of this GAG, thereby facilitating their own spread. Some tumor cells have less heparan sulfate at their surfaces, and this may play a role in the **lack of adhesiveness** that these cells display.

The intima of the **arterial wall** contains hyaluronic acid and chondroitin sulfate, dermatan sulfate, and heparan sulfate proteoglycans. Of these proteoglycans, dermatan sulfate binds plasma low-density lipoproteins. In addition, dermatan sulfate appears to be the major GAG synthesized by arterial smooth muscle cells. Because these cells proliferate in **atherosclerotic lesions** in arteries, dermatan sulfate may play an important role in development of the atherosclerotic plaque.

In various types of **arthritis**, proteoglycans may act as **autoantigens**, thus contributing to the pathologic features of these conditions. The amount of chondroitin sulfate in cartilage diminishes with age, whereas the amounts of keratan sulfate and hyaluronic acid increase. These changes may contribute to the development of **osteoarthritis**, as may increased activity of the enzyme aggrecanase, which acts to degrade aggrecan. Changes in the amounts of certain GAGs in the skin help to account for its characteristic alterations with **aging**.

In the past few years, it has become clear that in addition to their structural role in the ECM, proteoglycans function as signaling molecules which influence cell behavior, and they are now believed to play a part in diverse diseases such as fibrosis, cardiovascular disease, and cancer.

BONE IS A MINERALIZED CONNECTIVE TISSUE

Bone contains both **organic** and **inorganic** material. The **organic** matter is mainly **protein**. The principal proteins of bone are listed in **Table 50–9**; **type I collagen** is the major protein, comprising 90 to 95% of the organic material. Type V collagen is also present in small amounts, as are a number of noncollagen proteins, some of which are relatively specific to bone. These are now believed to play an active part of the mineralization

process. The **inorganic** or mineral component is mainly crystalline **hydroxyapatite**— $\text{Ca}_{10}(\text{PO}_4)_6(\text{OH})_2$ —along with sodium, magnesium, carbonate, and fluoride; approximately 99% of the body’s calcium is contained in bone (see [Chapter 44](#)). Hydroxyapatite confers on bone the strength and resilience required for its physiologic roles.

TABLE 50–9 The Principal Proteins Found in Bone^a

Proteins	Comments
Collagens	
Collagen type I	Approximately 90% of total bone protein. Composed of two $\alpha 1(I)$ and one $\alpha 2(I)$ chains.
Collagen type V	Minor component.
Noncollagen proteins	
Plasma proteins	Mixture of various plasma proteins.
Proteoglycans ^b CS-PG I (biglycan)	Contains two GAG chains; found in other tissues.
CS-PG II (decorin)	Contains one GAG chain; found in other tissues.
CS-PG III	Bone-specific.
Bone SPARC ^c protein (osteonectin)	Not bone-specific.
Osteocalcin (bone Gla protein)	Contains γ -carboxyglutamate (Gla) residues that bind to hydroxyapatite. Bone-specific.
Osteopontin	Not bone-specific. Glycosylated and phosphorylated.
Bone sialoprotein	Bone-specific. Heavily glycosylated, and sulfated on tyrosine.
Bone morphogenetic proteins (BMPs)	A family (at least 20) of secreted proteins with a variety of actions on bone; many induce ectopic bone growth.
Osteoprotegerin	Inhibits osteoclastogenesis

Bone is a **dynamic structure** that undergoes continuing cycles of remodeling, consisting of resorption (demineralization) followed by deposition of new bone tissue (mineralization). This remodeling permits bone to adapt to both physical (eg, increases in weight bearing) and hormonal signals.

The major cell types involved in bone resorption and deposition are **osteoclasts** and **osteoblasts**, respectively ([Figure 50–12](#)). **Osteocytes** are found in mature bone and are also involved in the maintenance of the bone matrix. They are descended from osteoblasts and are very long-lived, with an average half-life of 25 years.

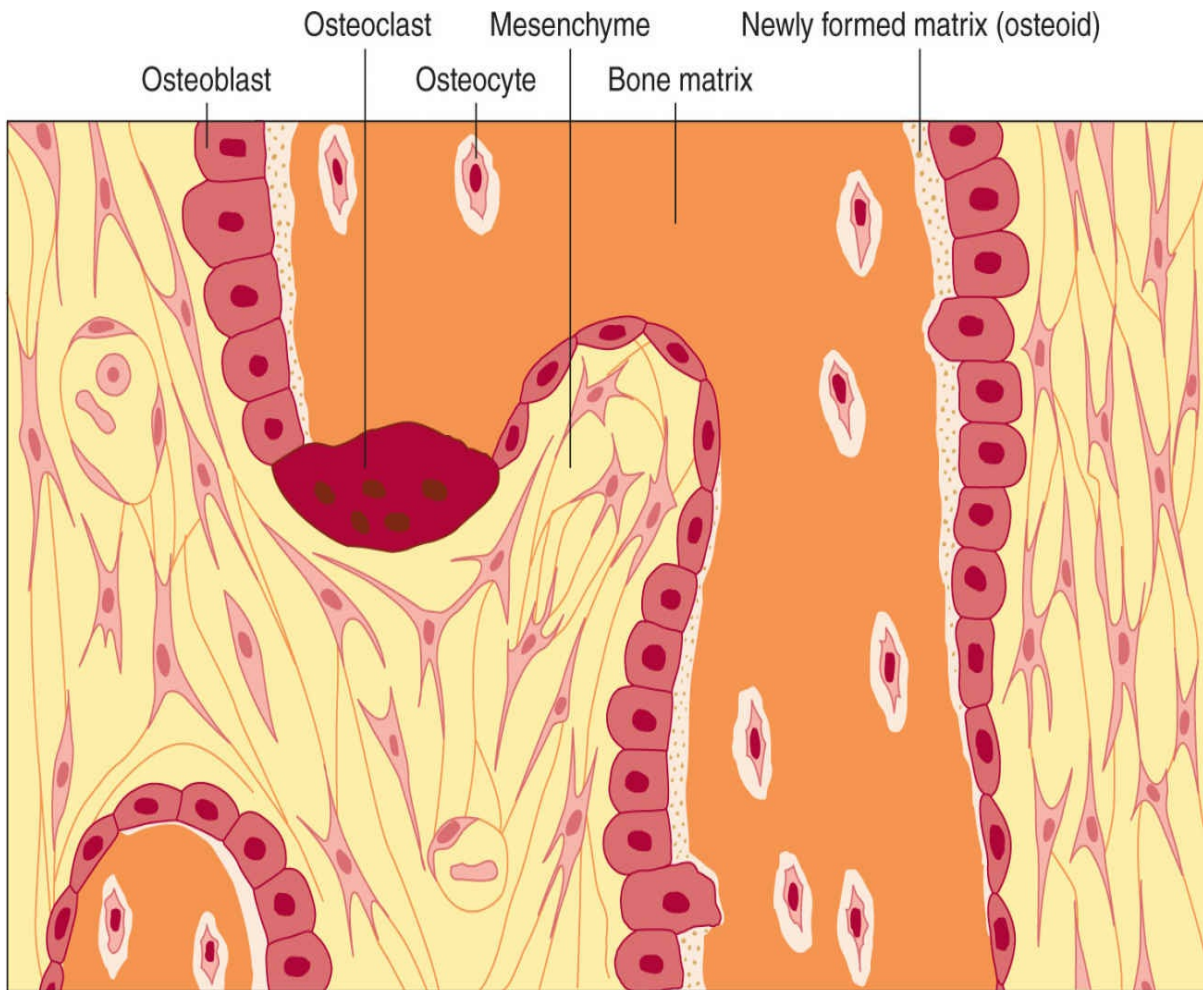

FIGURE 50–12 Schematic illustration of the major cells present in the membranous bone. Osteoblasts (lighter color) are synthesizing type I collagen, which forms a matrix that traps cells. As this occurs, osteoblasts gradually differentiate to become osteocytes. (Reproduced, with permission, from Junqueira LC, Carneiro J: *Basic Histology: Text & Atlas*, 10th ed. McGraw-Hill, 2003.)

Osteoclasts are multinucleated cells derived from pluripotent hematopoietic stem cells. Osteoclasts possess an apical membrane domain, exhibiting a ruffled border that plays a key role in bone resorption (**Figure 50–13**). A special proton-translocating **ATPase** expels protons across the ruffled border into the resorption area, which is the microenvironment of low pH shown in the figure. This lowers the local pH to 4.0 or less, thus increasing the solubility of hydroxyapatite and helping its breakdown into Ca^{2+} , H_3PO_4 and H_2CO_3 , and water, thus allowing demineralization to occur. Lysosomal acid proteases such as cathepsins are also released to digest the now accessible matrix proteins. **Osteoblasts**—mononuclear

cells derived from pluripotent mesenchymal precursors—synthesize most of the proteins found in bone (Table 50–9) as well as various growth factors and cytokines. They are responsible for the deposition of the new bone matrix (osteoid) and its subsequent mineralization. Osteoblasts **control mineralization** by regulating the passage of calcium and phosphate ions across their surface membranes. **Alkaline phosphatase**, an enzyme in the cell membrane, generates phosphate ions from organic phosphates. The mechanisms involved in mineralization are not fully understood, but a number of factors, including **tissue nonspecific alkaline phosphatase (TNAP)**, an isoenzyme of alkaline phosphatase, matrix vesicles, which contain calcium and phosphate and bud off from the osteoblast membrane and **type I collagen** have been implicated. Mineralization first becomes evident in the gaps between successive collagen molecules. **Acidic phosphoproteins**, such as **bone sialoprotein and osteopontin**, are thought to act as sites of nucleation. These proteins contain RGD sequences for cell attachment and motifs (eg, poly-Asp and poly-Glu stretches) that bind calcium and may provide an initial scaffold for mineralization. Some macromolecules, such as certain proteoglycans and glycoproteins, can also act as **inhibitors** of nucleation.

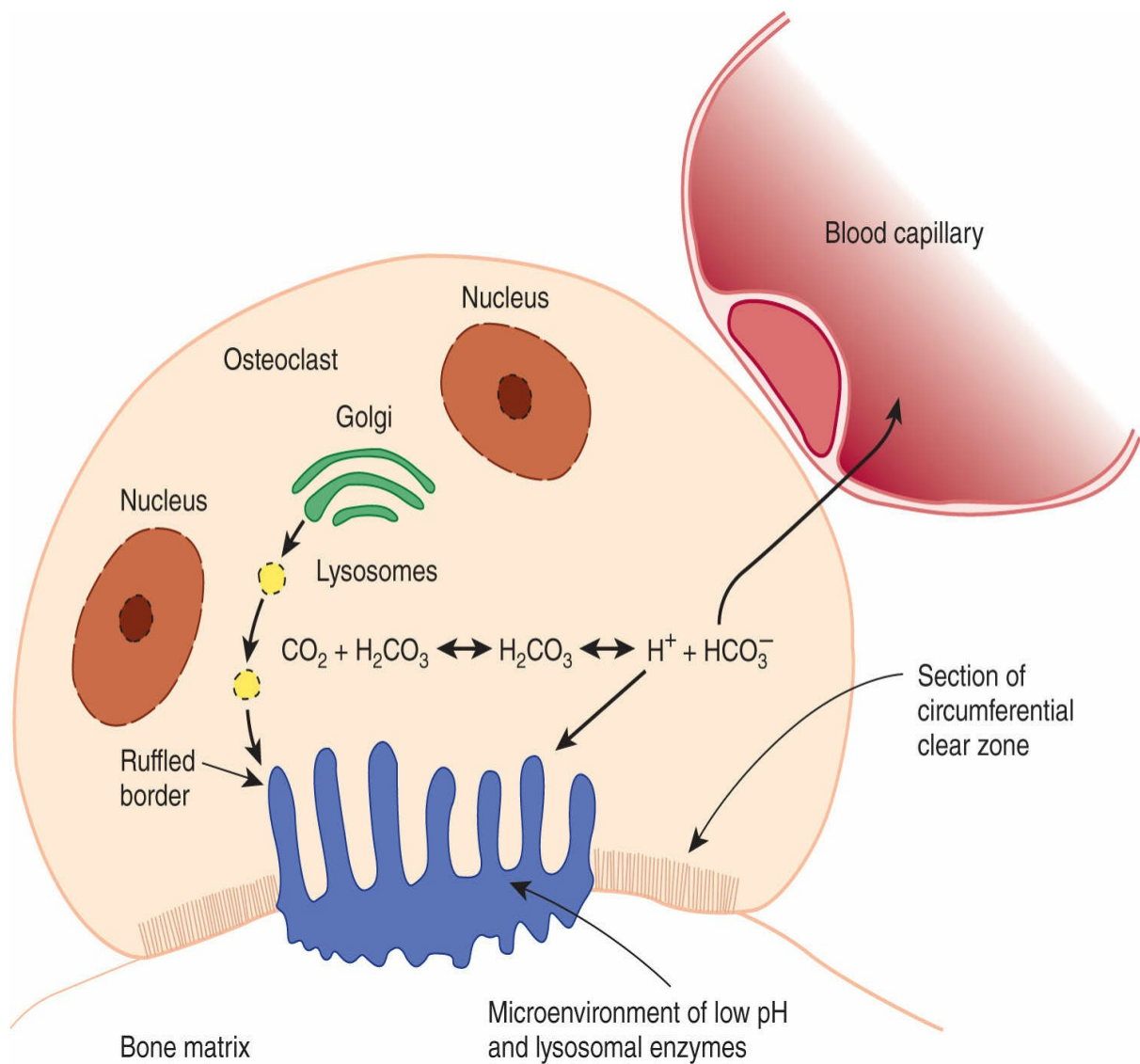

FIGURE 50–13 Schematic illustration of the role of the osteoclast in bone resorption. Lysosomal enzymes and hydrogen ions are released into the confined microenvironment created by the attachment between the bone matrix and the peripheral clear zone of the osteoclast. The acidification of this confined space facilitates the dissolution of calcium phosphate from bone and is the optimal pH for the activity of lysosomal hydrolases. The bone matrix is thus removed, and the products of bone resorption are taken up into the cytoplasm of the osteoclast, probably digested further, and transferred into capillaries. The chemical equation shown refers to the action of carbonic anhydrase II, described in the text. (Reproduced, with permission, from Junqueira LC, Carneiro J: *Basic Histology: Text & Atlas*, 10th ed. McGraw-Hill, 2003.)

Bone consists of two types of tissue, **trabecular (also called cancellous or spongy) bone** is found at the end of long bones close to the

joints and is less dense than **compact (or cortical) bone**, which, as well as being denser, is harder and stronger. It forms the cortex (or outer shell) of most bones and accounts for about 80% of the weight of the human skeleton. It is estimated that approximately 4% of compact bone and 20% of trabecular bone is **renewed annually** in the typical healthy adult. Many factors are involved in the **regulation of bone metabolism**. Some of which **stimulate osteoblast activity** (eg, parathyroid hormone and 1,25-dihydroxycholecalciferol [see [Chapter 44](#)]) to promote mineralization, while others **inhibit** it (eg, corticosteroids). Parathyroid hormone and 1,25-dihydroxycholecalciferol also stimulate bone resorption by increasing osteoclast activity, whereas calcitonin and estrogens have the opposite effect.

BONE IS AFFECTED BY MANY METABOLIC & GENETIC DISORDERS

A number of metabolic and genetic disorders affect bone, and some of the more important examples are listed in [Table 50–10](#).

TABLE 50–10 Some Metabolic and Genetic Diseases Affecting Bone and Cartilage

Condition	Causes	Condition	Causes
Dwarfism	Often deficiency of growth hormone, but many other causes	Osteoporosis	Age-related, estrogen deficiency following menopause, mutations in genes affecting bone metabolism, ^a including the vitamin D receptor (<i>VDR</i>), estrogen receptor- α (<i>ER-α</i>), and <i>COL1A1</i>
Rickets	Deficiency of vitamin D in childhood	Osteoarthritis	Age-related cartilage degeneration, mutations in various genes ^a including <i>VDR</i> , <i>ER-α</i> , and <i>COL2A1</i>
Osteomalacia	Deficiency of vitamin D in adults	Chondrodysplasias	Mutations in <i>COL2A1</i>
Hyperparathyroidism	Excess parathyroid hormone causing bone resorption	Pfeiffer, Jackson-Weiss, and Crouzon syndromes ^b	Mutations in the gene for fibroblast growth factor receptor (<i>FGFR</i>) 1 and/or 2
Osteogenesis imperfecta	Mutations in <i>COL1A1</i> and <i>COL1A2</i> affecting the synthesis and structure of collagen	Achondroplasia and thanatophoric dysplasia ^c	Mutation in the gene for <i>FGFR3</i>

Osteogenesis imperfecta (brittle bones) is characterized by abnormal fragility of bones. The sclera of the eye is often abnormally thin and translucent and may appear blue owing to a deficiency of connective tissue. **Eight types** (I-VIII) of this condition have been recognized. Types

I to IV are caused by mutations in the *COL1A1* or *COL1A2* genes or both. Type I is mild, but type II is severe and infants born with the condition usually do not survive, and types III and IV are progressive and/or deforming. Over 100 mutations in these two genes have been documented and include partial gene deletions and duplications. Other mutations affect RNA splicing, and the most frequent type results in the **replacement of glycine** by another bulkier amino acid, affecting formation of the triple helix. In general, these mutations result in decreased expression of collagen or in structurally abnormal pro chains that assemble into **abnormal fibrils**, weakening the overall structure of bone. When one abnormal chain is present, it may interact with two normal chains, but folding may be prevented, resulting in enzymatic degradation of all of the chains. This is called “**procollagen suicide**” and is an example of a dominant negative mutation, a result often seen when a protein consists of multiple different subunits. Types V to VIII are less common and are caused by mutations in the genes for proteins involved in bone mineralization other than collagen.

Osteopetrosis (marble bone disease), characterized by **increased bone density**, is a rare condition characterized by inability to resorb bone. It is due to mutations in the gene (located on chromosome 8q22) encoding **carbonic anhydrase II** (CA II), one of four isozymes of carbonic anhydrase present in human tissues. Deficiency of CA II in osteoclasts prevents normal bone resorption, and osteopetrosis results.

Osteoporosis is a generalized progressive reduction in bone tissue mass per unit volume, caused by an imbalance between bone resorption and deposition, and leads to skeletal weakness. The primary type 1 condition commonly occurs in women after the menopause. This is thought to be mainly due to lack of estrogen, which promotes bone resorption and decreases bone mineralization. Primary type 2 or senile osteoporosis occurs in both sexes post 75 years, although is more prevalent in women (ratio 2:1 female:male). The ratio of **mineral** to **organic elements** is unchanged in the remaining normal bone. Fractures of various bones, such as the head of the femur, occur very easily and represent a huge burden to both the affected patients and to society in general.

THE MAJOR COMPONENTS OF CARTILAGE ARE TYPE II COLLAGEN & CERTAIN PROTEOGLYCANS

There are three types of cartilage. The major type is **hyaline (articular) cartilage** and its principal proteins are listed in **Table 50–11**. **Type II collagen** is the major protein component (**Figure 50–14**), and a number of other minor types of collagen are also present. In addition to these components, the second type, **elastic cartilage**, contains elastin, and the third, **fibroelastic cartilage**, contains type I collagen. Cartilage contains a number of **proteoglycans**, which play an important role in its compressibility. **Aggrecan** (about 2×10^3 kDa) is the major proteoglycan. As shown in **Figure 50–15**, it has a very complex structure, containing several GAGs (hyaluronic acid, chondroitin sulfate, and keratan sulfate) and both link and core proteins. The core protein contains three domains: A, B, and C. Hyaluronic acid binds noncovalently to domain A of the core protein as well as to the link protein, which stabilizes the hyaluronate–core protein interactions. The keratan sulfate chains are located in domain B, whereas the chondroitin sulfate chains are located in domain C; both of these types of GAGs are bound covalently to the core protein. The core protein also contains both *O*- and *N*-linked oligosaccharide chains.

TABLE 50–11 The Principal Proteins Found in Cartilage

Proteins	Comments
Collagen proteins	
Collagen type II	90–98% of total hyaline cartilage collagen. Composed of three $\alpha 1(\text{II})$ chains.
Collagens V, VI, IX, X, XI	Type IX cross-links to type II collagen. Type XI may help control diameter of type II fibrils.
Noncollagen proteins	
Cartilage oligomeric matrix protein (COMP)	An important structural component of cartilage. Regulates cell movement and attachment.
Aggrecan	The major proteoglycan of cartilage.
DS-PG I (biglycan) ^a	Similar to CS-PG I of bone.
DS-PG II (decorin)	Similar to CS-PG II of bone.
Chondronectin	Promotes chondrocyte attachment to type II collagen

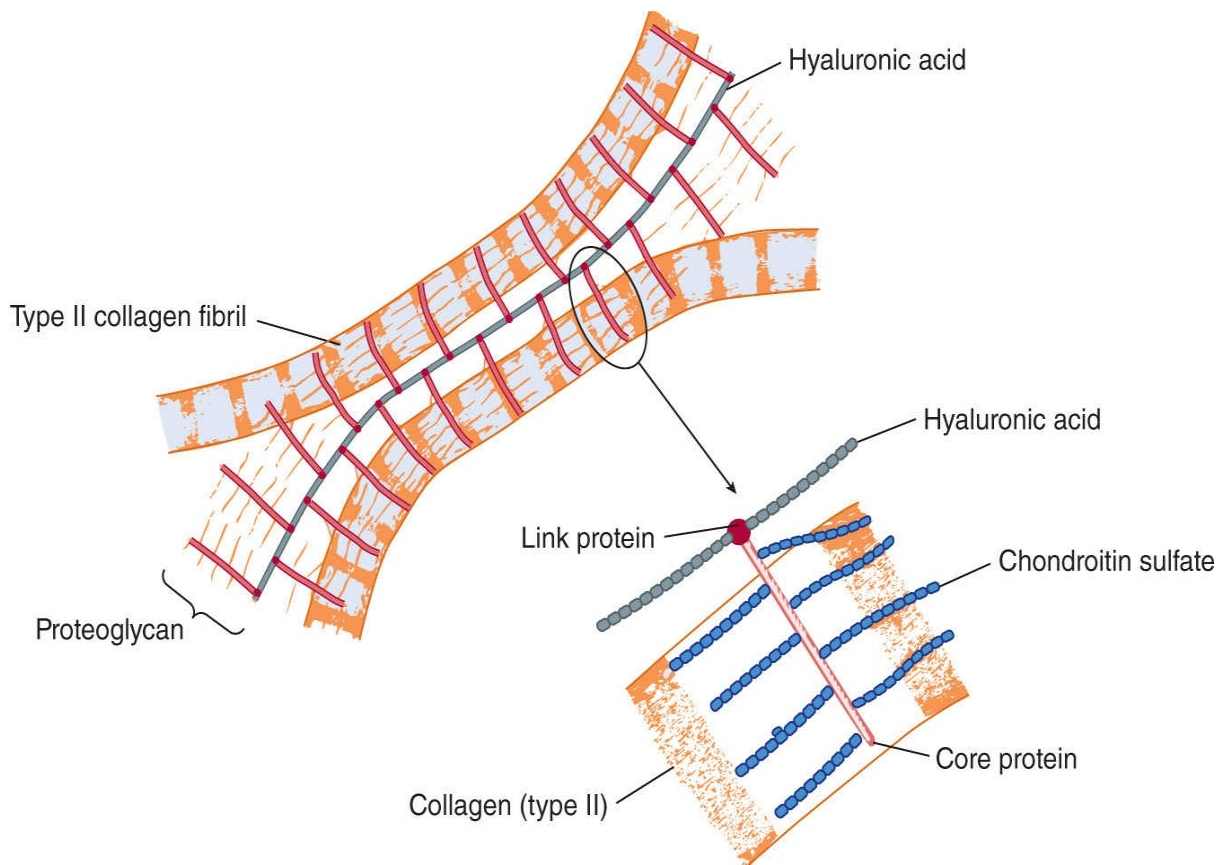

FIGURE 50–14 Schematic representation of the molecular organization in the cartilage matrix. Link proteins noncovalently bind the core protein (red) of proteoglycans to the linear hyaluronic acid molecules (gray). The chondroitin sulfate side chains of the proteoglycan electrostatically bind to the collagen fibrils, forming a cross-linked matrix. The oval outlines the area enlarged in the lower part of the figure. (Reproduced, with permission, from Junqueira LC, Carneiro J: *Basic Histology: Text & Atlas*, 10th ed. McGraw-Hill, 2003.)

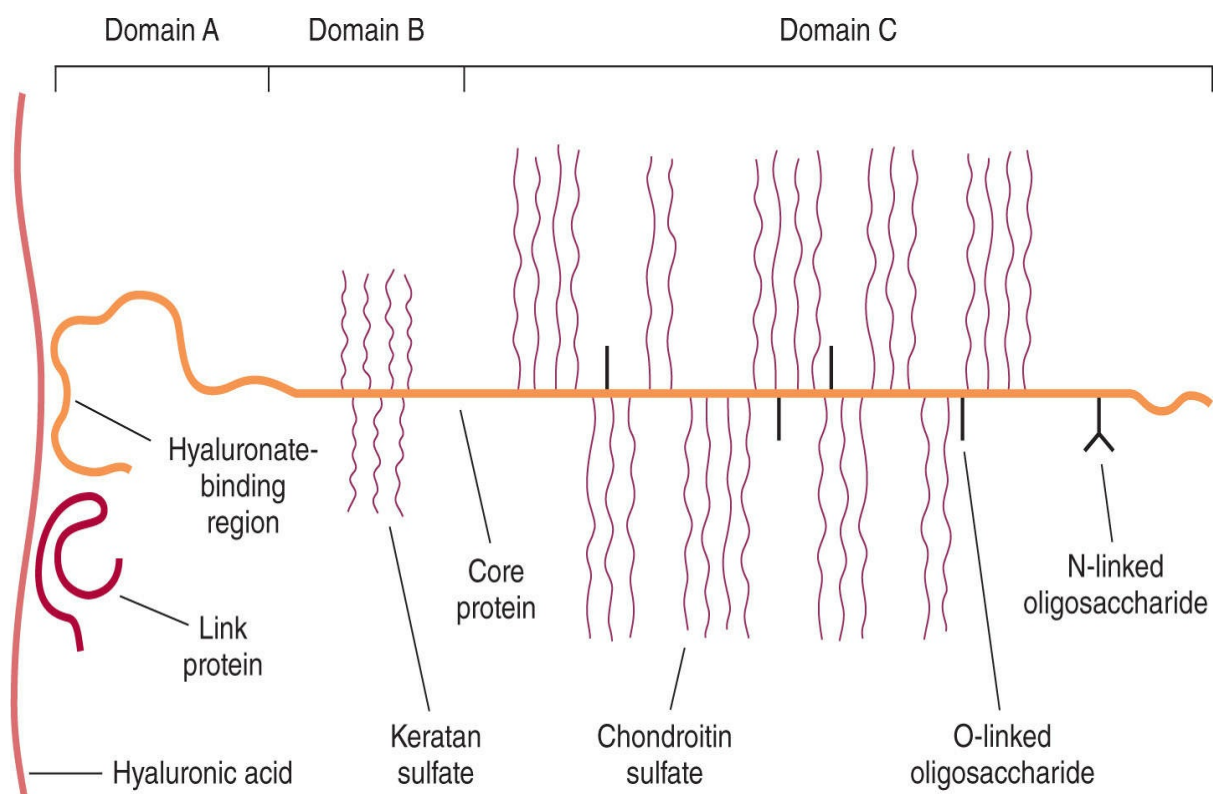

FIGURE 50–15 Schematic diagram of aggrecan. A strand of hyaluronic acid is shown on the left. The core protein (about 210 kDa) has three major domains. Domain A, at its amino-terminal end, interacts with approximately five repeating disaccharides in hyaluronate. The link protein interacts with both hyaluronate and domain A, stabilizing their interactions. Approximately 30 keratan sulfate chains are attached, via GalNAc-Ser linkages, to domain B. Domain C contains about 100 chondroitin sulfate chains attached via Gal-Gal-Xyl-Ser linkages and about 40 O-linked oligosaccharide chains. One or more N-linked glycan chains are also found near the carboxyl terminal of the core protein. (Moran LA, et al: *Biochemistry*, 2nd ed., © 1994, pp. 9–43. Adapted by permission of Pearson Education, Inc., Upper Saddle River, NJ.)

The other proteoglycans found in cartilage have simpler structures than aggrecan.

Chondronectin is involved in the attachment of type II collagen to chondrocytes (the cells in cartilage).

Cartilage is an avascular tissue and obtains most of its nutrients from synovial fluid. It exhibits slow but continuous **turnover**. Various **proteases** (eg, collagenases and stromelysin) synthesized by chondrocytes can **degrade collagen** and the other proteins found in cartilage. Interleukin-1 (IL-1) and tumor necrosis factor α (TNF- α) appear to

stimulate the production of such proteases, whereas TGF- β and insulin-like growth factor 1 (IGF-I) generally exert an anabolic influence on the cartilage.

CHONDRODYSPLASIAS ARE CAUSED BY MUTATIONS IN GENES ENCODING TYPE II COLLAGEN & FIBROBLAST GROWTH FACTOR RECEPTORS

Chondrodysplasias are a mixed group of hereditary disorders affecting cartilage. They are manifested by short-limbed dwarfism and numerous skeletal deformities. A few are due to a variety of mutations in the *COL2A1* gene, leading to abnormal forms of type II collagen. One example is the **Stickler syndrome**, manifested by degeneration of the joint cartilage and of the vitreous body of the eye.

The best known of the chondrodysplasias is **achondroplasia**, the most common cause of **short-limbed dwarfism**. Affected individuals have short limbs, normal trunk size, macrocephaly, and a variety of other skeletal abnormalities. The condition is often inherited as an autosomal dominant trait, but many cases are due to new mutations. Achondroplasia is not a collagen disorder but is due to mutations in the gene encoding **fibroblast growth factor receptor 3 (FGFR3)**. **Fibroblast growth factors** are a family of more than 20 proteins that affect the growth and differentiation of cells of mesenchymal and neuroectodermal origin. Their **receptors** are transmembrane proteins and form a subgroup of four in the family of receptor tyrosine kinases. FGFR3 is one member of this subgroup and mediates the actions of FGF3 on cartilage. In almost all cases of achondroplasia that have been investigated, the mutations were found to involve nucleotide 1138 and resulted in substitution of arginine for glycine (residue number 380) in the transmembrane domain of the protein, rendering it inactive. No such mutation was found in unaffected individuals.

Other mutations in the same gene can result in **hypochondroplasia**, **thanatophoric dysplasia** (types I and II) (other forms of short-limbed dwarfism), and the **SADDAN phenotype** (severe achondroplasia with developmental delay and acanthosis nigricans [the latter is a brown to black hyperpigmentation of the skin]).

As indicated in [Table 50–10](#), **other skeletal dysplasias** (including certain craniosynostosis syndromes) are also due to mutations in genes

encoding FGF receptors. Another type of skeletal dysplasia, **diastrophic dysplasia** has been found to be due to mutation in a sulfate transporter.

SUMMARY

- The major components of the ECM are the structural proteins collagen, elastin, and fibrillin-1, a number of specialized proteins (eg, fibronectin and laminin), and various proteoglycans.
- Collagen is the most abundant protein in the animal kingdom; approximately 28 types have been isolated. All collagens contain greater or lesser stretches of triple helix and the repeating structure (Gly-X-Y)*n*.
- The biosynthesis of collagen is complex, featuring many posttranslational events, including hydroxylation of proline and lysine.
- Diseases associated with impaired synthesis of collagen include scurvy, osteogenesis imperfecta, Ehlers-Danlos syndrome (six subtypes), and Menkes disease.
- Elastin confers extensibility and elastic recoil on tissues. Elastin lacks hydroxylysine, Gly-X-Y sequences, triple helical structure, and sugars, but contains desmosine and isodesmosine cross-links not found in collagen.
- Fibrillin-1 is located in microfibrils. Mutations in the gene encoding fibrillin-1 cause Marfan syndrome. The cytokine TGF- β appears to contribute to the cardiovascular pathology.
- The GAGs are made up of repeating disaccharides containing a uronic acid (glucuronic or iduronic) or hexose (galactose) and a hexosamine (galactosamine or glucosamine). Sulfate is also frequently present.
- The major GAGs are hyaluronic acid, chondroitin 4- and 6-sulfates, keratan sulfates I and II, heparin, heparan sulfate, and dermatan sulfate.
- The GAGs are synthesized by the sequential actions of specific enzymes (glycosyltransferases, epimerases, sulfotransferases, etc) and are degraded by the sequential action of lysosomal hydrolases. Genetic deficiencies of the latter result in mucopolysaccharidoses (eg, the Hurler syndrome).
- GAGs occur in tissues bound to various proteins (linker proteins and core proteins), constituting proteoglycans. These structures are often of very high molecular weight and serve many functions in tissues.
- Many components of the ECM bind to integrins, proteins found on the

cell surface and this constitutes one pathway by which the cell exterior can communicate with the interior.

- Bone and cartilage are specialized forms of the ECM. Collagen I and hydroxyapatite are the major constituents of bone. Collagen II and certain proteoglycans are major constituents of cartilage.
- A number of heritable diseases of bone (eg, osteogenesis imperfecta) and of cartilage (eg, the chondrodystrophies) are caused by mutations in the genes for collagen and proteins involved in bone mineralization and cartilage formation.

REFERENCES

Kadler KE, Baldock C, Bella J, Boot-Handford RP: Collagens at a glance. *J Cell Sci* 2007;120:1955.

Kasper DL, Fauci AS, Hauser SL et al: *Harrison's Principles of Internal Medicine*, 19th ed. McGrawHill Education, 2017.

Scriver CR, Beaudet AL, Valle D, et al (editors): *The Metabolic and Molecular Bases of Inherited Disease*, 8th ed. McGraw-Hill, 2001. (This comprehensive four-volume text and the updated online version [www.ommbid.com] contain chapters on disorders of collagen biosynthesis and structure, Marfan syndrome, the mucopolysaccharidoses, achondroplasia, Alport syndrome, and craniosynostosis syndromes.)

Seibel MJ, Robins SP, Bilezikian JP: *Dynamics of Bone and Cartilage Metabolism*. Academic Press, 2006.

Muscle & the Cytoskeleton

Peter J. Kennelly, PhD & Robert K. Murray, MD, PhD

OBJECTIVES

After studying this chapter, you should be able to:

- Describe the differences between actin-based and myosin-based regulation of muscle contraction.
- Outline the composition and organization of the thick and thin filaments in striated muscle tissues.
- Describe the pivotal role of Ca^{2+} in the initiation of both contraction and relaxation in muscle.
- List the various channels, pumps, and exchangers involved in regulating intracellular Ca^{2+} levels in various types of muscle.
- List the major energy sources for regenerating ATP in muscle tissue.
- Identify the preferred energy sources for fast and slow twitch fibers.
- Understand the molecular bases of malignant hyperthermia, Duchenne and Becker muscular dystrophies, and inherited cardiomyopathies.
- Explain how nitric oxide (NO) induces relaxation of vascular

smooth muscle.

- Know the general structures and functions of the major components of the cytoskeleton, namely microfilaments, microtubules, and intermediate filaments.
- Explain the role of mutations in the gene encoding lamin A and lamin in Hutchinson-Gilford progeria syndrome (**progeria**).

BIOMEDICAL IMPORTANCE

The shape, integrity, and internal organization of all mammalian cells is maintained by an internal network of polymeric protein fibers and associated molecular motors called the **cytoskeleton**. This structural and mechanical network mediates motional processes such as cytokinesis, endocytosis, exocytosis, secretion, phagocytosis, and diapedesis. Several pathogenic microorganisms, among them *Yersinia*, *Salmonella enterica*, *Listeria monocytogenes*, and *Shigella* attack or co-opt the cytoskeleton of the infected host as an integral part of their mechanisms of virulence.

Highly specialized muscle cells elaborate extensive internal networks consisting of physically juxtaposed **actin** and **myosin** polymers, or fibrils, that form the core of their contractile apparatus. This mechanically powerful contractile machinery is controlled by signal transduction pathways in which the second messenger Ca^{2+} plays a pivotal role. Muscle tissue is subject to a variety of pathologic conditions, many of them hereditary in nature, including Duchenne-type muscular dystrophy; malignant hyperthermia, a serious complication for some patients undergoing certain types of anesthesia, and cardiomyopathies. **Heart failure** is a very common medical condition, with a variety of causes. Its rational therapy requires understanding of the biochemistry of heart muscle. For example, many widely used **vasodilators**—such as nitroglycerin, used in the treatment of angina pectoris—act by increasing the formation of NO.

MUSCLE IS A STRUCTURALLY AND FUNCTIONALLY SPECIALIZED TISSUE

Three Types of Muscle Exist: Skeletal, Cardiac, and Smooth

Muscle is a highly specialized tissue configured to convert the chemical

energy of ATP potential into mechanical energy on a mass, macroscopic scale. Three types of muscle are found in vertebrates. **Skeletal** and **cardiac** muscle display a striated appearance, a consequence of the parallel alignment of the fibrils of their contractile apparatus. **Smooth** muscle is devoid of striations, a consequence of the (more) random orientation of its contractile fibrils. Mechanically, these differences in orientation mean that cardiac and skeletal muscle contract and exert force in only one dimension, like a coil spring, while contracting smooth muscle contracts exerts force and shortens in all directions, like the polymer skin of an inflated balloon. Skeletal muscle also is under conscious or **voluntary** nervous control, while both cardiac and smooth muscle work in an unconscious, **involuntary** manner.

The Sarcomere Is the Functional Unit of Muscle

Striated muscle is composed of multinucleated muscle fiber cells, which may extend the entire length of the muscle, surrounded by an electrically excitable plasma membrane, the **sarcolemma**. Within each individual muscle fiber cell oriented longitudinally along its length are bundles of parallel **myofibrils**, consisting of interdigitated, overlapping thick and thin filaments, embedded in intracellular fluid termed **sarcoplasm**. When a **myofibril** is examined by electron microscopy, alternating dark and light bands can be observed (**Figure 51–1**).

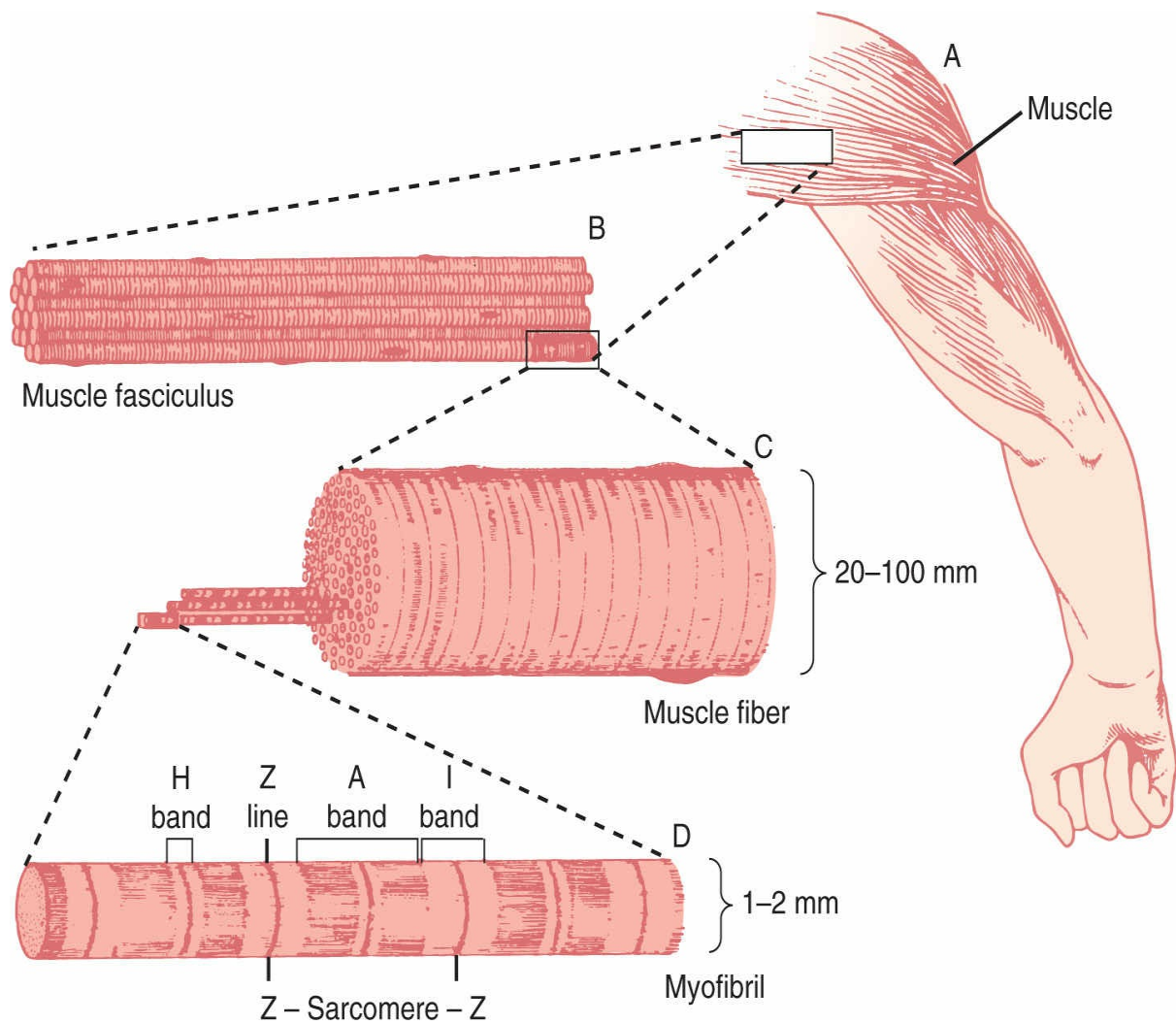

FIGURE 51-1 The structure of voluntary muscle. The sarcomere is the region between the Z lines. (Drawing by Sylvia Colard Keene. Reproduced, with permission, from Bloom W, Fawcett DW: *A Textbook of Histology*, 10th ed. Saunders, 1975.)

These bands are thus referred to as **A** and **I bands**, respectively. In the A band, the thin filaments are arranged around the thick (myosin) filament as a secondary hexagonal array. Each thin filament lies symmetrically between three thick filaments (**Figure 51-2**, center, mid cross section), and each thick filament is surrounded symmetrically by six thin filaments. The central region of the A band, a seemingly less dense region known as the **H band**, consists entirely of thick filaments. The I band corresponds to a zone containing only thin filaments, and is bisected by the dense and narrow **Z line**, which consists of a complex network of polypeptides anchoring the thin filaments together (**Figure 51-2**).

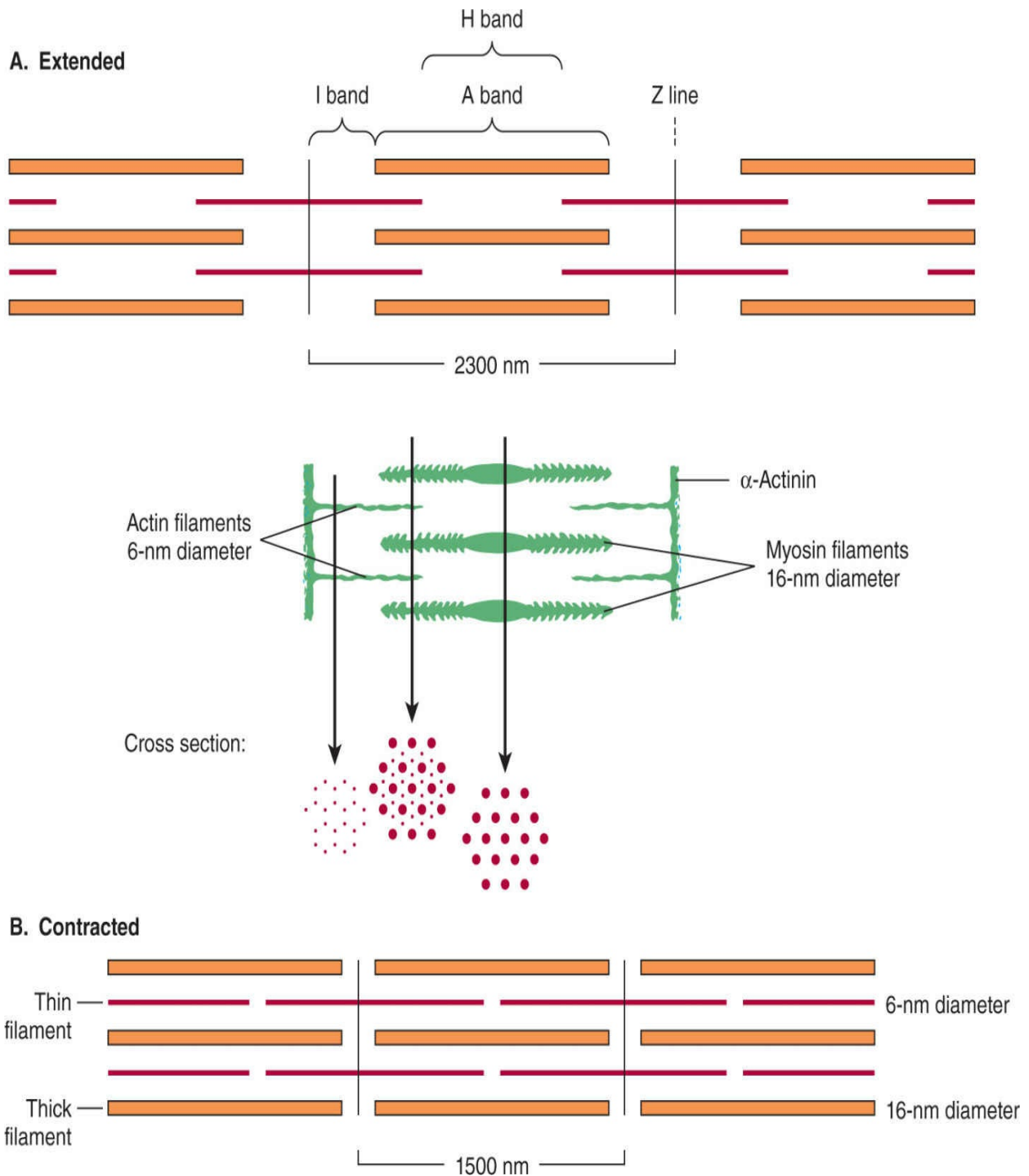

FIGURE 51–2 Arrangement of filaments in striated muscle. (A) Extended. The positions of the I, A, and H bands in the extended state are shown. The thin filaments partly overlap the ends of the thick filaments, and the thin filaments are shown anchored in the Z lines (often called Z disks). In the lower part of [Figure 51–2A](#), “arrowheads,” pointing in opposite directions, are shown emanating from the myosin (thick) filaments. Four actin (thin) filaments are shown attached to two Z lines via α -actinin. The central region of the three myosin filaments, free of arrowheads, is called the M band (not labeled). Cross sections through the

M bands, through an area where myosin and actin filaments overlap and through an area in which solely actin filaments are present, are shown. **(B)** Contracted. The actin filaments are seen to have slipped along the sides of the myosin fibers toward each other. The lengths of the thick filaments (indicated by the A bands) and the thin filaments (distance between Z lines and the adjacent edges of the H bands) have not changed. However, the lengths of the sarcomeres have been reduced (from 2300 to 1500 nm), and the lengths of the H and I bands are also reduced because of the overlap between the thick and thin filaments. These morphologic observations provided part of the basis for the sliding filament model of muscle contraction.

The **sarcomere** is defined as the region between two Z lines (Figures 51-1 and 51-2) and is repeated along the axis of a fibril at distances of 1500 to 2300 nm depending on the state of contraction. Most muscle fiber cells are aligned so that their sarcomeres are in parallel register (Figure 51-1).

Thin and Thick Filaments Slide Past Each Other During Contraction

The sliding filament model was largely based on careful morphologic observations on resting, extended, and contracting muscle. When muscle contracts, the H zones and the I bands shorten (see legend to Figure 51-2). Given that the thin and thick filaments remain intact, it was concluded that the interdigitated filaments slide past one another during contraction. As the tension developed during muscle contraction is proportionate to the degree to which the filaments overlapped, it was apparent that contraction involved a dynamic interaction between the filaments by which they were actively pulled past one another.

ACTIN & MYOSIN

Actin and Myosin Account for 75% of the Protein Mass in Muscle

Actin and myosin contribute 20 and 55% of the protein mass in muscle, respectively. The monomeric form of actin, **G-actin** (43 kDa; G, globular) polymerizes in the presence of Mg^{2+} to form an insoluble double helical filament called F-actin (Figure 51-3).

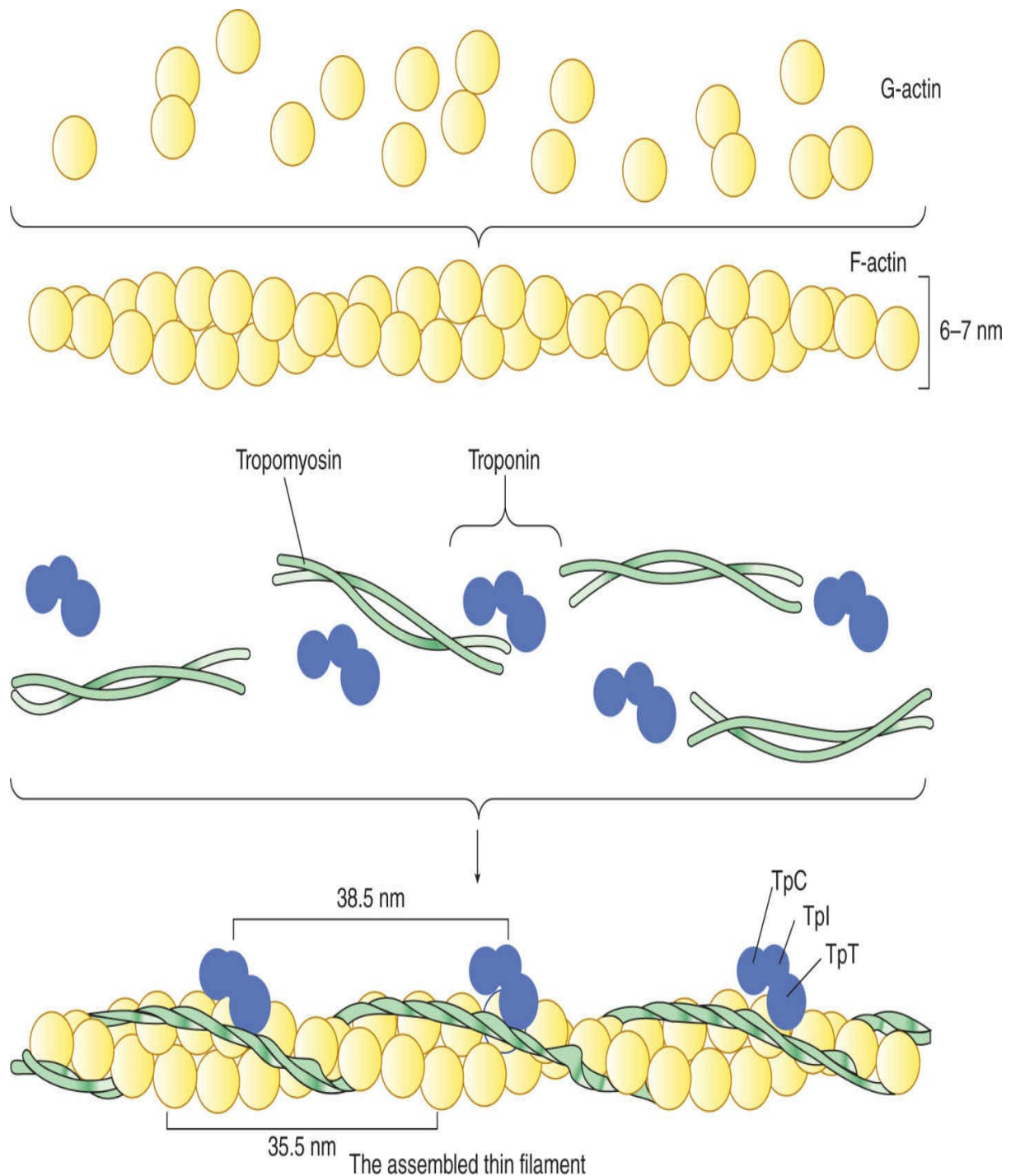

FIGURE 51–3 Schematic representation of the thin filament, showing the spatial configuration of its three major protein components: actin, troponin, and tropomyosin. The upper panel shows individual molecules of G-actin. The middle panel shows actin monomers assembled into F-actin. Individual molecules of tropomyosin (two strands wound around one another) and of troponin (made up of its three subunits) are also shown. The lower panel shows the assembled thin filament, consisting of F-actin, tropomyosin, and the three subunits of troponin (TpC, TpI, and TpT).

The **F-actin** fiber, also known as the thin filament, is 6- to 7-nm thick and has a structure that repeats every 35.5 nm. Humans contain genes encoding 12 classes of myosins. The tissue distribution and relative amounts of these myosin isoforms can vary in different anatomic, physiologic, and pathologic situations.

Myosin-I, which exists in cells as a monomer, links cytoskeletal microfilaments to the plasma membrane. The predominant form of myosin in contractile tissues is **myosin II**, hereafter referred to simply as myosin, an asymmetric hexamer with a molecular mass of ≈ 460 kDa. The hexamer consists of one pair of ≈ 200 kDa **heavy (H) chains**, and two pairs of **light (L) chains**, referred to as essential and regulatory, each with a molecular mass of ≈ 20 kDa. The two heavy chains are intertwined, forming an extended helical tail, each capped by a globular head domain to which the light chains associate (**Figure 51–4**). Myosin possesses low, but detectable levels of **ATPase** activity *in vitro*: the catalysis of the hydrolysis of ATP by water to form ADP and P_i . Low levels of ATPase activity are a common feature of enzymes that employ ATP as a substrate. When skeletal muscle myosin is complexed to actin to form **actomyosin** complex, its ATPase activity greatly increases.

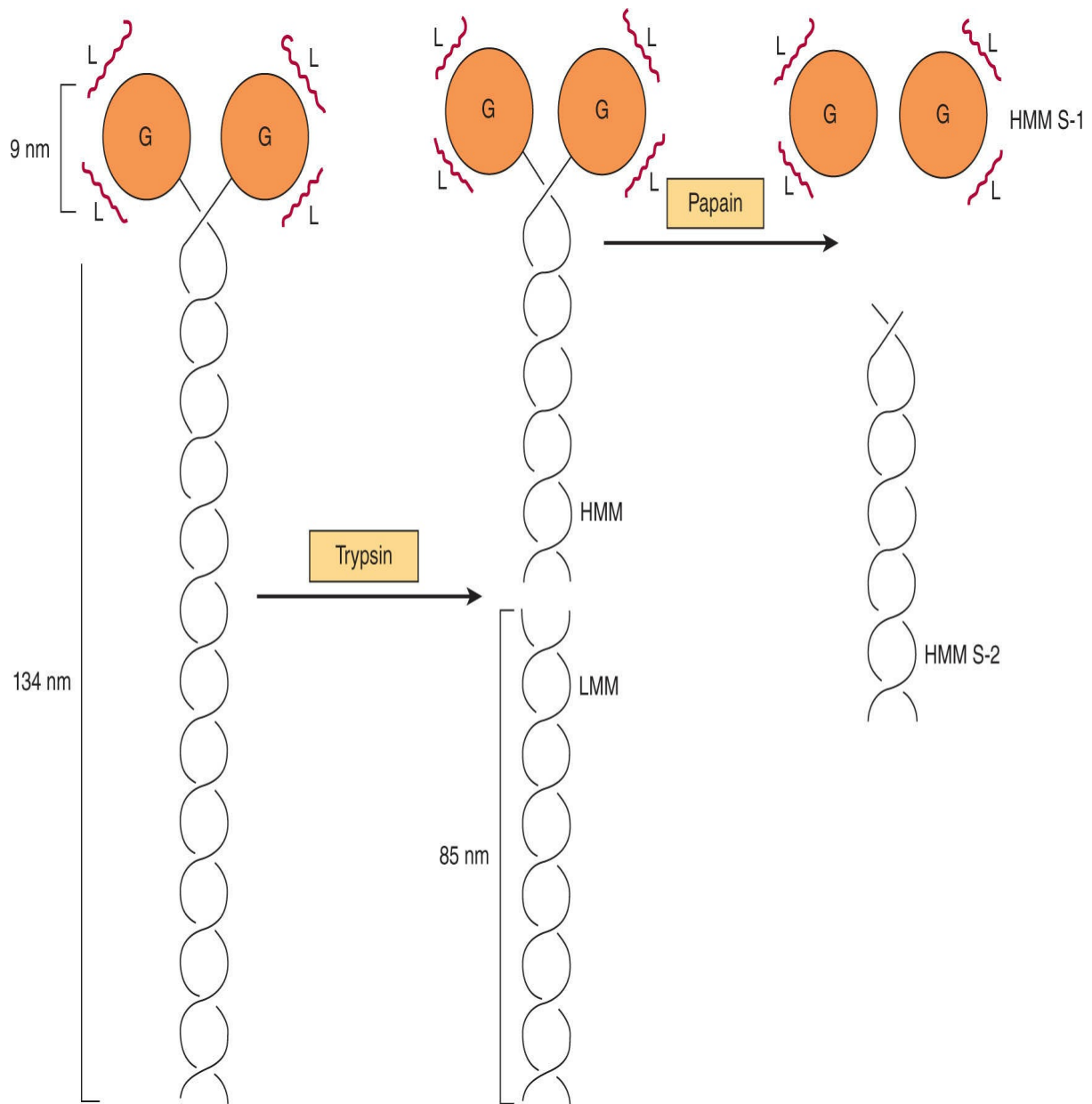

FIGURE 51–4 Diagram of a myosin molecule showing the two intertwined α -helices (fibrous portion), the globular region or head (G), the light chains (L), and the effects of proteolytic cleavage by trypsin and papain. The globular head region, which contains an actin-binding site and an L chain-binding site, attaches to the remainder of the myosin molecule.

The Structural & Functional Organization of Myosin Was Mapped by Limited Proteolysis

The tendency of myosin to polymerize under physiologic conditions frustrated attempts to map its domain organization. Therefore, researchers

turned to **limited proteolysis**, a technique wherein proteins are treated with small quantities of proteolytic enzymes for short periods. The objective of this method is to capture individual protein domains that have been liberated by the hydrolysis of the oftentimes highly susceptible peptide bonds present in the flexible “hinge” regions that link individual functional domains.

Limited proteolysis with **trypsin** yielded two myosin fragments called light and heavy **meromyosin** (HMM). Light meromyosin (LMM) consists of the aggregated α -helical fibers from the tail of myosin (Figure 51–4). It does not hydrolyze ATP or bind to F-actin. By contrast, HMM is a soluble \approx 340 kDa protein that possesses both fibrous and globular regions (Figure 51–4). HMM exhibits ATPase activity and binds to F-actin. Limited proteolysis of HMM with papain cleaves it into two subfragments, S-1 and S-2, that encompass the globular and fibrous regions, respectively. Only the globular **S-1** fragment, \approx 115 kDa, exhibits ATPase activity and binds both actin and myosin light chains (Figure 51–4).

Tropomyosin & the Troponins Are Key Components of the Thin Filaments in Striated Muscle

In striated muscle, there are two other proteins that are minor in terms of their mass but important in terms of their function. **Tropomyosin** is a fibrous molecule that consists of two chains, α and β , that attach to F-actin in the groove between its filaments (Figure 51–3). Tropomyosin is present in all muscular and muscle-like structures. The **troponin complex** is unique to striated muscle and consists of three polypeptides. **Troponin T** (TpT) binds to tropomyosin as well as to the other two troponin components. **Troponin I** (TpI) inhibits the F-actin–myosin interaction and also binds to the other components of troponin. **Troponin C** (TpC) is a calcium-binding polypeptide that is structurally and functionally analogous to **calmodulin**, an important calcium-binding protein widely distributed in nature. Up to four calcium ions can bind per molecule of troponin C or calmodulin, both of which have a molecular mass of \approx 17 kDa.

MUSCLE CONVERTS CHEMICAL ENERGY TO MECHANICAL ENERGY

Muscle contraction occurs when thick filaments translocate along adjacent thin filaments by a process analogous to climbing a rope hand over hand. The hands in this instance are the S-1 domains of the myosin head, which

ascend by via a repeated cycle of attachment, an ATP-powered conformational change or **power stroke**, and detachment. Although individually minute in terms of both distance covered and the energy unleashed, when multiplied by the $1\text{-}2 \times 10^{18}$ myosin molecules in a human bicep, both great force and rapid motion can be generated.

A schematic diagram of the cycle of events involved in each power stroke is presented in **Figure 51–5**.

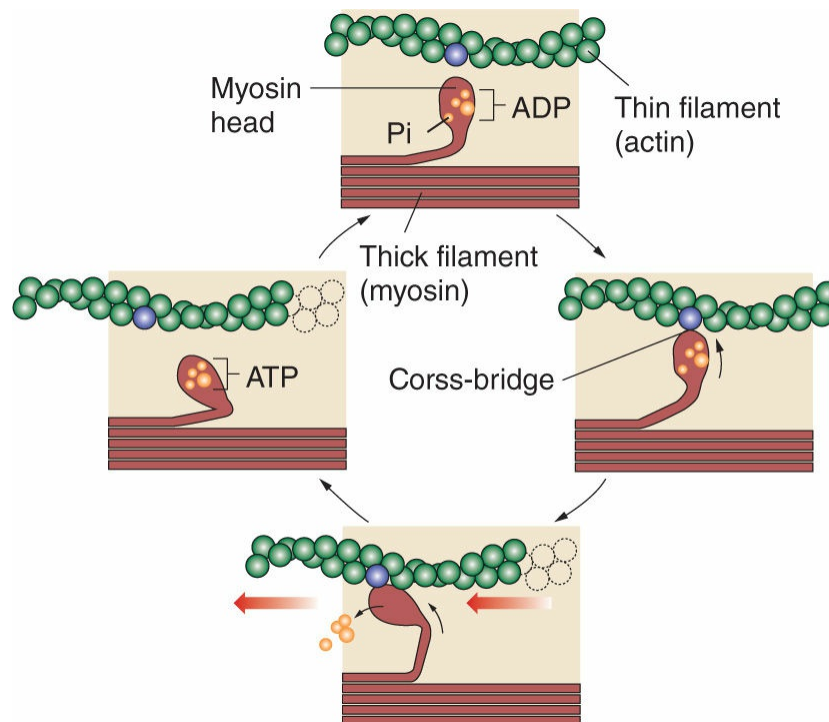

FIGURE 51–5 The hydrolysis of ATP drives the cyclic association and dissociation of actin and myosin in five reactions described in the text. (Reproduced with permission from McGraw-Hill Higher Education.)

At rest, the S-1 head of myosin contains bound ADP and P_i , remnants of the last prior power stroke. Upon stimulation by the second messenger Ca^{2+} (see below), actin becomes accessible to the S-1 head of myosin which finds it and binds it, thereby forming a **cross-bridge** linking the thick and thin filaments that are spaced at intervals of 14 nm along the thick filaments. As depicted in **Figure 51–2**, the clusters of cross-bridges (abbreviated as arrowheads with the remainder of the thin filaments not shown) at ends of a thick filament have opposite polarities. The two polar regions of the thick filament are separated by a 150-nm segment (the M band, not labeled in the figure) which does not participate in cross-bridge formation.

Once the actin:myosin:ADP:P_i cross-bridge complex is formed, the bound P_i is released. This is followed by release of the bound ADP, triggering a large conformational change in the head of myosin in relation to its tail (Figure 51–6), the power stroke, that pulls the actin about 10 nm toward the center of the sarcomere. This nucleotide-free actin-myosin complex represents its low-energy state.

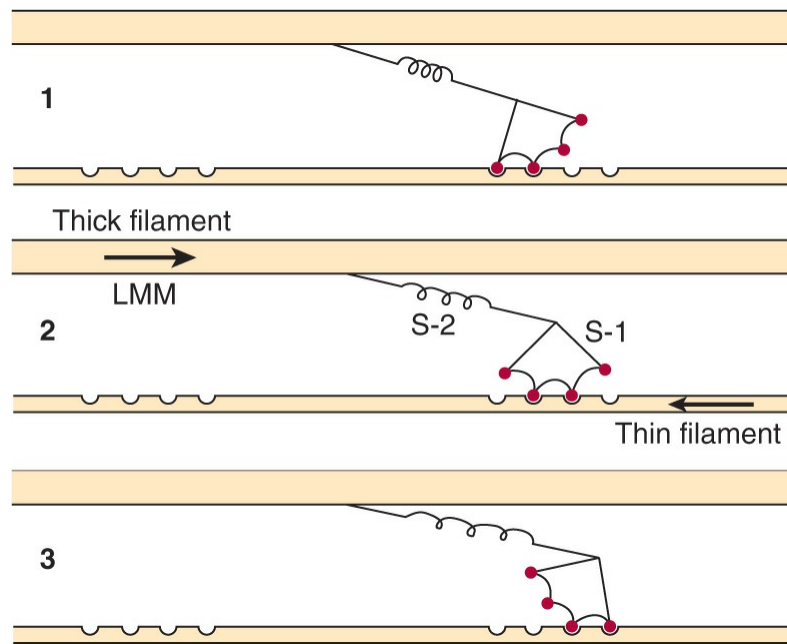

FIGURE 51–6 Representation of the active cross-bridges between thick and thin filaments. This diagram was adapted by AF Huxley from HE Huxley: the mechanism of muscular contraction. *Science* 1969;164:1356. The latter proposed that the force involved in muscular contraction originates in a tendency for the myosin head (S-1) to rotate relative to the thin filament and is transmitted to the thick filament by the S-2 portion of the myosin molecule acting as an inextensible link. Flexible points at each end of S-2 permit S-1 to rotate and allow for variations in the separation between filaments. This figure is based on HE Huxley’s proposal, and also incorporates elastic (the coils in the S-2 portion) and stepwise-shortening elements (depicted here as four sites of interaction between the S-1 portion and the thin filament). (See Huxley AF, Simmons RM: Proposed mechanism of force generation in striated muscle. *Nature [Lond]* 1971;233:533.) The strengths of binding of the attached sites are higher in position 2 than in position 1 and higher in position 3 than position 2. The myosin head can be detached from position 3 with the utilization of a molecule of ATP; this is the predominant process during shortening. The myosin head is seen to vary in its position from about 90°

to about 45°, as indicated in the text. (S-1, myosin head; S-2, portion of the myosin molecule; LMM, light meromyosin) (see legend to [Figure 49–4](#)). (Reproduced from Huxley AF: Muscular contraction. *J Physiol* 1974;243:1. By kind permission of the author and the *Journal of Physiology*.)

Next, a molecule of ATP binds to the S-1 head, which drastically lowers the affinity of the myosin head for actin. Actin is thus released, or detached. Finally, in the **relaxation phase** of muscle contraction, the S-1 head of myosin hydrolyzes ATP to ADP and P_i, but these products remain bound. The hydrolysis of ATP to ADP-P_i-myosin raises myosin into a so-called high-energy conformation. The myosin:ADP:P_i complex now stands ready to engage in another cycle and move another 10 nm along the thin filaments, provided Ca²⁺ levels remain elevated.

Calculations have indicated that the thermodynamic efficiency of muscle contraction is about 50%, which compares quite favorably to the 20% or less of the internal combustion engine. It should also be noted that, while hydrolysis of ATP ultimately powers the cycle, the release of ADP provides the immediate driver for the conformational change in S-1 that translates chemical energy into the mechanical power stroke. **Rigor mortis**, the stiffening of the body that occurs postmortem, occurs because the resulting fall in intracellular ATP levels prevents the dissociation of the myosin S-1 head from actin.

CONTRACTION IS ORCHESTRATED BY THE SECOND MESSENGER Ca²⁺

The contraction of muscles from all sources occurs by the general mechanism described above. However, the manner in which contraction is regulated differs among the various types of muscle tissue. Striated muscle relies on **actin-based** regulation, while regulation in smooth muscle is **myosin-based**. However, regardless of whether regulation is actin- or myosin-based, the second messenger Ca²⁺ plays a central role in the initiation and control of contraction.

Actin-Based Regulation Occurs in Skeletal Muscle

The contractile apparatus in skeletal muscle is regulated by the **troponin system**, which is bound to tropomyosin and F-actin in the thin filament

(Figure 51–3). Hence, regulation of skeletal muscle is said to be actin-based. In resting muscle, TpI prevents binding of the myosin head to its F-actin attachment site either by altering the conformation of F-actin via the tropomyosin molecules or by simply rolling tropomyosin into a position that directly blocks the sites on F-actin to which the myosin heads attach. Binding of Ca^{2+} to TpC relieves inhibition by TpI, permitting the power stroke cycle to proceed. When Ca^{2+} levels fall, the TpC: Ca^{2+} complex dissociates, allowing TpI to reestablish its inhibitory block on the binding of the myosin S-1 head to F-actin. The thick and thin filaments detach from one another, allowing the muscle to relax.

Myosin-Based Regulation Occurs in Smooth Muscle

Smooth muscles have molecular structures similar to those in striated muscle, but the sarcomeres are not aligned so as to generate the striated appearance. Smooth muscles contain α -actinin and tropomyosin molecules, as do skeletal muscles, but they lack the troponin system. The light chains of smooth muscle myosin molecules also differ from those of striated muscle myosin. In smooth muscle, it is the light chains that prevent the binding of the myosin head to F-actin in the resting state. This inhibitory block is released by the phosphorylation of the regulatory, or type 2, light chains in the myosin S-1 head by myosin light-chain kinase.

The activity of myosin light-chain kinase is controlled by the binding of the small, ≈ 17 kDa, Ca^{2+} -binding protein, calmodulin (Figure 51–7).

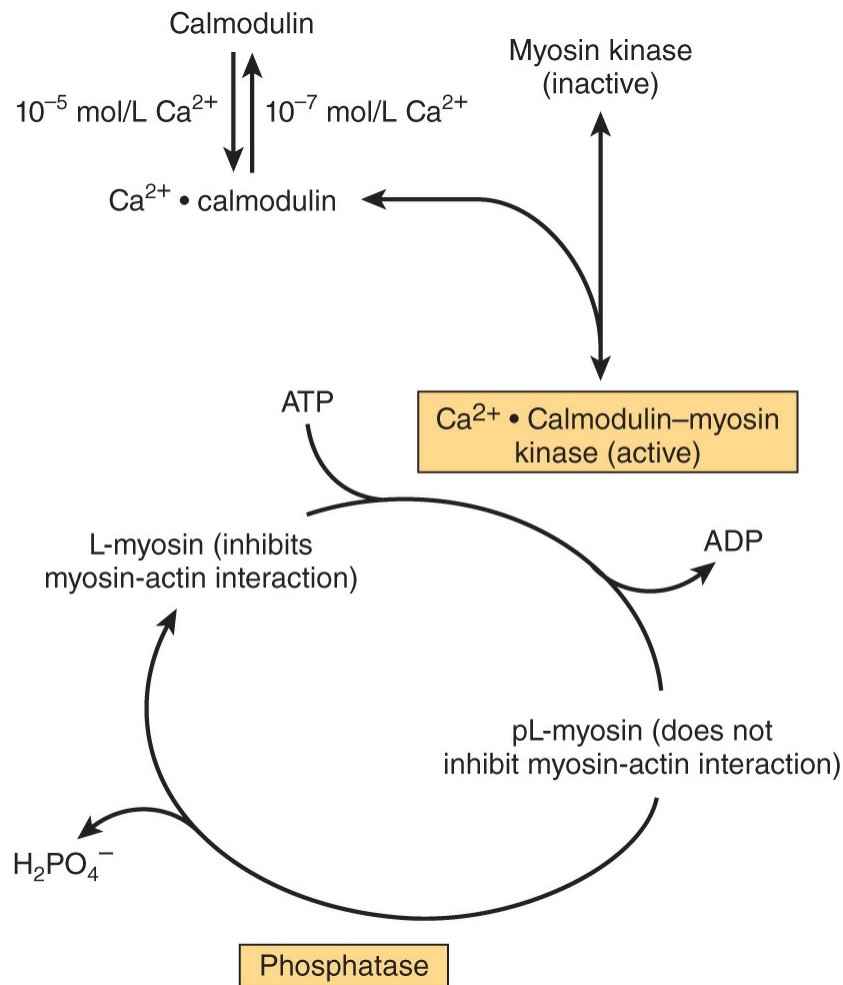

FIGURE 51–7 Regulation of smooth muscle contraction by Ca^{2+} . The pL-myosin is the phosphorylated light chain of myosin and L-myosin is the dephosphorylated light chain. (Adapted, with permission, from Adelstein RS, Eisenberg R: Regulation and kinetics of actin–myosin ATP interaction. *Annu Rev Biochem* 1980;49:921. Copyright © 1980 by Annual Reviews, www.annualreviews.org.)

Calmodulin is a ubiquitous protein that contains four EF-hand motifs, each of which can bind one molecule of calcium. Binding of calcium to all four of these sites triggers a conformational change that enables the Ca^{2+}_4 :calmodulin complex to bind to and activate various intracellular target enzymes, including myosin light-chain kinase and Ca^{2+} -ATPase (see below). Ca^{2+} binding to calmodulin exhibits strong positive cooperativity, optimizing it to serve as a Ca^{2+} -sensitive molecular trigger. When Ca^{2+} levels fall, the balance of activity between myosin light-chain kinases and phosphatases shifts in favor of the latter, leading to the dephosphorylation of regulatory light chains, the detachment of myosin S-

1 domains from actin, and muscle relaxation.

Rho kinase provides a Ca^{2+} -independent pathway for initiating contraction. Rho kinase not only phosphorylates myosin's regulatory light chains, it also phosphorylates the phosphatase that dephosphorylates them. Since phosphorylation of the phosphatase inhibits its activity, this serves to further shift the balance between the kinases and phosphatases that act on myosin in favor of the former. **Table 51–1** summarizes and compares the regulation of actin-myosin interactions (activation of myosin ATPase) in striated and smooth muscles. Phosphorylation of Rho kinase by the cAMP-dependent protein kinase may play a role in the dampening effect of this second messenger on smooth muscle contraction.

TABLE 51–1 Actin-Myosin Interactions in Striated and Smooth Muscle

	Striated Muscle	Smooth Muscle (and Nonmuscle Cells)
Proteins of muscle filaments	Actin Myosin Tropomyosin Troponin (T _{pl} , T _{pT} , T _{pC})	Actin Myosin ^a Tropomyosin
Spontaneous interaction of F-actin and myosin alone (spontaneous activation of myosin ATPase by F-actin)	Yes	No
Inhibitor of F-actin–myosin interaction (inhibitor of F-actin-dependent activation of ATPase)	Troponin system (T _{pl})	Unphosphorylated myosin light chain
Contraction activated by	Ca^{2+}	Ca^{2+}
Direct effect of Ca^{2+}	4Ca^{2+} bind to T _{pC}	4Ca^{2+} bind to calmodulin
Effect of protein-bound Ca^{2+}	T _{pC} · 4Ca^{2+} antagonizes T _{pl} inhibition of F-actin–myosin interaction (allows F-actin activation of ATPase)	Calmodulin · 4Ca^{2+} activates myosin light-chain kinase that phosphorylates myosin p-light chain. The phosphorylated p-light chain no longer inhibits F-actin–myosin interaction (allows F-actin activation of ATPase)

Another protein that appears to play a Ca^{2+} -dependent role in the regulation of smooth muscle contraction is **caldesmon** (87 kDa). This protein is ubiquitous in smooth muscle and is also found in nonmuscle tissue. At low concentrations of Ca^{2+} , it binds to tropomyosin and actin. This prevents the interaction of actin with myosin, keeping muscle in a relaxed state. At higher concentrations of Ca^{2+} :calmodulin binds

caldesmon, releasing it from actin. The latter is then free to bind to myosin, and contraction can occur. Caldesmon is also subject to phosphorylation-dephosphorylation; when phosphorylated, it cannot bind actin, again freeing the latter to interact with myosin.

The Sarcoplasmic Reticulum Regulates Intracellular Levels of Ca^{2+} in Skeletal Muscle

When striated muscle is in the relaxed state, the Ca^{2+} needed to initiate contraction is kept stored, ready for release into the sarcoplasm, within a network of fibrous membrane sacks—the **sarcoplasmic reticulum** or **SR**. The SR is linked to the sarcomeres by the transverse channels of the T-tubule system. In resting muscle, the concentration of Ca^{2+} in the sarcoplasm typically ranges between 10^{-8} and 10^{-7} mol/L. This low resting concentration is maintained by the basal activity of the Ca^{2+} ATPase (**Figure 51–8**), a Ca^{2+} -activated calcium pump that uses the energy of hydrolysis of ATP to move calcium ions from regions of low to high concentration. Once inside the SR, Ca^{2+} is bound to a specific Ca^{2+} -binding protein-designated **calsequestrin**.

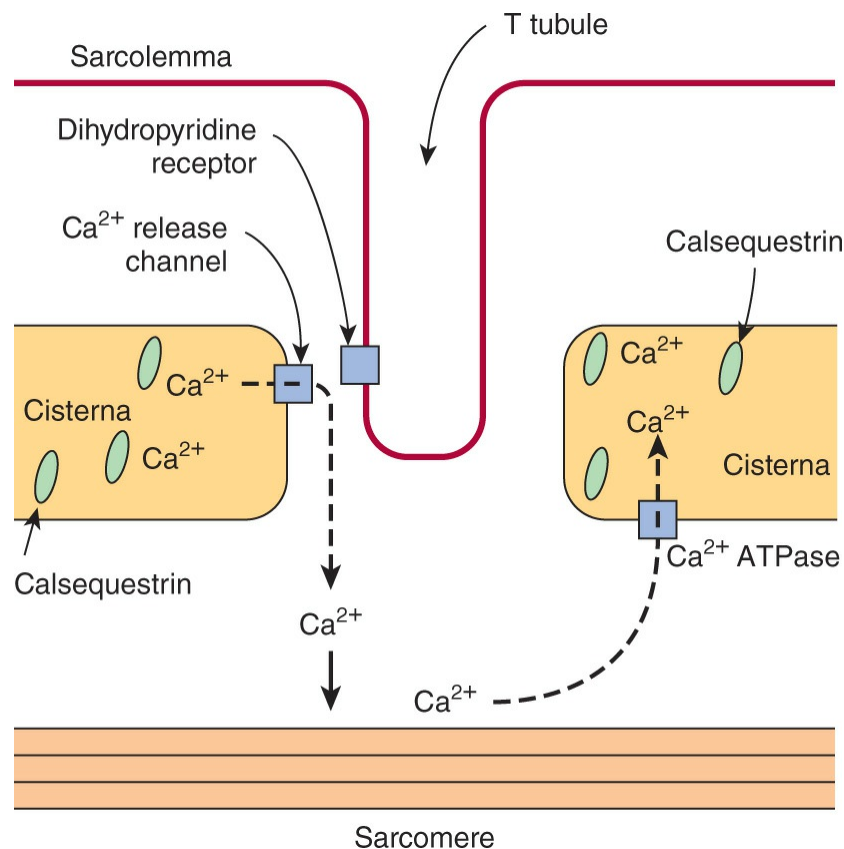

FIGURE 51–8 Diagram of the relationships among the sarcolemma (plasma membrane), a T tubule, and two cisternae of the SR of skeletal muscle (not to scale). The T tubule extends inward from the sarcolemma. A wave of depolarization, initiated by a nerve impulse, is transmitted from the sarcolemma down the T tubule. It is then conveyed to the Ca^{2+} release channel (RyR), perhaps by interaction between it and the dihydropyridine receptor (slow Ca^{2+} voltage channel), which are shown in close proximity. Release of Ca^{2+} from the Ca^{2+} release channel into the cytosol initiates contraction. Subsequently, Ca^{2+} is pumped back into the cisternae of the SR by the Ca^{2+} ATPase (Ca^{2+} pump) and stored there, in part bound to calsequestrin.

When the sarcolemma is excited by a **nerve impulse**, the excitable membranes of the T-tubule system become depolarized, opening the **voltage-gated** Ca^{2+} release channels in the nearby SR. Ca^{2+} rapidly floods into the sarcoplasm, raising the concentration nearly 100-fold, to 10^{-5} mol/L, where it binds to troponin C and calmodulin to initiate contraction. The voltage-gated Ca^{2+} release channel, a homotetramer of ≈ 565 kDa subunits, is the target of the plant alkaloid **ryanodine**, which binds to it and modulates its activity. Hence, the voltage-gated Ca^{2+} channel is also referred to as the ryanodine receptor, or RyR. There are two isoforms of this receptor. RyR1 is present in skeletal muscle. RyR2 is present heart muscle and brain. The channel lies very close to another voltage-gated Ca^{2+} channel of the transverse tubule system, the **dihydropyridine receptor** (Figure 51–8).

The release of Ca^{2+} into the sarcoplasm also activates the Ca^{2+} -dependent ATPase, whose activity is stimulated by the binding of Ca^{2+}_4 :calmodulin. This immediately sets into motion the export of Ca^{2+} from the sarcoplasm back into the SR, enabling the muscle to rapidly relax and ready for another contraction. If the concentration of ATP in the sarcoplasm falls dramatically (eg, by excessive usage during the cycle of contraction-relaxation or by diminished formation, such as might occur in ischemia), the Ca^{2+} -ATPase will cease pumping and calcium ion levels will remain high.

Mutations in the Gene Encoding the Ca^{2+} Release Channel Are Cause of Human Malignant

Hyperthermia

Some genetically predisposed patients experience a severe reaction, designated **malignant hyperthermia (MH)**, on exposure to certain anesthetics (eg, halothane) and depolarizing skeletal muscle relaxants (eg, succinylcholine). The reaction consists primarily of rigidity of skeletal muscles, hypermetabolism, and high fever. A **high cytosolic concentration of Ca^{2+}** in skeletal muscle is a major factor in its causation. Unless malignant hyperthermia is recognized and treated immediately, patients may die acutely of ventricular fibrillation or succumb to other serious complications. Appropriate treatment is to stop the anesthetic and administer the drug **dantrolene**, a skeletal muscle relaxant that acts to inhibit release of Ca^{2+} from the SR into the cytosol, intravenously. MH also occurs in **swine** homozygous for MH (**porcine stress syndrome**). If the reaction occurs prior to slaughter, it affects the quality of the pork adversely, resulting in an inferior product.

The causes of MH in humans and livestock appear to be complex, and may involve mutations in the genes encoding the Ca^{2+} release channel, calsequestrin-1, or the dihydropyridine receptor or in the *RYR1* gene. Mutations in the *RYR1* gene are also associated with **central core disease**. This is a rare myopathy presenting in infancy with hypotonia and proximal muscle weakness. Electron microscopy reveals an absence of mitochondria in the center of many type I muscle fibers. Damage to mitochondria induced by high intracellular levels of Ca^{2+} secondary to abnormal functioning of *RYR1* appears to be responsible for the morphologic findings.

CARDIAC MUSCLE RESEMBLES SKELETAL MUSCLE IN MANY RESPECTS

Regulation of Contraction in Cardiac Muscle Is Also Actin-Based

Cardiac muscle, like skeletal muscle, is **striated** and is regulated by the same actin-myosin-tropomyosin-troponin system. Unlike skeletal muscle, cardiac muscle exhibits **intrinsic rhythmicity**, and individual myocytes communicate with each other because of its syncytial nature. The **T-tubular system** (see below) is more developed in cardiac muscle, whereas the SR is less extensive and consequently the intracellular supply of Ca^{2+}

for contraction is lower. Cardiac muscle thus relies on **extracellular Ca^{2+}** for contraction; if isolated cardiac muscle is deprived of Ca^{2+} , it ceases to beat within approximately 1 minute, whereas skeletal muscle can continue to contract without an extracellular source of Ca^{2+} for a longer period. **Cyclic AMP** plays a more prominent role in cardiac than in skeletal muscle. It modulates intracellular levels of Ca^{2+} through the activation of the protein kinases that phosphorylate various transport proteins in the sarcolemma and SR. They also target the troponin-tropomyosin regulatory complex, affecting its responsiveness to intracellular Ca^{2+} . There is a rough correlation between the phosphorylation of TpI and the increased contraction of cardiac muscle induced by catecholamines. This may account for the **inotropic effects** (increased contractility) of β -adrenergic compounds on the heart. Some differences among skeletal, cardiac, and smooth muscle are summarized in **Table 51–2**.

TABLE 51–2 Some Differences Among Skeletal, Cardiac, and Smooth Muscle

Skeletal Muscle	Cardiac Muscle	Smooth Muscle
1. Striated	1. Striated	1. Nonstriated
2. No syncytium	2. Syncytial	2. Syncytial
3. Small T tubules	3. Large T tubules	3. Generally rudimentary T tubules
4. Sarcoplasmic reticulum well developed and Ca^{2+} pump acts rapidly.	4. Sarcoplasmic reticulum present and Ca^{2+} pump acts relatively rapidly.	4. Sarcoplasmic reticulum often rudimentary and Ca^{2+} pump acts slowly.
5. Plasmalemma contains few hormone receptors.	5. Plasmalemma contains a variety of receptors (eg, α - and β -adrenergic).	5. Plasmalemma contains a variety of receptors (eg, α - and β -adrenergic).
6. Nerve impulse initiates contraction.	6. Has intrinsic rhythmicity.	6. Contraction initiated by nerve impulses, hormones, etc.
7. Extracellular fluid Ca^{2+} not important for contraction.	7. Extracellular fluid Ca^{2+} important for contraction.	7. Extracellular fluid Ca^{2+} important for contraction.
8. Troponin system present.	8. Troponin system present.	8. Lacks troponin system; uses regulatory head of myosin.
9. Caldesmon not involved.	9. Caldesmon not involved.	9. Caldesmon is important regulatory protein.
10. Very rapid cycling of the cross-bridges.	10. Relatively rapid cycling of the cross-bridges.	10. Slow cycling of the cross-bridges permits slow, prolonged contraction and less utilization of ATP.

Ca^{2+} Enters Cardiomyocytes via Ca^{2+} Channels &

Leaves via the Na^+ - Ca^{2+} Exchanger & the Ca^{2+} ATPase

Extracellular Ca^{2+} enters cardiomyocytes via highly selective channels. The major portal of entry is the L-type (long-duration current, large conductance) or **slow Ca^{2+}** channel, which is voltage-gated, opening during depolarization and closing when the action potential declines. These channels are equivalent to the dihydropyridine receptors of skeletal muscle (Figure 51–8). Slow Ca^{2+} channels are **regulated** by cAMP-dependent protein kinases (stimulatory) and cGMP-dependent protein kinases (inhibitory), and can be inhibited by so-called calcium channel blockers (eg, verapamil). **Fast** (or T, transient) Ca^{2+} channels are also present in the plasmalemma, though in much lower numbers; they probably contribute to the early phase of increase of myoplasmic Ca^{2+} .

When the concentration of Ca^{2+} in the myoplasm increases, it triggers the opening of the Ca^{2+} release channel of the SR. In fact, Ca^{2+} -induced Ca^{2+} release from the SR stores accounts for approximately 90% of the Ca^{2+} that enters a stimulated cardiomyocyte. However, the 10% that enters from the cytoplasm is vitally important, as it serves as a trigger for mobilization of Ca^{2+} from the SR.

The Na^+ - Ca^{2+} exchanger serves as the principal route of egress of Ca^{2+} from cardiomyocytes. Na^+ and Ca^{2+} are exchanged at a ratio of 3:1, with movement of sodium ions into the cell from the plasma providing the energy needed to move calcium into the plasma against a concentration gradient. This exchange contributes to relaxation, but may run in the reverse direction during excitation. Consequently, anything that causes intracellular Na^+ to rise will secondarily cause intracellular Ca^{2+} to rise as well, causing more forceful contraction (**positive inotropic effect**).

Digitalis promotes the inflow of Ca^{2+} via the Ca^{2+} - Na^+ exchanger by inhibiting the sarcolemmal Na^+ - K^+ -ATPase, reducing the rate of Na^+ exit by this route, thereby increasing intracellular Na^+ . The resulting increase in intracellular Ca^{2+} enhances the force of cardiac contraction to the benefit of a patient experiencing heart failure (Figure 51–9).

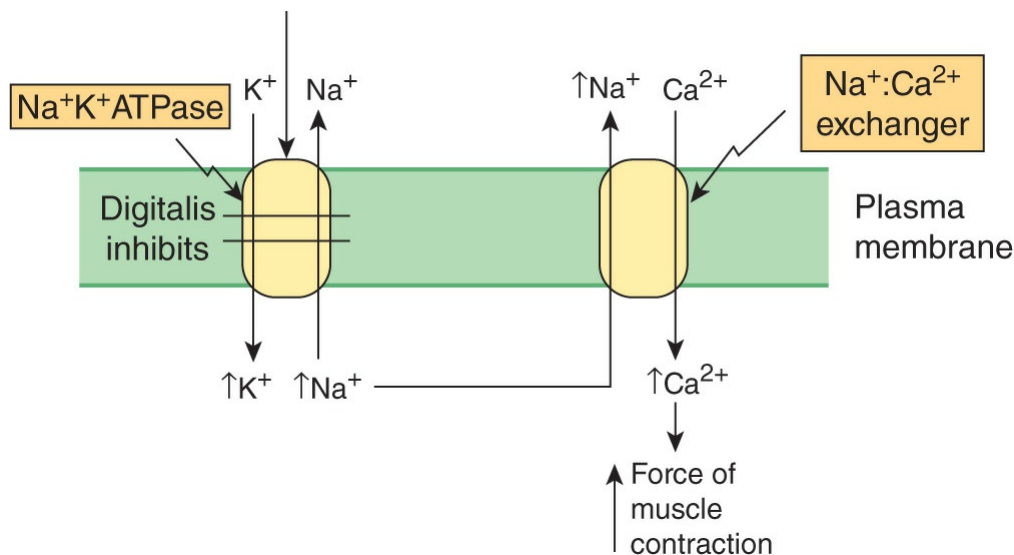

FIGURE 51–9 Scheme of how the drug digitalis (used in the treatment of certain cases of heart failure) increases cardiac contraction. Digitalis inhibits the Na⁺-K⁺ ATPase (see Chapter 40). This results in less Na⁺ being pumped out of the cardiac myocyte and leads to an increase of the intracellular concentration of Na⁺. In turn, this stimulates the Na⁺-Ca²⁺ exchanger so that more Na⁺ is exchanged outward, and more Ca²⁺ enters the myocyte. The resulting increased intracellular concentration of Ca²⁺ increases the force of muscular contraction.

In contrast to skeletal muscle, the sarcolemmal Ca²⁺ ATPase is believed to be a minor contributor to Ca²⁺ egress as compared with the Ca²⁺-Na⁺ exchanger. Cardiac muscle is rich in ion channels (see Chapter 40), and they are also important in skeletal muscle. Mutations in genes encoding ion channels have been shown to be responsible for a number of relatively rare conditions affecting muscle. These and other diseases due to mutations of ion channels have been termed channelopathies; some are listed in Table 51–3.

TABLE 51–3 Some Disorders (Channelopathies) due to Mutations in Genes Encoding Polypeptide Constituents of Ion Channels

Disorder ^a	Ion Channel and Major Organs Involved
Central core disease (OMIM 117000)	Ca ²⁺ release channel (RYR1), skeletal muscle
Hyperkalemic periodic paralysis (OMIM 170500)	Sodium channel, skeletal muscle
Hypokalemic periodic paralysis (OMIM 170400)	Slow Ca ²⁺ voltage channel (DHPR), skeletal muscle
Malignant hyperthermia (OMIM 145600)	Ca ²⁺ release channel (RYR1), skeletal muscle
Myotonia congenita (OMIM 160800)	Chloride channel, skeletal muscle

MUSCLE CONTRACTION REQUIRES LARGE QUANTITIES OF ATP

The amount of ATP in skeletal muscle is only sufficient to provide energy for contraction for a few seconds. Consequently, muscle cells have developed multiple mechanisms to regenerate the ATP needed to sustain the contraction-relaxation cycle: (1) by glycolysis, using blood glucose or muscle glycogen, (2) by oxidative phosphorylation, (3) from creatine phosphate, and (4) from two molecules of ADP in a reaction catalyzed by adenylyl kinase (**Figure 51–10**).

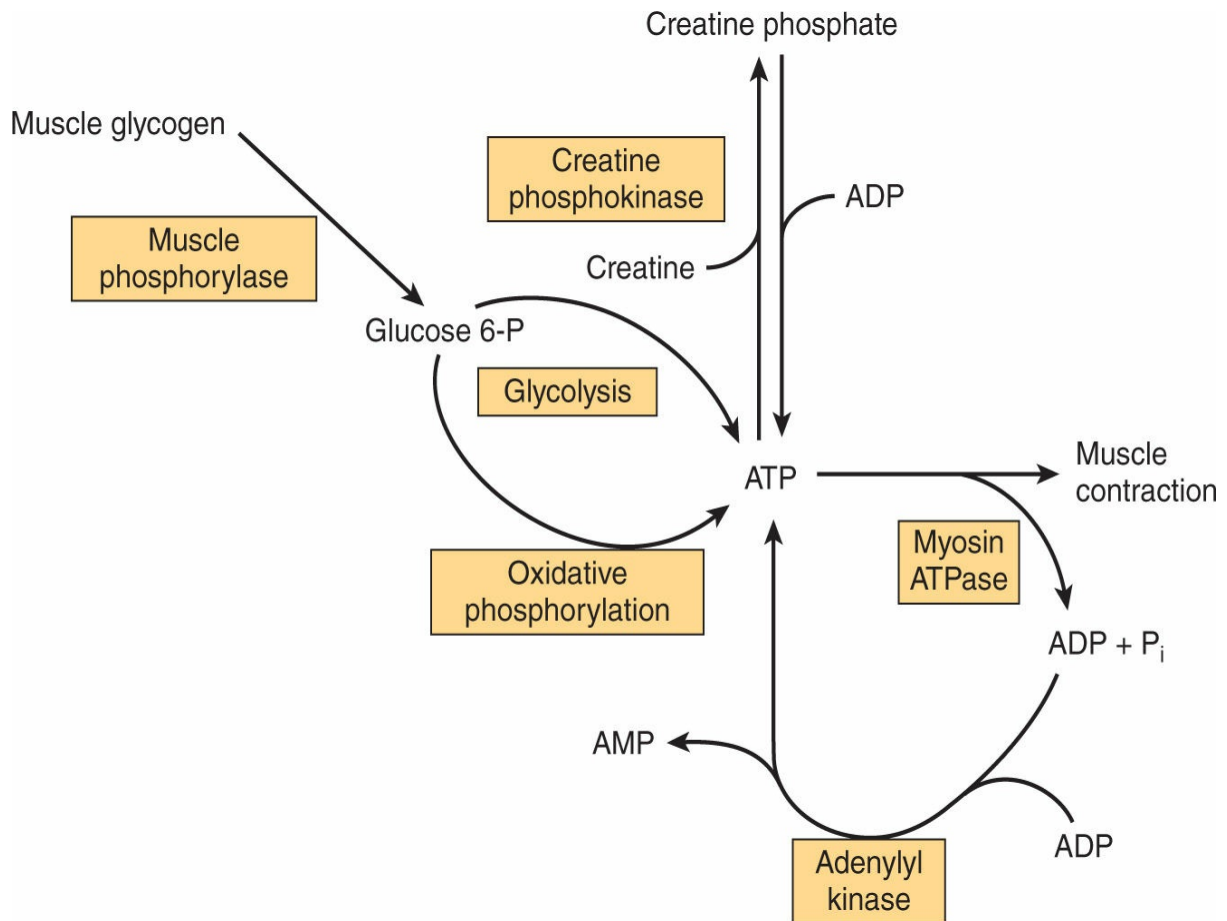

FIGURE 51–10 The multiple sources of ATP in muscle.

Skeletal Muscle Contains Large Quantities of Glycogen

The sarcoplasm of skeletal muscle contains large stores of **glycogen**, located in granules close to the I bands. The release of glucose from glycogen is dependent on a specific muscle **glycogen phosphorylase** (see [Chapter 18](#)), which can be activated by Ca^{2+} , epinephrine, and AMP. Ca^{2+} also activates phosphorylase b kinase, allowing glucose mobilization to begin with the initiation of muscle contraction.

Under Aerobic Conditions, Muscle Generates ATP Mainly by Oxidative Phosphorylation

Synthesis of ATP via oxidative phosphorylation requires a supply of oxygen. Muscles that have a high demand for oxygen as a result of sustained contraction (eg, to maintain posture) store it attached to the heme moiety of myoglobin. Muscles containing myoglobin are red in color,

whereas muscles with little or no myoglobin are white. Glucose, derived from the blood glucose or from endogenous glycogen, and fatty acids, derived from the triacylglycerols of adipose tissue, are the principal substrates used for aerobic metabolism in muscle.

Creatine Phosphate Constitutes a Major Energy Reserve in Muscle

Creatine phosphate provides a readily available source high-energy phosphate that can be used to regenerate ATP from ADP. Creatine phosphate is synthesized by **creatine kinase** (CK), a muscle-specific enzyme with clinical utility in the detection of acute or chronic diseases of muscle, using ATP as the phosphodonor (Figure 51–10). The equilibrium constant for this reaction is near 1. Hence, when ATP levels are high, formation of creatine phosphate is favored. However, when ATP levels drop, the equilibrium shifts in favor of synthesizing ATP at the expense of stored creatine phosphate.

Adenylyl Kinase Serves as a Reserve of Last Resort

ATP synthase (see Figure 13–8) is the primary vehicle for regenerating ATP in living cells. However, it can only synthesize ATP from ADP. In order to regenerate ATP from AMP, the latter must first be phosphorylated to form ADP, a process catalyzed by the enzyme adenylyl kinase using ATP as phosphodonor. This enzyme thus can generate two molecules of ADP from one molecule each of AMP and ATP. When other means for regenerating ATP become exhausted and nucleotide triphosphate level plummet, the equilibrium shifts in favor of synthesizing ATP at the expense of ADP. It is important to note that the by-product of this reaction is AMP. Hence, this is only a temporary expedient as the cell can only cannibalize their total adenine nucleotide pool for so long.

SKELETAL MUSCLE CONTAINS SLOW (RED) & FAST (WHITE) TWITCH FIBERS

Different types of fibers have been detected in skeletal muscle. One classification subdivides them into type I (slow twitch), type IIA (fast twitch-oxidative), and type IIB (fast twitch-glycolytic). For the sake of simplicity, we shall consider only two types: type I (slow twitch, oxidative) and type II (fast twitch, glycolytic). The **type I** fibers are red

because they contain myoglobin and mitochondria; their metabolism is aerobic, and they maintain relatively sustained contractions. The white **type II** fibers lack myoglobin and contain few mitochondria: they derive their energy from anaerobic glycolysis and perform contractions of relatively short duration.

The proportion of these two types of fibers varies among the muscles of the body, depending on function and training. For example, the number of type I fibers in certain leg muscles increases in athletes training for marathons, whereas the number of type II fibers increases in sprinters. Type I fibers rely heavily on aerobic metabolism to regenerate ATP, while type II fibers rely on oxygen-independent sources such as creatine phosphate. For this reason, many endurance athletes will engage in carbohydrate loading, the ingestion of meals that predominantly consist of foods with a high starch content, in an effort to increase the size of their glycogen stores, while some sprinters will attempt to increase the pool of creatine phosphate in their muscles by ingesting creatine as a dietary supplement.

MUSCLE TISSUES ARE THE TARGET OF SEVERAL GENETIC DISORDERS

Inherited Cardiomyopathies Can Arise from Disorders of Cardiac Energy Metabolism or Abnormal Myocardial Proteins

A **cardiomyopathy** is any structural or functional abnormality of the ventricular myocardium. These abnormalities can arise from a number of causes, many of them hereditary. As shown in **Table 51–4**, the causes of inherited cardiomyopathies fall into two broad classes: (1) disorders of cardiac energy metabolism, mainly reflecting mutations in genes encoding enzymes or proteins involved in fatty acid oxidation (a major source of energy for the myocardium) and oxidative phosphorylation; (2) mutations in genes encoding proteins involved in or affecting myocardial contraction, such as myosin, tropomyosin, the troponins, and cardiac myosin-binding protein C.

TABLE 51–4 Biochemical Causes of Inherited Cardiomyopathies^a

Cause	Proteins or Process Affected
Inborn errors of fatty acid oxidation	Carnitine entry into cells and mitochondria Certain enzymes of fatty acid oxidation
Disorders of mitochondrial oxidative phosphorylation	Proteins encoded by mitochondrial genes Proteins encoded by nuclear genes
Abnormalities of myocardial contractile and structural proteins	β -Myosin heavy chains, troponin, tropomyosin, dystrophin

Mutations in the Cardiac β -Myosin Heavy-Chain Gene Are One Cause of Familial Hypertrophic Cardiomyopathy

Familial hypertrophic cardiomyopathy is one of the most commonly encountered hereditary cardiac diseases. Patients exhibit hypertrophy—often massive—of one or both ventricles, starting early in life. Most cases are transmitted in an autosomal dominant manner; the rest are sporadic. The root cause of this condition is any one of several **missense mutations** in the gene encoding the **β -myosin heavy chain** that leads to the replacement of a highly conserved amino acid with some other residue. The substitutions cluster in the head and head-rod regions of the myosin heavy chain. One hypothesis is that the mutant polypeptides (“poison polypeptides”) cause formation of abnormal myofibrils, eventually resulting in compensatory hypertrophy.

Patients with familial hypertrophic cardiomyopathy can show great variation in clinical picture. This in part reflects genetic heterogeneity as it appears that mutations in a number of other genes (eg, those encoding cardiac actin, tropomyosin, cardiac troponins I and T, essential and regulatory myosin light chains, cardiac myosin-binding protein C, titin, and mitochondrial tRNA-glycine and tRNA-isoleucine) may also cause familial hypertrophic cardiomyopathy. Patients harboring mutations that are predicted to alter the charge character of the affected amino acid side chain exhibit a significantly shorter life expectancy than patients in whom the mutation produced no alteration in charge.

Mutations in the genes encoding dystrophin, muscle LIM protein (so called because it was found to contain a cysteine-rich domain originally detected in three proteins: Lin-II, Isl-1, and Mec-3), the cyclic AMP response-element binding protein (CREB), desmin, and lamin have each been implicated in the causation of **dilated cardiomyopathy**. The first two proteins help organize the contractile apparatus of cardiac muscle cells, while CREB regulates the expression of several genes within these cells.

Mutations in the Gene Encoding Dystrophin Cause Duchenne Muscular Dystrophy

Other protein components of the contractile apparatus include titin, the world's largest known protein whose role is to anchor the ends of myofibrils, nebulin, α -actinin, desmin, and dystrophin. Among these proteins, **dystrophin** is of particular biomedical interest. Mutations in the gene that encodes it play a causative role in **Duchenne muscular dystrophy** and **Becker muscular dystrophy** and have been implicated in **dilated cardiomyopathy** (see below). Dystrophin bridges the actin cytoskeleton to the extracellular matrix at the interior face of the plasma membrane. Formation of this link is necessary for assembly of the synaptic junction. Duchenne muscular dystrophy appears to result from the inability of mutationally altered forms of dystrophin to support formation of functionally competent synaptic junctions. Similarly, mutations in genes encoding the glycosyltransferases that modify **α -dystroglycan** or those encoding polypeptide components of the **sarcoglycan** complex (**Figure 51-11**) are responsible for certain other congenital forms of muscular dystrophy such as **limb-girdle**.

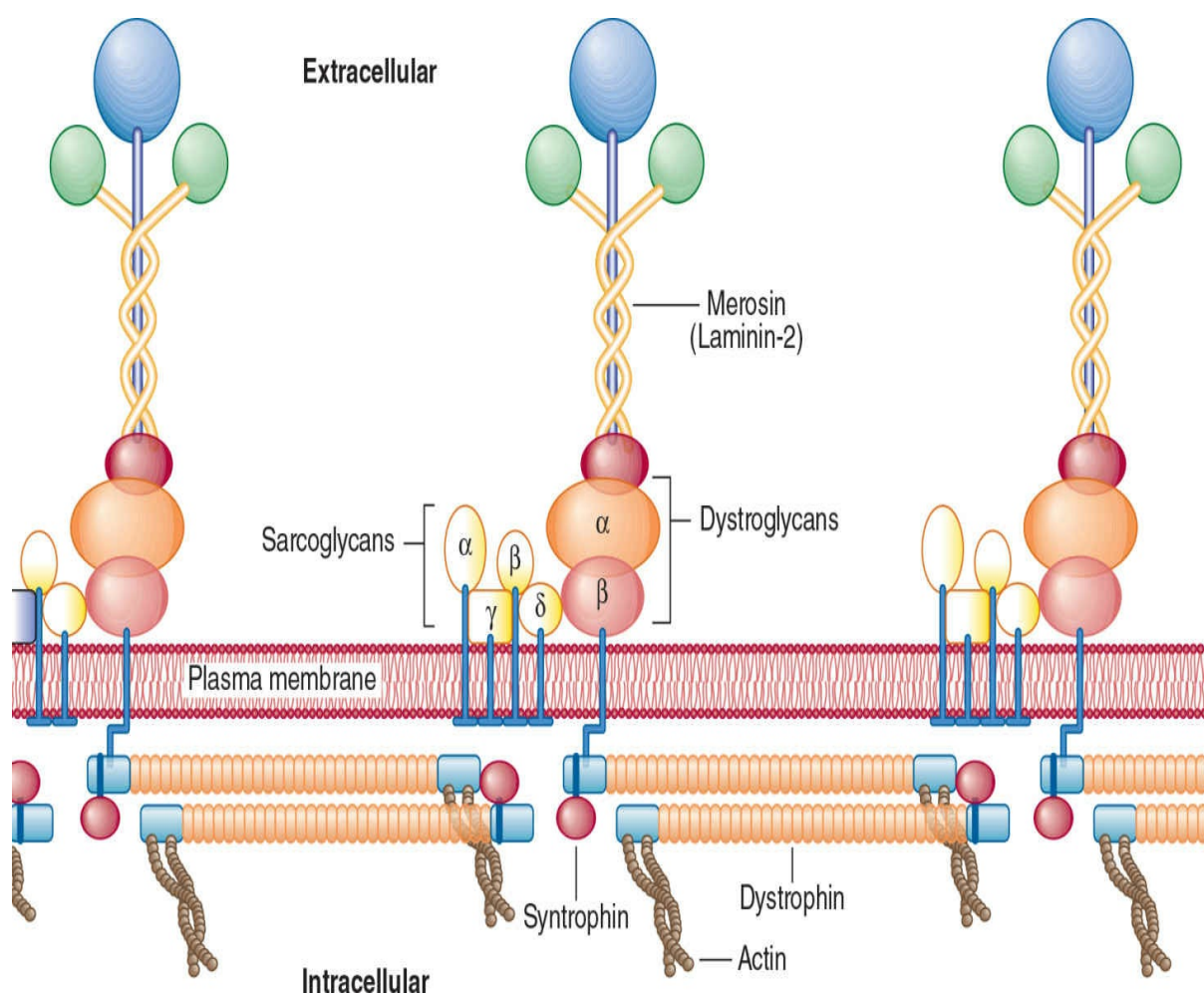

FIGURE 51–11 Organization of dystrophin and other proteins in relation to the plasma membrane of muscle cells. Dystrophin is part of a large oligomeric complex associated with several other protein complexes. The dystroglycan complex consists of α -dystroglycan, which associates with the basal lamina protein merosin (also named laminin-2, see [Chapter 50](#)), and α -dystroglycan, which binds α -dystroglycan and dystrophin. Syntrophin binds to the carboxyl terminal of dystrophin. The sarcoglycan complex consists of four transmembrane proteins: α -, β -, γ -, and δ -sarcoglycan. The function of the sarcoglycan complex and the nature of the interactions within the complex and between it and the other complexes are not clear. The sarcoglycan complex is formed only in striated muscle, and its subunits preferentially associate with each other, suggesting that the complex may function as a single unit. Mutations in the gene encoding dystrophin cause Duchenne and Becker muscular dystrophies. Mutations in the genes encoding the various sarcoglycans have been shown to be responsible for limb-girdle dystrophies (eg, OMIM 604286) and mutations in genes encoding other muscle proteins cause other types of muscular dystrophy. Mutations in genes encoding certain

glycosyltransferases involved in the synthesis of the glycan chains of α -dystroglycan are responsible for certain congenital muscular dystrophies. (Reproduced, with permission, from Duggan DJ et al: Mutations in the sarcoglycan genes in patients with myopathy. N Engl J Med 1997;336:618. Copyright © 1997 Massachusetts Medical Society. All rights reserved.)

Nitric Oxide (NO) Relaxes the Smooth Muscle of Blood Vessels

Acetylcholine triggers the relaxation of the smooth muscle of blood vessels via a receptor-mediated signal transduction pathway. Binding of acetylcholine to its cell surface receptors on the endothelial cells surrounding vascular smooth muscle cells activates associated phospholipases on the interior surface of the plasma membrane. These enzymes hydrolyze and release the polyphosphorylated head groups, particularly 3,4,5-triphosphoinositol, from phosphatidylinositol, a quantitatively minor but functionally important phospholipid component of the plasma membrane. These polyphosphoinositol second messengers initiate the release of Ca^{2+} into the cytoplasm of these vascular epithelial cells, which in turn triggers the release of **endothelium-derived relaxing factor (EDRF)**, which diffuses into the adjacent smooth muscle.

The identification of EDRF as **NO, nitrous oxide**, proved very difficult, because this diatomic gas rapidly reacts with oxygen and superoxide, resulting in a very short half-life (~ 3-4 seconds) in tissues.

NO is formed by NO synthase, a Ca^{2+} -activated enzyme found in the cytosol. NO synthase catalyzes the five-electron oxidation of an guanidino nitrogen in the side chain of arginine, yielding citrulline and NO (**Figure 51-12**), a complex reaction that utilizes NADPH and four redox-active prosthetic groups: FAD, FMN, heme, and tetrahydrobiopterin. Upon diffusing into the surrounding vascular smooth muscle cells, NO binds to the heme moiety of a soluble guanylyl cyclase, activating the enzyme and elevating the intracellular levels of the second messenger 3',5'-cyclic GMP (cGMP). This in turn stimulates the activities of certain cGMP-dependent protein kinases, which probably phosphorylate specific muscle proteins, causing relaxation.

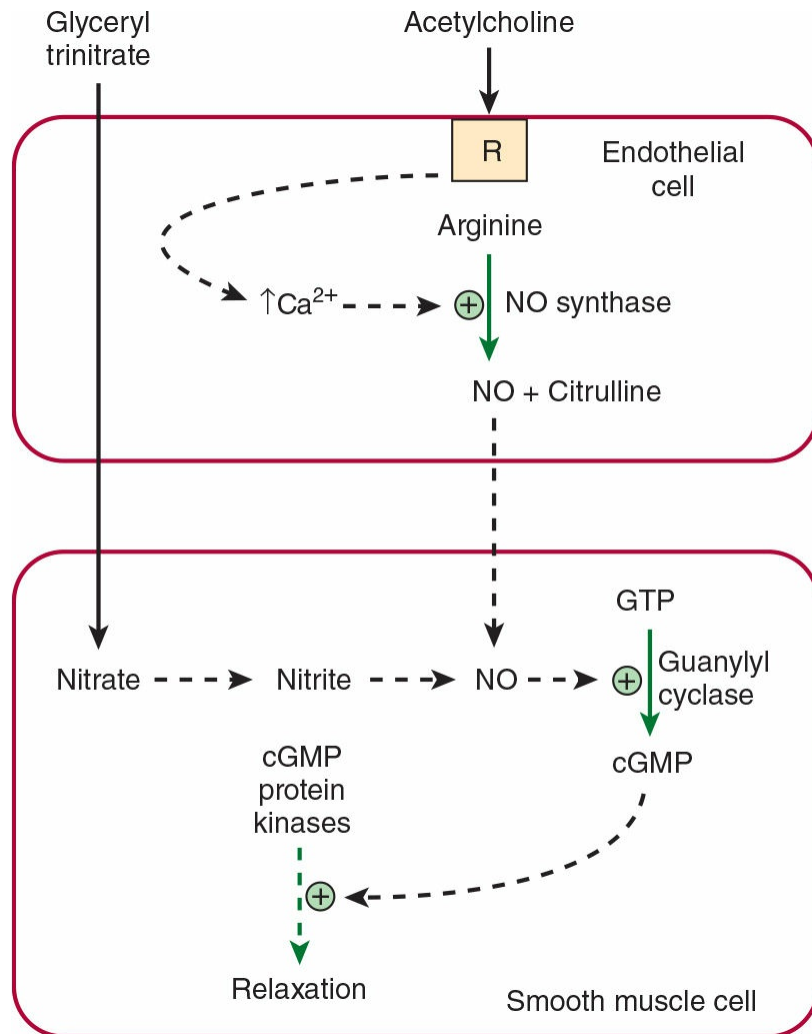

FIGURE 51–12 Diagram showing formation in an endothelial cell of nitric oxide (NO) from arginine in a reaction catalyzed by NO synthase. Interaction of an agonist (eg, acetylcholine) with a receptor (R) leads to intracellular release of Ca^{2+} induced by inositol trisphosphate generated by the phosphoinositide pathway, resulting in activation of NO synthase. The NO subsequently diffuses into adjacent smooth muscle, where it leads to activation of guanylyl cyclase, formation of cGMP, stimulation of cGMP protein kinases, and subsequent relaxation. The vasodilator nitroglycerin is shown entering the smooth muscle cell, where its metabolism also leads to formation of NO.

NO can also be formed from **nitrite**, derived from the metabolism of vasodilators such as glyceryl trinitrate, also known as nitroglycerin, which is commonly administered to treat angina. Another important cardiovascular effect of NO is the inhibition of platelet aggregation, a consequence of the increased synthesis of cGMP. NO has also been implicated in other physiologic processes. For example, it can react with

superoxide to generate **peroxynitrite** (ONOO^-), which can react with tyrosine side chains, forming nitrotyrosine, or generate the highly reactive OH radical when it decomposes.

SKELETAL MUSCLE CONSTITUTES THE MAJOR RESERVE OF PROTEIN IN THE BODY

In humans, **skeletal muscle proteins** are the major nonfat source of stored energy. This explains the large losses of muscle mass, particularly in adults, that accompany prolonged caloric undernutrition.

THE CYTOSKELETON PERFORMS MULTIPLE CELLULAR FUNCTIONS

All cells perform mechanical work, albeit of lower physical magnitude than muscle cells. These include self-propulsion, cytokinesis, endocytosis, exocytosis, and phagocytosis. Like muscle cells, the core of this machinery is comprised of filamentous protein polymers called the **cytoskeleton**. The cytoskeleton's more quantitatively prominent filamentous structures include **actin filaments** (also known as microfilaments), **microtubules**, and **intermediate filaments**.

Nonmuscle Cells Contain Microfilaments Containing G-Actin

G-actin is present in most if not all cells of the body. Under physiologic conditions, G-actin monomers spontaneously polymerize to form double helical **F-actin** filaments, 7 to 9.5 nm in diameter, similar to those found in muscle. The actin microfilaments of the cytoskeleton generally exist as bundles within a tangled-appearing meshwork. These prominent bundles, which just underlie the plasma membranes of many cells, are referred to as **stress fibers**. Stress fibers disappear as cell motility increases or upon malignant transformation of cells.

Two types of actin can be found in the cytoskeletal microfilaments, called β -actin and γ -actin. Although not organized as in muscle, actin filaments in nonmuscle cells can interact with **myosin** to cause cellular movements.

Microtubules Contain α - & β -Tubulins

Microtubules, an integral component of the cellular cytoskeleton, consist of cytoplasmic tubes, 25 nm in diameter that are often of extreme length (**Figure 51–13**). Each cylindrical tube is comprised of 13 longitudinally arranged protofilaments comprised of **α -tubulin** and **β -tubulin**, closely related proteins of ≈ 50 kDa molecular mass. Assembly starts with the formation of tubulin dimers that assemble into protofilaments that associate with one another in parallel to form sheets and eventually cylinders. **GTP** is required for assembly. A microtubule-organizing center, located around a pair of centrioles, nucleates the growth of new microtubules. A third species of tubulin, **γ -tubulin**, appears to play an important role in this process.

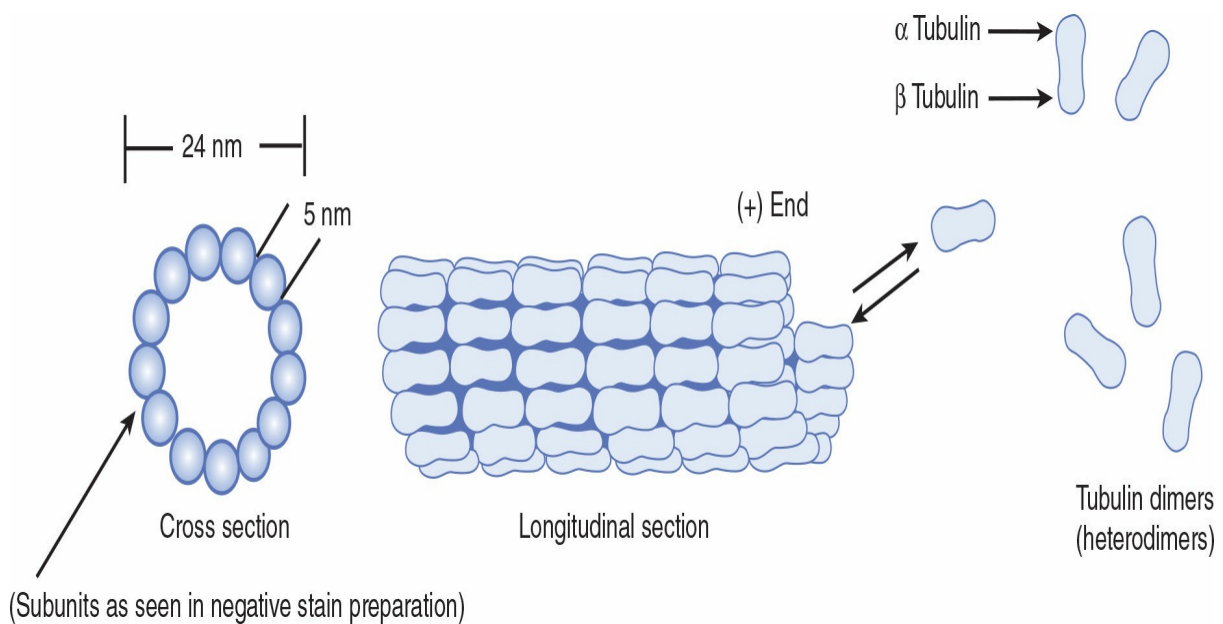

FIGURE 51–13 Schematic representation of microtubules. At left and center are shown drawings of microtubules as seen in the electron microscope following fixation with tannic acid in glutaraldehyde. The unstained tubulin subunits are delineated by the dense tannic acid. Cross sections of tubules reveal a ring of 13 subunits of dimers arranged in a spiral. Changes in microtubule length are due to the addition or loss of individual tubulin subunits. Characteristic arrangements of microtubules (not shown here) are found in centrioles, basal bodies, cilia, and flagellae. (Reproduced, with permission, from Junqueira LC, Carneiro J, Kelley RO: *Basic Histology*, 7th ed. Appleton & Lange, 1992.)

Microtubules are necessary for the formation and function of the **mitotic spindle** responsible for chromosome segregation during cell division. They are also involved in the intracellular movement of

endocytic and exocytic vesicles and form the major structural components of **cilia** and **flagella**. Microtubules are a major component of **axons** and **dendrites**, in which they maintain structure and participate in the axoplasmic flow of material along these neuronal processes. Microtubules also contain a variety of **microtubule-associated proteins [MAPs]**, one of which is **tau**, which also play important roles in microtubule assembly and stabilization.

Microtubules are in a state of dynamic instability, constantly assembling and disassembling. They exhibit **polarity** (plus and minus ends); a feature important to both in their growth from centrioles and their ability to direct intracellular movement. For instance, in axonal transport, the protein **kinesin**, with a myosin-like ATPase activity, uses hydrolysis of ATP to move vesicles down the axon toward the positive end of the microtubular formation. Flow of materials in the opposite direction, toward the negative end, is powered by **cytosolic dynein**, another protein with ATPase activity. Similarly, **axonemal dyneins** power ciliary and flagellar movement while **dynamain**, which uses GTP instead of ATP, is involved in endocytosis. Kinesins, dyneins, dynamain, and myosins are referred to as **molecular motors**.

An absence of dynein in cilia and flagella results in immotile cilia and flagella, leading to male sterility, situs inversus, and chronic respiratory infection, a condition known as **Kartagener syndrome** (OMIM 244400). Mutations in genes affecting the synthesis of dynein have been detected in individuals with this syndrome. Certain **drugs** bind to microtubules and thus interfere with their assembly or disassembly. These include **colchicine** (used for treatment of acute gouty arthritis), **vinblastine** (a vinca alkaloid used for treating certain types of cancer), **paclitaxel** (Taxol) (effective against ovarian cancer), and **griseofulvin** (an antifungal agent).

Intermediate Filaments Differ From Microfilaments & Microtubules

An intracellular fibrous system exists comprised of filaments with an axial periodicity of 21 nm and a diameter of 8 to 10 nm that is intermediate between that of microfilaments (6 nm) and microtubules (23 nm). At least four classes of **intermediate filaments** are found, as indicated in **Table 51–5**. Each is made up of elongated, fibrous molecules with a central rod domain, an amino-terminal head, and a carboxyl-terminal tail. These subunits assemble in a helical a manner to form repeating tetrameric units to form rope-like fibrils. Intermediate filaments are important structural

components of cells that serve as are **relatively stable** components of the cytoskeleton, not undergoing rapid assembly and disassembly and not disappearing during mitosis, as do actin and many microtubular filaments. An important exception to this are the **lamins**, which, subsequent to phosphorylation, disassemble at mitosis and reappear when it terminates. **Lamins** form a meshwork positioned in apposition to the inner nuclear membrane.

TABLE 51–5 Classes of Intermediate Filaments of Eukaryotic Cells and Their Distributions

Proteins	Molecular Mass (kDa)	Distributions
Lamins A, B, and C	65-75	Nuclear lamina
Keratins		
Type I (acidic)	40-60	Epithelial cells, hair, nails
Type II (basic)	50-70	As for type I (acidic)
Vimentin-like		
Vimentin	54	Various mesenchymal cells
Desmin	53	Muscle
Glial fibrillary acid protein	50	Glial cells
Peripherin	66	Neurons
Neurofilaments		
Low (L), medium (M), and high (H) ^a	60-130	Neurons

Mutations in the gene encoding **lamin A** and **lamin C** cause Hutchinson-Gilford progeria syndrome (**progeria**) [OMIM 176670]. A farnesylated form (see [Figure 26–2](#) for the structure of farnesyl) of prelamin A accumulates in this condition, because the site at which the farnesylated portion of lamin A is normally cleaved by proteases has been altered by mutation. Lamin A is an important component of the structural scaffolding that maintains the integrity of the nucleus of a cell. It appears that the accumulation of farnesylated prelamin A destabilizes nuclei, altering their shape, somehow predisposing victims to **manifest signs of premature aging**. Experiments in mice have indicated that administration of a farnesyltransferase inhibitor may ameliorate the development of

misshapen nuclei. Children affected by this condition often die in their teens of atherosclerosis.

Keratins form a large family consisting of about 30 members. As indicated in [Table 51–5](#), two major types of keratins are found that assemble into **heterodimers** made up of one member of each class. **Vimentins** are widely distributed in mesodermal cells. Desmin, glial fibrillary acidic protein, and peripherin are related to them. All members of the vimentin-like family can copolymerize with each other.

Intermediate filaments in nerve cells, called neurofilaments, are classified as low, medium, and high on the basis of their molecular masses. The **distribution of intermediate filaments** in normal and abnormal (eg, cancer) cells can be studied by the use of immunofluorescent techniques, using antibodies of appropriate specificities. These antibodies to specific intermediate filaments can also be of use to pathologists in helping to decide the origin of certain dedifferentiated malignant tumors. These tumors may still retain the type of intermediate filaments found in their cell of origin.

A number of **skin diseases**, mainly characterized by blistering, have been found to be due to mutations in genes encoding **various keratins**. Two of these disorders are epidermolysis bullosa simplex (OMIM 131800) and epidermolytic palmoplantar keratoderma (OMIM 144200). The **blistering** found in these disorders probably reflects a diminished capacity of various layers of the skin to resist mechanical stresses due to abnormalities in the keratin structure.

SUMMARY

- The myofibrils of skeletal muscle consist of thick, myosin-based and thin, actin-based filaments.
- During contraction, these interdigitating filaments slide past one another with cross-bridges between myosin and actin generating and sustaining tension.
- Muscle contraction is driven by the cyclic attachment, conformational shift, and detachment of massive numbers of myosin head domains to adjacent actin fibrils.
- The hydrolysis of ATP is used to drive movement of the filaments. ATP binds to myosin heads and is hydrolyzed to ADP and P_i by the ATPase activity of the actomyosin complex.
- In striated muscle, the contractile apparatus is held in check by the

troponin complex (troponins T, I, and C) until inhibition is relieved by the binding of Ca^{2+} to troponin C.

- In smooth muscle, the contractile apparatus is held in check by the regulatory light chains in myosin. This block is relieved when the regulatory light chains are phosphorylated by a Ca^{2+} -calmodulin-activated protein kinase, myosin light-chain kinase.
- In skeletal muscle, the SR regulates distribution of Ca^{2+} to the sarcomeres, whereas inflow of Ca^{2+} via Ca^{2+} channels in the sarcolemma is of major importance in cardiac and smooth muscle.
- Ca^{2+} not only initiates contraction, it also activates the calcium efflux systems that will bring contraction to a close.
- Many cases of malignant hyperthermia in humans are due to mutations in the gene encoding the Ca^{2+} release channel.
- Some cases of familial hypertrophic cardiomyopathy are due to missense mutations in the gene coding for the β -myosin heavy chain. Mutations in genes encoding a number of other proteins have also been detected.
- NO is a regulator of vascular smooth muscle; blockage of its formation from arginine causes an acute elevation of blood pressure, indicating that regulation of blood pressure is one of its many functions.
- Duchenne-type muscular dystrophy is due to mutations in the gene, located on the X chromosome, encoding the protein dystrophin.
- Two major types of muscle fibers are found in humans: white (anaerobic) and red (aerobic).
- Nonmuscle cells contain an internal network of fibers called the cytoskeleton that provides the mechanical apparatus needed to maintaining and changing cell shape, cell motility, phagocytosis, etc.
- The cytoskeleton is comprised of a variety of filaments that include actin-based microfilaments, α -tubulin and β -tubulin containing microtubules, and lamin-, keratin-, and vimentin-containing intermediate filaments.
- Mutations in the gene encoding lamin A cause progeria, a condition characterized by symptoms resembling premature aging.
- Mutations in genes for certain keratins cause a number of skin diseases.
- The cytoskeleton provides a scaffold for a variety of molecular motors, such as kinesin and dynein, that participate in vesicle

transport, axonal flow, flagellar motion, and morphologic changes in cell shape.

REFERENCES

- Bhasar AP, Guttman JA, Finlay BB: Manipulation of host-cell pathways by bacterial pathogens. *Nature* 207;449:827.
- Blanchoin L, Bouiemaa-Paterski R, Sykes C, Plastino J: Actin dynamics, architecture, and mechanics in cell motility. *Physiol Rev* 2014;94:235.
- Kull FJ, Endow SA: Force generation by kinesin and myosin cytoskeleton proteins. *J Cell Sci* 2013;126:9.
- Pritchard RH, Shery Huang YY, Terentiev EM: Mechanics of biological networks: from the cell cytoskeleton to connective tissue. *Soft Matter* 2014;10:1864.
- Sanders KM: Regulation of smooth muscle excitation and contraction. *Neurogastroenterol Motil* 2008;20(suppl 1):39.
- Sequeira V, Nijenkamp LL, Regan JA, van der Velden J: The physiological role of cardiac cytoskeleton and its alterations in heart failure. *Biochim Biophys Acta* 2014;1838:700.
- Sweeney HL, Houdusse A: Structural and functional insights into the myosin motor mechanism. *Annu Rev Biophys* 2010;39:539.
- Szent-Gyorgyi AG: The early history of the biochemistry of muscle contraction. *J Gen Physiol* 2004;123:631.

Plasma Proteins & Immunoglobulins

Peter J. Kennelly, PhD, Robert K. Murray, MD, PhD, Molly Jacob, MBBS, MD, PhD & Joe Varghese, MBBS, MD

OBJECTIVES

After studying this chapter, you should be able to:

- List the major functions of blood.
- Describe the principal functions of serum albumin.
- Explain how haptoglobin protects the kidney against formation of damaging iron precipitates.
- Describe the roles of ferritin, transferrin, and ceruloplasmin in iron homeostasis.
- Describe the mechanism by which transferrin, transferrin receptors, and HFE protein regulate the synthesis of hepcidin.
- Explain how iron homeostasis can be perturbed by dietary deficiencies or certain disorders.
- Describe the general structures and functions of the five classes of immunoglobulins.
- Explain how up to a million different immunoglobulins can be

generated utilizing fewer than 150 human genes.

- Describe the activation and mode of action of the complement system.
- Compare and contrast the adaptive and innate immune systems.
- Define the term lectin.
- Outline the key differences between polyclonal and monoclonal antibodies.
- Describe the salient features of autoimmune and immunodeficiency disorders.

BIOMEDICAL IMPORTANCE

The proteins that circulate in blood plasma play important roles in human physiology. **Albumins** facilitate the transit of fatty acids, steroid hormones, and other ligands between tissues, while **transferrin** aids the uptake and distribution of iron. Circulating **fibrinogen** serves as a readily mobilized building block of the fibrin mesh that provides the foundation of the clots used to seal injured vessels. Formation of these clots is triggered by a cascade of latent proteases, or **zymogens**, called blood coagulation factors. Plasma also contains several proteins that function as inhibitors of proteolytic enzymes. **Antithrombin** helps confine the formation of clots to the vicinity of a wound, while α_1 -antiproteinase and α_2 -macroglobulin shield healthy tissues from the proteases that destroy invading pathogens and remove dead or defective cells. Circulating immunoglobulins called **antibodies** form the front line of the body's immune system.

Perturbances in the production of plasma proteins can have serious health consequences. Deficiencies in key components of the blood clotting cascade can result in excessive bruising and bleeding (**hemophilia**). Persons lacking plasma ceruloplasmin, the body's primary carrier of copper, are subject to hepatolenticular degeneration (Wilson disease), while emphysema is associated with a genetic deficiency in the production of circulating α_1 -antiproteinase. More than one in every 30 residents of North America suffer from an **autoimmune disorder**, such as type 1 diabetes, asthma, and rheumatoid arthritis, resulting from the production of aberrant immunoglobulins (**Table 52–1**). Insufficiencies in the production of protective antibodies, such as occur in many persons infected by the **human immunodeficiency virus** (HIV) or patients administered immunosuppressant drugs, render them immunocompromised, extremely

susceptible to infection by microbial and viral pathogens. While the root causes of plasma protein–related diseases such as hemophilia are relatively straightforward, others—in particular many autoimmune disorders—arise due to the complex and cryptic interplay of genetic, dietary, nutritional, environmental, and medical factors.

TABLE 52–1 Prevalence of Selected Autoimmune Diseases Among U.S. Population

Autoimmune Disease	Mean Prevalence Rate (per 100,000)	Percentage Female
Graves disease/ hyperthyroidism	1152	88
Rheumatoid arthritis	860	75
Thyroiditis/ hypothyroidism	792	95
Vitiligo	400	52
Type 1 diabetes	192	48
Pernicious anemia	151	67
Multiple sclerosis	58	64
Primary glomerulonephritis	40	32
Systemic lupus erythematosus	24	88
IgA glomerulonephritis	23	67
Sjogren syndrome	14	94
Myasthenia gravis	5	73
Addison’s disease	5	93
Schleroderma	4	92

THE BLOOD HAS MANY FUNCTIONS

As the primary avenue by which tissues are connected to each other and the surrounding environment, the blood that circulates throughout our body performs a variety of functions. These include delivering nutrients

and oxygen, removing waste products, conveying hormones, and defending against infectious microorganisms (**Table 52–2**). These myriad functions are carried out by a diverse set of components that include cellular entities such as red blood cells, platelets, and leukocytes (see **Chapters 53** and **54**), and the water, electrolytes, metabolites, nutrients, proteins, and hormones that comprise the **plasma**.

TABLE 52–2 Major Functions of Blood

1. **Respiration**—transport of oxygen from the lungs to the tissues and of CO₂ from the tissues to the lungs
2. **Nutrition**—transport of absorbed food materials
3. **Excretion**—transport of metabolic waste to the kidneys, lungs, skin, and intestines for removal
4. Maintenance of the normal **acid–base balance** in the body
5. Regulation of **water balance** through the effects of blood on the exchange of water between the circulating fluid and the tissue fluid
6. Regulation of **body temperature** by the distribution of body heat
7. **Defense** against infection by the white blood cells and circulating antibodies
8. Transport of **hormones** and regulation of metabolism
9. Transport of **metabolites**
10. **Coagulation**

PLASMA CONTAINS A COMPLEX MIXTURE OF PROTEINS

Plasma contains a complex mixture of proteins. Early scientists classified these proteins into three groups, **fibrinogen**, **albumin**, and **globulins**, on the basis of their relative solubility in the presence of added organic solvents such as ethanol or salting out agents such as ammonium sulfate. Subsequently, clinical scientists employed electrophoresis within a **cellulose acetate** matrix to analyze the protein composition of plasma. Using this technique, salt-soluble serum protein fraction separated into five major components designated albumin and the α_1 -, α_2 -, β -, and γ -**globulins**, respectively (**Figure 52–1**). Plasma proteins tend to be rich in disulfide bonds and frequently contain bound carbohydrate

(**glycoproteins**) or lipid (**lipoproteins**). The relative dimensions and molecular masses of several plasma proteins are shown in **Figure 52–2**.

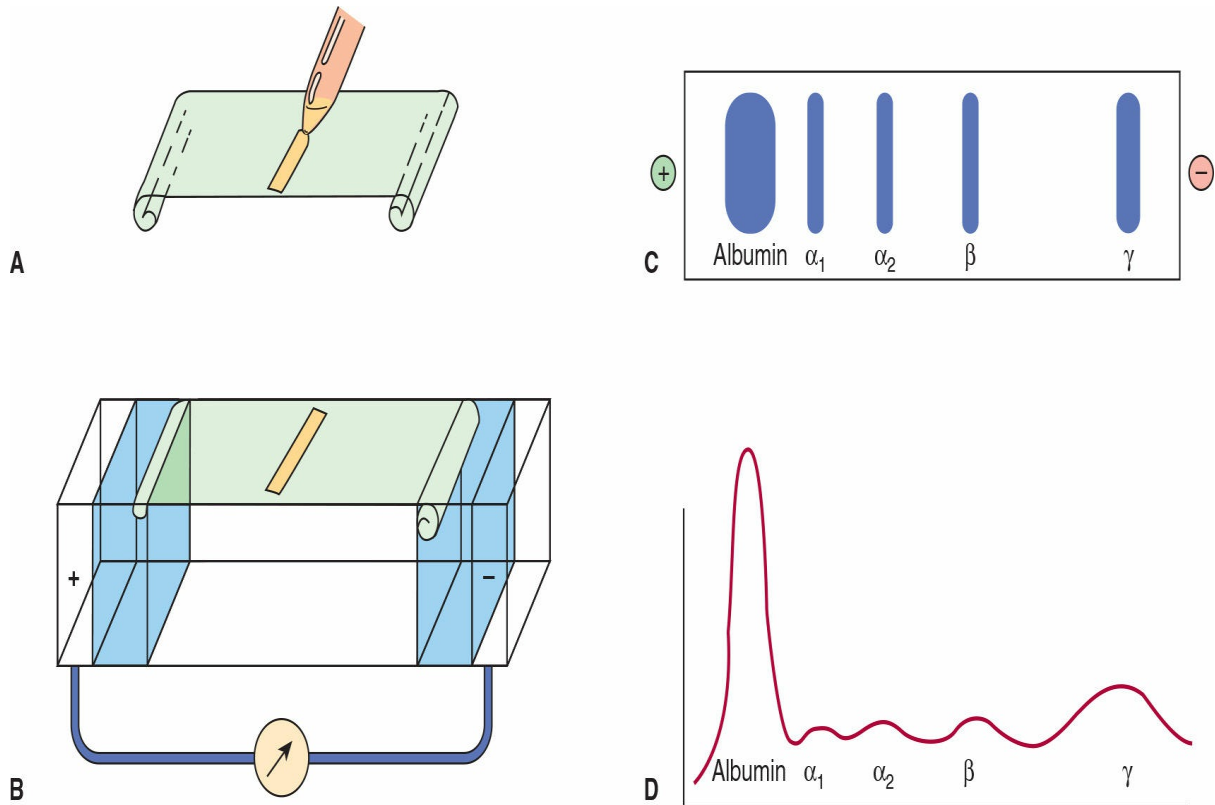

FIGURE 52–1 Technique of cellulose acetate zone electrophoresis. **(A)** A small amount of serum or other fluid is applied to a cellulose acetate strip. **(B)** Electrophoresis in electrolyte buffer is performed. **(C)** Staining enables separated bands of protein to be visualized. **(D)** Densitometer scanning reveals the relative mobilities of albumin, α_1 -globulin, β_2 -globulin, β -globulin, and γ -globulin. (Reproduced, with permission, from Parslow TG et al (editors): *Medical Immunology*, 10th ed. McGraw-Hill, 2001.)

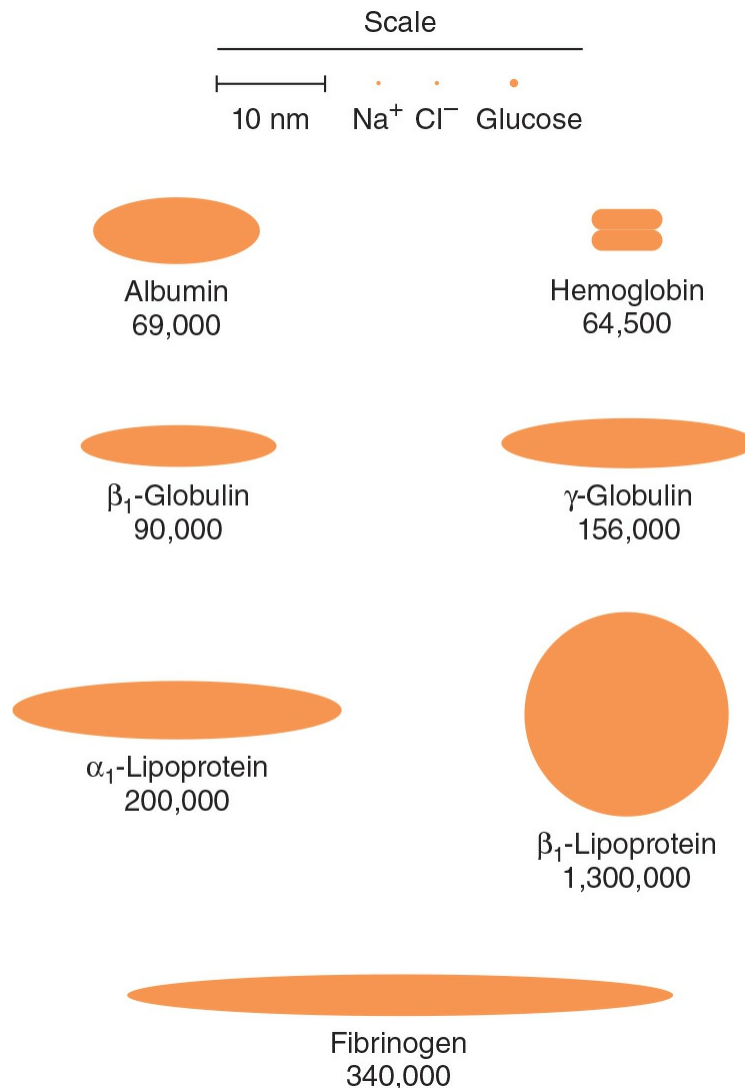

FIGURE 52–2 Relative dimensions and approximate molecular masses of protein molecules in the blood.

Plasma Proteins Help Determine the Distribution of Fluid Between Blood & Tissues

The aggregate concentration of the proteins present in human plasma typically falls in the range of 7 to 7.5 g/dL. The resulting **osmotic pressure** (oncotic pressure) is approximately 25 mm Hg. Since the **hydrostatic pressure** in the arterioles is approximately 37 mm Hg, with an interstitial (tissue) pressure of 1 mm Hg opposing it, a net outward force of about 11 mm Hg drives fluid from the plasma into the interstitial spaces. By contrast, the hydrostatic pressure in venules is about 17 mm Hg; thus, a net force of about 9 mm Hg drives water from tissues back into the circulation. The above pressures are often referred to as the **Starling forces**. If the concentration of plasma proteins is markedly diminished (eg,

due to severe protein malnutrition), fluid will cease flowing back into the intravascular compartment and begin to accumulate in the extravascular tissue spaces, resulting in a condition known as **edema**.

Most Plasma Proteins Are Synthesized in the Liver

Roughly 70 to 80% of all plasma proteins are synthesized in the liver. These include albumin, fibrinogen, transferrin, and most components of the complement and blood coagulation cascades. Two prominent exceptions are von Willebrand factor, which is synthesized in the vascular endothelium, and the γ -globulins, which are synthesized in the lymphocytes. Most plasma proteins are covalently modified by the addition of either N- or O-linked oligosaccharide chains, or both (see [Chapter 46](#)). Albumin is the major exception. These oligosaccharide chains fulfill a variety of functions (see [Table 46–2](#)). Loss of terminal sialic acid residues accelerates clearance of plasma glycoproteins from the circulation.

As is the case for other proteins destined for secretion from a cell, the genes for plasma proteins code for an amino-terminal **signal sequence** that targets them to the endoplasmic reticulum. As this leader sequence emerges from the ribosome, it binds to a transmembrane protein complex in the endoplasmic reticulum called the **signal recognition particle**. The emerging polypeptide chain is pulled through the signal recognition particle into the lumen of the endoplasmic reticulum, during which process the leader sequence is cleaved off by an associated **signal peptidase** (see [Chapter 49](#)). The newly synthesized proteins then traverse the major secretory route in the cell (rough endoplasmic membrane → smooth endoplasmic membrane → Golgi apparatus → secretory vesicles) prior to entering the plasma, during which process they are subject to various posttranslational modifications (proteolysis, glycosylation, phosphorylation, etc). Transit times from the site of synthesis in the hepatocyte from to the plasma vary from 30 minutes to several hours for individual proteins.

Many Plasma Proteins Exhibit Polymorphism

A **polymorphism** is a mendelian or monogenic trait that exists in the population in at least two phenotypes, neither of which is rare (ie, it occurs with frequency of at least 1-2%). Most polymorphisms are innocuous. The ABO blood group substances (see [Chapter 53](#)) are perhaps the best known

example of a human polymorphism. Other human plasma proteins that exhibit polymorphism include α_1 -antitrypsin, haptoglobin, transferrin, ceruloplasmin, and immunoglobulins.

Each Plasma Protein Has a Characteristic Half-Life in the Circulation

The **half-life** of a plasma protein is the time required for 50% of the molecules present at any given moment to be degraded or otherwise cleared from the blood. For example, the half-lives of albumin and haptoglobin in healthy adults are approximately 20 and 5 days, respectively. Under normal circumstances, as older protein molecules are cleared they are replaced by newly synthesized ones, a process called **turnover**. During normal turnover, the total concentration of these proteins will remain constant as the countervailing processes of synthesis and clearance reach a **steady state**.

In certain diseases, the half-life of a protein may be markedly altered. For instance, in some gastrointestinal diseases such as regional ileitis (Crohn disease), considerable amounts of plasma proteins, including albumin, may be lost into the bowel through the inflamed intestinal mucosa. The half-life of albumin in these subjects may be reduced to as little as 1 day, a condition referred to as a **protein-losing gastroenteropathy**.

ALBUMIN IS THE MOST ABUNDANT PROTEIN IN HUMAN PLASMA

The liver synthesizes approximately 12 g of albumin per day, representing about 25% of total hepatic protein synthesis and half its secreted protein. About 40% of the body's albumin circulates in the plasma, where it accounts for roughly three-fifths of total plasma protein by weight (3.4-4.7 g/dL). The remainder resides in the extracellular space. Because of its relatively low molecular mass (about 69 kDa) and high concentration, albumin is thought to contribute 75 to 80% of the **osmotic pressure** of human plasma. Like most other secreted proteins, albumin is initially synthesized as a **preproprotein**. Its **signal peptide** is removed as it passes into the cisternae of the rough endoplasmic reticulum. A second **hexapeptide** is cleaved from the new N-terminus farther along the secretory pathway.

Mature human albumin consists of a single polypeptide chain, 585 amino acids in length, that is organized into three functional domains. Its ellipsoidal conformation is stabilized by a total of 17 intrachain disulfide bonds. A major role of albumin is to bind to and transport numerous **ligands**. These include free fatty acids (FFA), calcium, certain steroid hormones, bilirubin, copper, and tryptophan. A variety of drugs, including sulfonamides, penicillin G, dicumarol, and aspirin, also bind to albumin; a finding with important pharmacologic implications. Preparations of human albumin have been widely used in the treatment of burns and of hemorrhagic shock.

Some humans suffer from genetic mutations that impair their ability to synthesize albumin. Individuals whose plasma is completely devoid of albumin are said to exhibit **analbuminemia**. Surprisingly, persons suffering from albuminemia display only moderate edema. Depressed synthesis of albumin also occurs in a variety of diseases, particularly those of the liver. The plasma of patients with **liver disease** often shows a decrease in the ratio of albumin to globulins (decreased albumin-globulin ratio). The synthesis of albumin decreases relatively early in conditions of protein malnutrition, such as **kwashiorkor**.

THE LEVELS OF CERTAIN PLASMA PROTEINS INCREASE DURING INFLAMMATION OR FOLLOWING TISSUE DAMAGE

Table 52–3 summarizes the functions of many of the plasma proteins. **C-reactive protein** (CRP, so named because it reacts with the C polysaccharide of pneumococci), α_1 -antiproteinase, haptoglobin, α_1 -acid glycoprotein, and fibrinogen are classified as **acute-phase proteins**. Acute-phase proteins are believed to play a role in the body's response to inflammation. C-reactive protein stimulates the complement pathway (see below), while α_1 -antitrypsin neutralizes certain proteases released during acute inflammation.

TABLE 52–3 Some Functions of Plasma Proteins

Function	Plasma Proteins
Antiproteases	Antichymotrypsin α_1 -Antitrypsin (α_1 -antiproteinase) α_2 -Macroglobulin Antithrombin
Blood clotting	Various coagulation factors, fibrinogen
Enzymes	Function in blood, for example, coagulation factors, cholinesterase Leakage from cells or tissues, eg, aminotransferases
Hormones	Erythropoietin ^a
Immune defense	Immunoglobulins, complement proteins, and β_2 -macroglobulin
Involvement in inflammatory responses	Acute phase response proteins (eg, C-reactive protein, α_1 -acid glycoprotein [orosomucoid])
Oncofetal	α_1 -Fetoprotein (AFP)
Transport or binding proteins	Albumin (various ligands, including bilirubin, free fatty acids, ions [Ca^{2+}], metals [eg, Cu^{2+} , Zn^{2+}], metheme, steroids, other hormones, and a variety of drugs) Corticosteroid-binding globulin (transcortin) (binds cortisol) Haptoglobin (binds extracorporeal hemoglobin) Lipoproteins (chylomicrons, VLDL, LDL, HDL) Hemopexin (binds heme) Retinol-binding protein (binds retinol) Sex-hormone-binding globulin (binds testosterone, estradiol) Thyroid-binding globulin (binds T_4 , T_3) Transferrin (transport iron) Transthyretin (formerly prealbumin; binds T_4 and forms a complex, with retinol-binding protein)

The levels of acute-phase proteins may increase by 50% to as much as 1000-fold (in the case of CRP) during chronic inflammatory states and in

patients with cancer. **Interleukin 1 (IL-1)**, a polypeptide released from mononuclear phagocytic cells, is the principal—but not the sole—stimulator of acute-phase reactant synthesis by hepatocytes. Additional molecules such as IL-6 also participate. Because its concentration can rise so dramatically, CRP is used as a biomarker of tissue injury, infection, and inflammation.

The small proteins such as interferons, ILs, and tumor necrosis factors that facilitate cell–cell communication between the components of the immune system are called **cytokines**. Cytokines can be both autocrine and paracrine in nature. One of the primary targets of IL-1 and IL-6 is **nuclear factor kappa-B (NFκB)**, a transcription factor that regulates the expression of the genes encoding many cytokines, chemokines, growth factors, and cell adhesion molecules. NFκB, a heterodimer comprised of a 50- and a 65-kDa polypeptide, normally resides in the cytosol as an inactive complex with a second protein, NFκB inhibitor-α, also known as **IκBα**. When stimulation by inflammation, injury, or radiation, IκBα becomes phosphorylated, which targets it for ubiquitination and degradation. Once freed from its inhibitory partner, active NFκB translocates to the nucleus where it stimulates transcription of its target genes.

HAPTOGLOBIN PROTECTS THE KIDNEYS

Iron in Senescent Erythrocytes Is Recycled by Macrophages

Erythrocytes normally have a lifespan of approximately 120 days. Senescent or damaged erythrocytes are phagocytosed by macrophages of the reticuloendothelial system (RES) present in the spleen and liver. Around 200 billion erythrocytes are catabolized every day. Within the macrophage, heme derived from hemoglobin is converted by the enzyme **heme oxygenase** to biliverdin (see [Figure 31–13](#)), releasing carbon monoxide and iron as by-products. Iron released from heme is exported from phagocytic vesicles in the macrophage by **NRAMP 1** (natural resistance–associated macrophage protein 1), a transporter homologous to DMT1. Iron is subsequently secreted into the circulation by the transmembrane protein ferroportin ([Figure 52–3](#)). Thus, ferroportin plays a central role in both iron absorption by the intestine and iron secretion from macrophages.

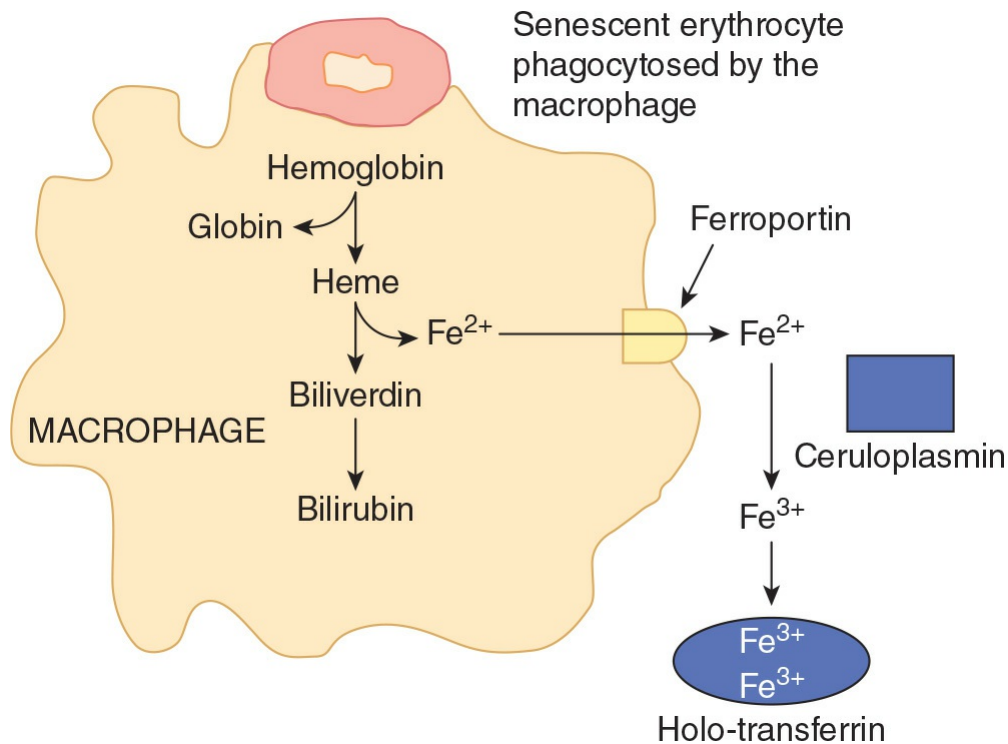

FIGURE 52–3 Recycling of iron in macrophages. Senescent erythrocytes are phagocytosed by macrophages. Hemoglobin is degraded and iron is released from heme by the action of the enzyme heme oxygenase. Ferrous iron is then transported out of the macrophage via ferroportin (Fp). In the plasma, it is oxidized to the ferric form by ceruloplasmin before binding to transferrin (Tf). Iron circulates in blood tightly bound to Tf.

In the blood, Fe^{2+} is oxidized to Fe^{3+} in a reaction catalyzed by the ferrioxidase **ceruloplasmin** (see below), a copper-containing plasma enzyme synthesized by liver. Once oxidized, Fe^{3+} is then bound to transferrin in blood. The iron released from macrophages in this way (about 25 mg/d) is recycled, thereby reducing the need for intestinal iron absorption, which averages only 1 to 2 mg/d.

Haptoglobin Scavenges Hemoglobin That Has Escaped Recycling

During the course of red blood cell turnover, approximately 10% of an erythrocyte's hemoglobin escapes into the circulation. This free, **extracorpuscular** hemoglobin is sufficiently small at ≈ 65 kDa to pass through the glomerulus of the kidney into the tubules, where it tends to form damaging precipitates. **Haptoglobin** (Hp) is a plasma glycoprotein

that binds extracorporeal hemoglobin (Hb), forming a tight noncovalent complex (Hb-Hp). Human haptoglobin exists in **three polymorphic forms**, known as Hp 1-1, Hp 2-1, and Hp 2-2 that reflect the patterns of inheritance of two genes, designated Hp^1 and Hp^2 . Homozygotes synthesize Hp 1-1 or Hp 1-2, respectively, while Hp 2-1 is synthesized by heterozygotes.

Normally, the level of haptoglobin in a deciliter of human plasma is sufficient to bind 40 to 180 mg of hemoglobin. Since the resulting Hb-Hp complex is too large (≥ 155 kDa) to pass through the glomerulus, the kidney is protected from the formation of harmful precipitates while the loss of the iron associated with extracorporeal hemoglobin is reduced.

Certain other plasma proteins **bind heme**, but not hemoglobin. They include a β_1 -globulin hemopexin, which binds free heme, and **albumin**, which binds metheme (ferric heme) to form methemalbumin. Methemalbumin subsequently transfers this metheme to hemopexin.

Haptoglobin Can Serve as a Diagnostic Indicator

In situations where hemoglobin is constantly being released from red blood cells, such as occurs in hemolytic anemias, the level of haptoglobin can fall dramatically. This decrease reflects the marked difference in the half-lives of free haptoglobin, approximately 5 days, and the Hb-Hp complex, approximately 90 minutes. The level of **haptoglobin-related protein**, a homologue of haptoglobin also present in plasma, is elevated in some patients with cancers, although the significance of this is not understood.

IRON IS STRICTLY CONSERVED

Iron is a key constituent of many human proteins, including hemoglobin, myoglobin, the cytochrome P450 group of enzymes, numerous components of the electron transport chain, and ribonucleotide reductase, which catalyzes the conversion of ribonucleotides into deoxyribonucleotides. Body iron, which is distributed as shown in **Table 52-4**, is highly conserved. A healthy adult loses only about 1 to 1.5 mg ($< 0.05\%$) of their 3 to 4 g of body iron each day. However, an adult premenopausal female can experience iron deficiency due to blood loss during menstruation.

TABLE 52-4 Distribution of Iron in a 70-kg Adult Male^a

Transferrin	3-4 mg
Hemoglobin in red blood cells	2500 mg
In myoglobin and various enzymes	300 mg
In stores (ferritin)	1000 mg
Absorption	1 mg/d
Losses	1 mg/d

Enterocytes can absorb dietary iron in its free, ferrous Fe^{2+} , form, or as heme. Absorption of nonheme iron by enterocytes of the proximal duodenum is a highly regulated process ([Figure 52–4](#)). The transfer of iron across the apical membrane of the enterocytes is mediated via the **divalent metal transporter 1 (DMT1 or SLC11A2)**, a relatively nonspecific transporter that also conveys Mn^{2+} , Co^{2+} , Zn^{2+} , Cu^{2+} , and Pb^{2+} . Since DMT1 is specific for divalent metal ions, free ferric iron (Fe^{3+}) must be converted to its ferrous form (Fe^{2+}) by ingested reducing agents such as vitamin C or enzymatically by a brush border membrane-bound ferrireductase, **duodenal cytochrome b (Dcytb)**. Absorbed heme-bound iron is released by the enzymatic action of heme oxygenase (see [Chapter 31](#)).

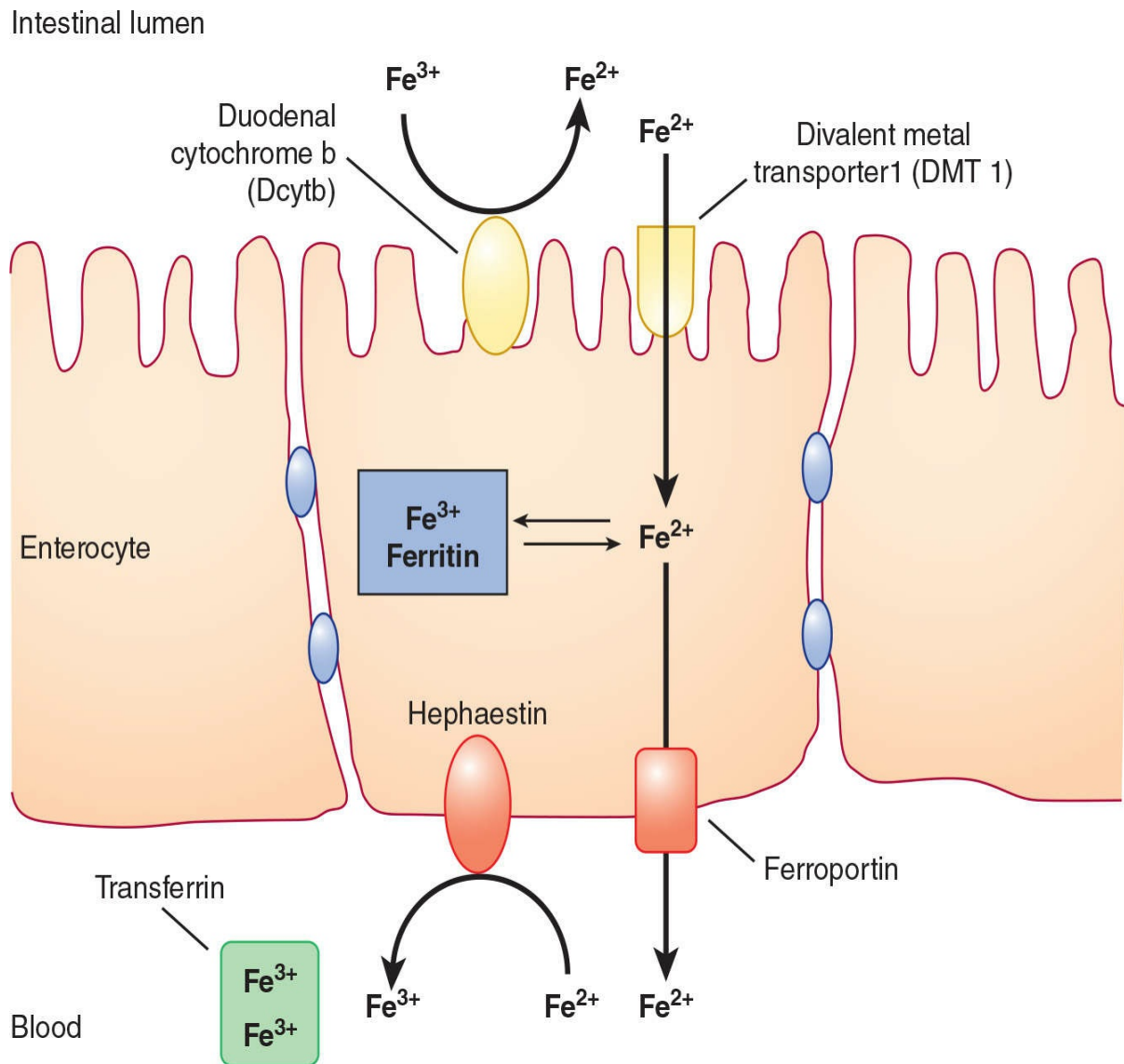

FIGURE 52–4 Nonheme iron transport in enterocytes. Ferric iron is reduced to the ferrous form by a luminal ferrireductase, duodenal cytochrome b (Dcytb). Ferrous iron is transported into the enterocyte via divalent metal transporter1 (DMT1). Within the enterocyte, iron is either stored as ferritin, or transported out of the cell by ferroportin (Fp). Ferrous iron is oxidized to its ferric form by hephaestin. The ferric iron is then bound by transferrin for transport by the blood to various sites in the body. (Based on Andrews NC: Forging a field: the golden age of iron biology. Blood 2008;112;219.)

Once inside the enterocytes, iron can either be stored bound to the iron-storage protein **ferritin** or transferred across the basolateral membrane by the iron exporter protein **ferroportin**, also known as **iron-regulated protein 1 (IREG1 or SLC40A1)**. In the plasma, iron is transported in the

Fe³⁺ form bound to the transport protein, **transferrin**. **Hephaestin**, a copper-containing ferroxidase homologous to ceruloplasmin, oxidizes Fe²⁺ to Fe³⁺ prior to export. Any excess ferritin-bound iron remaining in the enterocytes is disposed of when they are sloughed off into the gut lumen.

Ferritin Can Bind Thousands of Fe³⁺ Atoms

The human body can typically store up to 1 g of iron, the vast majority of which is bound to **ferritin**. Ferritin (MW 440 kDa) forms a hollow ball composed of two-dozen ≈19-21 kDa polypeptide subunits that can encapsulate as many as 3000 to 4500 ferric atoms. The subunits may be of the H (heavy) or the L (light) type. The H-subunit possesses ferroxidase activity, which is required for iron-loading of ferritin. The L-subunit is proposed to play a role in ferritin nucleation and stabilization. Normally, a small amount of ferritin is present in human plasma (50-200 μg/dL) proportionate to the total stores of iron in the body. Plasma ferritin levels thus are used as an **indicator of body iron stores**. However, it is not known whether ferritin in plasma is derived from damaged cells or secretion by healthy ones. In addition, **hemosiderin**, a partly degraded form of ferritin may appear in tissues under conditions of iron overload (**hemosiderosis**).

Transferrin Shuttles Iron to Where It Is Needed

The toxicity of free iron is largely a consequence of its ability to induce the formation of damaging reactive oxygen species (**Figure 52–5**). Biologic organisms minimize iron's potential toxicity by employing specialized storage and transport proteins, and maintaining it in its less reactive, Fe³⁺ state, during transport. Humans transport iron through the circulation tightly bound to **transferrin (Tf)**, a glycoprotein synthesized by the liver. This β₁-globulin has a molecular mass of approximately 76 kDa and contains two high-affinity binding sites for Fe³⁺. Glycosylation of transferrin is impaired in **congenital disorders of glycosylation** (see **Chapter 46**) or in **chronic alcoholism**. Hence, **carbohydrate-deficient transferrin (CDT)** is sometimes used as a biomarker of chronic alcoholism.



FIGURE 52–5 The Fenton reaction. Free iron is extremely toxic as it can catalyze the formation of hydroxyl radical (OH^\cdot) from hydrogen peroxide (see also [Chapter 53](#)). The hydroxyl radical is a transient but highly reactive species and that oxidize cellular macromolecules resulting in tissue damage.

The concentration of Tf in plasma is approximately 300 mg/dL, sufficient to carry a total of approximately 300 μg of iron per deciliter of plasma. This figure represents the **total iron-binding capacity (TIBC)** of plasma. Typically, about 30% of the iron-binding sites in transferrin are occupied. Occupancy can decrease to less than 16% during severe iron deficiency and may increase to more than 45% in iron overload conditions.

The Transferrin Cycle Facilitates Cellular Uptake of Iron

For the delivery of transported iron, the recipient cell must bind circulating transferrin via a cell surface receptor, the **transferrin receptor 1 (TfR1)**. The receptor-transferrin complex is then internalized by **receptor-mediated endocytosis** (see [Chapter 25](#)) and bound iron released as late endosomes become acidified. The free iron leaves the endosome via DMT1 and enters the cytoplasm. apoTf (Tf without bound iron) is then recycled. First, the transferrin receptor returns to the plasma membrane with apoTf still bound. Upon reaching the cell surface, apoTf dissociates from the receptor and reenters the plasma, where it picks up more iron for delivery to cells. This is called the **transferrin cycle** ([Figure 52–6](#)).

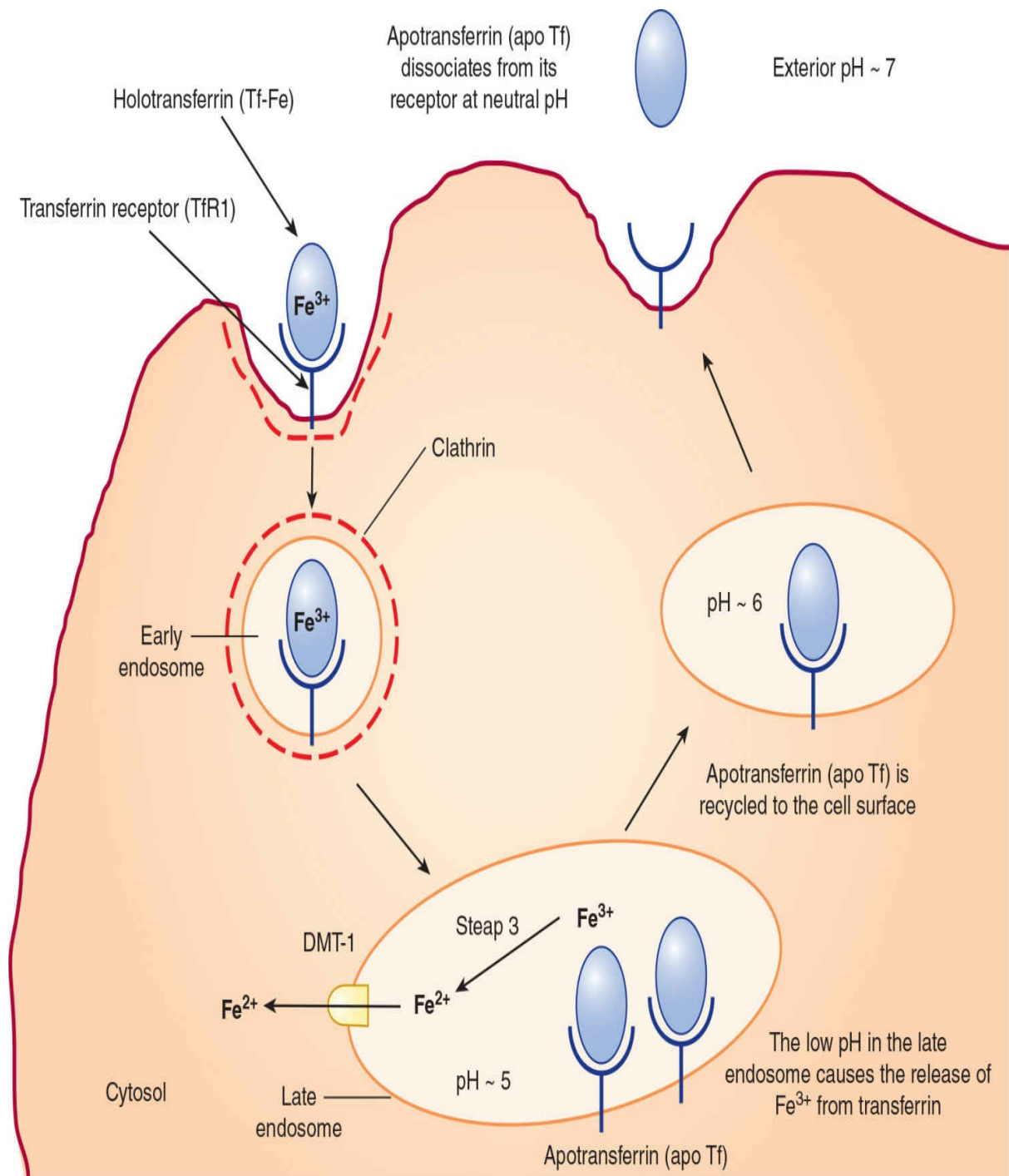

FIGURE 52–6 The transferrin cycle. Holotransferrin (Tf-Fe) binds to transferrin receptor 1 (TfR1) present in clathrin-coated pits on the cell surface. The TfR1–Tf-Fe complex is endocytosed and the endocytic vesicles fuse to form early endosomes. The early endosomes mature in to late endosomes, which have a low internal pH. These acidic conditions cause the release of iron from transferrin. The resulting apotransferrin (apoTf) remains bound to TfR1. Ferric iron is converted to its ferrous form by the ferrireductase, Steap 3, and is then transported to the cytosol via

DMT1. The TfR1-apoTf complex then is recycled back to the cell surface. At the cell surface, apoTf is released from TFR1. TfR1 then binds to new Tf-Fe. This completes the transferrin cycle.

While transferrin receptor 1 is found on the surface of most cells, the homologous **transferrin receptor 2 (TfR2)** is encountered primarily on the surface of hepatocytes and the crypt cells of the small intestine. The affinity of TfR2 for Tf-Fe is much lower than that of TfR1, optimizing the former as a sensor, rather than an importer, for iron.

Oxidation by Ceruloplasmin Is a Key Feature of the Iron Cycle

Macrophages play a key role in the turnover of red blood cells. Following phagocytosis and digestion via lysosomal hydrolases, the iron is expelled largely in the ferrous, Fe^{2+} , state. In order to be recovered via the transferrin cycle, this iron must be oxidized to the ferric, Fe^{3+} , state by the ferroxidase **ceruloplasmin**, a 160-kDa α_2 -globulin synthesized by the liver. With six, catalytically essential, copper atoms, ceruloplasmin is the major copper-containing protein in plasma.

Deficiencies in Ceruloplasmin Perturb Iron Homeostasis

Ceruloplasmin deficiency can arise from genetic causes as well as a lack of copper, an essential micronutrient, in the diet. When adequate quantities of catalytically functional ceruloplasmin are lacking, the body's ability to recycle Fe^{2+} becomes impaired, leading to iron accumulation in tissues. While persons suffering from **hypoceruloplasmenia**, a genetically heritable condition in which ceruloplasmin levels are roughly 50% of normal, generally display no clinical abnormalities, genetic mutations that abolish the ferroxidase activity of ceruloplasmin, **aceruloplasminemia**, can have severe physiologic consequences. If left untreated, the progressive accumulation of iron in pancreatic islet cells and basal ganglia eventually leads to the development of insulin-dependent diabetes and neurologic degeneration that may manifest as dementia, dysarthria, and dystonia.

Ceruloplasmin Levels Decrease in Wilson Disease

In **Wilson disease**, a mutation in the gene for a **copper-binding P-type ATPase** (ATP7B protein) blocks the excretion of excess copper in the bile. As a consequence, copper accumulates in the liver, brain, kidney, and red blood cells. Paradoxically, rising levels of copper within the liver apparently interferes with the incorporation of this metal into newly synthesized ceruloplasmin polypeptides (apoceruloplasmin) leading to a fall in plasma ceruloplasmin levels. If left untreated, patients suffering from this form of **copper toxicosis** may develop a hemolytic anemia or chronic liver disease (cirrhosis and hepatitis). Accumulation of copper in the basal ganglia and other centers can lead to neurologic symptoms. Wilson disease can be treated by limiting the dietary intake of copper while depleting any excess copper by the regular administration of **penicillamine**, which chelates copper and is subsequently excreted in the urine.

INTRACELLULAR IRON HOMEOSTASIS IS TIGHTLY REGULATED

Synthesis of TfR1 and Ferritin Are Reciprocally Regulated

The synthesis of TfR1 and ferritin are reciprocally linked to intracellular iron levels. When iron is low, the rate of TfR1 synthesis increases and that of ferritin declines. The opposite occurs when iron is abundant and tissue needs have been sated. Control is exerted through the binding of iron regulatory proteins (IRPs) to hairpin loops structures called **iron response elements (IREs)** located in the 5' and 3' untranslated regions (UTRs) of the mRNAs coding for ferritin and TfR1, respectively (**Figure 52–7**). IRPs bind to the IREs only when intracellular iron levels are low. Binding at the 3' UTR of the mRNA for TfR1 stabilizes it, thereby increasing TfR1 synthesis, while binding of an IRP to the IRE located at the 5' UTR of ferritin mRNA blocks translation. Similarly, when iron levels are high, the IRBs dissociate. Under these circumstances translation of ferritin mRNA is facilitated and TfR1 mRNA is rapidly degraded.

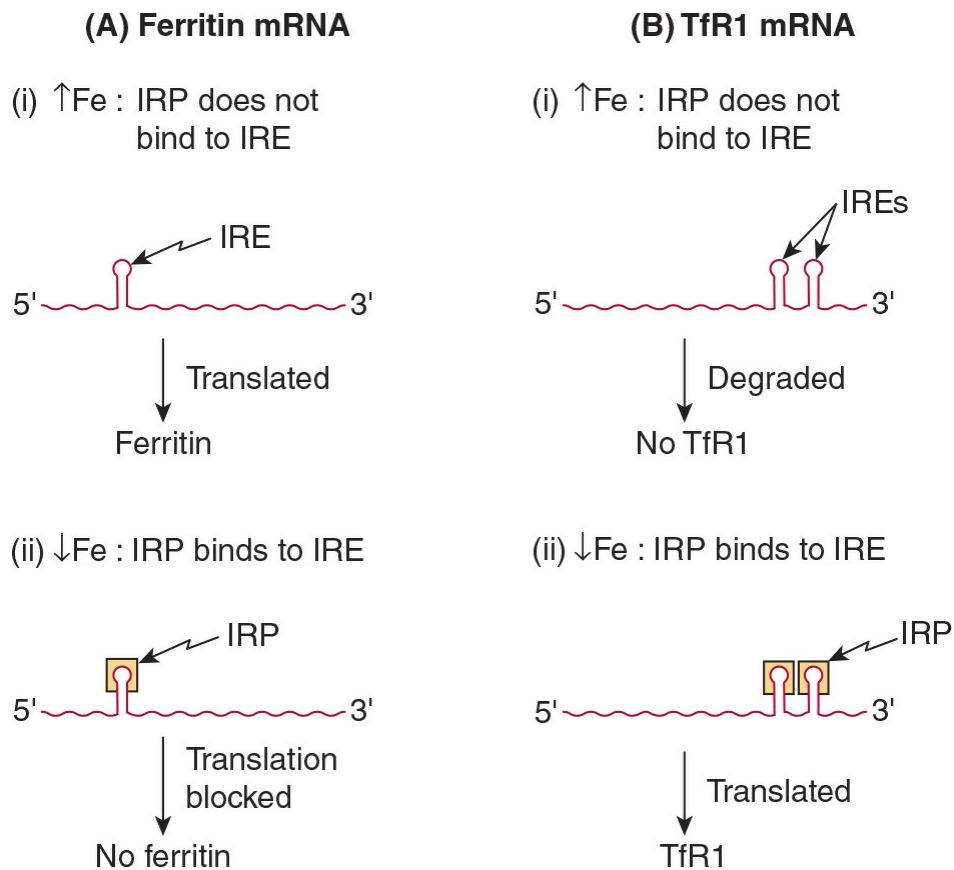

FIGURE 52–7 Schematic representation of the reciprocal relationship between synthesis of ferritin and the transferrin receptor (TfR1). The mRNA for ferritin is represented on the left, and that for TfR1 on the right of the diagram. At high concentrations of iron, the iron bound to the IRP prevents that protein from binding the IREs on either type of mRNA. The mRNA for ferritin is able to be translated under these circumstances, and ferritin is synthesized. On the other hand, when the IRP is not able to bind to the IRE on the mRNA for TfR1, that mRNA is degraded. In contrast, at low concentrations of iron the IRP is able to bind to the IREs on both types of mRNA. In the case of the ferritin mRNA, this prevents it from being translated. Hence ferritin is not synthesized. In the case of the mRNA for TfR1, binding of the IRP prevents that mRNA from being degraded, enabling it to be translated and TfR1 to be synthesized. IRE, iron response element; IRP, iron regulatory protein.

Hepcidin Is the Chief Regulator of Systemic Iron Homeostasis

The 25-amino acid peptide **hepcidin** plays a central role in iron homeostasis. Synthesized in the liver as an 84-amino acid precursor

(prohepcidin), **hepcidin binds to the cellular iron exporter, ferroportin, triggering its internalization and degradation.** The consequent decrease in ferroportin produces a “mucosal block” by lowering iron absorption in the intestine and depresses recycling of the iron liberated by red blood cell turnover (**Figure 52–8**). Together, these result in a reduction in circulating iron levels (hypoferremia) as well as reduced placental iron transfer during pregnancy. When plasma iron levels are high, hepatic synthesis of hepcidin increases, reducing both iron absorption and recycling.

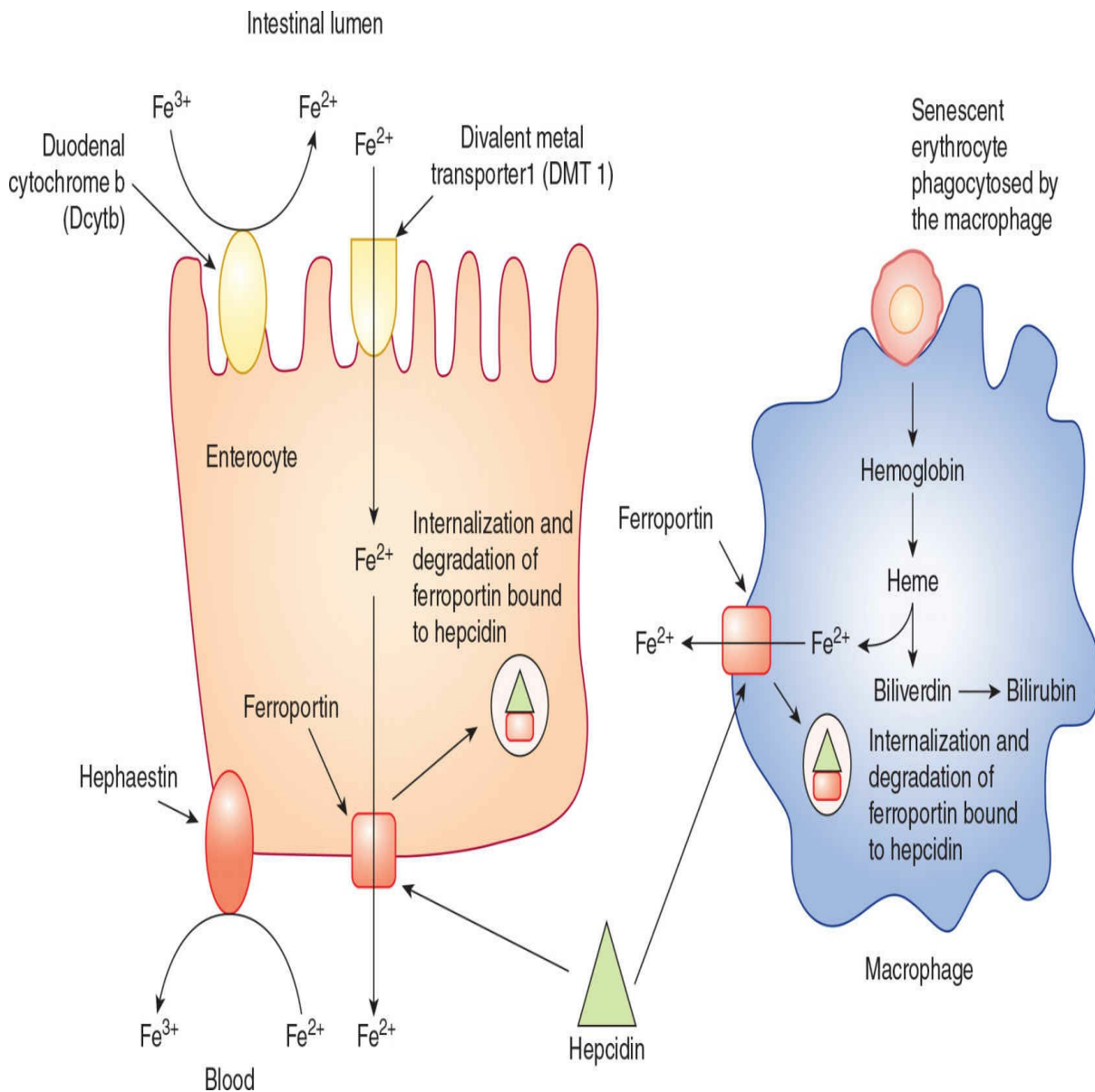

FIGURE 52–8 Role of hepcidin in systemic iron regulation. Hepcidin binds to and triggers the internalization and degradation of ferroportin expressed on the surface of enterocytes and macrophages. This decreases iron absorption from the intestine and inhibits iron release from

macrophages, leading to hypoferremia. (Based on Andrews NC: Forging a field: the golden age of iron biology. *Blood* 2008;112(2):219.)

Hepcidin Expression Is Influenced by Iron, Erythropoiesis, Inflammation, and Hypoxia

Liver cells monitor iron levels using a multicomponent “iron-sensing complex” comprised of two transmembrane receptors whose cores consist of homodimers of **TfR1** and **TfR2**, respectively, linked by a third transmembrane protein, **HFE protein (Figure 52–9)**. HFE protein is a major histocompatibility (MHC) class 1–like molecule that binds **β 2-microglobulin** (a component of class I MHC molecules, not shown in [Figure 52–9](#)) and, normally, TfR1. TfR1 also binds the iron-bound form of transferrin (Tf-Fe). The binding sites for Tf-Fe and HFE overlap. Consequently, when iron is abundant and Tf-Fe levels are high, HFE is displaced from TfR1. The displaced HFE protein then binds to TfR2, forming a complex that can be further stabilized by binding of Tf-Fe. Binding of HFE to TfR2 triggers an intracellular signaling cascade that activates expression of *HAMP*, the gene encoding hepcidin. The gene encoding HFE protein is commonly mutated in hereditary hemochromatosis.

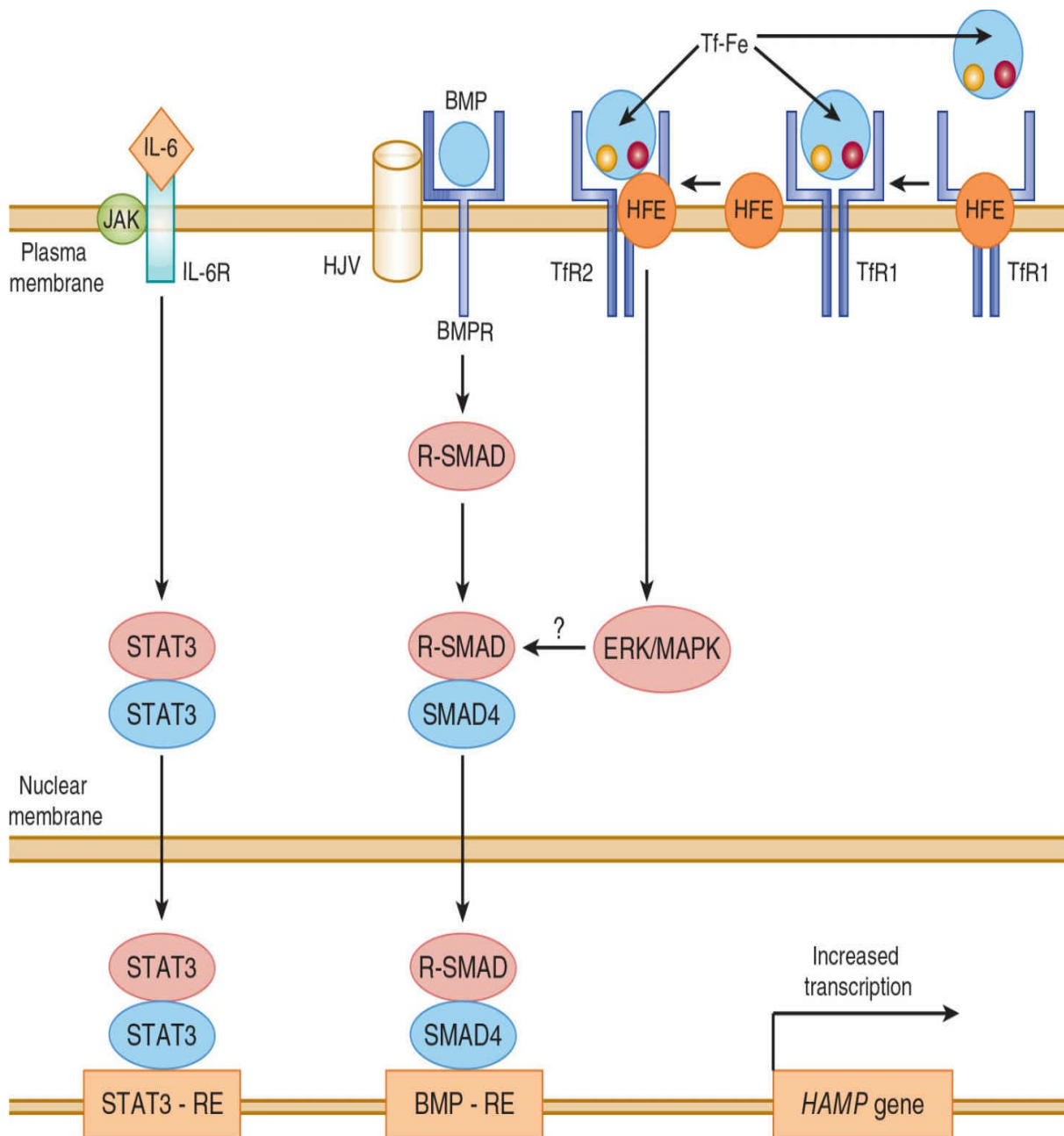

FIGURE 52–9 Regulation of hepcidin gene expression. Tf-Fe (holotransferrin) competes with HFE for binding to TFR1. High levels of Tf-Fe displace HFE from its binding site on TFR1. Displaced HFE binds to TFR2 along with Tf-Fe to signal via the ERK/MAPK pathway to induce hepcidin expression. BMP binds to its receptor BMPR and HJV (coreceptor) to activate R-SMAD. R-SMAD dimerizes with SMAD4, then translocates to the nucleus where it binds to the BMP-RE, resulting in transcriptional activation of hepcidin as shown. IL-6, which is a biomarker of inflammation, binds to its cell surface receptor and activates the JAK-STAT pathway. STAT3 translocates to the nucleus where it binds to its response element (STAT-RE) on the hepcidin gene to induce it. BMP,

bone morphogenetic protein; BMPR, bone morphogenetic protein receptor; BMP-RE, BMP response element; ERK-MAPK, extracellular signal-regulated kinase/mitogen-activated protein kinase; *HAMP*, gene encoding hepcidin antimicrobial peptide (hepcidin); HJV, hemojuvelin; IL-6, interleukin 6; IL-6R, interleukin 6 receptor; JAK, Janus-associated kinase; SMAD, Sma and MAD (mothers against decapentaplegic)-related protein; STAT, signal transduction and activator of transcription; STAT3-RE, STAT 3 response element; TfR1, transferrin receptor 1; TfR2, transferrin receptor 2. (Redrawn from Hentz MW, Muckenthaler MU, Gali B, et al: Two to tango: regulation of mammalian iron metabolism. *Cell* 2010;142:24.)

Bone Morphogenetic Proteins Influence Hepcidin Expression

While **bone morphogenic proteins** (BMPs) act by mechanisms that are distinct from HFE protein, considerable cross-talk exists between these pathways. BMP binds to a cell surface receptor (BMPR) whose binding affinity is augmented by binding to a coreceptor, **hemojuvelin** (HJV). The activation of the BMPR-HJV complex triggers the phosphorylation of intracellular signaling proteins called **SMADs**, which stimulates the transcription of the gene that codes for hepcidin (Figure 52–9).

Erythropoietic Signals Regulate Hepcidin Levels

Synthesis of hepcidin is induced by cytokines such as **interleukin 6 (IL-6)** that are released as part of an inflammatory response. Binding of IL-6 to its cell surface receptor stimulates gene expression by activating the JAK-STAT (Janus kinase—signal transducer and activator of transcription) pathway (Figure 52–9). Inflammation-associated cytokines are thought to trigger the increase in hepcidin levels that accompanies **anemia of inflammation (AI)**. AI manifests as a microcytic, hypochromic anemia that is refractory to iron supplementation.

Hepcidin expression decreases during hypoxia or β -thalassemia. The former is mediated by erythropoietin, whose synthesis is controlled by hypoxia-inducible transcription factors 1 and 2 (HIF-1 and HIF-2). In β -thalassemia, the expression of hepcidin is inhibited by **growth differentiation factor 15 (GDF15)** and **twisted gastrulation 1 (TWSG1)**, which are secreted by erythroblasts.

IRON DEFICIENCY & ANEMIA ARE COMMON WORLDWIDE

Iron deficiency is extremely common in many parts of the world, especially in developing countries. Major causes of iron insufficiency include dietary deficiency, malabsorption, gastrointestinal bleeding, and episodic blood loss such as from menstruation. Persistent iron deficiency will lead to the progressive depletion of bodily iron stores. If the level of transferrin saturation falls to 20% or below, hemoglobin synthesis will be impaired, resulting in **iron-deficient erythropoiesis**. Hemoglobin levels in blood will gradually fall, resulting in **iron-deficiency anemia**. Patients typically present a **hypochromic, microcytic blood picture** that is accompanied by fatigue, pallor, and reduced exercise capacity.

The erythrocytes of persons suffering from iron deficient anemia display increased levels of surface transferrin receptor-1 and deficits in the ferrochelatase-catalyzed incorporation of iron into protoporphyrin IX. The resulting rise in the levels of **soluble transferrin receptor protein (sTfR)** released into the plasma by partial proteolysis of cell surface transferrin receptors and the accumulation of **red-cell protoporphyrin** serve as diagnostic biomarkers for iron deficiency anemia. Estimation of the serum sTfR level is especially useful for distinguishing anemia due to chronic inflammation, which does not affect the level of erythrocyte transferrin receptors, from iron deficiency anemia. **Table 52–5** summarizes the levels of these and other clinically utilized biomarkers typically observed as patients progress through each stage of iron deficiency anemia.

TABLE 52–5 Changes in Various Laboratory Tests Used to Assess Iron-Deficiency Anemia

Parameter	Normal	Negative Iron Balance	Iron-Deficient Erythropoiesis	Iron-Deficiency Anemia
Serum ferritin (µg/dL)	50-200	Decreased <20	Decreased <15	Decreased <15
Total iron binding capacity (TIBC) (µg/dL)	300-360	Slightly increased >360	Increased >380	Increased >400
Serum iron (µg/dL)	50-150	Normal	Decreased <50	Decreased <30
Transferrin saturation (%)	30-50	Normal	Decreased <20	Decreased <10
RBC protoporphyrin (µg/L)	30-50	Normal	Increased	Increased
Soluble transferrin receptor (µg/L)	4-9	Increased	Increased	Increased
RBC morphology	Normal	Normal	Normal	Microcytic Hypochromic

Hereditary Hemochromatosis Is Characterized by Iron Overload

The presence of stainable iron in tissues, **hemosiderosis** , is characteristic of individuals suffering from **hemochromatosis** or iron overload. Hereditary hyperabsorption of iron by the intestines can be caused by mutations in the *HFE* gene or, less frequently, the genes encoding hepcidin, TfR2, HJV, or ferroportin (**Table 52–6**). **Secondary iron overload** is usually associated with ineffective erythropoiesis, as seen in the thalassemia syndromes. Repeated blood transfusions can also result in progressive iron overload, iron accumulation in tissues, and the generation of toxic reactive oxygen species.

TABLE 52–6 Iron Overload Conditions

<p>Hereditary Hemochromatosis</p> <ul style="list-style-type: none">• HFE-related hemochromatosis (type 1)• Non-HFE-related hemochromatosis<ul style="list-style-type: none">• H_o Juvenile hemochromatosis (type 2)<ul style="list-style-type: none">• Heparidin mutation (type 2A)• Hemojuvelin mutation (type 2B)• H_o Transferrin receptor 2 mutation (type 3)• H_o Ferroportin mutation (type 4)
<p>Secondary Hemochromatosis</p> <ul style="list-style-type: none">• Anemia Characterized by ineffective erythropoiesis (eg, thalassemia major)• Repeated blood transfusions• Parenteral iron therapy• Dietary iron overload (Bantu siderosis)
<p>Miscellaneous Conditions Associated with Iron Overload</p> <ul style="list-style-type: none">• Alcoholic liver disease• Nonalcoholic steatohepatitis• Hepatitis C infection

SERUM INHIBITORS PREVENT INDISCRIMINATE PROTEOLYSIS

Proteases are essential participants in tissue remodeling, blood clotting, elimination of old or diseased cells, destruction of invading pathogens, and other physiologic functions. Left unchecked, however, proteolytic enzymes that are secreted or escape into the blood can damage healthy

tissue. Protection from indiscriminate proteolysis involves a battery of serum proteins that inhibit, and thereby limit the scope of, protease action.

Deficiency of α_1 -Antiproteinase Is Associated With Emphysema & Liver Disease

α_1 -Antiproteinase, a 394-residue glycoprotein that makes up >90% of the α_1 -albumin fraction, is the principal **serine protease inhibitor (serpin)** in human plasma. Formerly called α_1 -antitrypsin, α_1 -antiproteinase inhibits trypsin, elastase, and other serine proteases by forming an inactive covalent complex with them. α_1 -Antiproteinase is synthesized by hepatocytes and macrophages. At least 75 **polymorphic forms** of this serpin, or Pi, exist. The major genotype is MM, whose phenotypic product is PiM. A deficiency in α_1 -antiproteinase plays a role in some cases (~ 5%) of emphysema, particularly in subjects with the **ZZ genotype** (who synthesize PiZ) and in PiSZ heterozygotes, both of whom secrete lower levels of serpins than PiMM individuals.

Oxidation of Met₃₅₈ Inactivates α_1 -Antiproteinase

In the lungs, components of the smoke produced by burning tobacco products and industrial activities can oxidize a key **methionine** residue, Met₃₅₈, located in the protease-binding domain of α_1 -antiproteinase. Oxidation renders α_1 -antiproteinase unable to covalently bind and neutralize serine proteases. The subsequent damage produced by unchecked proteolytic activity in the lungs can contribute to the development of emphysema. Smoking can be particularly devastating for patients who already have low levels of α_1 -antiproteinase (eg, PiZZ phenotype). Intravenous administration of serpins (augmentation therapy) has been used as an adjunct in the treatment of patients with emphysema that exhibit α_1 -antiproteinase deficiency.

Individuals deficient in α_1 -antiproteinase are also at greater risk of lung damage from pneumonia or other conditions that induce the accumulation of polymorphonuclear white blood cells in the lung. Deficiency of α_1 -antiproteinase is also implicated in **α_1 -antitrypsin deficiency liver disease**, a form of cirrhosis that afflicts persons possessing the ZZ phenotype. In these individuals, substitution of Glu₃₄₂ by **lysine** promotes

the formation of polymeric aggregates of α_1 -antitrypsin in the cisternae of the endoplasmic reticulum in hepatic cells.

α_2 -Macroglobulin Neutralizes Proteases & Targets Cytokines to Tissues

α_2 -Macroglobulin, a member of the thioester plasma protein family, comprises 8 to 10% of the total plasma protein in humans. This homotetrameric glycoprotein is the most abundant member of a group of homologous plasma proteins that include complement proteins C3 and C4. α_2 -Macroglobulin is synthesized by monocytes, hepatocytes, and astrocytes. It mediates the inhibition and clearance of a broad spectrum of trypsin proteases by a “Venus flytrap” mechanism. The key components of the trap include a 35-residue “bait domain” located near the center of its polypeptide sequence and an internal cyclic thioester linking a cysteine and a glutamine residue (**Figure 52–10**). Cleavage of the bait domain produces a massive conformational change, triggering the envelopment of the attacking protease. The reactive thioester then reacts with the protease to covalently link the two proteins. This conformational change also exposes a sequence in α_2 -macroglobulin that is recognized by cell surface receptors that subsequently bind and remove the complex from the plasma.

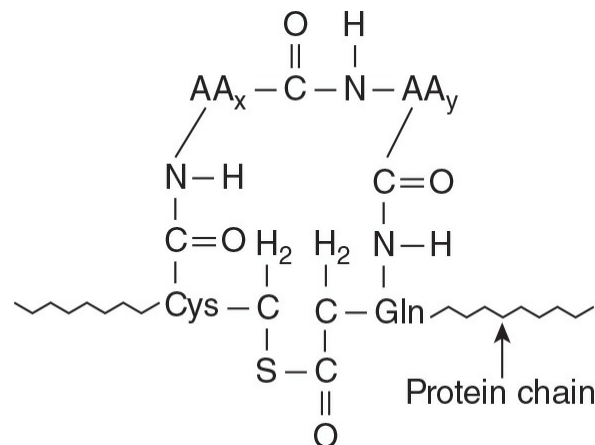

FIGURE 52–10 An internal cyclic thioester bond, as present in α_2 -macroglobulin. AA_x and AA_y are neighboring amino acids to cysteine and glutamine.

In addition to serving as the plasma’s predominant broad-spectrum, or **panprotease**, inhibitor, α_2 -macroglobulin also binds to and transports

approximately 10% of the **zinc** in plasma (the remainder being transported by albumin) as well as **cytokines** such as platelet-derived growth factor and transforming growth factor β . As a cytokine transporter, α_2 -macroglobulin appears to be involved in targeting these effectors toward particular tissues or cells. Once taken up by cells, the cytokines dissociate, freeing them to modulate their growth and function.

DEPOSITION OF PLASMA PROTEINS IN TISSUES LEADS TO AMYLOIDOSIS

Amyloidosis refers to an impairment of tissue function that results from the accumulation of insoluble aggregates of proteins in the interstitial spaces between cells. The term is a misnomer, as it was originally thought that the fibrils were starch-like in nature. The fibrils generally are made up of proteolytic fragments of plasma proteins whose conformation is rich in **β -pleated sheet**. They generally also contain a **P component** derived from a plasma protein closely related to C-reactive protein called **serum amyloid P component**.

Structural abnormalities or overproduction of more than 20 different proteins have been implicated in various types of amyloidosis. **Primary amyloidosis** ([Table 52–7](#)) typically is caused by a monoclonal plasma cell disorder that leads to the accumulation of protein fragments derived from immunoglobulin **light chains** (see below). **Secondary amyloidosis** results from an accumulation of fragments of **serum amyloid A (SAA)** consequent to chronic infections or cancer. In these instances, elevated levels of inflammatory cytokines stimulate the liver to synthesize SAA, which leads to a concomitant rise in its proteolytic degradation products. **Familial amyloidosis** results from accumulation of mutated forms of certain plasma proteins such as **transthyretin** ([Table 52–3](#)). Over 80 mutationally altered forms of this protein have been identified. Patients undergoing regular, long-term dialysis are at risk from **β_2 -microglobulin**, a plasma protein that is retained by dialysis membranes.

TABLE 52–7 A Classification of Amyloidosis

Type	Protein Implicated
Primary	Principally light chains of immunoglobulins
Secondary	Serum amyloid A (SAA)
Familial	Transthyretin; also rarely apolipoprotein A-1, cystain C, fibrinogen, gelsolin, lysozyme
Alzheimer's disease	Amyloid β peptide (see Chapter 57, case no. 2)
Dialysis-related	β_2 -microglobulin

PLASMA IMMUNOGLOBULINS DEFEND AGAINST INVADERS

The three major components of the body's immune system are **B lymphocytes (B cells)**, **T lymphocytes (T cells)**, and **the innate immune system**. B lymphocytes are mainly derived from bone marrow cells, while T lymphocytes originate from the thymus. **B cells** are responsible for the synthesis of circulating, humoral antibodies, also known as **immunoglobulins**. The **T cells** are involved in a variety of important **cell-mediated immunologic processes** such as graft rejection, hypersensitivity reactions, and defense against malignant cells and many viruses. B and T cells respond in an **adaptive** manner, developing a targeted response for each invader encountered. The **innate immune system** defends against infection in a nonspecific manner. It contains a variety of cells such as phagocytes, neutrophils, natural killer cells, and others that will be discussed in [Chapter 54](#).

Immunoglobulins Are Comprised of Multiple Polypeptide Chains

Immunoglobulins are oligomeric glycoproteins whose individual subunits traditionally have been classified as heavy (H) or light (L) based on their migration during SDS-polyacrylamide gel electrophoresis. Human immunoglobulins can be grouped into five classes abbreviated as IgA, IgD, IgE, IgG, and IgM ([Table 52–8](#)). Their respective biologic functions are summarized in [Table 52–9](#). The most abundant of the five, IgG, consists of two identical light chains (23 kDa) and two identical heavy chains (53-75 kDa) linked together by a network of disulfide bonds.

TABLE 52–8 Properties of Human Immunoglobulins

Property	IgG	IgA	IgM	IgD	IgE
Percentage of total immunoglobulin in serum (approximate)	75	15	9	0.2	0.004
Serum concentration (mg/dL) (approximate)	1000	200	120	3	0.05
Sedimentation coefficient	7S	7S or 11S ^a	19S	7S	8S
Molecular weight (x1000)	150	170 or 400 ^a	900	180	190
Structure	Monomer	Monomer or dimer	Monomer or pentamer	Monomer	Monomer
H-chain symbol	γ	α	μ	δ	ϵ
Complement fixation	+	—	+	—	—
Transplacental passage	+	—	—	?	—
Mediation of allergic responses	—	—	—	—	+
Found in secretions	—	+	—	—	—
Opsonization	+	—	— ^b	—	—
Antigen receptor on B cell	—	—	+	?	—
Polymeric form contains J chain	—	+	+	—	—

TABLE 52–9 Major Functions of Immunoglobulins

Immunoglobulin	Major Functions
IgG	Main antibody in the secondary response. Opsonizes bacteria, making them easier to phagocytose. Fixes complement, which enhances bacterial killing. Neutralizes bacterial toxins and viruses. Crosses the placenta.
IgA	Secretory IgA prevents attachment of bacteria and viruses to mucous membranes. Does not fix complement.
IgM	Produced in the primary response to an antigen. Fixes complement. Does not cross the placenta. Antigen receptor on the surface of B cells.
IgD	Found on the surfaces of B cells where it acts as a receptor for antigen.
IgE	Mediates immediate hypersensitivity by causing release of mediators from mast cells and basophils upon exposure to antigen (allergen). Defends against worm infections by causing release of enzymes from eosinophils. Does not fix complement. Main host defense against helminthic infections.

The type of H chain determines the class of immunoglobulin and thus its effector function (see below): α (IgA), δ (IgD), ϵ (IgE), γ (IgG), and μ (IgM). The γ chains of IgG are organized into four conserved domains: an

amino-terminal variable region (V_H) and three **constant regions (CH1, CH2, CH3)**. The five types of H chains are distinguished by differences in their **CH regions**. The μ and ϵ chains each have four C_H domains rather than the usual three. The Y-shaped configuration of the immunoglobulin core unit is illustrated by the IgG heterotetramer (L_2H_2) shown in **Figure 52–11**. Some immunoglobulins such as IgG exist only as the basic tetramer. Others such as IgA and IgM can form higher oligomers comprised of two, three (IgA), or five (IgM) copies of the core tetrameric unit (**Figure 52–12**).

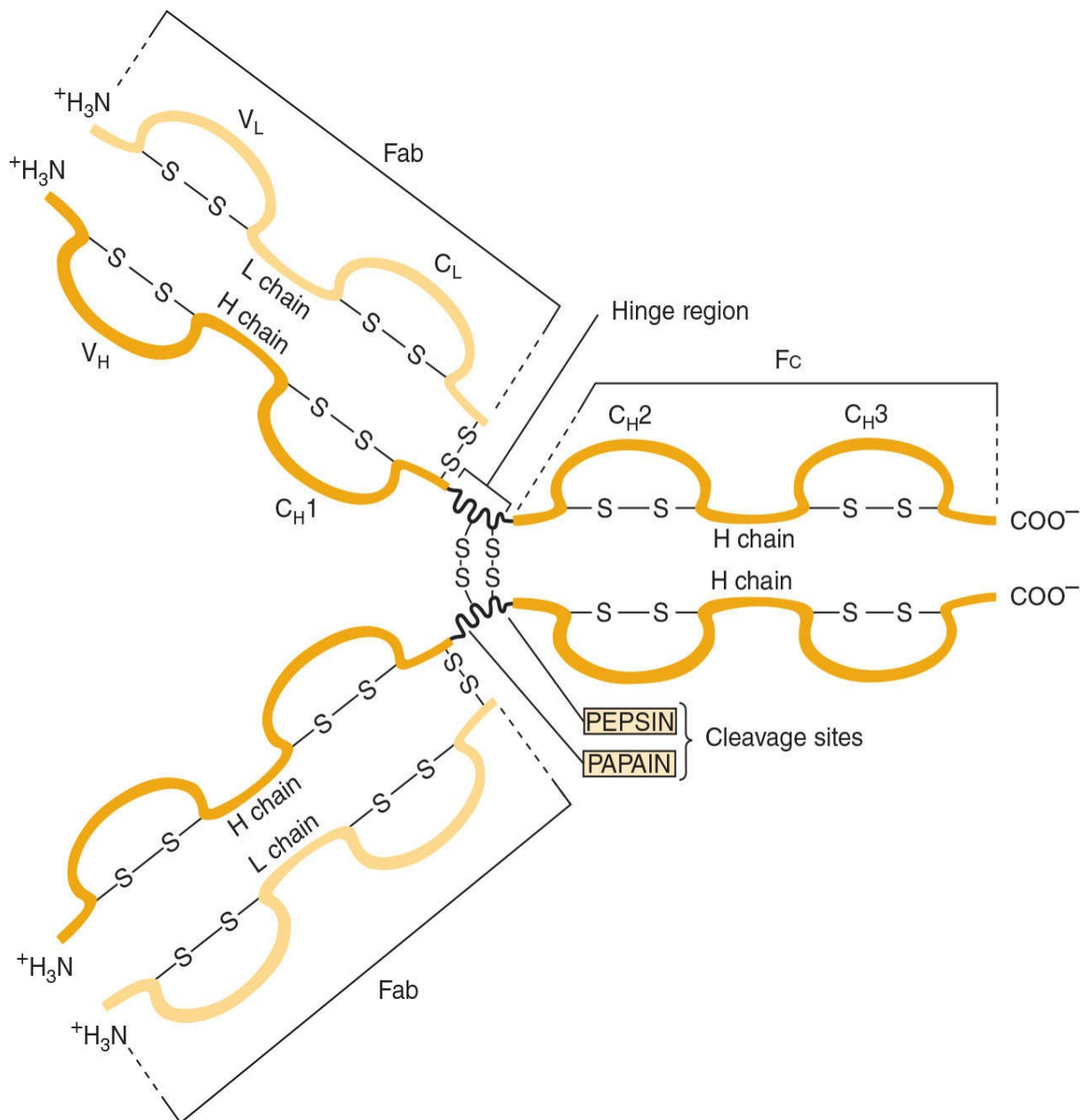

FIGURE 52–11 Structure of IgG. The molecule consists of two light (L)

chains and two heavy (H) chains. Each light chain consists of a variable (V_L) and a constant (C_L) region. Each heavy chain consists of a variable region (V_H) and a constant region that is divided into three domains (C_{H1} , C_{H2} , and C_{H3}). The C_{H2} domain contains the complement-binding site and the C_{H3} domain contains a site that attaches to receptors on neutrophils and macrophages. The antigen-binding site is formed by the hypervariable regions of both the light and heavy chains, which are located in the variable regions of these chains (see [Figure 52–13](#)). The light and heavy chains are linked by disulfide bonds, and the heavy chains are also linked to each other by disulfide bonds. (Reproduced, with permission, from Parslow TG, et al (editors): *Medical Immunology*, 10th ed. McGraw-Hill, 2001.)

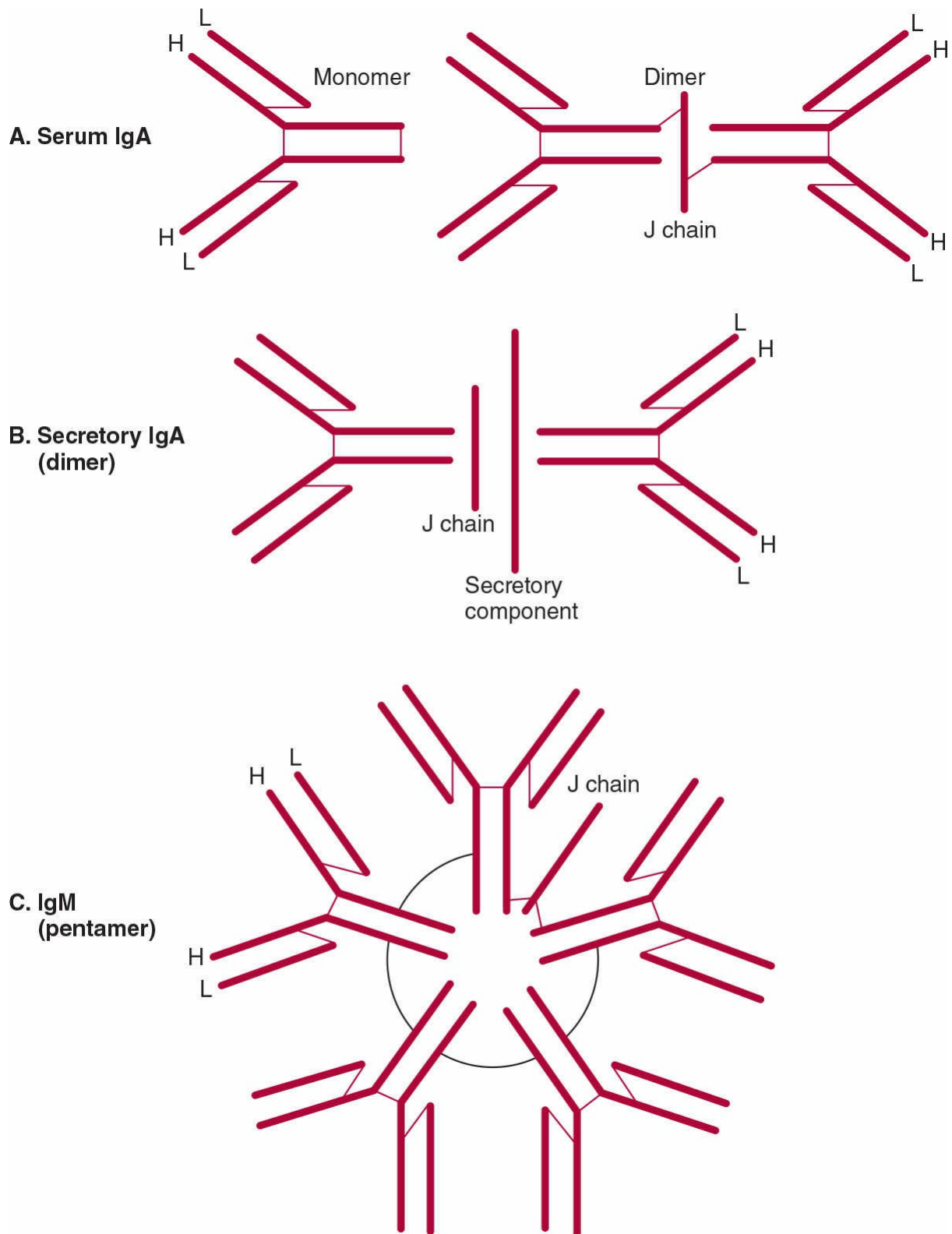

FIGURE 52–12 Schematic representation of serum IgA, secretory IgA, and IgM. Both IgA and IgM have a J chain, but only secretory IgA has a secretory component. Polypeptide chains are represented by thick lines; disulfide bonds linking different polypeptide chains are represented by thin lines. (Reproduced, with permission, from Parslow TG, et al

(editors): *Medical Immunology*, 10th ed. McGraw-Hill, 2001.)

The IgG light chain can be divided into a C-terminal **constant region (CL)** and amino-terminal **variable region (V_L)**. There are two general types of light chains, **kappa (κ)** and **lambda (λ)**, which can be identified by their distinct C_L regions. In human immunoglobulins, κ chains are more common than λ chains. A given immunoglobulin molecule always contains either two κ or two λ light chains—never a mixture of a κ and a λ.

IgG molecules are **divalent**. The tip of each Y contains an antigen-binding site made up of V_H and V_L domains that form two antiparallel sheets of amino acids. The site on the antigen to which an antibody binds is termed an **antigenic determinant**, or **epitope**. Because the region between the C_H1 and C_H2 domains can be readily cleaved by pepsin or papain ([Figure 52–11](#)), it is referred to as the hinge region. The hinge region confers **flexibility** to the Fab arms, which facilitates binding to **epitopes** that may be far apart or on two separate antigens. By linking antigen particles together, large antibody-antigen clusters form that are readily recognized for disposal by phagocytic leukocytes. Cluster formation is often demonstrated in the laboratory by the formation of erythrocyte **rosettes**.

Variable Regions Confer Binding Specificity

The **variable regions** of the immunoglobulin light and heavy chains form the **antigen-binding sites** that confer antibodies with their amazing specificity. Within the variable regions of the L and H chains are a handful of **hypervariable regions**, short (5-10 residue) islands interspersed within the relatively invariable **framework** or **complementarity-determining regions (CDRs)** ([Figure 52–13](#)). An antigen-binding site is formed when the **hypervariable regions** of an H and L chain align together to form a projecting loop from the antibody surface. As their name implies, no two variable regions in the immunoglobulins from different individuals share the same amino acid sequence.

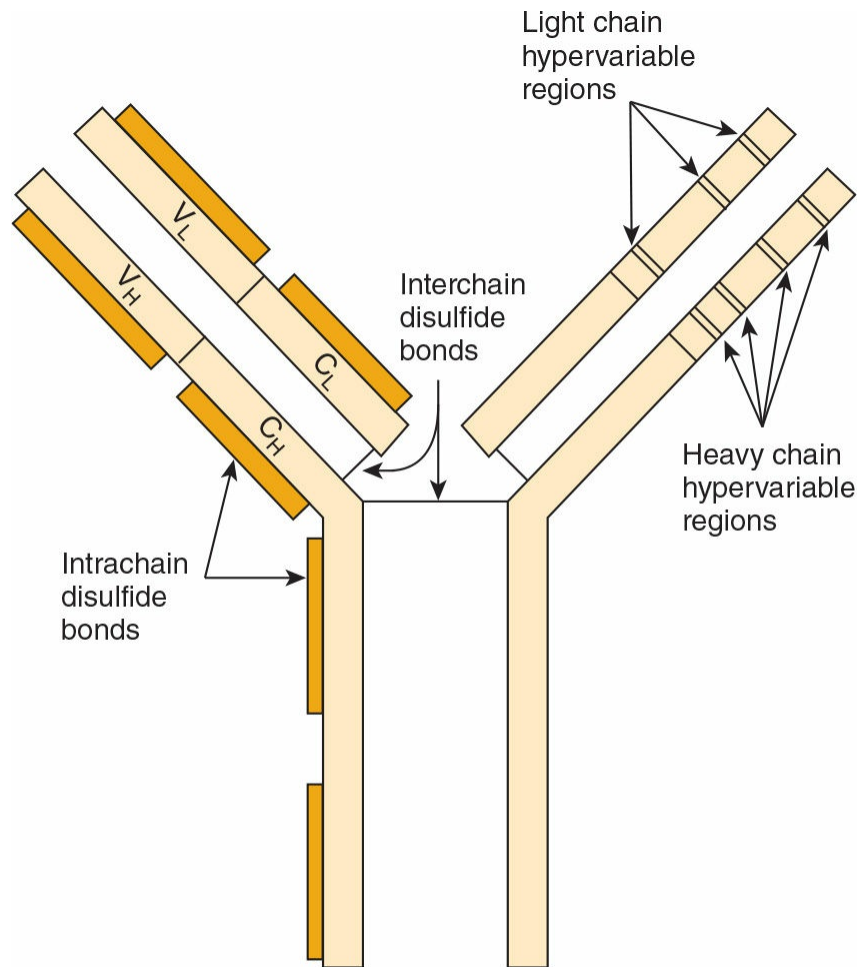

FIGURE 52–13 Schematic model of an IgG molecule showing approximate positions of the hypervariable regions in heavy and light chains. The antigen-binding site is formed by these hypervariable regions. The hypervariable regions are also called complementarity-determining regions (CDRs). (Modified and reproduced, with permission, from Parslow TG, et al (editors): *Medical Immunology*, 10th ed. McGraw-Hill, 2001.)

The capacity to generate various combinations of H and L chain CDRs provides a mechanism for producing **combinatorial diversity**, a collection of antibodies possessing different specificities. The essence of antigen-antibody interactions is **mutual complementarity** between the surfaces of CDRs and epitopes that involve multiple **noncovalent** interactions such as hydrogen bonding, salt bridges, hydrophobic interactions, and van der Waals forces (see [Chapter 2](#)).

The Constant Regions Determine Class-Specific Effector Functions

The **constant regions** of the immunoglobulin molecules, particularly C_H2 and C_H3 (and C_H4 of IgM and IgE) on the Fc fragment, are responsible for the **class-specific effector functions** of the different immunoglobulin molecules (Table 52–9, bottom part), such as complement fixation or transplacental passage.

Antibody Diversity Depends on Gene Rearrangements

The human genome contains fewer than 150 immunoglobulin genes. Nevertheless, each person is capable of synthesizing perhaps 1 million different antibodies, each specific for a unique antigen. Clearly, immunoglobulin expression does not follow the “one gene, one protein” paradigm. Instead, immunoglobulin diversity is generated by **combinatorial mechanisms** based on mixing and rearranging a finite pool of genetic information in multiple ways (see Chapters 35 and 38).

Antibody diversity arises, in part, from the distribution of the coding sequence for each immunoglobulin chain among multiple genes. Each light chain is the product of three or more separate structural genes that code for the **variable region (VL)**, **joining region (J)** (bearing no relationship to the J chain of IgA or IgM), and **constant region (CL)**. Similarly, each heavy chain is the product of at least **four** different genes that code for a **variable region (VH)**, a **diversity region (D)**, a **joining region (J)**, and a **constant region (CH)**. Each gene is present in the human genome in several versions that can be assembled in a multiplicity of combinations.

Diversity is further augmented through the action of the **activation-induced cytidine deaminase (AID)**. By catalyzing the conversion of cytidine to uracil, AID massively increases the frequency of mutation of immunoglobulin V genes. AID-generated mutations are **somatic** in nature, unique to the differentiated cell where they occurred rather than to a germline cell. Consequently, activation of AID can generate unique subpopulations of B cells that harbor distinct mutations of their V genes, causing each to synthesize immunoglobulins of differing antigen specificity. In some pathologic states, the mutagenic action of AID can lead to the generation of **autoantibodies** that target the body’s endogenous components, a phenomenon termed **autoimmunity**.

A third mechanism for synthesizing antibodies that target novel antigens is **junctional diversity**. This refers to the addition or deletion of

random numbers of nucleotides that takes place when certain gene segments are joined together. As is the case with AID, the mutations generated by junctional diversity are somatic in nature.

Class (Isotype) Switching Occurs During Immune Responses

In most humoral immune responses, antibodies of different classes are generated that target the same epitope. Each class appears in a specific chronologic order following exposure to an immunogen (immunizing antigen). For instance, antibodies of the IgM class normally precede the appearance of the IgG class. The transition from the synthesis of one class to another is designated **class** or **isotype switching**. Switching involves the combining of a given immunoglobulin light chain with different heavy chains. Whereas a newly synthesized light chain will initially be mated with a μ chain to generate a specific IgM molecule, over time the same antigen-specific light chain will be mated with a γ chain to generate an IgG whose V_H region and, consequently, antigen specificity will be identical to that of the μ chain of the preceding IgM molecule. Combining this light chain with an α heavy chain, in turn, forms an IgA molecule with identical antigen specificity. Immunoglobulin molecules of different classes that possess identical hypervariable and variable domains, and antigen specificity are said to share a common **idiotype**.

Monoclonal Antibodies Are an Important Research Tool

Antibodies have emerged as a major tool in biomedical research, diagnosis, and treatment. Originally, the production of antibodies against a selected antigen required that the antigen be injected into a host animal, such as a rabbit or goat, and serum-containing plasma immunoglobulins that included (hopefully) antibodies against the antigen of interest obtained. When an antigen is injected into an animal, a mixture of B cells is induced to synthesize antibodies directed against epitopes on the antigen. Antibodies produced are thus heterogeneous or **polyclonal** in nature. Moreover, unless subjected to costly affinity purification, the serum will contain all antibodies produced by the host animal in addition to those against the antigen of interest.

Homogenous **monoclonal** antibodies that target, not just a single antigen, but a single epitope on its surface can be generated by isolating B

cells from the spleen of a mouse (or another suitable animal) that has been previously injected with antigen. The cultured B cells are fused with mouse **myeloma cells** to generate an immortalized **hybridoma** cell line that secretes a single, monoclonal antibody. These antibodies are then screened to identify hybridoma lines that secrete a monoclonal antibody specific for the antigen or even the epitope of choice.

For therapeutic applications, monoclonal antibodies produced by murine cell lines can be **humanized**. This is accomplished by attaching the CDRs (the sites that bind antigens) onto appropriate sites in a human immunoglobulin molecule. This produces an antibody that is very similar to a human antibody, markedly reducing its **immunogenicity** and thus diminishing the chances of an anaphylactic reaction.

THE COMPLEMENT SYSTEM ALSO PROTECTS AGAINST INFECTION

Immunoglobulins form the core of the body's **adaptive immune system**, a name that reflects its ability to generate antibodies against novel infectious agents. The **innate immune system** derive its names from the fact that the number, function, and specificity of its components are fixed and remain constant throughout life. The plasma-borne arm of the innate immune system is called the **complement system**, which can be activated by antibody-antigen complexes and thus acts consequent to and in support of or as a complement to the adaptive immune system.

The complement system displays features reminiscent of the blood's coagulation cascade. Both consist of sets of circulating zymogens (proteins) that remain catalytically dormant until activated by proteolytic cleavage. These proteins, called **complement factors**, are synthesized by a variety of cell types, including hepatocytes, macrophages, monocytes, and intestinal endothelial cells. As is the case for clotting factors, most complement factors are propeptases (see [Chapter 9](#)) that, upon activation, target other components of the system, thereby generating a series or **cascade** of proteolytic activation events that amplify the production of the system's protective end products.

The **classical pathway** for activating the complex system is triggered when an antibody-antigen complex binds to and stimulates the protease activity of factor **C1**. C1 then cleaves complement factor C2 to form two smaller proteins, C2a and C2b, and cleaves complement factor C4 to form C4a and C4b ([Figure 52–14](#)). Two of the proteolytic fragments, C2a and C4b then associate together to form a new protease, the C3 convertase,

which cleaves complement factor C3 into C3a and C3b. C3a now binds with the C2a:C4b heterodimer to form a heterotrimeric complex, the C5 convertase, that cleaves complement factor C5 into C5a and C5b. The C5b protein then combines with complement factors C6, C7, C8, and C9 to form the **membrane attack complex (MAC)**. MAC kills bacterial invaders by binding to and opening a pore in their plasma membrane. Following lysis, the bacterial remains are destroyed by phagocytic macrophages. Meanwhile, the C3a and C5a proteins serve as chemoattractants that recruit leukocytes to the site of infection and stimulate an inflammatory response.

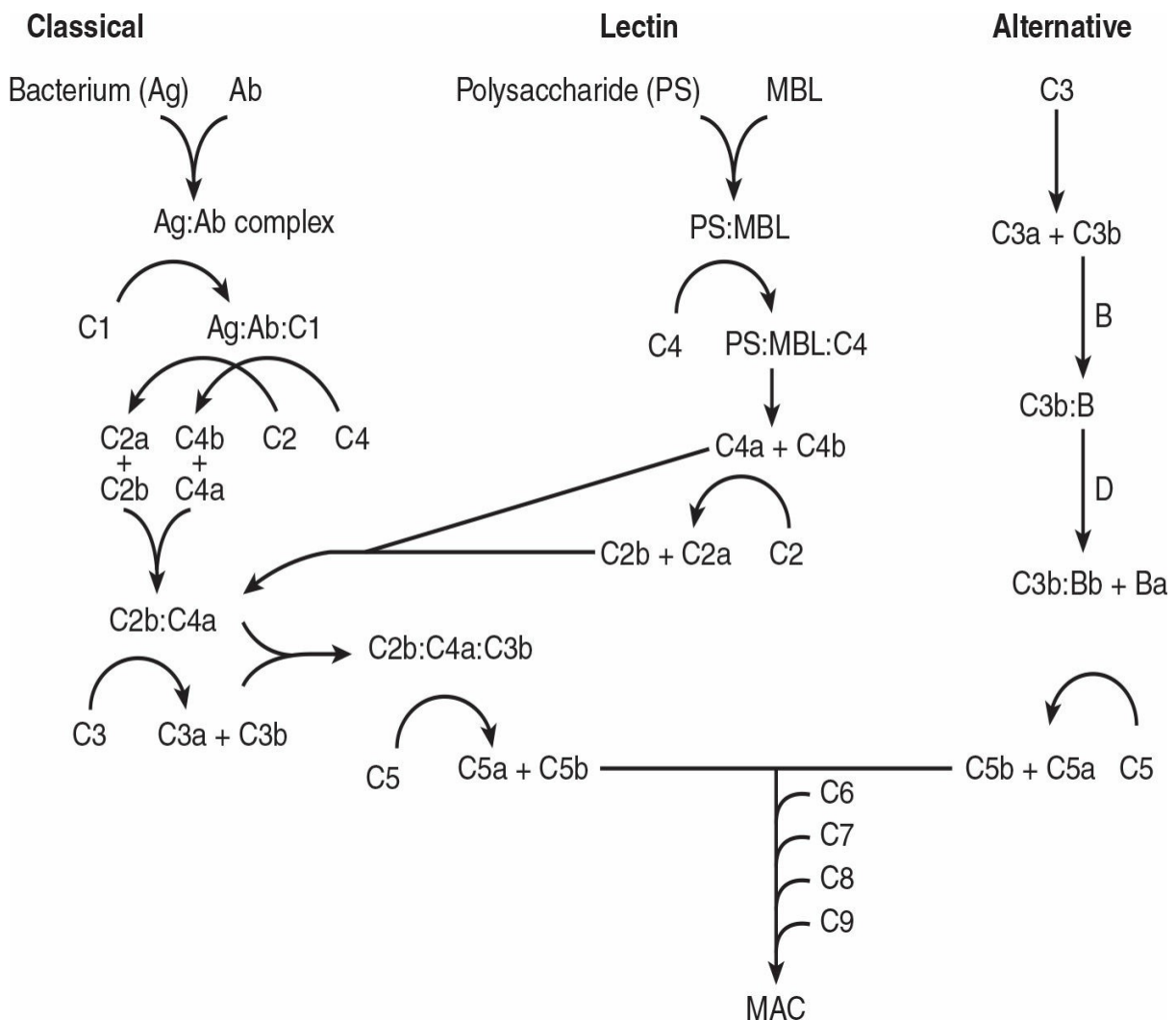

FIGURE 52–14 The complement cascade. Activation of the complement system can occur via three different mechanisms, referred to as the classical, lectin, and alternative pathways. Shown are the major components involved in each pathway, the products formed by proteolytic cleavage of the inactive proproteins, and the major complexes formed. Colons are used to indicate association in a complex.

Targeting of the MAC to invading bacteria is facilitated by the presence of thioester bonds in C3 and C4. Like the thioester bond in the plasma protease inhibitor α_2 -macroglobulin, this highly reactive bond becomes exposed as a result of the conformational change that accompanies activation. In the case of C3 and C4, the thioester reacts with the hydroxyl groups of the bacteria's surface polysaccharides, covalently anchoring the C5 convertase complex of which they are a part to the targeted pathogen. This enables the remaining components of the MAC to be formed in close proximity to the bacterial membrane, facilitating assembly.

Activation can also be triggered via the **lectin pathway**, wherein the complexes formed when a complement factor known as **mannose-binding lectin** (MBL), also called **mannan-binding protein** (MBP), binds bacterial polysaccharides to generate a complex that recruits and activates C4 (Figure 52–14). The term **lectin** refers to any protein that binds polysaccharides. Most lectins are highly selective. MBL is specific for the mannose-containing carbohydrate moieties (**mannans**) of glycoproteins and **lipopolysaccharides** present on the surface of gram-positive bacteria, some viruses, and several fungi. Upon binding to the polysaccharide-MBL complex, C4 undergoes autoproteolysis, releasing C4a and C4b. In addition, C4 cleaves C2 into C2a and C2b. The remainder of cascade mirrors that for the classical pathway.

MBL circulates as large, ≈ 400 to 700 kDa, multivalent complexes consisting of four or more copies of a homotrimeric core unit made up of three copies of a ≈ 30 -kDa polypeptide. The core of the homotrimer is formed when the amino-terminal collagen-like domains in these polypeptides intertwine to generate an extended tail. The globular head of each polypeptide contains a carbohydrate-binding domain. Once formed, four or more homotrimers associate together, covalently linked by disulfide bonds between their amino-terminal tail regions, to form a “stalk” from which each of the C-terminal carbohydrate-binding heads projects in a branched arrangement resembling that of an immunoglobulin (Figure 52–15).

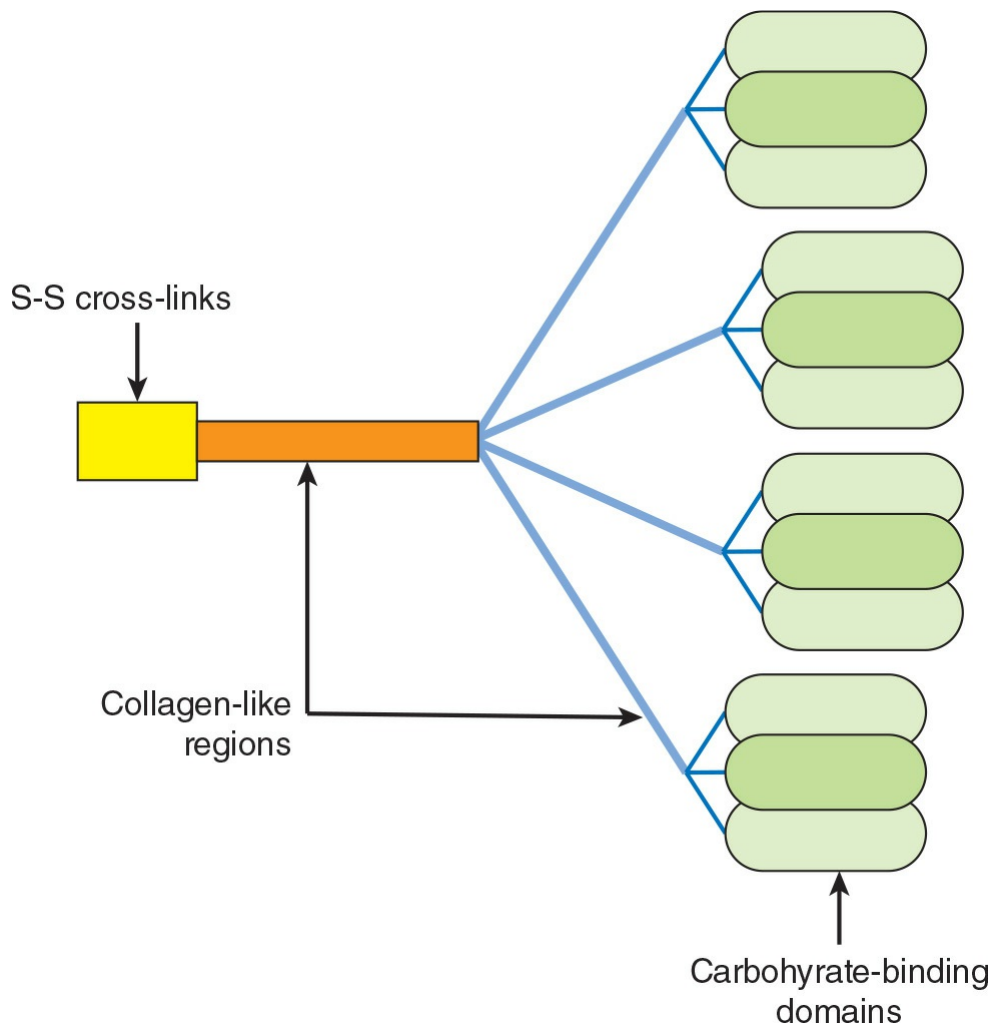

FIGURE 52–15 Schematic representation of mannose-binding lectin (MBL). Shown is a schematic diagram of a MBL comprised of four sets of MBL homotrimers. The carbohydrate-binding domains are colored green. The intertwined collagen-like binding domains for each trimer are shown in blue. The stalk region, where the amino-terminal portions of the homotrimers of collagen-like domains associate together, is colored orange and yellow, with yellow marking the region where the S—S cross-links that stabilize the tetramer of homotrimers are located.

The complement system also can be activated by the **alternative pathway**, in which C3 is activated by direct chemical hydrolysis, a process sometimes referred to as “ticking over.” In the alternative pathway, C3b binds complement factor B, forming a C3b:B complex that is then cleaved by complex factor D. The resulting C3b:Bb complex possesses C5 convertase activity.

DYSFUNCTIONS OF THE IMMUNE SYSTEM

CONTRIBUTE TO MANY PATHOLOGIC CONDITIONS

Dysfunctions of the innate and adaptive immune systems can have serious physiologic consequences. Deficits in the production of immunoglobulins or complement factors can leave the affected, **immunocompromised** individual susceptible to the occurrence and spread of bacterial, fungal, or viral infections. Many factors can contribute to a depression in the effectiveness of the immune system. These include genetic abnormalities (eg **agammaglobulinemia**, in which production of IgG is markedly affected), toxins, viral infections, malnutrition, neoplastic transformation, or treatment with immunosuppressant drugs.

Overproduction and precocious activation of the immune and complement systems can also be deleterious. Failure to differentiate host cells from a foreign invader can trigger an **autoimmune response** in which the body's immune system attacks its own tissues and organs. The resulting damage may be cumulative, such as occurs in rheumatoid arthritis and multiple sclerosis, or acute, such as the complete destruction of pancreatic islet cells that occurs in type 1 diabetes. In North America, autoimmune disorders affect three in every hundred persons.

[Table 52–1](#) lists several of the more commonly encountered autoimmune disorders.

SUMMARY

- Most plasma are synthesized in the liver. The majority are glycosylated.
- Albumin accounts for roughly 60%, by mass, of the protein content of plasma. As such, it is the principal determinant of intravascular osmotic pressure. Albumin also binds to and transports fatty acids, bilirubin, metal ions, and certain drugs.
- Haptoglobin binds extracorporeal hemoglobin to prevent its escape into the kidney, preventing the formation of damaging precipitates in the tubules.
- Ferritin binds to and stores ferric iron inside cells.
- Transferrin transports iron to the sites where it is required.
- Ceruloplasmin, the major copper-containing protein in plasma, is a ferroxidase that plays a key role in recycling the iron released when senescent red blood cells are destroyed.
- Heparin regulates iron homeostasis by blocking internalization of the

cellular iron export protein, ferrocidin.

- Heparin expression is stimulated when binding of transferrin-iron complexes to type 1 transferrin receptors displaces HFE protein, which then binds to and activates type 2 transferrin receptors.
- Hereditary hemochromatosis is a genetic disease involving excessive absorption of iron.
- α_1 -Antitrypsin is the major serine protease inhibitor of plasma. Genetically produced deficiencies of this protein can lead to emphysema and liver disease.
- α_2 -Macroglobulin is a major plasma protein that neutralizes many proteases and targets select cytokines to specific organs.
- Humans can synthesize immunoglobulins that specifically target millions of different antigens.
- The core structure of the immunoglobulins is a tetramer consisting of two light and two heavy chains arranged in a “Y” configuration.
- Synthesis of diverse antibodies from a limited set of genes is made possible by combining, rearranging, and somatic mutation of immunoglobulin genes.
- The ability to synthesize antibodies against novel antigens represents the defining feature of the adaptive immune system.
- Hybridoma cells can provide monoclonal antibodies for laboratory and clinical use.
- The complement system is generally activated by complexes formed between infecting microbes and protective antibodies or between mannose-rich polysaccharides on the pathogen’s surface and mannose-binding protein.
- The complement system is activated by a series of proteolytic cleavage events that transform dormant zymogens into active proteases.
- Autoimmune disorders result when the immune system attacks our body’s own tissues.

REFERENCES

- Burtis CA, Ashwood EA, Bruns DE (editors): *Tietz Textbook of Clinical Chemistry and Molecular Diagnostics*, 4th ed. Elsevier Saunders, 2006.
- Carroll MV, Sim RB: Complement in health and disease. *Adv Drug Disc Rev* 2011;63:965.
- Craig WY, Ledue TB, Ritchie RF: *Plasma Proteins: Clinical Utility and*

- Interpretation*. Foundation for Blood Research, 2008.
- Hentz MW, Muckenthaler MU, Gali B, et al: Two to tango: regulation of mammalian iron metabolism. *Cell* 2010;142:24.
- Noris M, Remuzzi G: Overview of complement activation and regulation. *Sem Nephrol* 2013;33:479.
- Schaller H, Gerber S, Kaempfer U, et al: *Human Blood Plasma Proteins: Structure and Function*. Wiley, 2008.

Red Blood Cells

Peter J. Kennelly, PhD & Robert K. Murray, MD, PhD

OBJECTIVES

After studying this chapter, you should be able to:

- Understand the concept of stem cells and their importance.
- Explain why red blood cells are reliant on glucose for energy.
- Describe the roles of erythropoietin, thrombopoietin, and other cytokines in the production of red blood cells and platelets.
- Describe the enzyme systems that protect heme iron from oxidation and reduce methemoglobin.
- Identify the major components of the erythrocyte cytoskeleton.
- Summarize the causes of the major disorders affecting red blood cells.
- Describe the major function of erythrocyte band 3 protein.
- Explain the biochemical bases of the ABO blood group substances.
- List the major components contained in the dense granules and α -granules in platelets.
- Describe the molecular bases of immune thrombocytopenic purpura and von Willebrand disease.

BIOMEDICAL IMPORTANCE

The evolution of a diverse array of freely circulating blood cells was critical to the development of animal life. The packaging of hemoglobin and carbonic anhydrase inside specialized cells called **erythrocytes** greatly amplified the capacity of circulating blood to carry oxygen to and carbon dioxide away from peripheral tissues. **Anemia**, a deficiency in the level of circulating hemoglobin ($< 120\text{-}130\text{ g/L}$), compromises health by reducing the ability of the blood to supply tissues with adequate levels of oxygen. Anemia can arise from a variety of causes that include genetic abnormalities (eg, sickle cell trait, pernicious anemia), excessive bleeding, insufficiencies of dietary iron or vitamin B₁₂, or the lysis of red blood cells by invading pathogens (eg, malaria). **Platelets** help staunch the outflow of blood from damaged tissues. Deficits in platelet number or function increase a patient's vulnerability to hemorrhage by reducing the speed of formation and structural integrity of protective clots. As is the case for anemia, a low platelet count, known as **thrombocytopenia**, can be triggered by a range of factors that include bacterial infection, some medications including sulfa-containing antibiotics, or autoimmune reactions such as idiopathic thrombocytopenic purpura. Other pathophysiologic syndromes, such as **von Willebrand disease** and **Glanzmann thrombasthenia**, are caused by genetic mutations that impair platelet adherence or aggregation rather than their abundance.

RED BLOOD CELLS DERIVE FROM HEMATOPOIETIC STEM CELLS

Both red blood cells and platelets turn over at a relatively high rate. Hence, replacements are constantly being produced from precursor **stem cells**. Stem cells possess a unique capacity both to produce unaltered daughter cells (**self-renewal**) and to generate a diverse range of specialized cell types (**potency**). Thus, stem cells are considered to exist in an undifferentiated state. Stem cells may be **totipotent** (capable of producing all the cells in an organism), **pluripotent** (able to differentiate into cells of any of the three germ layers), **multipotent** (able to produce only cells of a closely related family), or **unipotent** (able to produce only one type of cell). Stem cells are also classified as **embryonic** or **adult**, the latter of which are more limited in their capacity to differentiate.

Differentiation of hematopoietic stem cells is regulated by a set of secreted glycoproteins called **cytokines**. **Stem cell factor** and several

colony-stimulating factors collaborate with interleukins 1, 3, and 6 to stimulate the proliferation of hematopoietic stem cells in the bone marrow and induce their differentiation into one of several myeloid cell types (**Figure 53–1**). **Erythropoietin** or **thrombopoietin** then directs myeloid progenitor cells to eventually differentiate into erythrocytes or platelets, respectively.

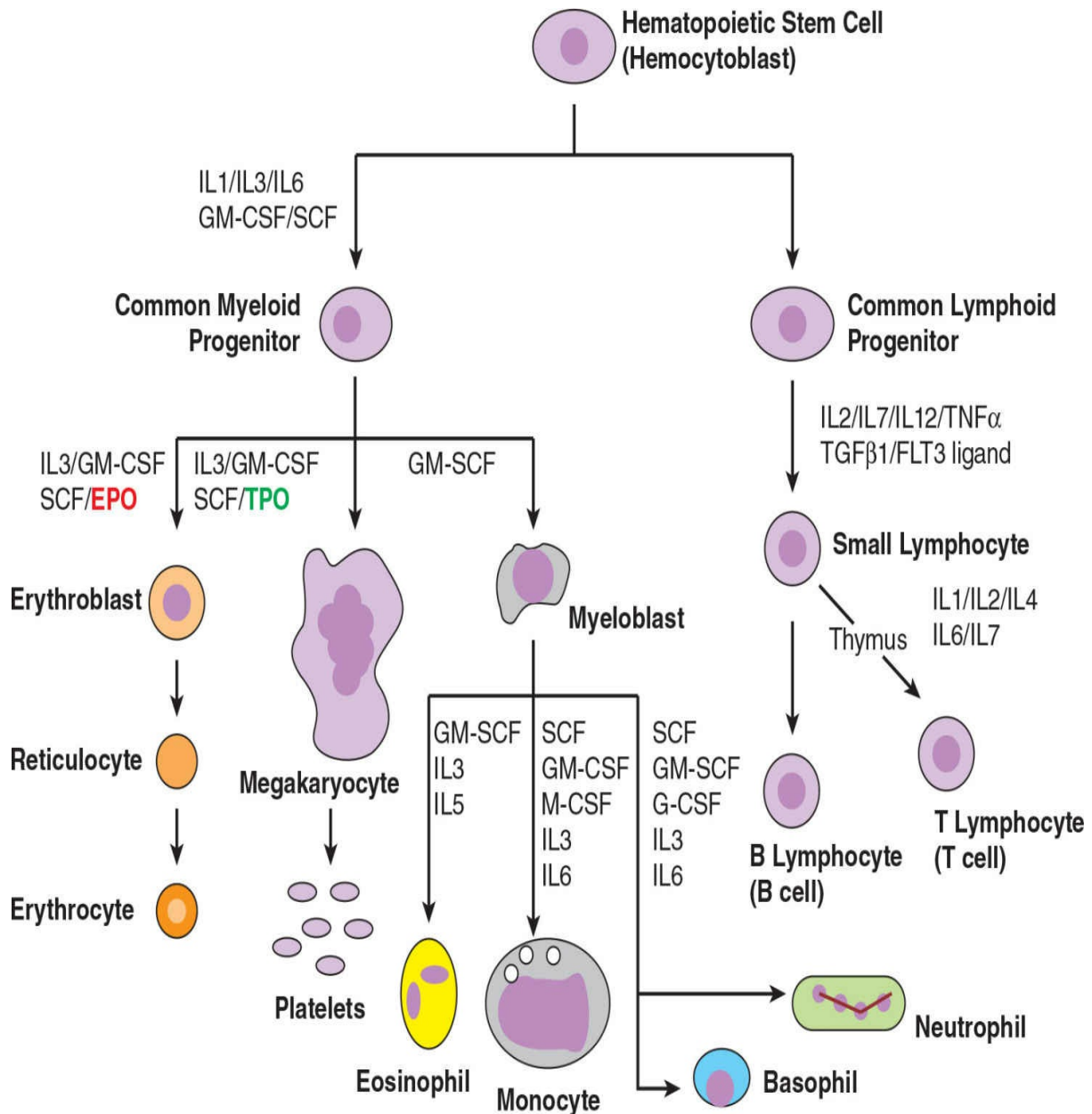

FIGURE 53–1 Hematopoiesis. Shown is a simplified and heavily abbreviated scheme indicating the paths by which hematopoietic stem cells differentiate to produce many of the more quantitatively prominent red and white blood cells. Only selected developmental intermediates are shown. The names for each cell type are indicated in **bold type**. Cell nuclei are

shown in **purple**. Each arrow summarizes a multistage transition. The hormones and cytokines that stimulate each transition are listed next to the arrows. EPO, erythropoietin; FLT3 ligand, FMS-like tyrosine kinase 3 ligand; G-CSF, granulocyte colony-stimulating factor; GM-CSF, granulocyte-macrophage colony-stimulating factor; IL, interleukin; M-CSF, macrophage colony-stimulating factor; SCF, stem cell factor; TGF- β_1 , transforming growth factor β_1 ; TNF- α , tumor necrosis factor α ; TPO, thrombopoietin.

RED BLOOD CELLS ARE HIGHLY SPECIALIZED

Mature Erythrocytes Are Devoid of Internal Organelles

The structure and composition of red blood cells reflect their highly specialized function: to deliver the maximum quantity of oxygen to tissues and aid in the removal of carbon dioxide, a waste product of cellular respiration, and urea. The interior of a red blood cell contains a massive amount of hemoglobin, roughly one-third by weight (30-34 g/dL for an adult). This extraordinary hemoglobin concentration is achieved, in part, by dispensing with the intracellular organelles normally found in eukaryotic cells (eg, nucleus, lysosome, Golgi apparatus, mitochondria). As a consequence, mature **enucleated** red blood cells are unable to reproduce.

Red blood cells possess an extensive cytoskeletal network responsible for maintaining their biconcave configuration (**Figure 53–2**). Their unusual shape enhances the exchange of oxygen and carbon dioxide between erythrocytes and tissues in two ways. First, their disc-like configuration possesses a much higher ratio of surface area to volume than more spherical shapes. Second, it enables red blood cells to fold over and squeeze through capillaries whose diameter is smaller than that of the erythrocyte itself. Both factors reduce the distance gas molecules must diffuse to and from the rapidly moving (up to 2 mm/s) erythrocytes.

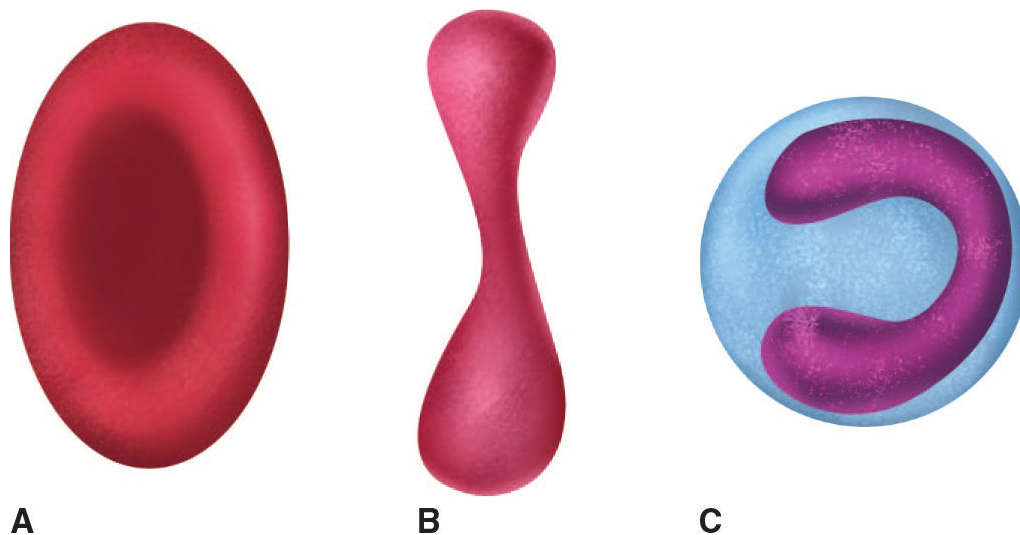

FIGURE 53–2 Red blood cells are shaped like biconcave disks. Shown are drawings of (A) a red blood cell, (B) a section through a red blood cell illustrating its biconcave shape, and (C) a red blood cell folded for passage through a narrow capillary.

Erythrocytes Generate ATP Exclusively via Glycolysis

Mature red blood cells lack the mitochondria that contain ATP synthase and the enzymes of the tricarboxylic acid cycle (TCA), electron transport chain, and β -oxidation pathway. They are therefore incapable of utilizing fatty acids or ketone bodies as metabolic fuel. Consequently, red blood cells are completely reliant of glycolysis to generate ATP. Glucose enters red blood cells by **facilitated diffusion** (see [Chapter 40](#)), a process mediated by **glucose transporter 1 (GLUT1)**, also known as glucose permease ([Table 53–1](#)).

TABLE 53–1 Some Properties of the Glucose Transporter of the Membrane of the Red Blood Cell (GLUT1)

- It accounts for ~2% of the protein of the membrane of the RBC.
- It exhibits specificity for glucose and related D-hexoses (L-hexoses are not transported).
- The transporter functions at ~75% of its V_{\max} at the physiologic concentration of blood glucose, is saturable, and can be inhibited by certain analogs of glucose.
- It is a member of a family of homologous glucose transporters found in mammalian tissues.
- It is not dependent upon insulin, unlike the corresponding carrier in muscle and adipose tissue.
- Its 492 amino acid sequence has been determined.
- It transports glucose when inserted into artificial liposomes.
- It is estimated to contain 12 transmembrane helical segments.
- It functions by generating a gated pore in the membrane to permit passage of glucose; the pore is conformationally dependent on the presence of glucose and can oscillate rapidly (~900 times/s).

The glycolytic pathway in red blood cells also possesses a unique branch, or shunt, whose purpose is to isomerize 1,3-bisphosphoglycerate (1,3-BPG) to **2,3-bisphosphoglycerate** (2,3-BPG). 2,3-BPG binds to and stabilizes hemoglobin in the T-state (see [Chapter 6](#)). Conversion of 1,3-BPG to 2,3-BPG is catalyzed by 2,3-BPG mutase, a bifunctional enzyme that also catalyzes the hydrolysis of 2,3-BPG to the glycolytic intermediate 3-phosphoglycerate. A second enzyme, multiple inositol polyphosphate phosphatase, also catalyzes the hydrolysis of 2,3-BPG to the glycolytic intermediate 2-bisphosphoglycerate. The activities of these enzymes are sensitive to pH, which ensures that 2,3-BPG levels rise and fall at the appropriate times during the oxygen transport cycle.

Various aspects of the metabolism of the red cell, several of which are discussed in other chapters, are summarized in [Table 53–2](#).

TABLE 53–2 Important Aspects of the Metabolism of the Red Blood Cell

- The RBC is highly dependent upon glucose as its energy source, for which its membrane contains high-affinity glucose transporters.
- Glycolysis, producing lactate, is the mode of production of ATP.
- Because RBCs lack mitochondria there is no production of ATP by oxidative phosphorylation.
- The RBC has a variety of transporters that maintain ionic and water balance.
- Production of 2,3-bisphosphoglycerate by reactions closely associated with glycolysis is important in regulating the ability of Hb to transport oxygen.
- The pentose phosphate pathway of the RBC metabolizes about 5%-10% of the total flux of glucose) and produces NADPH. Hemolytic anemia due to a deficiency of the activity of glucose-6-phosphate dehydrogenase is common.
- Reduced glutathione (GSH) is important in the metabolism of the RBC, in part to counteract the action of potentially toxic peroxides. The RBC can synthesize GSH and the NADPH required to return oxidized glutathione (G-S-S-G) to the reduced state GSH.
- The iron of Hb must be maintained in the ferrous state. Ferric iron is reduced to the ferrous state by the action of an NADH-dependent methemoglobin reductase system involving cytochrome b_5 reductase and cytochrome b_5 .
- While biosynthesis of glycogen, fatty acids, protein, and nucleic acids does not occur in the RBC, some lipids (eg, cholesterol) in the red cell membrane can exchange with corresponding plasma lipids.
- The RBC contains certain enzymes of nucleotide metabolism (eg, adenosine deaminase, pyrimidine nucleotidase, and adenylyl kinase). Deficiencies of these enzymes are involved in some cases of hemolytic anemia.
- When RBCs reach the end of their lifespan, the globin is degraded to amino acids (which are reutilized in the body), the iron is released from heme and reutilized, and the tetrapyrrole component of heme is converted to bilirubin, which is mainly excreted into the bowel via the bile.

Carbonic Anhydrase Facilitates CO₂ Transport

Like oxygen, the solubility of carbon dioxide in aqueous solution is low, much too low to accommodate more than a few percent of the CO₂ produced by metabolically active tissues. However, the solubility of the hydrated form of CO₂, carbonic acid (H₂CO₃) and its protonic dissociation product, bicarbonate (HCO₃⁻) is relatively high. The presence in erythrocytes of high levels of the enzyme **carbonic anhydrase** (see [Figure](#)

6–11) enables them both to absorb waste CO₂ by catalyzing its rapid conversion to carbonic acid, and to reverse this process in order to facilitate its expulsion in the lungs. While red blood cells carry some CO₂ in the form of hemoglobin-bound carbamates (see [Chapter 6](#)), roughly 80% is carried as dissolved carbonic acid and bicarbonate.

RED BLOOD CELLS MUST BE CONTINUALLY REPLACED

About Two Million Red Blood Cells Enter the Circulation per Second

The **120-day lifespan** of a normal red blood cell requires that nearly 1% of the 20 to 30 trillion erythrocytes in a typical individual must be replaced daily. This equates to a rate of production of ~ 2 million new red blood cells per second. When initially formed, differentiated red blood cells retain a portion of the ribosomes, endoplasmic reticulum, mitochondria, etc that were present in their nucleated precursors. Consequently, during the ~ 24 hours required to complete maturation to erythrocytes, these nascent red blood cells, called **reticulocytes**, retain the capacity to synthesize polypeptides (eg, globin) under the direction of vestigial mRNA molecules.

In rare cases, genetic mutations that lead to an impairment of ribosome function, called **ribomyopathies**, can result in red blood cell hypoplasia. **Diamond-Blackfan anemia** is caused by mutations in the gene encoding for the ribosomal processing protein RPS19. **5q-syndrome**, which presents a similar clinical picture, is caused by mutations that lead to an insufficiency of ribosomal protein RPS14.

Erythropoietin Regulates Production of Red Blood Cells

The initial stages of **erythropoiesis**, the production of red blood cells, are modulated by stem cell factor, colony-stimulating factors, and interleukins 1, 3, and 6. Commitment of myeloid progenitor cells to differentiation into erythrocytes is largely dependent on **erythropoietin (EPO)**, a glycoprotein of 166 amino acids (molecular mass ≈ 34 kDa). EPO, which is synthesized mainly by the kidney, is released into the bloodstream in response to hypoxia. Upon reaching the bone marrow, EPO stimulates red

blood cell progenitors via a transmembrane receptor. Binding of EPO to its receptor stimulates the dimerization of the receptor and activation of associated molecules of the Jak2 protein-tyrosine kinase.

Erythropoietin is administered therapeutically to treat anemias arising from chronic kidney failure, disorders of hematopoietic stem cells (**myelodysplasia**), or from the collateral effects of chemical and radiologic treatments for cancer. Today, recombinant DNA technology has made it possible to produce substantial amounts of erythropoietin from cultured human cells. As described in [Chapter 49](#), scientists are working to increase the dose effectiveness of recombinant EPO by manipulating the composition of its polysaccharide chains.

OXIDATION OF HEME IRON COMPROMISES OXYGEN TRANSPORT

Cytochrome b_5 Reductase Reduces Methemoglobin

The ferrous, Fe^{2+} , iron atoms in hemoglobin are susceptible to oxidation by **reactive oxygen species (ROS)**. Hemoglobin in which one or more heme irons has been oxidized to the ferric (Fe^{3+}) state is called **methemoglobin**. Ferric hemes do not bind oxygen, which not only reduces the number of O_2 -binding sites, but can interfere with the cooperative interactions between the subunits of the hemoglobin tetramer (see [Chapter 6](#)). The ability to rescue methemoglobin by reducing ferric iron is thus of great physiologic importance. In red blood cells, methemoglobin reduction is catalyzed by the NADH–cytochrome b_5 methemoglobin reductase system. The first component of the system, a flavoprotein named **cytochrome b_5** reductase (also known as methemoglobin reductase), transfers electrons from **NADH** to the second component, **cytochrome b_5** , using electrons supplied by NADH:

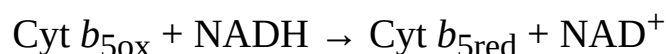

Reduced cytochrome b_5 then transfers the electrons to methemoglobin, reducing Fe^{3+} back to the Fe^{2+} state, thereby restoring hemoglobin to a fully functional state:

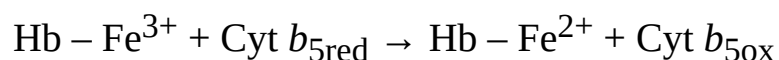

The ultimate source of the electrons used to reduce methemoglobin is glycolysis, where NAD^+ is reduced to NADH by the action of glyceraldehyde-3-phosphate dehydrogenase. The efficiency of this system is such that only trace quantities of methemoglobin are normally present in erythrocytes.

Methemoglobinemia Is Inherited or Acquired

Methemoglobinemia, the abnormal accumulation of methemoglobin, can arise from genetic abnormalities (inherited methemoglobinemia) or from the ingestion of certain drugs and chemicals (acquired methemoglobinemia) such as sulfonamides or aniline (**Table 53–3**). Affected patients often exhibit bluish discoloration of the skin and mucous membranes (cyanosis). The inherited form most commonly arises from a deficiency in the quantity or activity of **cytochrome *b*₅ reductase**, although mutations that affect the properties of cytochrome *b*₅ itself have also been encountered. In rare instances, methemoglobinemia can result from mutations in hemoglobin itself, such as those affecting the proximal and distal histidine residues (see **Figure 6–3**), that render it more susceptible to oxidation. Collectively referred to as hemoglobin M (HbM), these include HbM_{Iwate}, in which His87 in the α subunit is replaced by Tyr; HbM_{Hyde Park}, in which His92 of the β subunit is replaced by Tyr; HbM_{Boston}, in which His58 in the α subunits of hemoglobin is replaced by Tyr; and HbM_{Saskatoon}, in which His92 in the β subunit is replaced by Tyr. One exception to this pattern is HbM_{Milwaukee-1}, in which Val67 of the β subunit is replaced by Glu. All known carriers of HbM are heterozygotes.

TABLE 53–3 Summary of the Causes of Some Important Disorders Affecting Red Blood Cells

Disorder	Sole or Major Cause
Iron deficiency anemia	Inadequate intake or excessive loss of iron
Methemoglobinemia	Intake of excess oxidants (various chemicals and drugs) Genetic deficiency in the NADH-dependent methemoglobin reductase system (OMIM 250800) Inheritance of HbM (OMIM 141900)
Sickle cell anemia (OMIM 603903)	Sequence of codon 6 of the β chain changed from GAG in the normal gene to GTC in the sickle cell gene, resulting in substitution of valine for glutamic acid
α -Thalassemias (OMIM 141800)	Mutations in the α -globin genes, mainly unequal crossing-over and large deletions and less commonly nonsense and frameshift mutations
β -Thalassemias (OMIM 141900)	A very wide variety of mutations in the β -globin gene, including deletions, nonsense and frameshift mutations, and others affecting every aspect of its structure (eg, splice sites, promoter mutants)
Megaloblastic anemias	Deficiency of vitamin B ₁₂ . Decreased absorption of B ₁₂ , often due to a deficiency of intrinsic factor, normally secreted by gastric parietal cells Deficiency of folic acid. Decreased intake, defective absorption, or increased demand (eg, in pregnancy) for folate
Hereditary spherocytosis ^a (OMIM 182900)	Deficiencies in the amount or in the structure of α - or β -spectrin, band 3, or band 4.1.
Glucose-6-phosphate dehydrogenase (G6PD) deficiency ^a (OMIM 305900)	A variety of mutations in the gene (X-linked) for G6PD, mostly single-point mutations
Pyruvate kinase (PK) deficiency ^a (OMIM 266200)	A variety of mutations in the gene for the R (red cell) isozyme of PK
Paroxysmal nocturnal hemoglobinuria ^a (OMIM 311770)	Mutations in the PIG-A gene, affecting synthesis of GPI-anchored proteins

Superoxide Dismutase, Catalase, & Glutathione Protect Blood Cells From Oxidative Stress & Damage

The radical anion **superoxide**, O_2^- , is generated in red blood cells by the autoxidation of hemoglobin to methemoglobin. This potent ROS can react with and damage proteins, lipids, nucleotides, and other biomolecules (see [Chapter 58](#)). Approximately 3% of the hemoglobin of human blood undergoes auto-oxidation each day. In addition, oxidation of the iron storage protein ferritin by superoxide can result in the release of free Fe^{2+} and the subsequent iron-catalyzed generation of OH^\cdot (see [Figure 58–2](#)). Superoxide may thus produce the tissue damage that occurs in persons suffering from abnormally high levels of iron in the body, known as iron overload. Iron overload is characteristic of individuals suffering from

hereditary hemochromatosis, a genetic condition that causes the body to absorb excessive quantities of dietary iron. Another endogenous source of superoxide is the enzyme **NADPH-hemoprotein reductase** (a cytochrome P450 reductase, see [Chapter 12](#)), another enzyme that can catalyze the reduction of the Fe^{3+} in methemoglobin to Fe^{2+} .

Deficiency of Glucose-6-Phosphate Dehydrogenase Is an Important Cause of Hemolytic Anemia

The limited suite of metabolic pathways present in red blood cells renders them completely reliant on the **pentose phosphate pathway** (see [Chapter 20](#)) or, to be more specific, the X-linked enzyme **glucose-6-phosphate dehydrogenase** for the reduction of NADP^+ to NADPH. Glucose-6-phosphate dehydrogenase deficiency is the most common of all **enzymopathies** (diseases caused by abnormalities of enzymes). More than 400 million people are estimated to carry one of the over 140 genetic variants of glucose-6-phosphate dehydrogenase. This deficiency is most common among natives of tropical Africa (and their African-American descendants), the Mediterranean, and certain parts of Asia.

Individuals harboring this deficiency are vulnerable to attacks of hemolytic anemia, a consequence of their inability to generate sufficient NADPH to maintain glutathione, a key intracellular antioxidant, in the reduced state ([Figure 53–3](#)). A deficiency in glucose-6-phosphate dehydrogenase renders red blood cells hypersensitive to oxidative stress and ROS-induced the formation of **Heinz bodies**, insoluble aggregates consisting of hemoglobin molecules whose —SH groups have become oxidized, and which stain purple with cresyl violet. Like sickle cell trait, the persistence of these genetic variants has been attributed to their potential to confer enhanced resistance to malaria.

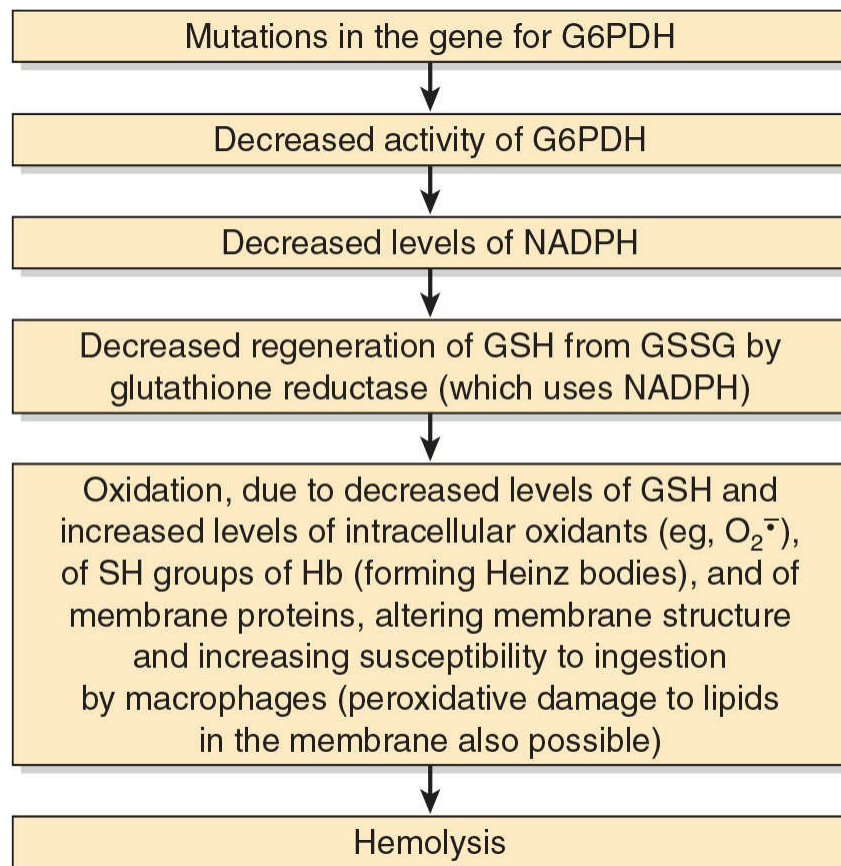

FIGURE 53–3 Summary of probable events causing hemolytic anemia due to deficiency of the activity of glucose-6-phosphate dehydrogenase (OMIM 305900).

Hemolytic Anemias Can Be Caused by Extrinsic, Intrinsic, or Membrane-Specific Factors

Hemolytic anemia can be triggered by factors other than a deficiency in glucose-6-phosphate dehydrogenase (**Figure 53–4**). **Extrinsic** causes (beyond the erythrocyte membrane) include **hypersplenism**, in which the enlargement of the spleen causes red blood cells to become sequestered within this organ. Erythrocytes also can lyse if attacked by incompatible antibodies present in intravenously administered plasma or blood (eg, **transfusion reaction**). Immunologic incompatibilities may arise when an Rh⁺ fetus is carried by an Rh⁻ mother (**Rh disease**) or as a consequence of an autoimmune disorder (eg, **warm** or **cold antibody hemolytic anemias**). Some infectious and toxic agents act by directly undermining the structural integrity of the erythrocyte membrane. For example, many insect and reptile venoms of various species contain phospholipases or proteases that catalyze the hydrolytic breakdown of membrane

components. Similarly, some infectious bacteria, including certain strains of *Escherichia coli* and clostridia, secrete lytic factors called **hemolysins**, which can be composed of proteins, lipids, or some combination thereof. Parasitic infections (eg, the plasmodia causing malaria) are also a major cause of hemolytic anemias in certain geographic areas.

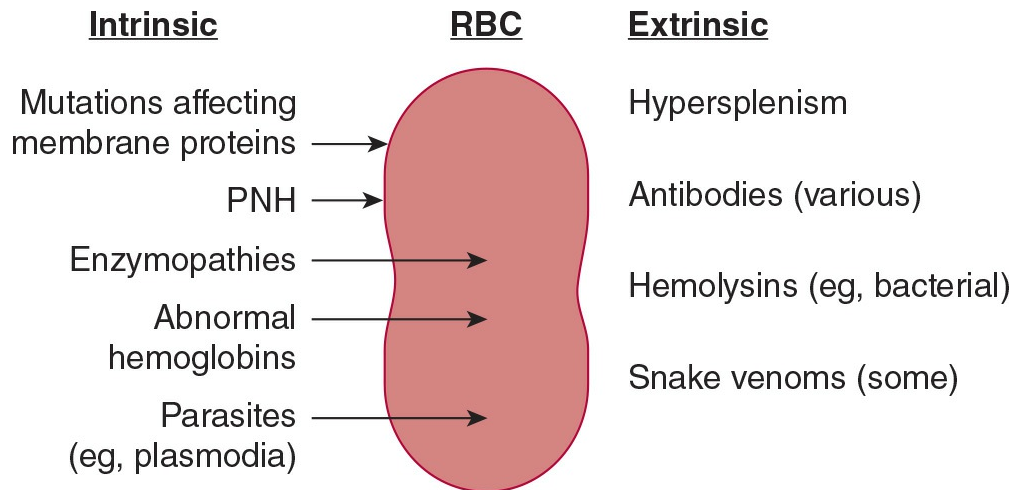

FIGURE 53–4 Schematic diagram of some causes of hemolytic anemias. Extrinsic causes include hypersplenism, various antibodies, certain bacterial hemolysins, and some snake venoms. Causes intrinsic to the red cells include mutations that affect the structures of membrane proteins (eg, in hereditary spherocytosis and hereditary elliptocytosis), paroxysmal nocturnal hemoglobinuria (PNH, see [Chapter 47](#)), enzymopathies, abnormal hemoglobins, and certain parasites (eg, plasmodia causing malaria).

The root cause of many hemolytic anemias is intracellular, also referred to as **intrinsic**. Glucose-6-phosphate dehydrogenase deficiency falls into this category. Defects in the composition or structure of hemoglobin, called **hemoglobinopathies**, constitute the second major intrinsic cause of hemolysis. Most hemoglobinopathies, such as sickle cell anemia and the various thalassemias (see [Chapter 6](#)), are genetic in nature. In rare cases, hemolytic anemia can arise from an insufficiency in the enzyme **pyruvate kinase**. The resulting impairment of glycolysis reduces the production of the ATP required to power the export of excess water and Na^+ . The resulting osmotic pressure (see below) can compromise and potentially overwhelm the integrity of the erythrocyte membrane.

Mutations that affect the cytoskeletal proteins responsible for maintaining their biconcave shape and resistance to osmotic pressure are classified as **membrane-specific** causes of hemolytic anemia (see below).

The most important of these are **hereditary spherocytosis** and **hereditary elliptocytosis**, which arise from abnormalities in the amount or structure of the cytoskeletal protein **spectrin**. Defects may also occur in the synthesis of the glycoposphatidylinositol groups that anchor certain proteins, such as acetylcholinesterase and decay-accelerating factor, to the surface of the erythrocyte membrane, as is the case in **paroxysmal nocturnal hemoglobinuria** (see [Chapter 46](#)).

THE RED BLOOD CELL MEMBRANE

Early analyses by **SDS-PAGE** of the polypeptides present in red blood cells revealed 10 major proteins ([Figure 53–5](#)). These proteins were initially assigned numeric designators based on their migration on SDS-PAGE. Thus, the polypeptide with the highest molecular mass, which migrates slowest, was designated band 1 protein, also known as **spectrin** ([Table 53–4](#)). As illustrated by [Figure 53–6](#), certain of these proteins are glycosylated. Several proteins span the membrane bilayer (integral membrane proteins), while others associate with its surface, generally via protein–protein interactions (peripheral membrane proteins).

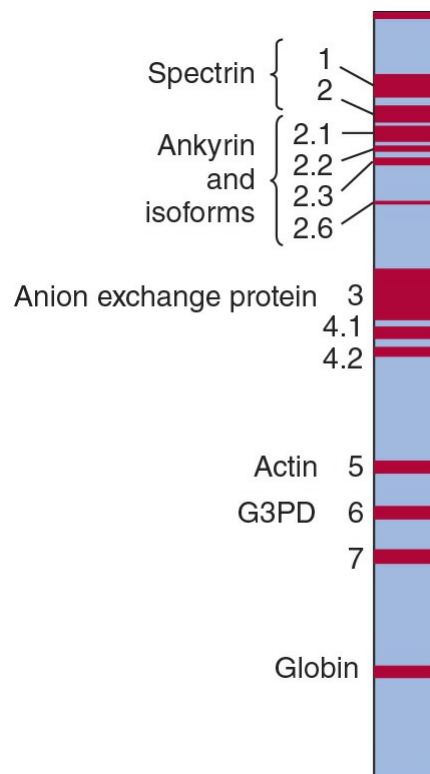

FIGURE 53–5 Major membrane proteins of the human red blood cell. Proteins separated by SDS-PAGE were detected by staining with Coomassie blue dye. (Reproduced, with permission, from Beck WS,

Tepper RI: Hemolytic anemias III: membrane disorders. In: *Hematology*, 5th ed. Beck WS (editor). The MIT Press, 1991.)

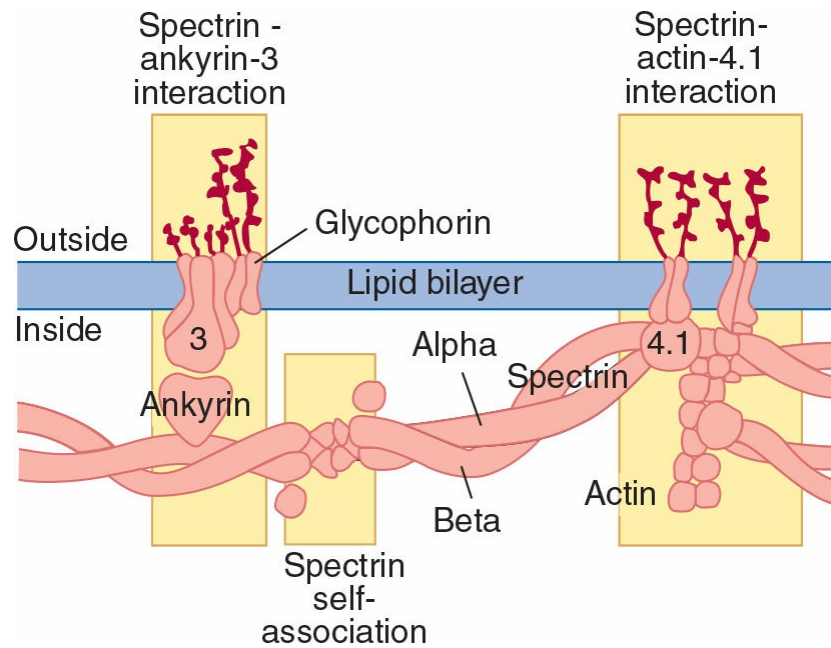

FIGURE 53–6 Interactions of cytoskeletal proteins with each other and with certain integral proteins of the membrane of the red blood cell. (Reproduced, with permission, from Beck WS, Tepper RI: Hemolytic anemias III: membrane disorders. In: *Hematology*, 5th ed. Beck WS (editor). The MIT Press, 1991.)

TABLE 53–4 Principal Proteins of the Red Cell Membrane

Band Number ^a	Protein	Integral (I) or Peripheral (P)	Approximated Molecular Mass (kDa)
1	Spectrin (α)	P	240
2	Spectrin (β)	P	220
2.1	Ankyrin	P	210
2.2	Ankyrin	P	195
2.3	Ankyrin	P	175
2.6	Ankyrin	P	145
3	Anion exchange protein	I	100
4.1	Unnamed	P	80
5	Actin	P	43
6	Glyceraldehyde-3-phosphate dehydrogenase	P	35
7	Troomyosin	P	29
8	Unnamed Glycophorins A, B, and C	P I	23 31, 23, and 28

The Red Blood Cell Membrane Contains Anion Exchange Protein & the Glycophorins

Band 3 protein is a **multipass** transmembrane glycoprotein whose polypeptide chain crosses the bilayer 14 times. Band 3 protein is oriented with its carboxyl terminal end projecting from the external surface of the erythrocyte membrane and its amino-terminal end from the cytosolic face. The principal function of this dimeric **anion exchange protein** is to provide a channel through the membrane via which chloride and bicarbonate anions can be exchanged. At the tissues, bicarbonate generated from the hydration of CO_2 is exchanged for chloride. At the lungs, where carbon dioxide is exhaled, this process is reversed. The amino-terminal end also serves as an anchoring point for several other red blood cell

proteins, including band 4.1 and 4.2 proteins, ankyrin, hemoglobin, and several glycolytic enzymes.

Glycophorins A, B, and C are **single-pass** transmembrane proteins (the polypeptide chain crosses the membrane only once). The single 23-amino acid transmembrane segment is α -helical in configuration. The predominant form, **glycophorin A**, is comprised of a 131-amino acid polypeptide covalently modified by 16 oligosaccharide chains, 15 of them O-linked, that account for roughly 60% of its mass and nearly 90% of the sialic acid residues exposed on the surface of the red cell membrane. The carboxyl-terminal end extends into the cytosol and binds to band 4.1 protein, which in turn binds to spectrin. **Polymorphism** of glycophorin A serves as the basis of the MN blood group system (see below). Some viral and bacterial pathogens, such as influenza virus and *Plasmodium falciparum*, target erythrocytes by recognizing and binding to glycophorin A. Intriguingly, individuals whose red cells lack glycophorin A exhibit no adverse effects.

Spectrin, Ankyrin, & Other Peripheral Membrane Proteins Help Determine the Shape & Flexibility of the Red Blood Cell

In order to maximize the efficiency of gas exchange, red blood cells must possess the structural strength to maintain their biconcave shape, yet remain sufficiently flexible to squeeze through peripheral capillaries and the sinusoids of the spleen. The structural foundation that molds and maintains the membrane's inherent fluid and deformable lipid bilayer into the erythrocyte's characteristic biconcave shape is provided by a strong but flexible network of **cytoskeletal proteins** (Figure 53–6).

Spectrin is the most abundant protein of the erythrocyte cytoskeleton. It is composed of two polypeptides more than 2100 residues in length: spectrin 1 (α chain) and spectrin 2 (β chain). The α and β chains of each spectrin dimer intertwine in an antiparallel orientation to form a highly extended structural unit \approx 100 nm in length. Normally, two spectrin dimers self-associate head-to-head to form an approximately 200-nm long heterotetramer that is linked to the inner surface of the plasma membrane (and is bridged to other spectrin tetramers) via ankyrin, actin, and band 4.1 protein. The result is an internal mesh, the cytoskeleton, that is strong enough to maintain cell shape and resist swelling due to osmotic pressure, yet flexible enough to allow the erythrocyte to fold when needed.

Ankyrin is a pyramid-shaped protein that **binds spectrin**. In turn, ankyrin binds tightly to band 3, securing attachment of spectrin to the membrane. Ankyrin is sensitive to proteolysis, accounting for the appearance of bands 2.2, 2.3, and 2.6, all of which are derived from band 2.1.

Actin (band 5) exists in red blood cells as short, double-helical filaments of F-actin. The tail end of spectrin dimers binds to actin. Actin also binds to **protein 4.1**. Protein 4.1 is a globular protein that binds tightly to a site near the actin-binding domain in the tail of spectrin to form a protein 4.1-spectrin-actin ternary complex. Protein 4.1 also binds to the integral membrane proteins glycophorin A and glycophorin C, as well as certain phospholipids, thereby anchoring the ternary complex to the membrane.

Certain other less quantitatively prominent proteins, such as band 4.9, adducin, and tropomyosin, also participate in **cytoskeletal assembly**.

Abnormalities in the Amount or Structure of Spectrin Cause Hereditary Spherocytosis & Elliptocytosis

Hereditary spherocytosis, a genetic disease transmitted as an autosomal dominant, is characterized by the presence of spherocytes (spherical red blood cells) in the peripheral blood, by **hemolytic anemia**, and by splenomegaly. Their abnormal shape, in turn, renders spherocytes less deformable and more prone to destruction in the spleen, thus greatly shortening their life in the circulation. This condition, which affects about 1 in 5000 persons of Northern European ancestry, is caused by a deficiency in the amount or abnormalities in the structure of **spectrin** or, less frequently, ankyrin or band 3, 4.1, or 4.2 proteins. Loss of these proteins or reductions in their capacity to associate with other cytoskeletal components weakens the links that anchor the erythrocyte membrane to the cytoskeleton, allowing the erythrocyte to swell into a spherical shape. The anemia associated with hereditary spherocytosis is generally relieved by surgical removal of the patient's spleen (**splenectomy**).

Hereditary elliptocytosis can readily distinguished from hereditary spherocytosis by virtue of the fact that the affected red blood cells assume an elliptic shape. This condition results from genetic abnormalities that affect **spectrin** or, less frequently, band 4.1 protein or glycophorin C.

THE BIOCHEMICAL BASIS OF THE ABO

SYSTEM

Approximately 30 human blood group systems have been recognized, the best known of which are the **ABO**, **Rh** (Rhesus), and **MN** systems. The term “**blood group**” refers to a defined set of red blood cell antigens, or blood group substances, controlled by a genetic locus having a variable number of alleles (eg, A, B, and O in the ABO system). The term “**blood type**” refers to the antigenic phenotype, usually recognized by the use of appropriate antibodies.

The ABO System Is of Crucial Importance in Blood Transfusion

The ABO system was discovered by Landsteiner in 1900 while investigating the basis of compatible and incompatible transfusions in humans. The membranes of the erythrocytes of most individuals contain one blood group substance, either type A, B, AB, or O. Individuals of **type A** have anti-B antibodies in their plasma that will agglutinate the erythrocytes in type B or type AB blood. Individuals of **type B** have anti-A antibodies that will agglutinate type A or type AB erythrocytes. **Type AB** blood has neither anti-A nor anti-B antibodies, and has been designated the **universal recipient**. **Type O** blood has neither A nor B antigens, and has been designated the **universal donor**. The above description has been simplified considerably, as further subgroups exist such as A₁ and A₂. The genes responsible for production of the ABO substances are present on the long arm of chromosome 9. There are **three alleles**, two of which are codominant (A and B) and the third (O) recessive; these ultimately determine which of the four phenotypic products is synthesized: the A, B, AB, and O substances.

The ABO Antigens Are Glycosphingolipids & Glycoproteins

The **ABO antigens** are complex oligosaccharides present in most cells of the body and in certain secretions (**Figure 53–7**). These oligosaccharides are bound to membrane proteins or lipids, and are collectively referred to as ABO substances. For red blood cells, the membrane oligosaccharides that determine the antigenic natures of the ABO substances appear to be mostly present in **glycosphingolipids**, whereas in secretions the same oligosaccharides are present in **glycoproteins**. Their presence in secretions

is determined by a gene designated **Se** (for secretor), which codes for a specific **fucosyl (Fuc) transferase** in secretory organs, such as the exocrine glands, but which is not active in red blood cells. Individuals of *SeSe* or *Sese* genotypes secrete either or both A and B antigens whereas individuals of the *sese* genotype do not. However, their red blood cells can express the A and B antigens.

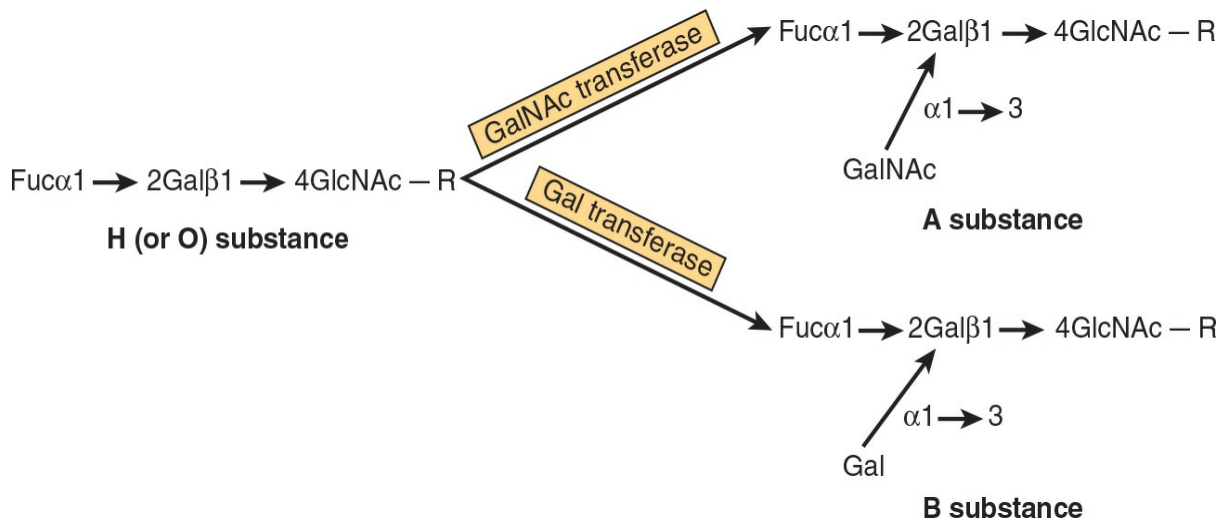
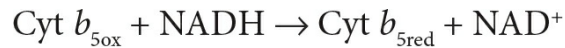

FIGURE 53–7 Diagrammatic representation of the structures of the H, A, and B blood group substances. R represents a long complex oligosaccharide chain, joined either to ceramide where the substances are glycosphingolipids, or to the polypeptide backbone of a protein via a serine or threonine residue where the substances are glycoproteins. Note that the blood group substances are biantennary; that is, they have two arms, formed at a branch point (not indicated) between the GlcNAc—R, and only one arm of the branch is shown. Thus, the H, A, and B substances each contains two of their respective short oligosaccharide chains shown above. The AB substance contains one type A chain and one type B chain.

The A Gene Encodes a GalNAc Transferase, the B Gene a Gal Transferase, & the O Gene an Inactive Product

H substance, the blood group substance found in persons of type O, is the precursor of both the A and B substances (Figure 53–7). It is formed by the action of a **fucosyltransferase**, coded for by the H locus, that catalyzes the addition of an $\alpha 1 \rightarrow 2$ linked fucose onto the terminal Gal residue of its precursor:



A substance contains an additional GalNAc, while **B substance** contains an additional Gal, linked as indicated. These differences reflect the specificity of the glycosyltransferase that catalyzes the addition of the terminal monosaccharide. The A gene encodes a UDP-GalNAc-specific **GalNAc transferase** that adds the terminal GalNAc to H substance. The B gene encodes a UDP-Gal-specific **Gal transferase** that adds the Gal residue to H substance. Individuals of **type AB** possess both enzymes, and thus synthesize two oligosaccharide chains (Figure 53–7), one terminated by GalNAc and the other by Gal.

Anti-A antibodies are directed to the additional GalNAc residue present in the A substance, and anti-B antibodies are directed toward the additional Gal residue found in the B substance. Type O individuals harbor a frameshift mutation in the gene encoding the terminal glycosyltransferase that results in the production of an inactive protein. Thus, H substance is their ABO blood group substance.

An *h* allele arises when a mutation in the portion of H locus that codes for the fucosyltransferase yields an inactive enzyme. While individuals of the heterozygous *Hh* genotype still can synthesize adequate levels of H substance, individuals of the homozygous *hh* genotype cannot. Since H substance is the precursor for A and B substances, all individuals carrying the *hh* genotype will have red blood cells of type O, referred to as the Bombay phenotype (*Oh*), regardless of whether or not they express an A, B, or both A and B terminal glycosyltransferase(s).

PLATELETS

Platelets Contain Mitochondria, But Lack a Nucleus

When megakaryocytes, the progenitors of red blood cells, are exposed to **thrombopoietin** they may fragment and form platelets (Figure 53–1). Like red blood cells, platelets lack a nucleus, but unlike erythrocytes they possess mitochondria, lysozymes, and a tubular network that forms an **open canalicular system**. This honeycomb of channels increases the surface area of the platelets, which are spheroidal at rest, thereby facilitating the secretion of various endocrine and coagulation factors (see Chapter 55). These factors are stored inside the platelets within densely packed secretory vesicles, called **dense granules**, which contain Ca^{2+} , ADP, and serotonin, and **α -granules**, which contain fibrinogen, fibronectin, platelet-derived growth factor, von Willebrand factor, or other

coagulation factors that are released on receipt of an appropriate stimulus. Under normal circumstances, these small (2- μm diameter), enucleated cells circulate at a density of 2 to 4 $\times 10^5$ platelets per milliliter of blood. While platelets derive the majority of their energy from metabolizing glucose, their mitochondria enable them to generate ATP via the β -oxidation of fatty acids. The mechanisms by which platelets become activated to participate in formation of a clot are discussed in [Chapter 55](#).

Platelet Disorders Compromise Hemostasis

Abnormalities in platelet number or function can have serious physiologic consequences. For example, in **acute coronary syndrome**, the formation of enlarged, hyperreactive platelets results in an increased risk of blood clot formation in the circulation, known as **thrombosis**. The presence of larger than normal platelets also correlates with an increased frequency of myocardial infarction.

Immune thrombocytopenic purpura is an autoimmune disorder marked by depressed platelet counts (**thrombocytopenia**) caused by the generation of antibodies against the patient's own platelets. When platelets are decorated with antibodies on their surface, they are subject to clearance by splenic macrophages. In some instances, platelet autoantibodies will bind to differentiating megakaryocytes, depressing platelet production. Thrombocytopenia also can occur when persons who are homozygous for a mutant variant of glycoprotein IIb/IIIa in which the leucine 33 is replaced by proline receive blood from a donor that is homo- or heterozygous for the wild-type form of this major platelet antigen. Exposure to the donor's platelets triggers the production of **alloantibodies** that attack not only the donated platelets, but the patient's endogenous platelets as well. In **neonatal alloimmune thrombocytopenia**, which affects roughly 1 in 200 term pregnancies, antibodies from the mother's circulation cross the placental barrier and attack platelets in the fetus' circulatory system. Thrombocytopenia also can be induced by drugs such as tamoxifen, ibuprofen, vancomycin, and many sulfonamides.

The symptoms of **hemolytic-uremic syndrome**, a disease of infants characterized by progressive kidney failure, include both thrombocytopenia and hemolytic anemia. By contrast, the abnormal bleeding associated with **von Willebrand disease** is caused by a genetic defect that compromises the ability of platelets to adhere to the endothelium, rather than a deficit in platelet number. Other bleeding disorders resulting from defects in platelet adherence include **Bernard-**

Soulier syndrome (genetically inherited deficiency in glycoprotein 1b), and **Glanzmann thrombasthenia** (genetically inherited deficiency in the glycoprotein IIb/IIIa complex).

RECOMBINANT DNA TECHNOLOGY HAS HAD A PROFOUND IMPACT ON HEMATOLOGY

The bases of the **thalassemias** and of many **disorders of coagulation** (see [Chapter 55](#)) have been greatly clarified by investigations utilizing gene cloning and DNA sequencing, while the study of oncogenes and chromosomal translocations has advanced our understanding of the **leukemias**. As discussed above, recombinant DNA technology has made available therapeutically useful quantities of **erythropoietin** and **other growth factors**.

The first pathophysiologic condition to be treated by gene therapy was a deficiency of **adenosine deaminase**. Lymphocytes are particularly sensitive to deficits in this enzyme. In 1990, Dr. William French Anderson introduced a new copy of the gene, carried on a retroviral vector, into a 4-year-old girl suffering from severe combined immunodeficiency (bubble boy disease). Although the patient is still required to take medications, the replacement gene has remained stable into adulthood.

SUMMARY

- Major causes of anemia include blood loss, deficiencies of iron, folate, and vitamin B₁₂, and various factors that cause hemolysis.
- The shape of the red blood cell contributes to the efficiency of gas exchange and to its ability to undergo deformation when passing through capillaries.
- The production of red cells and platelets is regulated by erythropoietin, thrombopoietin, and other cytokines.
- Mature red blood cells, which lack internal organelles, are dependent on glycolysis to generate ATP.
- 2,3-Bisphosphoglycerate mutase catalyzes the isomerization of the glycolytic intermediate 1,3-bisphosphoglycerate to form the 2,3-bisphosphoglycerate, which stabilizes T-state hemoglobin.
- Methemoglobin is unable to transport oxygen.
- Cytochrome *b*₅ reductase reduces the Fe³⁺ of methemoglobin to Fe²⁺, restoring function.

- The red cell contains a battery of cytosolic enzymes—superoxide dismutase, catalase, and glutathione peroxidase—that catalyze the neutralization of reactive oxygen species.
- Deficiencies in the quantity or the activity of glucose-6-phosphate dehydrogenase, which produces NADPH, constitute a major cause of hemolytic anemia.
- Cytoskeletal proteins such as spectrin, ankyrin, and actin interacting with integral membrane proteins underlie the flexible biconcave shape of red blood cells.
- Deficiencies or defects of spectrin can lead to hereditary spherocytosis and hereditary elliptocytosis, both causes of hemolytic anemia.
- Band 4.1 protein facilitates the exchange of bicarbonate and chloride ions across erythrocyte membranes.
- The ABO blood group substances of the red cell membrane are complex glycosphingolipids. The immunodominant sugar of A substance is *N*-acetylgalactosamine, whereas that of B substance is galactose. O substance contains neither of these sugar residues.
- Platelets are small, enucleated fragments of larger precursor cells called megakaryocytes.
- When activated, platelets release effector molecules and fibrinogen stored in secretory granules.
- von Willebrand disease, a bleeding disorder, is caused by a genetic mutation that impairs the ability of platelets to adhere.

REFERENCES

- Alkrimi J, George L: *Medical Diagnosis by Analysis of Blood Cell Images*. Lambert Academic Publishing, 2014.
- Dzierzak E, Philipsen S: Erythropoiesis: development and differentiation. *Cold Spring Harb Perspect Med* 2013;3:a011601.
- Israels SJ (editor): *Mechanisms in Hematology*, 4th ed. Core Health Sciences Inc, 2011.
- Martin JF, Kristensen SD, Mathur A, et al: The causal role of megakaryocyte platelet hyperactivity in acute coronary syndromes. *Nat Rev Cardiol* 2012;9:658.
- Naria A, Ebert BL: Ribosomopathies: human disorders of ribosome dysfunction. *Blood* 2010;115:3196.
- Smyth SS, Whiteheart S, Italiano JE Jr, Collier BS: Platelet morphology, biochemistry, and function. In: *Williams Hematology*, 8th ed.

Kaushansky K, Lichtman MA, Beutler E, et al (editors). McGraw-Hill, 2010;1735.

Whichard ZL, Sarkar CA, Kimmel M, Corey SJ: Hematopoiesis and its disorders: a systems biology approach. Blood 2010;115:2339.

White Blood Cells

Peter J. Kennelly, PhD & Robert K. Murray, MD, PhD

OBJECTIVES

After studying this chapter, you should be able to:

- Describe how white blood cells work in concert to combat infection and to trigger an inflammatory response.
- List the basic steps in elimination of infectious microorganisms by phagocytosis.
- Describe the role of chemotaxis in leukocyte function.
- List the key components found within the granules of phagocytes and basophils and describe their primary functions.
- List the reactive oxygen species produced during the respiratory burst.
- Explain the basis for the physiologic effects caused by defects in the NADPH oxidase system.
- Explain the molecular basis of type 1 leukocyte adhesion deficiency.
- Describe how neutrophils and eosinophils entrap parasites using neutrophil extracellular traps (NETs).
- Describe the role of the helper T cells in the production of new antibodies.

- Define the term cytokine and describe the key characteristics of interleukins, interferons, prostaglandins, and leukotrienes.

BIOMEDICAL IMPORTANCE

White blood cells, or **leukocytes**, serve as key sentries and potent defenders against invading pathogens. **Neutrophils**, the most abundant type of white blood cell, ingest and destroy invading bacteria and fungi by a process known as **phagocytosis**, while **eosinophils** phagocytize larger parasites. Circulating **monocytes** migrate from the bloodstream to diseased tissues, where they differentiate into phagocytic **macrophages**.

Granulocytes such as **basophils** and **mast cells** release stored effectors that attract additional leukocytes to the site of infection and trigger an inflammatory response. **B lymphocytes** generate and release protective antibodies with the assistance of **T lymphocytes**. Other lymphocytes, such as **cytotoxic T cells** and **natural killer cells**, target virally infected and malignantly transformed host cells.

Malignant neoplasms of blood-forming tissues, called **leukemias**, can lead to the uncontrolled production of one or more of the major classes of white blood cells. The hyperactivation of granulocytes during an allergic response can, in extreme cases, lead to **anaphylaxis** and death.

Leukopenia, a depression in the production of white blood cells, can result from physical injury or infection of the bone marrow, chemotherapy, ionizing radiation, infection by the **Epstein-Barr virus** (mononucleosis), an autoimmune response (**lupus**), or the displacement of bone marrow cells by fibrous tissues (**myelofibrosis**). The resulting deficit in the levels of circulating leukocytes can leave the affected individual vulnerable to infection (**immunocompromised**).

DEFENSE AGAINST INFECTION REQUIRES MULTIPLE CELL TYPES

The white blood cells, or **leukocytes**, are key participants in the **acute inflammatory response**, a multicomponent process that defends the body against infectious organisms and ameliorates the impact of tissue infection or morbidity. The principal steps in an inflammatory response include (1) an increase in vascular permeability, (2) entry of activated leukocytes into the tissues, (3) activation of platelets, and (4) spontaneous subsidence (resolution) if the invading microorganisms have been dealt with

successfully. **Basophils** secrete hematologic effectors such as histamines (**Figure 54–1**) that facilitate the accumulation of fluid within infected or damaged tissues as well as chemokines that attract additional **neutrophils**. The activated neutrophils encapsulate invading bacteria within membrane vesicles (**phagocytosis**) and destroy them using a combination of hydrolytic enzymes, reactive oxygen species (ROS), and antimicrobial peptides. Circulating **monocytes** are the precursors of phagocytic **macrophages**, which phagocytize infected and damaged host cells. **Lymphocytes** produce protective antibodies that target foreign invaders and tag them for elimination.

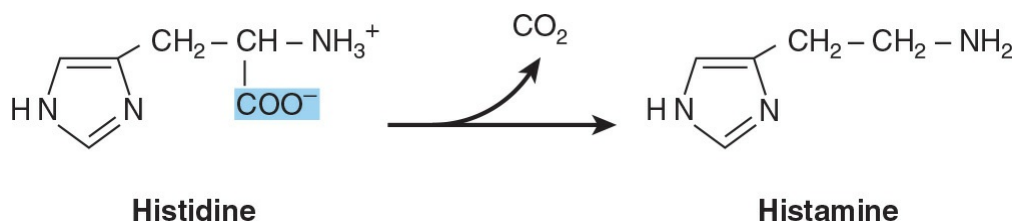

FIGURE 54–1 Structures of histidine and its decarboxylation product, histamine.

Leukocytes, unlike red blood cells and platelets, possess a full complement of internal organelles. However, the nuclei of many leukocytes exhibit marked deviations from the compact, spherical organelle typical of most eukaryotic cells. In monocytes, for example, the nuclei are unusually large and noticeably irregular in shape while in neutrophils, eosinophils, and other **polymorphonuclear leukocytes** they segment into multiple lobes.

MULTIPLE EFFECTORS REGULATE THE PRODUCTION OF WHITE BLOOD CELLS

Most white blood cells turn over rapidly and thus must be continually replaced. The lifetime of a circulating myeloid leukocyte, for example, ranges from a few hours to a few days, while most lymphocytes persist for only a few weeks in the blood. A notable exception to this pattern is **memory lymphocytes**, which may live for several years. The production of monocytes and granulocytes proceeds via the formation of a **common myeloid progenitor**, while differentiation of hematopoietic stem cells into lymphocytes proceeds via the formation of a **common lymphoid progenitor** (see **Figure 53–1**). The proliferation of hematopoietic stem cells and the determination of their ultimate fate is controlled by the

concerted influences of multiple effector molecules. Stem cell growth factor, granulocyte-macrophage colony-stimulating factor, and interleukins 5 and 6, for example, stimulate the production of granulocytes (neutrophils, eosinophils, basophils) and monocytes, a process that proceeds via the formation of **myeloid progenitor cells**. Tumor necrosis factor α , transforming growth factor β_1 , and interleukins 2 and 7 promote the formation of **lymphoid progenitor cells** and their eventual maturation into B and T lymphocytes.

LEUKOCYTES ARE MOTILE

Leukocytes Migrate in Response to Chemical Signals

Leukocytes can be found throughout the body, migrating from the blood to sites of injury or infection in response to chemical signals, a process referred to as **chemotaxis**. Migration out of the circulation takes place via **diapedesis**, an amoeboid mechanism involving the cytoskeleton-mediated contortion of the cell (**Figure 54–2**). A thin pseudopod is extended between the cells of the capillary endothelium. Once anchored on the other side, cytoskeletal proteins squeeze the contents of the cell through the projection, which fills the distal end of the pseudopod to form a new, translocated cell body, leaving behind the deflated remains. Once within the tissues, locomotion proceeds via a similar, stepwise amoeboid mechanism.

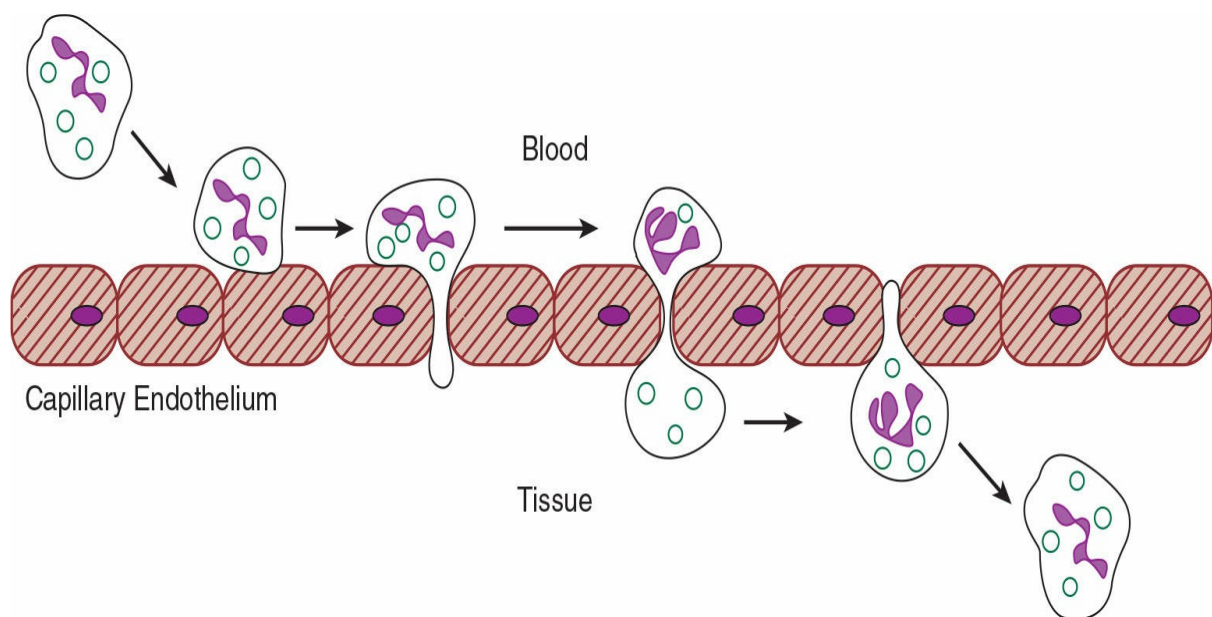

FIGURE 54–2 Diapedesis. Shown, from left to right, are the major steps in diapedesis, the process by which neutrophils and other leukocytes

traverse the capillary wall, whose cells are shown in red, in response to chemotactic signals. Cell nuclei are shown in purple and granules in green.

Chemotaxis Is Mediated By G-Protein–Coupled Receptors

Leukocytes are attracted to tissues by **chemotactic factors** such as chemokines, complement fragment C5a, small peptides derived from bacteria (eg, *N*-formyl-methionyl-leucyl-phenylalanine), and several leukotrienes. These factors bind to one of several cell surface receptors that share similar transmembrane domains comprised of seven membrane-spanning α -helices. Because these receptors all are closely coupled with one or more heterotrimeric guanosine nucleotide-binding proteins (**G-proteins**), they are often referred to as G-protein–coupled receptors. Upon ligand binding, a signal transduction cascade is initiated in which G-proteins activate **phospholipase C**, which hydrolyses phosphatidylinositol 4,5-bisphosphate to produce **diacylglycerols** and the water-soluble second messenger **inositol 1,4,5-triphosphate** (IP₃). The appearance of IP₃ triggers the release of Ca²⁺, leading to a transient increase in the level of cytoplasmic Ca²⁺. In neutrophils, the appearance of cytoplasmic Ca²⁺ activates the components of the actin-myosin cytoskeleton responsible for effecting cell migration and granule secretion. Diacylglycerol, together with Ca²⁺, stimulates protein kinase C and induces its translocation from the cytosol to the plasma membrane, where it catalyzes the **phosphorylation** of various proteins, including some involved in triggering the respiratory burst (see below).

Chemokines Are Stabilized by Disulfide Bonds

Chemokines are small, generally 6 to 10 kDa, proteins secreted by activated white blood cells in order to attract additional neutrophils to a site of infection or injury. Chemokines can be divided into four subclasses based on the number and spacing of the cysteine residues that form the disulfide bonds that stabilize the protein's conformation (**Figure 54–3**). Type C chemokines are characterized by an intrachain disulfide bond formed by a pair of conserved cysteine residues. In addition to the conserved disulfide bond present in type C, the other three recognized chemokine groups possess a second disulfide bond. In type CC chemokines, one of the additional cysteine residues lies adjacent to the

first of the first pair of universally conserved residues. In types CXC and CX₃C, these cysteines are separated by one and three intervening amino acid residues, respectively. CX₃C chemokines, the largest of the four types of cytokines, have a longer C-terminus that includes sites of covalent modification by glycosylation.

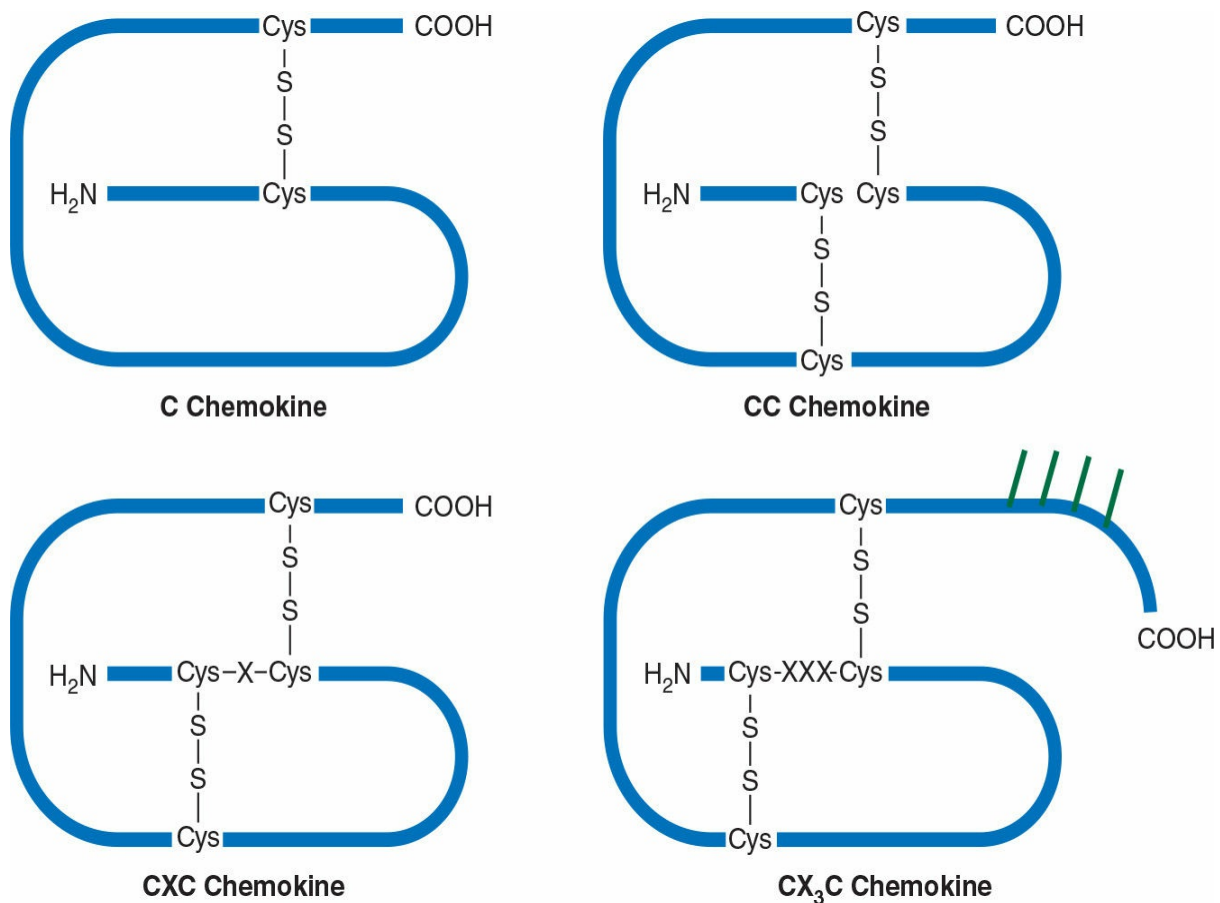

FIGURE 54–3 Chemokines. This figure depicts the key structural features of type C, CC, CXC, and CX₃C chemokines. The polypeptide chains are depicted in blue with their amino and carboxy termini marked by H₂N and COOH, respectively. Key cysteine residues are denoted as Cys, conserved disulfide bonds at S-S, and spacer amino acids for types CXC and CX₃C using X. Bound carbohydrate is depicted in green.

Integrins Facilitate Diapedesis

The adhesion of leukocytes to vascular endothelial cells is mediated by transmembrane glycoproteins of the **integrin** and **selectin** families (see the discussion of **selectins** in [Chapter 46](#)). **Integrins** consist of noncovalently associated α and a β subunits, each of which contains an extracellular,

transmembrane, and intracellular segment. The extracellular segments bind to various extracellular matrix proteins that possess Arg-Gly-Asp sequences, while the intracellular domains bind to cytoskeletal components such as actin and vinculin. Their ability to link the exterior of a cell with its interior enables integrins to link leukocyte responses (eg, movement and phagocytosis) to changes in the surrounding environment. Some integrins of specific interest with regard to neutrophils are listed in **Table 54–1**.

TABLE 54–1 Principal Integrins of White Blood Cells and of Platelets^a

Integrin	Cell	Subunit	Ligand	Function
VLA-1 (CD49a)	WBCs, others	$\alpha 1\beta 1$	Collagen, laminin	Cell-ECM adhesion
VLA-5 (CD49e)	WBCs, others	$\alpha 5\beta 1$	Fibronectin	Cell-ECM adhesion
VLA-6 (CD49f)	WBCs, others	$\alpha 6\beta 1$	Laminin	Cell-ECM adhesion
LFA-1 (CD11a)	WBCs	$\alpha L\beta 2$	ICAM-1	Adhesion of WBCs
Glycoprotein IIb/IIIa	Platelets	$\alpha IIb\beta 3$	ICAM-2	
Fibrinogen, fibronectin, von Willebrand factor	Platelet adhesion and aggregation			

In **type 1 leukocyte adhesion deficiency**, the lack of the $\beta 2$ subunit (also designated CD18) of LFA-1 and of two related integrins found in neutrophils and macrophages, Mac-1 (CD11b/CD18) and p150,95 (CD11c/CD18), impairs the ability of the affected leukocytes to adhere to vascular endothelial cells, impeding diapedesis. Since fewer white blood cells enter their infected tissues, affected individuals tend to suffer from recurrent bacterial and fungal infections.

INVADING MICROBES AND INFECTED CELLS ARE DISPOSED BY PHAGOCYTOSIS

Phagocytes Ingest Target Cells

White blood cells typically destroy invading microorganisms via **phagocytosis (Figure 54–4)**. Phagocytic leukocytes recognize and bind target cells using receptors that recognize bacterial lipopolysaccharides or peptidoglycans. In most cases, however, infective pathogens are recognized indirectly, by the presence of antibodies or complement factors

that have previously adhered to their surface (see [Chapter 52](#)). The process of tagging an invader with protective proteins to facilitate recognition by phagocytic leukocytes is called **opsonization**.

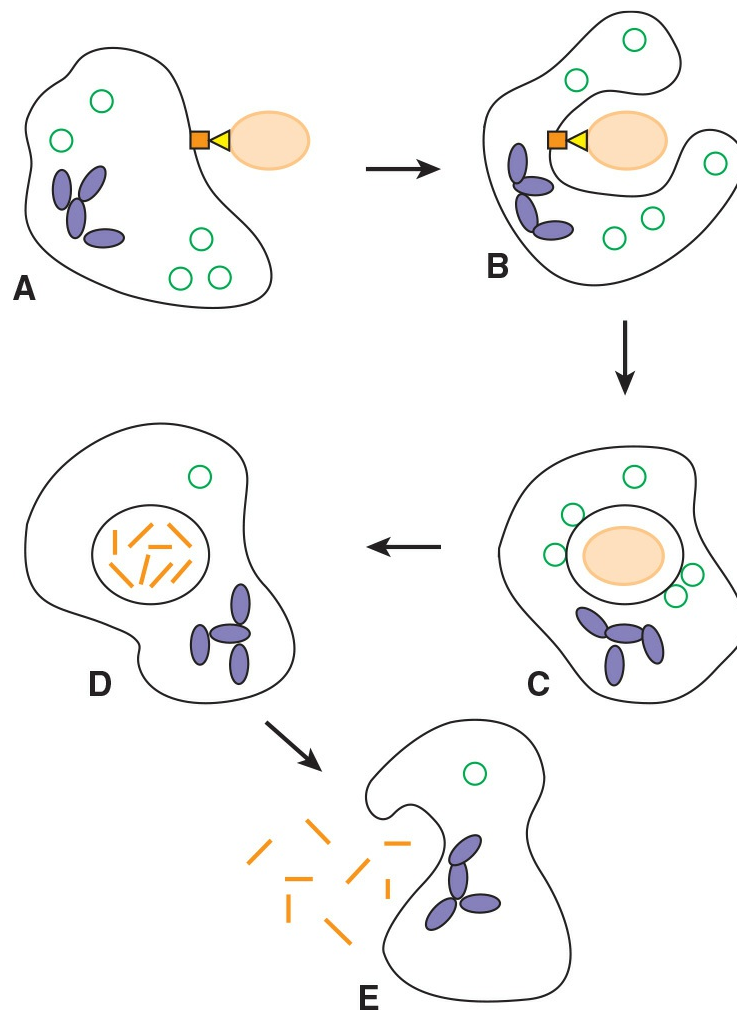

FIGURE 54–4 Phagocytosis. This figure depicts the destruction of an opsonized microorganism, shaded in ORANGE, by a neutrophil via phagocytosis. The multilobed nucleus of the neutrophil is shown in purple, secretory granules in green. The presence of an antibody or complement tag is indicated by a yellow triangle, with the corresponding cell surface receptor as a bright orange square. Cellular debris from the microorganism is represented as orange line segments. **(A)** The neutrophil binds an antigen molecule on the opsonized microbe via a receptor. **(B)** The neutrophil envelops the microbe. **(C)** Secretory granules fuse with the newly internalized phagosome, delivering their contents. **(D)** Granule-derived enzymes and cytotoxins destroy the microorganism. **(E)** The phagosome then fuses with the cell membrane, expelling any remaining debris.

Receptor binding triggers dramatic alterations in the shape of the phagocyte, which proceeds to envelop the target cell until it is encased within an internalized membrane vesicle called a **phagosome** (phagolysosome). The encapsulated invader is then destroyed using a combination of hydrolytic enzymes (eg, lysozyme, proteases), antimicrobial peptides (defensins), and reactive oxygen species. These enzymes and toxins are stored in cytoplasmic vesicles known as **granules**, which then fuse with the phagosome (**Table 54–2**). Since these granules can be observed under a microscope, the cells that harbor them are referred to as **granulocytes**. Eventually, after digestion of the microbial invader and absorption of their component sugars, amino acids, etc, the phagosome migrates to the plasma membrane of the white blood cell, where it fuses and expels the remaining debris.

TABLE 54–2 Enzymes and Proteins of the Granules of Phagocytic Leukocytes

Enzyme or Protein	Reaction Catalyzed or Function	Comment
Myeloperoxidase (MPO)	$H_2O_2 + X^- (\text{halide}) + H^+ \rightarrow HOX + H_2O$ where $X^- = Cl^-$, HOX = hypochlorous acid	Responsible for the green color of pus Genetic deficiency can cause recurrent infections
NADPH oxidase	$2O_2 + NADPH \rightarrow 2O_2^- + NADP + H^+$	Key component of the respiratory burst Deficient in chronic granulomatous disease
Lysozyme	Hydrolyzes link between N-acetylmuramic acid and N-acetyl-D-glucosamine found in certain bacterial cell walls	Abundant in macrophages. Hydrolyzes bacterial peptidoglycans
Defensins	Basic antibiotic peptides of 20-33 amino acids	Apparently kill bacteria by causing membrane damage
Lactoferrin	Iron-binding protein	May inhibit growth of certain bacteria by binding iron and may be involved in regulation of proliferation of myeloid cells
Elastase Collagenase Gelatinase Cathepsin G	Proteases	Abundant in phagocytes; Breakdown protein components of infectious organisms; Generate fragments for antigen presentation

The components of this debris, which include fragments of proteins, oligosaccharides, lipopolysaccharides, peptidoglycans, and polynucleotides, provide an important source of antigens for stimulating the production of new antibodies. **Helper T cells** and other leukocytes absorb these materials via endocytosis (see **Figure 40–21**), then route them to the cell surface in association with a membrane protein called the **major**

histocompatibility complex (MHC). The MHC serves as a scaffold for presenting potential antigens to surrounding lymphocytes in a form likely to stimulate the production of new antibodies.

The three principal classes of phagocytic leukocytes are **neutrophils**, **eosinophils**, and **macrophages**. Neutrophils, which comprise roughly 60% of the white blood cells present in the circulation, phagocytize bacteria and small eukaryotic microorganisms such as fungi. The less numerous **eosinophils**, which make up 2 to 3% of the leukocytes in the blood, ingest larger eukaryotic microorganisms such as **paramecia**. Macrophages are derived from monocytes, which comprise about 5% of the leukocytes in the blood. Monocytes migrate from the bloodstream into tissues throughout the body where, upon receipt of a stimulus, they differentiate to form **macrophages**. While macrophages can ingest invading microbes, the signature function of these large phagocytes is to destroy human host cells that have been compromised by infection, malignant transformation, or programmed cell death, also known as **apoptosis**. These functionally compromised cells are recognized by the appearance of aberrant proteins and oligosaccharides on their surface. Precocious activation of macrophages is associated with the etiology of many degenerative diseases such as osteoporosis, atherosclerosis, arthritis, and cystic fibrosis. They also can facilitate the metastasis of cancer cells.

Phagocytic Leukocytes Generate Reactive Oxygen Species During the Respiratory Burst

Phagocytes employ **ROS** such as $O_2^{\cdot -}$, H_2O_2 , OH^{\cdot} , and HOCl (hypochlorous acid) as a major component of the chemical and enzymatic arsenal used to destroy ingested cells. Production of the various ROS takes place shortly (15-60 seconds) after internalization of an encapsulated cell, using O_2 and electrons derived from NADPH. The accompanying surge in oxygen consumption has been termed the **respiratory burst**. Producing the large quantities of NADPH required via the pentose phosphate pathway (see [Chapter 20](#)) is facilitated by the phagocyte's heavy reliance on aerobic glycolysis to generate ATP, a consequence of the low number of mitochondria contained within them.

The first step in the formation of microbicidal ROS during the respiratory burst is the synthesis of superoxide, which is catalyzed by the **NADPH oxidase system**. Catalysis proceeds via a two-step mechanism, the reduction of molecular oxygen to form superoxide ([Table 54–2](#)):

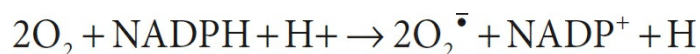

followed by the spontaneous dismutation of **hydrogen peroxide** from two molecules of superoxide:



The NADPH oxidase system is comprised of **cytochrome b_{558}** , a plasma membrane-associated heterodimer, and two cytoplasmic polypeptides of 47 and 67 kDa. Upon activation, the cytoplasmic peptides are recruited to the plasma membrane where they associate with cytochrome b_{558} to form the active complex. Flux through the pentose phosphate cycle, the cell's primary source of NADPH, also increases markedly during phagocytosis. The cell is protected from any superoxide that may escape from the phagosomes by **superoxide dismutase**, which catalyzes the transformation of two superoxide radical anions into H_2O_2 and O_2 . The hydrogen peroxide can be used as a substrate for myeloperoxidase (see below) or disposed of by the action of glutathione peroxidase or catalase.

Myeloperoxidase Catalyzes the Production of Chlorinated Oxidants

The formation of hypohalous acids during the respiratory burst is catalyzed by the enzyme **myeloperoxidase**.

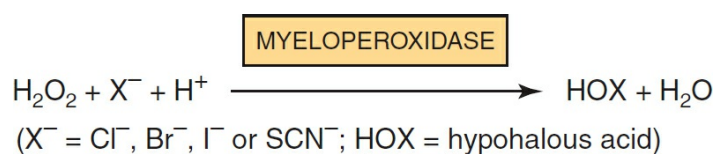

Present in large amounts in neutrophil granules, this enzyme uses H_2O_2 and to oxidize Cl^- and other halides to produce **HOCl** and other hypohalous acids. HOCl, the active ingredient of household liquid bleach, is a powerful oxidant that is highly microbicidal. When used to sterilize wounds, it reacts with primary or secondary amines present to produce various nitrogen-chlorine derivatives. These **chloramines** are less powerful oxidants than HOCl, allowing them to act as microbicidal agents without causing damage to the surrounding tissue.

Mutations Affecting the NADPH Oxidase System Cause Chronic Granulomatous Disease

Functionally deleterious mutations in the genes encoding any of the four polypeptides of the NADPH oxidase system can cause **chronic granulomatous disease**. The resulting impairment of the production of ROS undermines the ability of phagocytic leukocytes to kill ingested pathogens. Although relatively uncommon, persons suffering from this condition experience recurrent infections. They also form granulomas (chronic inflammatory lesions) in the skin, lungs, and lymph nodes as a means to wall off invading pathogens. In some cases, relief can be provided by the administration of gamma interferon, which may increase transcription of the 91-kDa component of cytochrome *b*₅₅₈.

NEUTROPHILS AND EOSINOPHILS EMPLOY NETS TO ENTRAP PARASITES

In addition to ingesting small microorganisms such as bacteria by phagocytosis, neutrophils and eosinophils can assist in the elimination of larger invaders by trapping them within webs called **neutrophil extracellular traps** or NETs (**Figure 54–5**). The strands for these NETs are composed of polynucleotide strands generated by the dispersal, or **decondensation**, of a neutrophil's chromosomal DNA. This process involves rupture of the nuclear membrane and the disruption of the favorable charge–charge interactions that normally stabilize chromatin. Dissolution of histone-polynucleotide complexes is promoted by the enzyme **peptidylarginine deiminase**, which catalyzes the deimination of the strongly basic side chains of arginine residues to form neutral citrulline residues (**Figure 54–6**). Some chromatin proteins do remain associated with the DNA, forming cross-links between the polynucleotide strands. Granule membranes also rupture at this time, releasing their contents into the cytoplasm where they can bind to the decondensing polynucleotide strands, decorating the DNA with granule-derived proteases, antimicrobial peptides, and other factors. Eventually, the neutrophils lyse, unleashing their NETs upon invading parasites in order to immobilize them and hinder their spread.

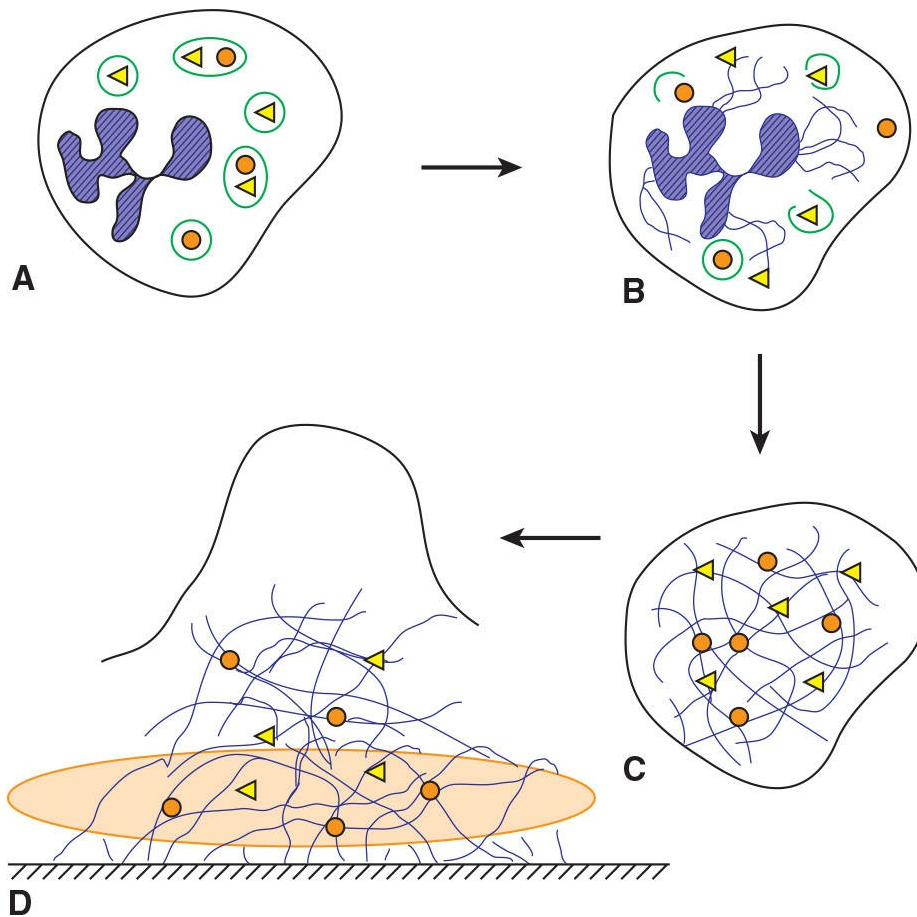

FIGURE 54–5 Trapping parasites using NETs. The figure depicts the basic stages in the formation and deployment of a DNA-based web by a neutrophil or eosinophil to trap a parasitic microorganism. **(A)** Resting neutrophil. The multilobed nucleus is shown in hatched purple, intracellular granules in green, and granule enzymes and cytotoxins as orange circles and yellow triangles. **(B)** Upon stimulation, the membranes encasing the nucleus and granules rupture, releasing enzymes, cytotoxins, and strands of DNA (purple) from decondensing chromosomes. **(C)** The DNA strands form a mesh that fills the interior of the cell to which some granule-derived proteins adhere. **(D)** The neutrophil lyses, releasing its DNA-protein web, which entraps the parasite (orange) against surface of the epithelium (hatched).

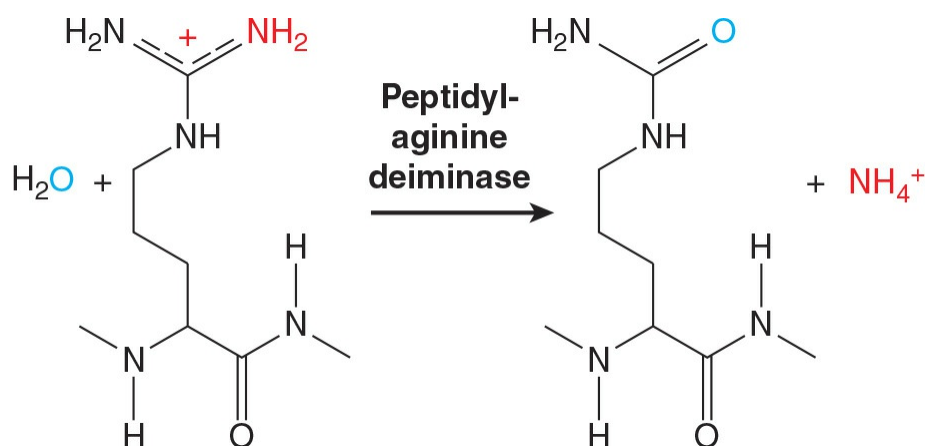

FIGURE 54–6 Citrullination. The enzyme peptidyl arginine deiminase displaces one of the imino groups (red) on the side chain of arginine by an oxygen atom (blue) derived from water. The net result is to replace a positive charge provided by the protonated arginine side chain by an amide, which is neutral.

PHAGOCYTE-DERIVED PROTEASES CAN DAMAGE HEALTHY CELLS

Macrophages and other phagocytes produce numerous proteases ([Table 54–2](#)), several of which can hydrolyze elastin, various types of collagen, and other proteins present in the extracellular matrix. Although small amounts of elastase and other proteinases leak out into normal tissues, their activities are normally kept in check by a number of **antiproteinases** present in plasma and the extracellular fluid (see [Chapter 52](#)). One of these, **α 2-macroglobulin**, forms a noncovalent complex with certain proteinases, thereby inhibiting their activity. A genetic defect that permits elastase to act upon pulmonary tissue unchecked by inhibitors of proteolysis such as **α ₁-antiproteinase inhibitor** (α ₁-antitrypsin) contributes significantly to the causation of emphysema.

Elevated levels of chlorinated oxidants formed during inflammation can tilt the balance between proteinases and antiproteinases in favor of the former. For instance, some of the proteinases listed in [Table 54–2](#) are **activated** by HOCl, while several of the countervailing antiproteinases are inactivated by this same hypohalous acid. In addition, these inhibitory proteins can themselves be degraded by proteases. For example, tissue inhibitor of metalloproteinases and α ₁-antichymotrypsin can be hydrolyzed by elastase while α ₁-antiproteinase inhibitor can be hydrolyzed by collagenase and gelatinase. While an appropriate balance between

proteinases and antiproteinases is generally maintained, in certain instances, such as when inadequate drainage leads to the accumulation of large numbers of neutrophils, considerable **tissue damage** can result.

LEUKOCYTES COMMUNICATE USING SECRETED EFFECTORS

The development of the immune and inflammatory responses by injured or infected tissues requires the coordinated action of leukocytes and other cells. Much of this coordination is accomplished by secreting a diverse set of small (< 25 kDa) proteins, termed **cytokines**, that includes interleukins, interferons, and chemokines.

The more than three dozen known **interleukins** derive their name from the cells in which they are synthesized and from which they are secreted. They are generally designated by the class abbreviation **IL** followed by an identifying number, eg, IL1, IL3, IL22. The **interferons (IFN)**, on the other hand, derive their name from their ability to inhibit, or interfere, with the replication of infecting viruses. Approximately 10 distinct families of interferons have been identified in animals to date. **Chemokines** attract and activate migrating leukocytes to a site of injury or infection. Most cytokines are glycosylated. In general, they stimulate both the leukocytes from which they are secreted (**autocrine signaling**) as well as other types of leukocytes (**paracrine signaling**). Historically, cytokines have been distinguished from hormones by their close association with immunity and inflammation.

Leukocytes also secrete lipid mediators, called **eicosanoids**, produced by the oxidation of arachidonic acid (see [Chapter 15](#)). These lipid mediators fall into two broad classes, **leukotrienes** and **prostaglandins**. Leukotrienes are characterized by the presence of a set of three conjugated carbon–carbon double bonds. Several incorporate the amino acid cysteine into their structure. Prostaglandins, which were first isolated from the prostate gland, contain 20 carbon atoms and are distinguished by their common five-membered ring.

Histamine (Figure 54–1), which is synthesized by decarboxylating the amino acid histidine, is secreted in large amounts by activated **basophils** and **mast cells**. Histamine works with other hematologic factors, such as heparin and eicosanoids, to maintain blood flow to the site of injury or infection and stimulate the accumulation of fluid (edema). The resulting inflammation enhances an immune response as the accumulated fluid facilitates leukocyte migration.

LYMPHOCYTES PRODUCE PROTECTIVE ANTIBODIES

Lymphocytes make up approximately 30% of the leukocytes present in the blood. By virtue of their capacity to produce novel protective antibodies against newly encountered antigens (see [Chapter 53](#)), lymphocytes form the cornerstone of the body's **adaptive immune system**. The classification of lymphocytes into B and T types originally was based on the identity of the tissues in which each form completed their maturation. In avian species, the B lymphocytes (B cells) are processed in the **bursa of Fabricius**. The B cells in humans, which lack this organ, mature in the **bone marrow**. Maturation of **T lymphocytes (T cells)** takes place in the **thymus**. B lymphocytes secrete the soluble antibodies present in bodily humors, for example, plasma and interstitial fluids, and are therefore said to confer **humoral immunity**.

Lymphocytes that have yet to be stimulated to produce immunoglobulins are said to be **naïve**. Synthesis of a new antibody can be triggered by several mechanisms. Lymphocytes can bind directly to foreign invaders via one of the many receptors present on their surface configured to bind bacterial glycoproteins, lipopolysaccharide, or peptidoglycan. Alternatively, the lymphocyte can be activated by encountering an antigen that has been presented on the surface of another white blood cell in association with the major histocompatibility complex. Macrophages, neutrophils, and phagocytic lymphocytes called **plasma cells** all display or present fragments of macromolecules they have destroyed by phagocytosis. In addition, **helper T cells** present antigens on their surface, including debris ejected by phagocytes, that has been ingested by endocytosis. **Helper T cells** also serve as “cellular switchboards,” coordinating the immune response by receiving, processing, and sending signals from and to other components of the immune system.

Cytotoxic T cells recognize proteins that appear on the surface of host cells as a consequence of viral infection or oncogenic transformation. Once bound, they induce the lysis of the target cell using perforins, proteins that form channels in the plasma membrane, and proteases called granzymes, which mimic the action of the cathepsin proteases that normally trigger programmed cell death (**apoptosis**). **Natural killer cells** resemble cytotoxic T cells, but contain granules holding additional toxic chemicals to aid in their attack.

SUMMARY

- The elimination of infectious microorganisms involves the cumulative actions of multiple types of leukocytes, including lymphocytes, phagocytes, and basophils.
- White blood cells communicate using secreted effector molecules such as chemokines, prostaglandins, leukotrienes, interleukins, and interferons.
- Leukocytes migrate from the blood to the tissues in response to specific chemical attractants, a process termed chemotaxis.
- The amoeboid migration of leukocytes from blood to the tissues relies on cytoskeletonally mediated cell flexibility and deformation.
- Basophils secrete histamine and heparin, which facilitate the migration of leukocytes by inducing fluid accumulation at a site of infection or injury.
- Integrins mediate the adhesion of white blood cells to the vascular endothelium, the first step in migration toward infected tissues.
- Phagocytes internalize invading microorganisms inside membrane vesicles called phagosomes.
- Destruction of phagocytized microorganisms is accomplished using a combination of reactive oxygen species (the respiratory burst), hydrolytic enzymes, and cytotoxic peptides.
- Mutations in proteins of the NADPH oxidase system cause chronic granulomatous disease.
- Neutrophils and eosinophils defend against large parasites by immobilizing them within webs comprised of strands of chromosomal DNA.
- Decondensation of chromosomal DNA is facilitated by citrullination of arginine side chains on histones.
- Lymphocytes produce protective immunoglobulins (antibodies) that confer humoral immunity.
- Phagocytes and helper T cells stimulate the production of new antibodies by presenting fragments of pathogen-derived macromolecules on their surface.
- Cytotoxic T cells and natural killer cells recognize and destroy host cells that display cell surface proteins and glycolipids characteristic of viral infection or malignant transformation.

REFERENCES

- Adkis M, Burgler S, Cramer R, et al: Interleukins, from 1 to 37, and interferon- γ : receptors, functions, and roles in diseases. *J Allergy Clin Immunol* 2011;127:701.
- Gulati G, Caro J: *Blood Cells: Morphology and Clinical Relevance*, 2nd ed. American Society of Clinical Oncology, 2014.
- Henderson GI: *Leukocytes: Biology, Classification and Role in Disease*. Novoc Sci Publ, 2012.
- Hillman R, Ault K, Rinder H: *Hematology in Clinical Practice*. 5th ed. McGraw-Hill, 2010.
- Mayadas TN, Cullere X, Lowell CA: The multifaceted functions of neutrophils. *Annu Rev Pathol* 2014;9:181.
- Nordenfelt P, Tapper H: Phagosome dynamics during phagocytosis by neutrophils. *J Leukocyte Biol* 2011;90:271.
- Wynn TA, Chawla A, Pollard JW: Macrophage development in development, homeostasis and disease. *Nature* 2013;496:445.

Exam Questions

Section X – Special Topics (B)

1. Briefly describe the mode of action of nitroglycerin, a common agent for treating angina.
2. Patients being treated for heart failure oftentimes exhibit decreased expression and defective regulation of SERCA2a, the principal Ca^{2+} -ATPase of the sarcoplasmic reticulum. Explain how defects in this protein might contribute to deterioration in cardiac function.
3. Select the one of the following that is NOT CORRECT:
 - A. The troponin system regulates contraction of smooth muscle.
 - B. Muscle contraction takes place via a sliding filament mechanism.
 - C. Myosin light-chain kinase phosphorylates the regulatory light chains in the myosin head domain.

- D. F-actin is formed via the polymerization of G-actin.
- E. Ca^{2+} both activates muscle contraction and stimulates its own removal by activating the Ca^{2+} ATPase.
4. A patient anesthetized using a halothane compound exhibits a marked rise in body temperature, a behavior indicative of malignant hyperthermia (MH). Select the one of the following statements that is NOT CORRECT:
- A. MH can arise from mutations that alter the amino acid sequence of the Na^+ - K^+ -ATPase.
 - B. MH can arise from mutations that alter the amino acid sequence of the ryanodine-sensitive Ca^{2+} release channel.
 - C. The muscle rigidity that occurs during MH is triggered by the presence of high concentrations of Ca^{2+} in the cytoplasm.
 - D. MH can arise from mutations that alter the amino acid sequence of the voltage-gated, slow K-type Ca^{2+} channel.
 - E. MH can be treated by intravenous administration of dantrolene, which inhibits release of Ca^{2+} from the sarcoplasmic reticulum into the cytosol.
5. Select the one of the following statements that is NOT CORRECT:
- A. Fast-twitch fibers rely heavily on creatine phosphate to regenerate ATP.
 - B. Slow-twitch fibers appear red because they contain hemoglobin.
 - C. Fast-twitch fibers contain relatively few mitochondria.
 - D. Marathoners try to increase the quantity of glycogen in their muscles by eating carbohydrate-rich meals before an event (carbo loading).
 - E. Skeletal muscle serves as the major reserve of protein in the body.
6. Select the one of the following that is NOT a feature of the contractile cycle in striated muscle:
- A. Binding of Ca^{2+} to troponin C uncovers the myosin-binding sites on actin.
 - B. The power stroke is initiated by the release of P_i from the actin-myosin-ADP- P_i complex.

- C. Release of ADP from the actin-myosin-ADP complex is accompanied by a large change in the conformation of myosin's head domain (relative to its tail domain).
 - D. The binding of ATP by myosin increases its affinity for actin.
 - E. Rigor mortis results for the inability of actin to release from the actin-myosin complex when cells are deficient in ATP.
7. Select the one of the following that does NOT serve as a major energy reserve for replenishing ATP in muscle tissue:
- A. Glycogen
 - B. Creatine phosphate
 - C. ADP (in conjunction with adenylyl kinase)
 - D. Fatty acids
 - E. Epinephrine
8. Select the one of the following statements that is NOT CORRECT:
- A. The drugs colchicine and vinblastine inhibit microtubule assembly.
 - B. Mutations affecting keratin can lead to blistering.
 - C. Mutations in the gene encoding lamin A and lamin C cause progeria (accelerated aging).
 - D. α - and β -tubulin are the major components of stress fibers.
 - E. Molecular motors such as dynein, kinesin, and dynamin power ciliary movement, vesicle transport, and endocytosis.
9. Select the one of the following statements that is NOT CORRECT:
- A. The major function of the Ca^{2+} channels in cardiomyocytes is to admit extracellular calcium ions into the cell in order to trigger Ca^{2+} -induced Ca^{2+} release from the SR.
 - B. Digitalis increases the forcefulness of cardiac contractions by raising the level of intracellular Na^+ .
 - C. Certain types of muscular dystrophies are caused by mutations in enzymes called glycosyltransferases.
 - D. Dantrolene relaxes skeletal muscle by inhibiting the release of Ca^{2+} from the SR.
 - E. In the SR, Ca^{2+} is bound to a specific Ca^{2+} -binding protein called calmodulin.

10. Describe the role of haptoglobin in the protection of the kidneys from the potentially damaging effects of extracorporeal hemoglobin.
11. Briefly describe how activation of cytidine deaminase helps generate immunoglobulins with unique antigen-binding sites.
12. Select the one of the following statements that is NOT CORRECT:
 - A. Interleukin 1 stimulates the production of acute-phase proteins.
 - B. Iron must be reduced to the ferrous (Fe^{2+}) state in order to be recovered via the transferrin cycle.
 - C. Many complement proteins are zymogens.
 - D. The type 2 transferrin receptor (TfR2) functions primarily as an iron sensor.
 - E. Mannose-binding lectin binds carbohydrate groups present on the surface of invading bacteria.
13. Select the one of the following statements that is NOT CORRECT:
 - A. Albumin is synthesized as a proprotein.
 - B. Albumin is stabilized by multiple intrachain disulfide bonds.
 - C. Albumin is a glycoprotein.
 - D. Albumin facilitates the movement of fatty acids through the circulation.
 - E. Albumin is the major determinant of plasma osmotic pressure.
14. Select the one of the following statements that is NOT CORRECT:
 - A. Wilson disease can be treated using copper chelators such as penicillamine.
 - B. Wilson disease is characterized by copper toxicosis (abnormally high levels of copper).
 - C. Wilson disease is caused by mutations in the gene encoding ceruloplasmin.
 - D. Albumin facilitates the movement of sulfonamide drugs through the circulation.
 - E. Albumin can be lost from the body if the intestinal mucosa becomes inflamed.
15. You encounter a 50-year-old woman in the clinic who is pale and tired. You suspect that she is suffering from iron deficiency anemia

and prescribe a series of laboratory tests. Select the one of the following potential test outcomes that would NOT be consistent with your provisional diagnosis:

- A. Lower than normal levels of red cell protoporphyrin
 - B. Increased saturation of transferrin
 - C. Increased expression of TfR
 - D. Increased levels of plasma hepcidin
 - E. Decreased levels of hemoglobin
16. Select the one of the following that is NOT a potential cause of amyloidosis:
- A. Accumulation of β_2 -macroglobulin
 - B. Deposition of fragments derived from immunoglobulin light chains
 - C. Accumulation of degradation products of serum amyloid A
 - D. Presence of mutationally altered forms of transthyretin
 - E. Amylase deficiency
17. Select the one of the following statements that is NOT CORRECT:
- A. All immunoglobulins contain at least two heavy-chain polypeptides and two light-chain polypeptides.
 - B. Immunoglobulin polypeptide chains are linked together by disulfide bonds.
 - C. Immunoglobulins are multivalent.
 - D. Immunoglobulins are glycosylated.
 - E. Immunoglobulins are primary components of the body's innate immune system.
18. Explain the linkage how a deficiency in glucose-6-phosphate dehydrogenase within erythrocytes can lead to hemolytic anemia.
19. Select the one of the following statements that is NOT CORRECT:
- A. The high surface area of biconcave red blood cells facilitates gas exchange.
 - B. Hereditary elliptocytosis can be caused by defects in or a deficiency of spectrin.
 - C. The diameter of red blood cells exceeds that of many peripheral

- capillaries.
- D. Protein 4.1 helps link the erythrocyte cytoskeleton to proteins in the cell's plasma membrane.
 - E. In order to pass through narrow capillaries, red blood cells must be squeezed into a compact, spherical shape.
20. Select the one of the following statements that is NOT CORRECT:
- A. Red blood cells contain high levels of superoxide dismutase.
 - B. A and B substances are formed by the addition of fucose and *N*-acetylglucosamine, respectively, to H substance.
 - C. Platelets generate ATP exclusively via glycolysis.
 - D. Mature red blood cells are devoid of internal organelles.
 - E. Erythrocyte membranes contain high levels of the Band 3 anion exchange protein.
21. Select the one of the following statements that is NOT CORRECT:
- A. Erythropoietin stimulates the formation of red blood cells from hematopoietic stem cells.
 - B. Multipotent stem cells are able to differentiate into cells of a closely related type.
 - C. Carbonic anhydrase increases the capacity of red blood cells to transport CO₂.
 - D. GLUT1 mediates the active transport of glucose into erythrocytes.
 - E. Hypoxia stimulates the production of erythropoietin by the kidneys.
22. A patient recently exposed to aniline displays bluish discoloration of their skin and mucous membranes. Select a plausible provisional diagnosis from the list below:
- A. Methemoglobinemia
 - B. Hereditary hemochromatosis
 - C. 5q-syndrome
 - D. Immune thrombocytopenic purpura
 - E. Glanzmann thrombasthenia
23. Select the one of the following statements that is NOT CORRECT:
- A. The accumulation of fluid at a site of infection (edema) facilitates

- leukocyte migration.
- B. Type 1 leukocyte adhesion deficiency is caused a lack of the β_2 subunit an integrin designated LFA-1.
 - C. The components of the complement cascade circulate though the plasma as inactive zymogens.
 - D. Leukocytes are recruited to a site of infection by chemotaxis toward the sources of epinephrine.
 - E. Neutrophils can trap large pathogens in NETS constructed, in part, from strands of chromosomal DNA.
24. Select the one of the following statements that is NOT CORRECT:
- A. Interleukins are key mediators of leukocyte production.
 - B. Lymphocytes produce protective antibodies.
 - C. Monocytes can be found in tissues throughout the body.
 - D. The hematologic factor histamine is synthesized by the deamination of the amino acid histidine.
 - E. The term polymorphonuclear refers to leukocytes possessing a segmented nucleus.
25. Select the one of the following statements that is NOT CORRECT:
- A. Phagocytes destroy ingested bacteria using reactive oxygen species and hydrolytic enzymes.
 - B. Chronic granulomatous disease is caused by a deficiency in myeloperoxidase activity.
 - C. NADPH serves as the primary source of electrons for generating ROS during the oxidative burst.
 - D. Neutrophils aid in the elimination of some parasites by enmeshing them in NETs formed from their chromosomal DNA.
 - E. Chemokines are stabilized by the formation of intrachain disulfide bonds.
26. Select the one of the following statements that is NOT CORRECT:
- A. Activated leukocytes secrete lipid mediators called interferons.
 - B. Neutrophils facilitate production of protective antibodies by presenting fragments of phagocytized microbes on their surface in association with the major histocompatibility complex (MHC).
 - C. Cytotoxic T cells use perforins to lyse infected cells.

- D. Soluble antibodies are released into the plasma primarily by B lymphocytes.
- E. Emphysema can arise from the action of elastase and other granule-derived proteases on pulmonary tissue.
27. Select the one FALSE statement:
- A. The great majority of mitochondrial proteins are encoded by the nuclear genome.
 - B. Ran proteins, like ARF and Ras proteins, are monomeric GTPases.
 - C. One cause of Refsum disease is mutations in genes encoding peroxisomal proteins.
 - D. Peroxisomal proteins are synthesized on cytosolic polyribosomes.
 - E. Import of proteins into mitochondria involves proteins known as importins.
28. Select the one FALSE statement:
- A. *N*-terminal signal peptides directing nascent proteins to the ER membrane contain a hydrophobic sequence.
 - B. Posttranslational translocation of proteins to the ER does not occur in mammalian species.
 - C. The SRP contains one RNA species.
 - D. *N*-glycosylation is catalyzed by oligosaccharide: protein transferase.
 - E. Type I membrane proteins have their *N*-termini facing the lumen of the ER.
29. Select the one FALSE statement:
- A. Chaperones often exhibit ATPase activity.
 - B. Protein disulfide isomerase and peptidyl prolyl isomerase are enzymes involved in helping proteins fold properly.
 - C. Ubiquitin is a small protein involved in protein degradation by lysosomes.
 - D. Mitochondria contain chaperones.
 - E. Retrotranslocation across the ER membrane is involved in helping dispose of misfolded proteins.
30. Select the one FALSE statement:
- A. Rab is a small GTPase involved in vesicle targeting.

- B. COPII vesicles are involved in anterograde transport of cargo from the ER to the ERGIC or Golgi apparatus.
 - C. Brefeldin A prevents GTP binding to ARF, and thus inhibits formation of COPI vesicles.
 - D. Botulinum toxin B acts by cleaving synaptobrevin, inhibiting release of acetylcholine at the neuromuscular junction.
 - E. Furin converts preproalbumin to proalbumin.
31. Which one of the following types of protein does NOT act as a GTPase?
- A. ADP ribosylation factor (ARF)
 - B. Rab proteins
 - C. *N*-ethylmaleimide-sensitive factor (NSF)
 - D. Sar1
 - E. Ran proteins
32. Select the one FALSE statement:
- A. Collagen has a triple helical structure, forming a right-hand superhelix.
 - B. Proline and hydroxyproline confer rigidity on collagen.
 - C. Collagen contains one or more *O*-glycosidic linkages.
 - D. Collagen lacks cross-links.
 - E. Deficiency of vitamin C impairs the action of prolyl and lysyl hydroxylases.
33. Select the one FALSE statement:
- A. Elastin contains hydroxyproline, but not hydroxylysine.
 - B. Elastin contains cross-links formed by desmosines.
 - C. No genetic diseases due to abnormalities of elastin have as yet been identified.
 - D. Unlike collagen, there is only one gene encoding elastin.
 - E. Elastin does not contain any sugar molecules.
34. Select the one FALSE statement:
- A. Marfan syndrome is due to mutations in the gene encoding fibrillin-1, a major constituent of microfibrils.
 - B. All subtypes of Ehlers-Danlos syndrome are due to mutations

- affecting the genes encoding the various types of collagen.
- C. Laminin is found in renal glomeruli along with entactin, type IV collagen, and heparin or heparan sulfate.
 - D. Mutations affecting type IV collagen can cause serious renal disease.
 - E. Mutations in the collagen *1A1* gene can cause osteogenesis imperfecta.
35. Select the one FALSE statement:
- A. Most but not all GAGs contain an amino sugar and a uronic acid.
 - B. All GAGs are sulfated.
 - C. GAGs are built up by the actions of glycosyltransferases using sugars donated by nucleotide sugars.
 - D. Glucuronic acid can be converted to iduronic acid by an epimerase.
 - E. The proteoglycan aggrecan contains hyaluronic acid, keratan sulfate, and chondroitin sulfate.
36. A male infant is failing to thrive and, on examination, is noted to have hepatomegaly and splenomegaly, among other findings. Urinalysis reveals the presence of both dermatan sulfate and heparan sulfate. You suspect the patient has Hurler syndrome. From the following list, select the enzyme that you would wish to have assayed to support your diagnosis:
- A. β -Glucuronidase
 - B. β -Galactosidase
 - C. α -L-Iduronidase
 - D. α -N-Acetylglucosaminidase
 - E. Neuraminidase
37. You see a child in clinic who is well below average height. You note that the child has short limbs, normal trunk size, macrocephaly, and a variety of other skeletal abnormalities. You suspect that the child has achondroplasia. Select from the following list the test that would best confirm your diagnosis:
- A. Measurement of growth hormone
 - B. Assays for enzymes involved in the metabolism of GAGs
 - C. Tests for urinary mucopolysaccharides

- D. Gene tests for abnormalities of the fibroblast growth factor receptor 3 (FGFR3)
- E. Gene tests for abnormalities of growth hormone

SECTION

XI

Special Topics (C)

CHAPTER

55

Hemostasis & Thrombosis

Peter L. Gross, MD, MSc, FRCP(C), P. Anthony Weil, PhD & Margaret L. Rand, PhD

OBJECTIVES

After studying this chapter, you should be able to:

- Understand the significance of hemostasis and thrombosis in health and disease.
- Outline the steps leading to platelet activation.
- Identify antiplatelet drugs and their mode of inhibition.
- Outline the pathways of coagulation that result in the formation of fibrin.
- Identify the vitamin K–dependent coagulation factors.
- Provide examples of genetic disorders that lead to bleeding.

- Describe the process of fibrinolysis.

BIOMEDICAL IMPORTANCE

Fundamental aspects of platelet biology are described in this chapter as well as basic aspects of the proteins of the blood coagulation system and of fibrinolysis. Hemorrhagic and thrombotic states can cause serious medical emergencies, and thromboses in the coronary and cerebral arteries are major causes of death in many parts of the world. Rational management of these conditions requires a clear understanding of the bases of platelet activation, blood coagulation, and fibrinolysis.

HEMOSTASIS & THROMBOSIS HAVE THREE COMMON PHASES

Hemostasis is the cessation of bleeding from a cut or severed vessel, whereas **thrombosis** occurs when the endothelium lining blood vessels is damaged or removed (eg, upon rupture of an atherosclerotic plaque). These processes involve blood vessels, platelet aggregation, and plasma proteins that cause formation or dissolution of platelet aggregates and fibrin.

In hemostasis, there is initial vasoconstriction of the injured vessel, causing diminished blood flow distal to the injury. Then, hemostasis and thrombosis share **three phases**:

1. Formation of a loose and temporary **platelet aggregate** at the site of injury. Platelets bind to collagen at the site of vessel wall injury, form thromboxane A₂ (TxA₂), and release ADP, which activate other platelets flowing by the vicinity of the injury. (The mechanism of platelet activation is described below.) Thrombin, formed during coagulation at the same site, causes further platelet activation. Upon activation, platelets change shape and, in the presence of fibrinogen and/or von Willebrand factor, aggregate to form the hemostatic plug (in hemostasis) or thrombus (in thrombosis).
2. Formation of a **fibrin mesh** that binds to the platelet aggregate forming a more stable hemostatic plug or thrombus.
3. Partial or complete **dissolution** of the hemostatic plug or thrombus by plasmin.

There Are Three Types of Thrombi

Three types of thrombi or clots are distinguished. All three contain **fibrin** in various proportions.

1. The **white thrombus** is composed of platelets and fibrin and is relatively poor in erythrocytes. It forms at the site of an injury or abnormal vessel wall, particularly in areas where blood flow is rapid (arteries).
2. The **red thrombus** consists primarily of red cells and fibrin. It morphologically resembles the clot formed in a test tube and may form in vivo in areas of retarded blood flow or stasis (eg, veins) with or without vascular injury, or it may form at a site of injury or in an abnormal vessel in conjunction with an initiating platelet plug.
3. A third type is **fibrin deposits** in very small blood vessels or capillaries.

We shall first describe some of the aspects of the involvement of platelets and blood vessel walls in the overall process. Then, we shall describe the coagulation pathway leading to the formation of fibrin. This separation of platelets and clotting factors is artificial since both play intimate and often mutually interdependent roles in hemostasis and thrombosis; this strategy facilitates description of the overall processes involved.

Platelet Aggregation Requires Outside-In and Inside-Out Transmembrane Signaling

Platelets normally circulate in an unstimulated disk-shaped form. **During hemostasis or thrombosis, platelets become activated** and help **form hemostatic plugs or thrombi (Figure 55–1)**. Three major steps are involved: (1) adhesion to exposed collagen in blood vessels; (2) release (exocytosis) of the contents of their storage granules; and (3) aggregation.

A

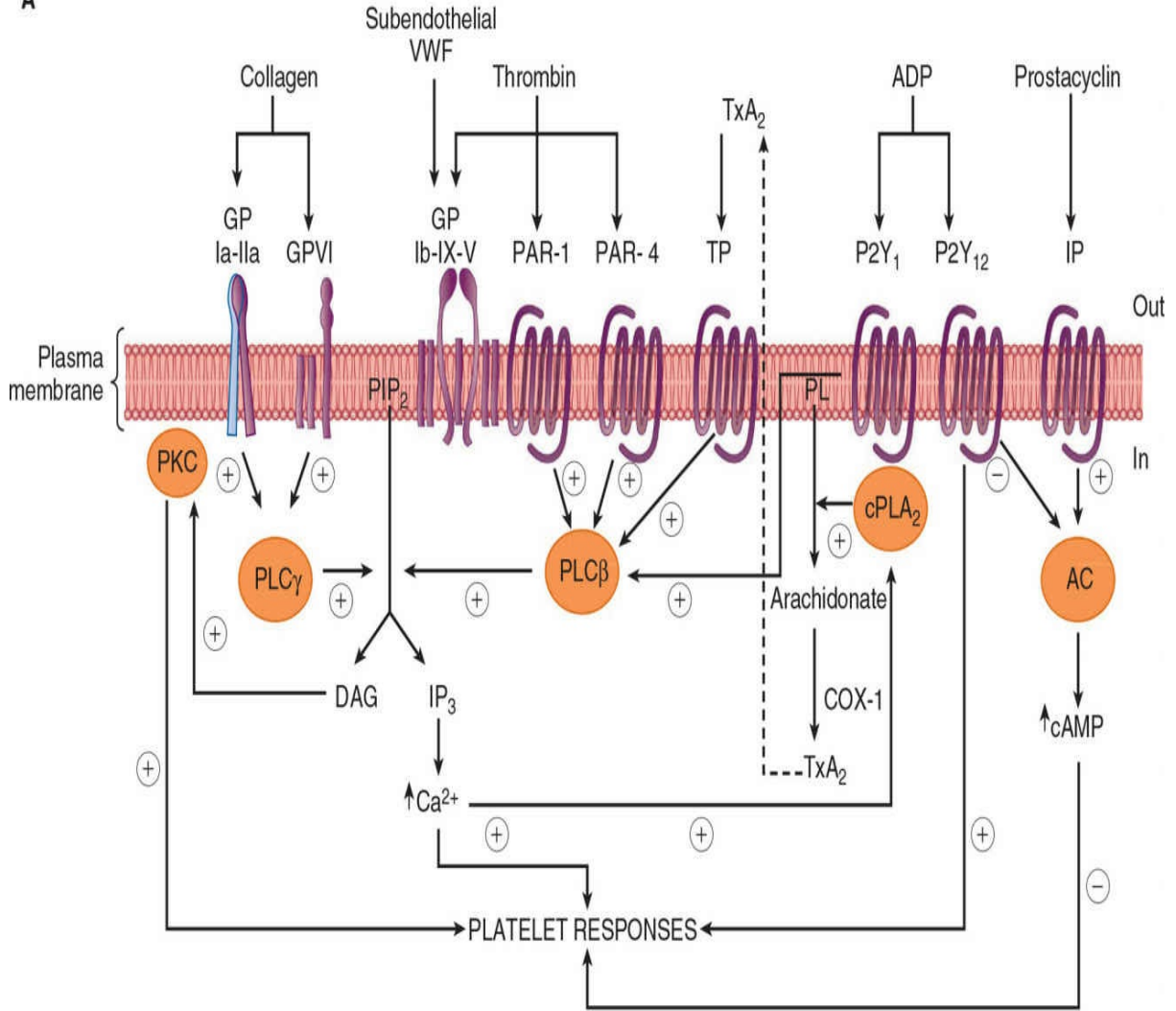

B

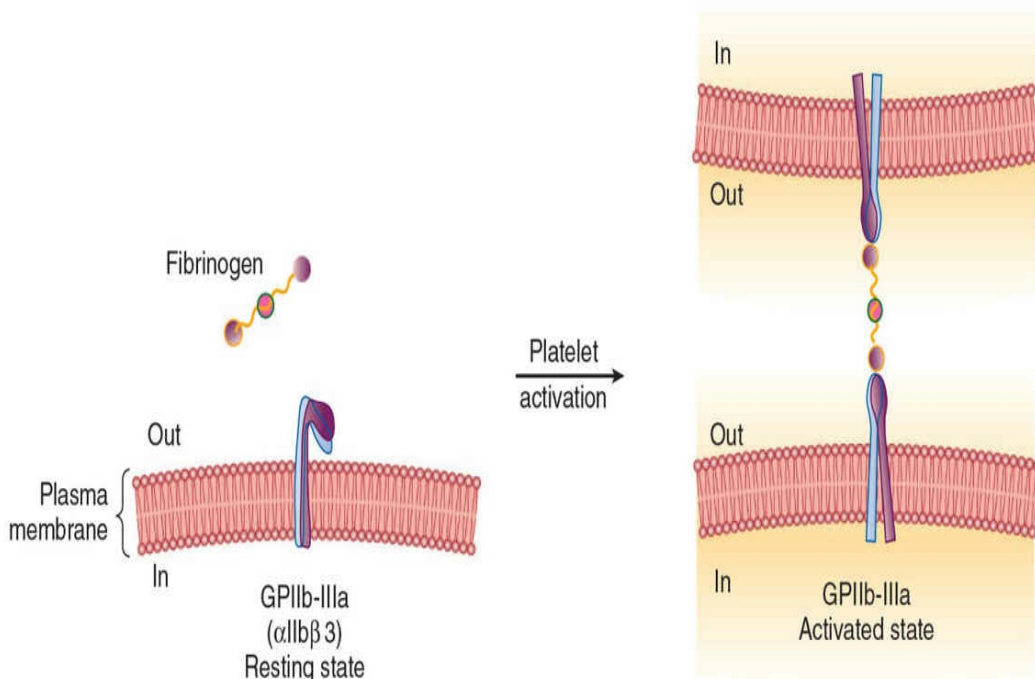

FIGURE 55–1 (A) Diagrammatic representation of platelet activation by collagen, thrombin, thromboxane A₂ and ADP, and inhibition by prostacyclin. The external environment (Out), the plasma membrane, and the inside of a platelet (In) are depicted from top to bottom. Platelet responses include, depending on the agonist, change of platelet shape, release of the contents of the storage granules, and aggregation. (AC, adenylyl cyclase; cAMP, cyclic AMP; COX-1, cyclooxygenase-1; cPLA₂, cytosolic phospholipase A₂; DAG, 1,2-diacylglycerol; GP, glycoprotein; IP, prostacyclin receptor; IP₃, inositol 1,4,5-trisphosphate; P2Y₁, P2Y₁₂, purinoceptors; PAR, protease activated receptor; PIP₂, phosphatidylinositol 4,5-bisphosphate; PKC, protein kinase C; PL, phospholipid; PLCβ, phospholipase Cβ; PLCγ, phospholipase Cγ; TP, thromboxane A₂ receptor; TxA₂, thromboxane A₂; VWF, von Willebrand factor.) The G-proteins that are involved are not shown. **(B) Diagrammatic representation of platelet aggregation mediated by fibrinogen binding to activated GPIIb-IIIa molecules on adjacent platelets.** Signaling events initiated by all aggregating agents transform GPIIb-IIIa from its resting state to an activated form that can bind divalent fibrinogen or, at the high shear that occurs in small vessels, multivalent von Willebrand factor.

Platelets adhere to collagen via specific receptors on the platelet surface, including the glycoprotein complexes GPIa-IIa (α₂β₁ integrin; see [Chapter 54](#)) and GPIb-IX-V, and GPVI. The binding of GPIb-IX-V to collagen is mediated via von Willebrand factor; this interaction is especially important in platelet adherence to the subendothelium under conditions of high shear stress that occur in small vessels and partially stenosed arteries.

Platelets that are bound to collagen change shape and spread out on the subendothelium. These adherent platelets release the contents of their **storage granules** (the dense granules and the alpha granules); some of the molecules released amplify the responses to vessel wall injury. Granule release is also stimulated by thrombin.

Thrombin, formed from the coagulation cascade (described below), is the most potent activator of platelets and initiates activation by interacting with its receptors **protease-activated receptor-1 (PAR-1)**, **PAR-4**, and **GPIb-IX-V** on the platelet plasma membrane ([Figure 55–1A](#)). The further events leading to platelet activation upon binding to PAR-1 and PAR-4 are

examples of **outside-in transmembrane signaling**, in which a chemical messenger outside the cell generates effector molecules inside the cell (see [Chapter 42](#)). In this instance, thrombin acts as the external chemical messenger (stimulus or agonist). The interaction of thrombin with its G-protein–coupled receptors PAR-1 and PAR-4 stimulates the activity of an intracellular **phospholipase C β (PLC β)**. This enzyme hydrolyzes the membrane phospholipid **phosphatidylinositol 4,5-bisphosphate (PIP₂**, a polyphosphoinositide) to form the two internal effector molecules (**1,2-diaclycerol [DAG]** and **1,4,5-inositol trisphosphate [IP₃]**); see [Figures 42–6 and 42–7](#)).

Hydrolysis of PIP₂ is also involved in the action of many hormones and drugs. DAG stimulates **protein kinase C**, which phosphorylates the protein **pleckstrin** (47 kDa). This results in aggregation and release of the contents of the storage granules. **ADP** released from dense granules can also activate platelets via its specific G-protein–coupled receptors ([Figure 55–1A](#)), resulting in aggregation of additional platelets. **IP₃** causes release of Ca²⁺ into the cytosol mainly from the dense tubular system (or residual smooth endoplasmic reticulum from the megakaryocyte), which then interacts with calmodulin and myosin light-chain kinase, leading to phosphorylation of the light chains of myosin. These chains then interact with actin, causing changes of platelet shape.

Collagen-induced activation of a platelet **cytosolic phospholipase A₂** (cPLA₂) by increased levels of intracellular Ca²⁺ results in liberation of arachidonic acid from platelet membrane phospholipids, leading to the formation of **TxA₂** (see [Chapters 21 and 23](#)). TxA₂, in turn, by binding to its specific G-protein–coupled receptor, can further activate PLC β , promoting platelet aggregation ([Figure 55–1A](#)).

All of the **aggregating agents**, including thrombin, collagen, ADP, and others such as platelet-activating factor, via an **inside-out signaling pathway**, modify the platelet surface **glycoprotein complex GPIIb-IIIa** (α IIb β 3 integrin; see [Chapters 54](#)) so that the receptor has a higher affinity for **fibrinogen** or **von Willebrand factor** ([Figure 55–1B](#)). Molecules of divalent fibrinogen or multivalent von Willebrand factor then link adjacent activated platelets to each other, forming a platelet aggregate. von Willebrand factor–mediated platelet aggregation occurs under conditions of high shear stress. Some agents, including epinephrine, serotonin, and vasopressin, exert synergistic effects with other aggregating agents.

Activated platelets, besides forming a platelet aggregate, accelerate the activation of the coagulation factor X and prothrombin by exposing the

anionic phospholipid phosphatidylserine on their membrane surface (see below for more detail). Polyphosphate, released from the dense granules, accelerates factor V activation and also accelerates factor XI activation by thrombin.

Endothelial Cells Synthesize Prostacyclin & Other Compounds That Affect Clotting & Thrombosis

The **endothelial cells** in the walls of blood vessels make important contributions to the overall regulation of hemostasis and thrombosis. As described in [Chapter 23](#), these cells synthesize the prostanoid **prostacyclin** (PGI₂), a potent inhibitor of platelet aggregation. Prostacyclin acts by stimulating the activity of adenylyl cyclase in the surface membranes of platelets via its G protein–coupled receptor ([Figure 55–1A](#)). The resulting increase of intraplatelet **cAMP** opposes the increase in the level of intracellular Ca²⁺ produced by IP₃ and thus inhibits platelet activation. This is in contrast with the effect of the prostanoid TxA₂ that is formed by activated platelets, which is that of promoting aggregation. Endothelial cells play other roles in the regulation of thrombosis. For instance, these cells possess an **ADPase**, which hydrolyzes ADP, and thus opposes its aggregating effect on platelets. In addition, these cells express proteoglycans such as **heparan sulfate**, an anticoagulant, and they also release **plasminogen activators**, which may help dissolve thrombi. **Nitric oxide** (endothelium-derived relaxing factor), another potent platelet inhibitor, is discussed in [Chapter 51](#).

Aspirin Is One of Several Effective Antiplatelet Drugs

Antiplatelet drugs inhibit platelet responses. The most commonly used antiplatelet drug is **aspirin (acetylsalicylic acid)**, which irreversibly acetylates and thus inhibits the platelet **cyclooxygenase (COX-1)** involved in formation of TxA₂ (see [Chapter 21](#)); TxA₂ is a potent aggregator of platelets and also a vasoconstrictor. Platelets are very sensitive to aspirin; as little as 30 mg of aspirin/day (one regular aspirin tablet contains 325 mg) effectively eliminates the synthesis of TxA₂ by platelets. Aspirin also inhibits production of PGI₂, which opposes platelet aggregation and is a vasodilator, by endothelial cells, but unlike platelets, these cells regenerate cyclooxygenase within a few hours. Thus, the overall balance between TxA₂ and PGI₂ can be shifted in favor of the latter, opposing platelet

aggregation. Indications for treatment with aspirin include management of acute coronary syndromes (angina, myocardial infarction), acute stroke syndromes (transient ischemic attacks, acute stroke), severe carotid artery stenosis, and primary prevention of these and other atherothrombotic diseases.

Other **antiplatelet drugs** include specific inhibitors of the P2Y₁₂ receptor for ADP (eg, **clopidogrel**, **prasugrel**, and **ticagrelor**) and antagonists of ligand binding to GPIIb-IIIa (eg, **abciximab**, **eptifibatide**, and **tirofiban**) that interfere with fibrinogen and von Willebrand factor binding and thus platelet aggregation.

Both Extrinsic & Intrinsic Pathways Result in the Formation of Fibrin

Two pathways lead to **fibrin clot** formation: the **extrinsic** and the **intrinsic** pathways. These pathways are not independent, as previously thought. However, this artificial distinction is retained in the following text to facilitate their description.

Initiation of fibrin clot formation in response to **tissue injury** is carried out by the **extrinsic pathway**. The **intrinsic pathway** can be activated by negatively charged surfaces **in vitro**, for example, glass. Both pathways lead to the proteolytic conversion of **prothrombin** to **thrombin**. Thrombin catalyzes cleavage of **fibrinogen** to initiate **fibrin** clot formation. The extrinsic and intrinsic pathways are complex and involve many different proteins (**Figures 55–2** and **55–3**; **Table 55–1**). The coagulation factors are another example of multidomain proteins sharing conserved domains (see **Figure 5–9**). In general, as shown in **Table 55–2**, these proteins can be classified into **five types**: (1) zymogens of serine-dependent proteases that are activated during the process of coagulation; (2) cofactors; (3) fibrinogen; (4) a zymogen of a transglutaminase that covalently cross-links fibrin and stabilizes the fibrin clot; and (5) regulatory and other proteins.

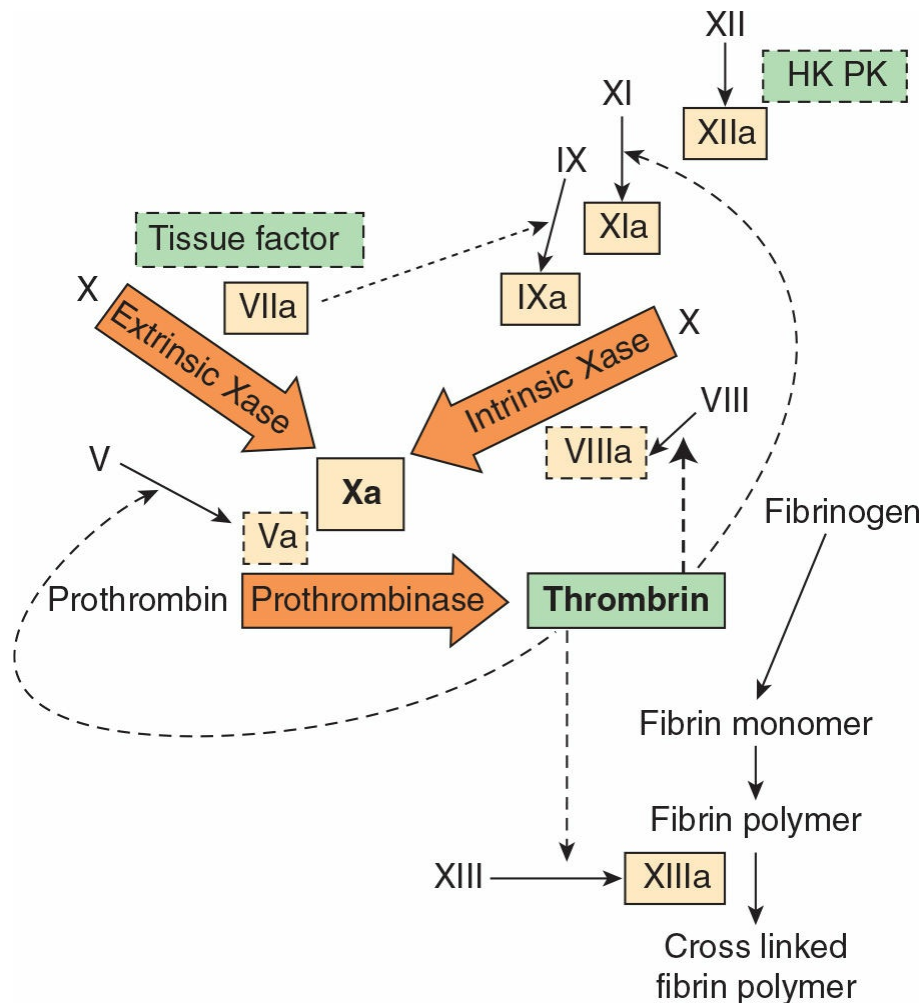

FIGURE 55–2 The pathways of blood coagulation, with the extrinsic pathway indicated at the top left and the intrinsic pathway at the top right. The pathways converge in the formation of active factor X (ie. factor Xa) and culminate in the formation of cross-linked fibrin (lower right). Complexes of tissue factor and factor VIIa activate not only factor X (extrinsic Xase [tenase]) but also factor IX in the intrinsic pathway (dotted arrow). In addition, thrombin feedback activates at the sites indicated (dashed arrows) and also activates factor VII to factor VIIa (not shown). The three predominant complexes, extrinsic Xase, intrinsic Xase, and prothrombinase, are indicated within the large arrows; these reactions require anionic procoagulant phospholipid membrane and calcium. Activated proteases are in solid-outlined boxes; active cofactors are in dash-outlined boxes; and inactive factors are not in boxes. (HK, high-molecular-weight kininogen; PK, prekallikrein.)

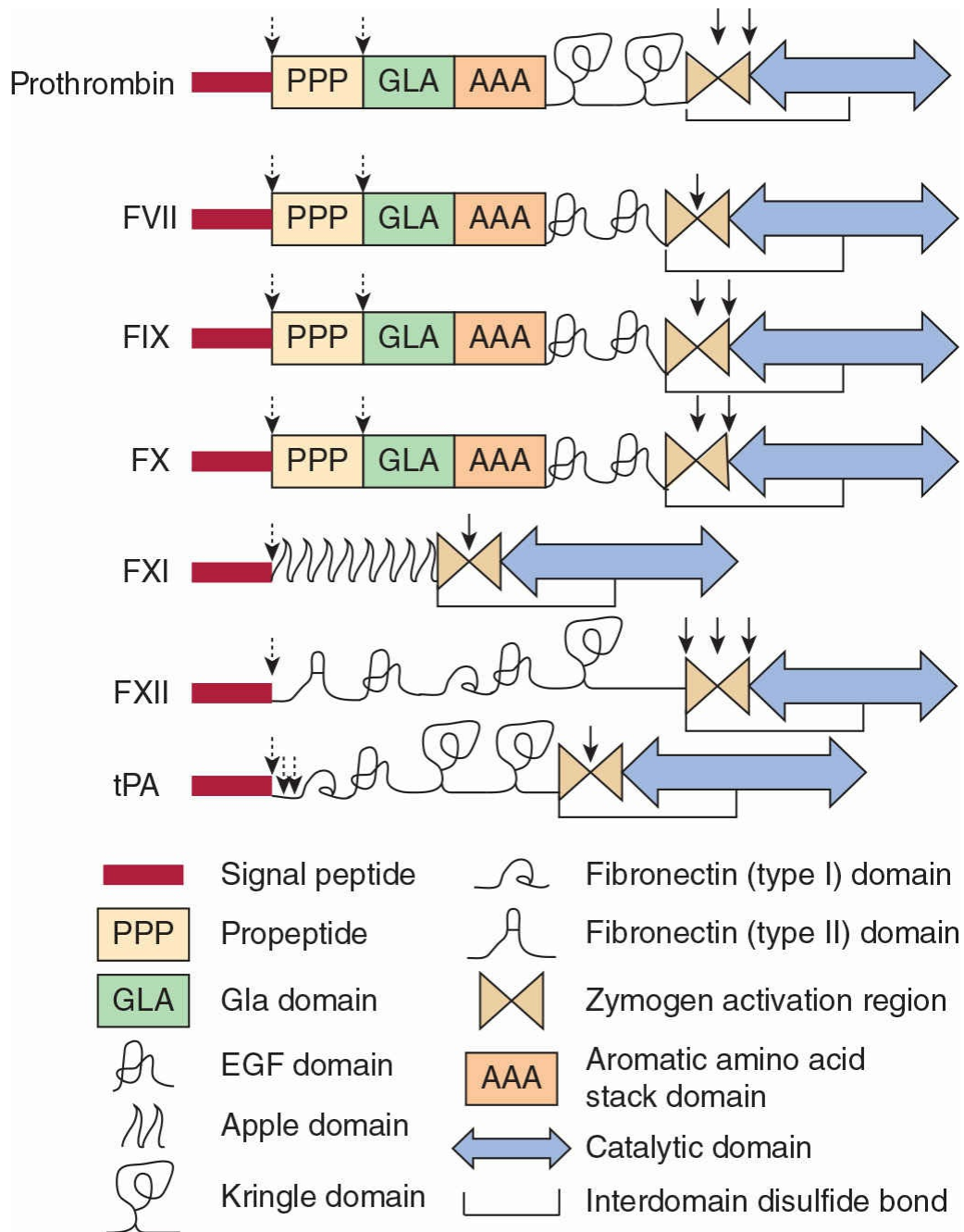

FIGURE 55–3 The structural domains of selected proteins involved in coagulation and fibrinolysis. Shared domains are a result of gene duplication and exon shuffling that contributed to the molecular evolution of the coagulation system. The domains are as identified at the bottom of the figure and include signal peptide, propeptide, Gla (γ -carboxyglutamate) domain, epidermal growth factor (EGF) domain, apple domain, kringle domain, fibronectin (types I and II) domain, the zymogen activation region, aromatic amino acid stack, and the catalytic domain. Interdomain disulfide bonds are indicated, but numerous intradomain disulfide bonds are not. Sites of proteolytic cleavage in synthesis or

activation are indicated by arrows (dashed and solid, respectively). (FVII, factor VII; FIX, factor IX; FX, factor X, FXI; factor XI; FXII, factor XII; t-PA, tissue plasminogen activator.) (Adapted, with permission, from Furie B, Furie BC: The molecular basis of blood coagulation. Cell 1988;53:505.)

TABLE 55–1 Numerical System for Nomenclature of Blood Clotting Factors

Factor	Common Name(s)	
I	Fibrinogen	} These factors are usually referred to by their common names
II	Prothrombin	
III	Tissue factor	
IV	Ca ²⁺	Ca ²⁺ is usually not referred to as a coagulation factor
V	Proaccelerin, labile factor, accelerator (Ac-) globulin	
VII ^a	Proconvertin, serum prothrombin conversion accelerator (SPCA), cothromboplastin	
VIII	Antihemophilic factor A, antihemophilic globulin (AHG)	
IX	Antihemophilic factor B, Christmas factor, plasma thromboplastin component (PTC)	
X	Stuart-Prower factor	
XI	Plasma thromboplastin antecedent (PTA)	
XII	Hageman factor	
XIII	Fibrin stabilizing factor (FSF), fibrinolygase	

TABLE 55–2 The Functions of the Proteins Involved in Blood Coagulation

Zymogens of Serine Proteases	
Factor XII	Binds to negatively charged surface, eg, kaolin, glass; activated by high-molecular-weight kininogen and kallikrein
Factor XI	Activated by factor XIIa
Factor IX	Activated by factors XIa and VIIa
Factor VII	Activated by factor VIIa and thrombin
Factor X	Activated on the surface of activated platelets by tenase complex (Ca^{2+} , factors VIIIa and IXa) and by the extrinsic tenase complex (Ca^{2+} , tissue factor, and factor VIIa)
Prothrombin (Factor II)	Activated on the surface of activated platelets by prothrombinase complex (Ca^{2+} , factors Va and Xa) to form thrombin (Factors II, VII, IX, and X are Gla-containing zymogens) (Gla = γ -carboxyglutamate)
Cofactors	
Factor VIII	Activated by thrombin; factor VIIIa is a cofactor in the activation of factor X by factor IXa
Factor V	Activated by thrombin; factor Va is a cofactor in the activation of prothrombin by factor Xa
Tissue factor (factor III)	A glycoprotein located in the subendothelium and expressed on activated monocytes to act as a cofactor for factor VIIa
Fibrinogen	
Factor I	Cleaved by thrombin to form fibrin clot
Zymogen of a Thiol-Dependent Transglutaminase	
Factor XIII	Activated by thrombin; stabilizes fibrin clot by covalent cross-linking
Regulatory and Other Proteins	
Protein C	Activated to activated protein C (APC) by thrombin bound to thrombomodulin; then degrades factors VIIIa and Va
Protein S	Acts as a cofactor of protein C; both proteins contain Gla (γ -carboxyglutamate) residues
Thrombomodulin	Protein on the surface of endothelial cells; binds thrombin, which then activates protein C

The Extrinsic Pathway Leads to Activation of Factor X

The **extrinsic pathway** involves tissue factor, factors VII and X, and Ca^{2+} and results in the production of factor Xa (by convention, activated clotting factors are referred to by use of the suffix a). The extrinsic pathway is initiated at the site of **tissue injury** with the exposure of **tissue factor (TF; Figure 55–2)**, located in the subendothelium and on activated monocytes. TF interacts with and activates **factor VII** (53 kDa, a zymogen-containing vitamin K–dependent γ -carboxyglutamate [Gla]

residues; see [Chapter 44](#)), synthesized in the liver. It should be noted that in the Gla-containing zymogens (factors II, VII, IX, and X), the Gla residues in the amino-terminal regions of the molecules serve as high-affinity binding sites for Ca^{2+} . TF acts as a cofactor for **factor VIIa**, enhancing its enzymatic activity to activate **factor X** (56 kDa). The reaction by which **factor X** is activated requires the assembly of the **extrinsic tenase complex (Ca^{2+} -TF-factor VIIa)** formed on a cell membrane surface exposing the procoagulant anionic aminophospholipid phosphatidylserine. Factor VIIa cleaves an Arg-Ile bond in factor X to produce the two-chain serine protease, **factor Xa**. TF and factor VIIa also activate factor IX in the intrinsic pathway. Indeed, **the formation of complexes between membrane-bound TF and factor VIIa is now considered to be the key process involved in initiation of blood coagulation in vivo.**

Tissue factor pathway inhibitor (TFPI) is a major physiologic inhibitor of coagulation. TFPI is a protein that circulates in the blood where it directly inhibits factor Xa by binding to the enzyme near its active site. This factor Xa-TFPI complex then inhibits the factor VIIa-TF complex.

The Intrinsic Pathway Also Leads to Activation of Factor X

The formation of **factor Xa** is the major site where the intrinsic and extrinsic pathways converge ([Figure 55–2](#)). The **intrinsic pathway** ([Figure 55–2](#)) involves factors XII, XI, IX, VIII, and X, as well as prekallikrein, high-molecular-weight (HMW) kininogen, Ca^{2+} , and cell surface exposed phosphatidylserine. This pathway results in the production of **factor Xa** by the intrinsic tenase complex (see below for composition), in which factor IXa serves as the serine protease and factor VIIIa as the cofactor. As noted above, the activation of **factor X provides an important link between the intrinsic and extrinsic pathways.**

The **intrinsic pathway** can be initiated by “contact” in which prekallikrein, HMW kininogen, factors XII and XI are exposed to a negatively charged activating surface. In vivo, polymers of phosphates, such as extracellular DNA, RNA, and polyphosphate (macromolecules available only following cell damage) may serve as this negatively charged activating surface. Kaolin, a highly negatively charged hydrated aluminum silicate, can be used for in vitro tests as an initiator of the intrinsic

pathway. When the components of the contact phase assemble on the activating surface, factor XII is activated to **factor XIIa** upon proteolysis by kallikrein. This factor XIIa, generated by kallikrein, cleaves prekallikrein to generate more kallikrein, setting up a positive feedback activation loop. Factor XIIa, once formed, activates **factor XI** to **XIa** and also releases **bradykinin** (a peptide with potent vasodilator action) from HMW kininogen.

In the presence of Ca^{2+} , factor XIa activates factor IX (55 kDa, a Gla-containing zymogen), to the serine protease, **factor IXa**. This, in turn, also cleaves an Arg-Ile bond in factor X to produce **factor Xa**. This latter reaction requires the assembly of components, called **the intrinsic tenase complex, composed of Ca^{2+} -factor VIIIa-factor IXa**, which forms on procoagulant membrane surfaces expressing phosphatidylserine, often activated platelets. (Note that this phospholipid is normally on the inner leaflet side of the plasma membrane bilayer of resting, nonactivated platelets.)

Factor VIII (330 kDa), a circulating glycoprotein, is not a protease precursor but a cofactor precursor that, when activated, serves as a receptor on the platelet surface for factors IXa and X. Factor VIII is activated by minute quantities of thrombin to form **factor VIIIa**, which is in turn inactivated upon further cleavage by thrombin-mediated activated protein C (see below).

The role of the **initial steps of the intrinsic pathway** in initiating coagulation has been called into question because patients with a hereditary deficiency of factor XII, prekallikrein or HMW kininogen do not exhibit bleeding problems. Similarly, patients with a deficiency of factor XI may not have bleeding problems. In thrombosis, deficiencies in the intrinsic pathway are protective. The intrinsic pathway largely serves to **amplify factor Xa** and ultimately **thrombin formation**, through feedback mechanisms (see below). The intrinsic pathway may also be important in **fibrinolysis** (see below) since kallikrein, factors XIIa and XIa can cleave plasminogen and kallikrein can activate single-chain urokinase.

Factor Xa Leads to Activation of Prothrombin to Thrombin

Factor Xa, produced by either the extrinsic or the intrinsic pathway, activates **prothrombin** (factor II) to **thrombin** (factor IIa) ([Figure 55–2](#); [Table 55-1](#)).

The activation of prothrombin, like that of factor X, occurs on a membrane surface and requires the assembly of a **prothrombinase complex**, consisting of Ca^{2+} , and factors Va and Xa. The assembly of the prothrombinase complex, like that of the tenase complex, takes place on the phosphatidylserine-exposing membrane surface, often activated platelets.

Factor V (330 kDa) is synthesized in the liver, spleen, and kidney and is found in platelets as well as in plasma. Factor Va functions as a cofactor in a manner similar to that of factor VIIIa in the tenase complex. Factor V is activated to **factor Va** by traces of thrombin, and binds specifically to a procoagulant membrane (often that of platelets) (**Figure 55–4**) and forms a complex with factor Xa and prothrombin. It is subsequently inactivated by activated protein C (see below), thereby providing a means of limiting the activation of prothrombin to thrombin. **Prothrombin** (72 kDa; **Figure 55–4**) is a single-chain glycoprotein synthesized in the liver. The amino-terminal region of prothrombin (**Figure 55–3**) contains 10 Glu residues, and the serine-dependent active protease site is in the catalytic domain close to the carboxyl-terminal region of the molecule. Upon binding to the complex of factors Va and Xa on the procoagulant membrane (**Figure 55–4**), prothrombin is cleaved by factor Xa at two sites to generate the active, two-chain thrombin molecule, which is then released from the membrane surface.

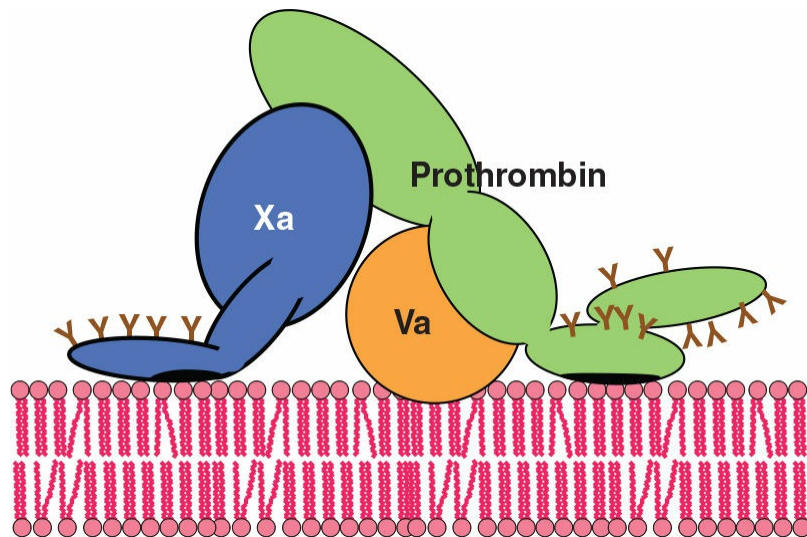

FIGURE 55–4 Schematic representation of the prothrombinase complex bound to the procoagulant plasma membrane. The prothrombinase complex contains factors Va, Xa, and prothrombin. A central theme in blood coagulation is the assembly of protein complexes,

that is, the tenase complexes and the prothrombinase complex, in a Ca^{2+} -dependent fashion, on membrane surfaces on which phosphatidylserine is exposed. The catalytic efficiency of zymogen activation is increased by many orders of magnitude by the membrane-bound complexes. γ -carboxyglutamate residues (indicated by **Y**) on vitamin K–dependent proteins bind calcium and contribute to the exposure of membrane-binding sites on these proteins (black ovals, Xa and prothrombinase).

Conversion of Fibrinogen to Fibrin Is Catalyzed by Thrombin

Thrombin, produced by the prothrombinase complex, in addition to having a potent stimulatory effect on platelets (see above), **converts fibrinogen to fibrin** (Figure 55–2). **Fibrinogen** (factor I, 340 kDa; see Figure 55–2 and Figure 55–5; Tables 55–1 and 55–2) is an abundant (3 mg/mL) soluble plasma glycoprotein that consists of a dimer of three polypeptide chains, (**A** α , **B** β , γ)₂, that is covalently linked by 29 disulfide bonds. The **B** β and γ chains contain asparagine-linked complex oligosaccharides (see Chapter 46). All three chains are synthesized in the liver; the three genes encoding these proteins are on the same chromosome where their expression is coordinately regulated in humans. The amino-terminal regions of the six chains are held in close proximity by a number of disulfide bonds (a subset is shown in Figure 55–5), while the carboxyl-terminal regions are spread apart. Thus, the fibrinogen molecule has a trinodular, elongated structure with a central E domain that is linked to lateral D domains via coiled coil regions (Figure 55-5 and Figure 55-6A). The **N-terminal A** and **B** portions of the **A** α and **B** β chains are termed **fibrinopeptide A (FPA)** and **fibrinopeptide B (FPB)**, respectively; these domains are highly negatively charged as a result of an abundance of aspartate and glutamate residues (see below). The negative charges contribute to the solubility of fibrinogen in plasma and importantly also serve to prevent aggregation by causing electrostatic repulsion between fibrinogen molecules.

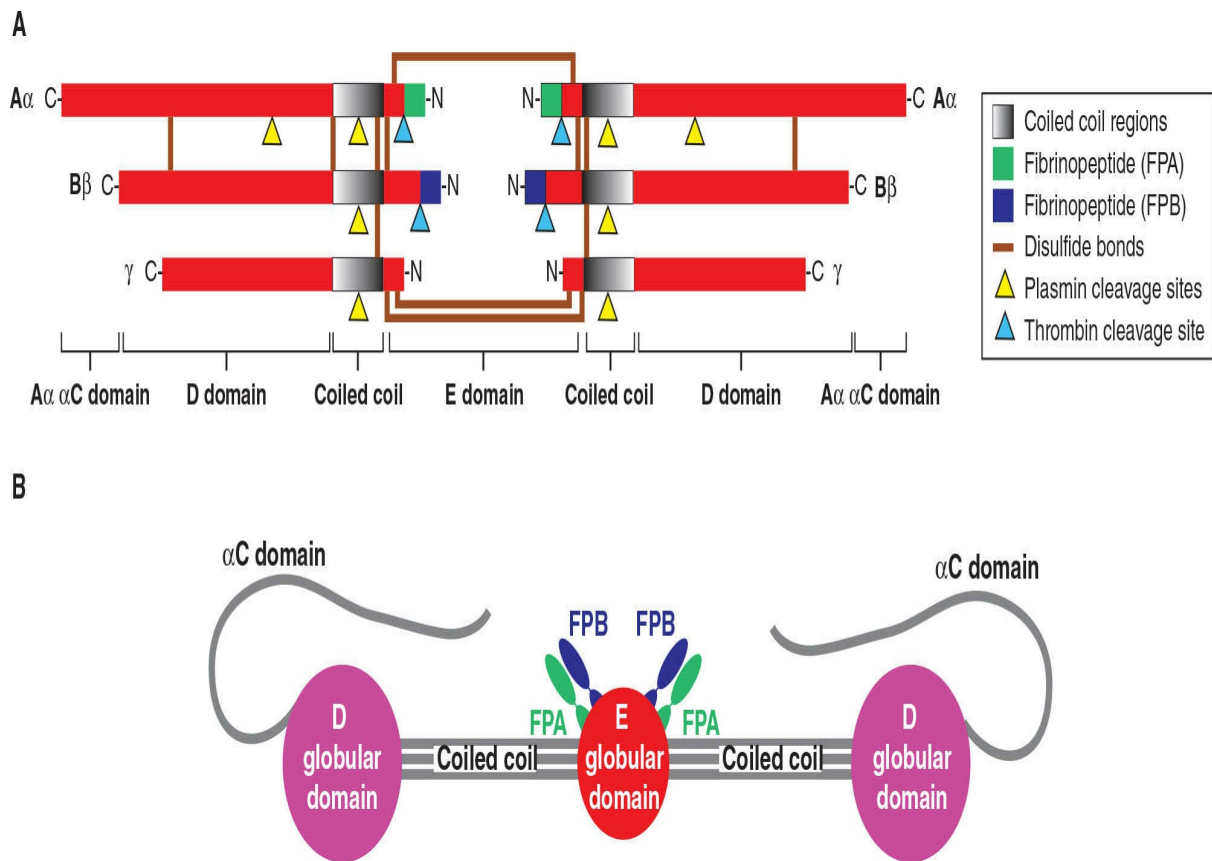
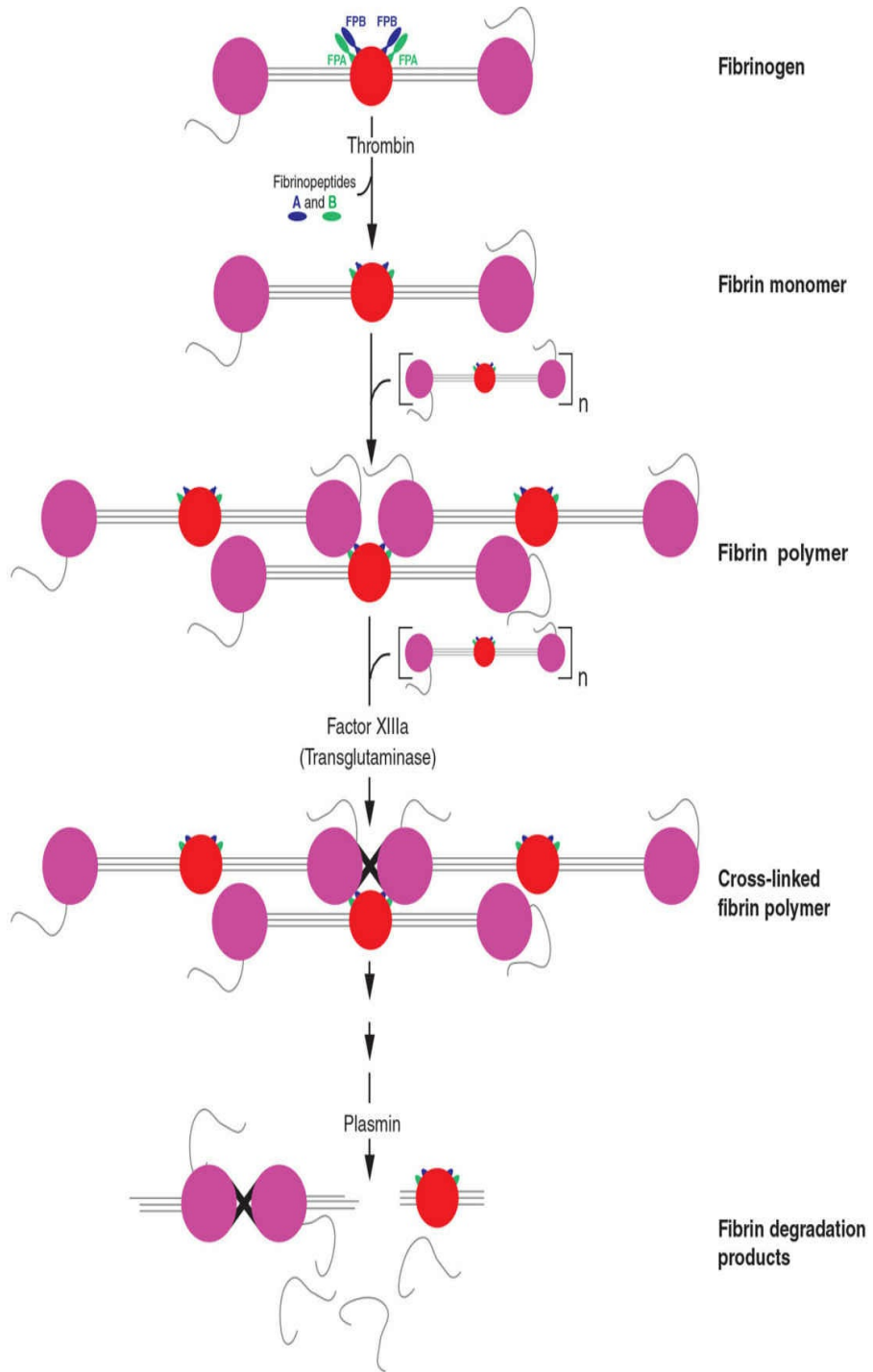
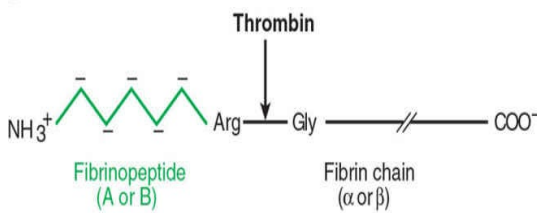

FIGURE 55–5 Diagrammatic representation of fibrinogen. (A) Fibrinogen is a dimeric molecule, with each half composed of three polypeptide chains: $A\alpha$, $B\beta$, and γ . Disulfide bonds join together the chains and the two halves of the molecule. **(B)** Fibrinogen forms a trinodular structure with a central E domain linked via coiled coil regions to two lateral D domains each of which contains a flexible $A\alpha$ chain αC domain. The thrombin-cleaved regulatory peptides fibrinopeptide A (FPA) and fibrinopeptide B (FPB) reside within the E nodule as shown.

A



B



C

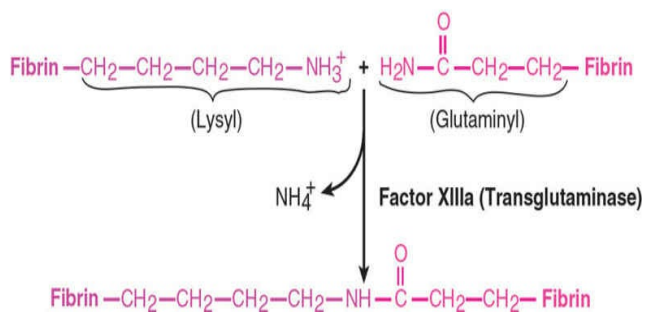

FIGURE 55–6 Fibrin polymerization and degradation. (A) The formation of fibrin monomer via cleavage of fibrinopeptide A (FPA) and fibrinopeptide B (FPB) from fibrinogen by thrombin, the spontaneous polymerization of fibrin monomers to dimers and higher oligomers, followed by the stabilization of fibrin oligomers by factor XIIIa-mediated covalent cross-linking of adjacent fibrin monomers. Finally (bottom) is illustrated the degradation of fibrin polymers into soluble degradation products by plasmin digestion, which leads to clot dissolution. (B) Thrombin cleavage site of the A α and B β chains of fibrinogen to yield FPA/FPB (left; green) and the α and β chains of fibrin monomer (right; black). (C) Schematic of factor XIIIa (transglutaminase)-mediated cross-linking of fibrin molecules.

Thrombin (34 kDa), the serine protease formed by the prothrombinase complex, hydrolyzes the four Arg-Gly bonds between the N-terminal fibrinopeptides and the α and β portions of the A α and B β chains of fibrinogen (Figure 55–6A, B). The release of FPA and FPB by thrombin generates **fibrin monomer**, which has the subunit structure (α , β , γ)₂. Since FPA and FPB contain only 16 and 14 residues, respectively, the fibrin molecule retains 98% of the residues present in fibrinogen. The removal of the fibrinopeptides exposes binding sites within the E domain of fibrin monomers that specifically interact with complementary domains within the D domains of other fibrin monomers. In this way, fibrin monomers spontaneously polymerize in a half-staggered pattern to form long strands (protofibrils) (Figure 55–6A). Although insoluble, this initial fibrin clot is unstable, held together only by the noncovalent association of fibrin monomers.

In addition to converting fibrinogen to fibrin, thrombin also activates **factor XIII to factor XIIIa**. Factor XIIIa is a highly specific **transglutaminase** that covalently cross-links γ chains and, more slowly, α chains of fibrin molecules by forming peptide bonds between the amide groups of glutamine and the ϵ -amino groups of lysine residues (Figure 55–6C). Such cross-linking yields a more stable fibrin clot with increased resistance to proteolysis. This fibrin mesh serves to stabilize the hemostatic plug or thrombus.

Levels of Circulating Thrombin Are Carefully Controlled

Once active thrombin is formed in the course of hemostasis or thrombosis, its concentration must be carefully controlled to prevent further fibrin formation or platelet activation. This is achieved in **two ways**. Thrombin circulates as its inactive precursor, prothrombin, which is activated as a result of a cascade of enzymatic reactions, each converting an inactive zymogen to an active enzyme and leading finally to the conversion of prothrombin to thrombin (Figure 55–2). At each point in the cascade, **feedback mechanisms** produce a delicate balance of activation and inhibition. The concentration of factor XII in plasma is approximately 30 $\mu\text{g/mL}$, while that of fibrinogen is 3 mg/mL , with intermediate clotting factors increasing in concentration as one proceeds down the cascade; these facts illustrate that the clotting cascade provides **amplification**. The second means of controlling thrombin activity is **the inactivation of any formed thrombin** by **circulating inhibitors**, the most important of which is antithrombin (see below).

The Activity of Antithrombin, an Inhibitor of Thrombin, Is Increased by Heparin

Four naturally occurring **thrombin inhibitors** exist in normal plasma. The most important is **antithrombin**, which contributes approximately 75% of the antithrombin activity. Antithrombin can also inhibit the activities of factors IXa, Xa, XIa, XIIa, and VIIa complexed with tissue factor. **α_2 -Macroglobulin** contributes most of the remainder of the antithrombin activity, with **heparin cofactor II** and **α_1 -antitrypsin** acting as minor inhibitors under physiologic conditions.

The endogenous activity of antithrombin is greatly potentiated by the presence of sulfated glycosaminoglycans (heparans) (see Chapter 50). Heparans bind to a specific cationic site of antithrombin, which induces a conformational change that promotes binding of antithrombin to thrombin and factor Xa, as well as to its other substrates. This mechanism is the basis for the use of **heparin**, a derivatized heparan, in clinical medicine to inhibit coagulation. The anticoagulant effects of heparin can be antagonized by strongly cationic polypeptides such as **protamine**, which bind strongly to heparin, thus inhibiting the binding of heparin to antithrombin.

Low-molecular-weight heparins (LMWHs), derived from enzymatic or chemical cleavage of unfractionated heparin, have more clinical use. They can be administered subcutaneously at home, have greater

bioavailability than unfractionated heparin, and do not need frequent laboratory monitoring.

Individuals with **inherited deficiencies of antithrombin** are prone to develop venous thrombosis, providing evidence that antithrombin has a physiologic function and that the coagulation system in humans is normally in a dynamic state.

Thrombin is involved in an additional regulatory mechanism that operates in coagulation. It combines with **thrombomodulin**, a glycoprotein present on the surfaces of endothelial cells. The complex activates **protein C** on the **endothelial protein C receptor**. In combination with **protein S**, **activated protein C (APC)** degrades factors Va and VIIIa, thereby limiting their actions in coagulation. A genetic deficiency of either protein C or protein S can cause venous thrombosis. Furthermore, patients with **factor V Leiden** (which has a glutamine residue in place of an arginine at position 506) have an increased risk of venous thrombotic disease because factor V Leiden is resistant to inactivation by APC; this condition is also termed APC resistance.

Coumarin Anticoagulants Inhibit the Vitamin K–Dependent Carboxylation of Factors II, VII, IX, & X

The **coumarin drugs** (eg, warfarin), which are used as anticoagulants, inhibit the vitamin K–dependent carboxylation of Glu to Gla residues (see [Chapter 44](#)) in the amino-terminal regions of factors II, VII, IX, and X and also proteins C and S. These proteins, all of which are synthesized in the liver, are dependent on the Ca^{2+} -binding properties of the Gla residues for their normal function in the coagulation pathways. **Coumarins inhibit the reduction of the quinone derivatives of vitamin K to the active hydroquinone forms** (see [Chapter 44](#)). Thus, the administration of vitamin K will bypass the coumarin-induced inhibition and allow the posttranslational modification of carboxylation to occur. Reversal of coumarin inhibition by vitamin K requires 12 to 24 hours, whereas reversal of the anticoagulant effects of heparin by protamine is almost instantaneous. Coumarin reversal is achieved faster by infusing normal coagulation factors.

Heparin and **warfarin** are used in the treatment of thrombotic and thromboembolic conditions, such as deep vein thrombosis and pulmonary embolism, and the prevention of stroke in patients with the heart rhythm abnormality atrial fibrillation. Heparin is administered first, because of its

prompt onset of action, whereas warfarin takes several days to reach full effect. Their effect is not well predictable by dosage, and thus because of the risk of producing hemorrhage, these drugs are closely monitored by use of appropriate tests of coagulation (see below).

New oral inhibitors of thrombin (eg, dabigatran) or of factor Xa (eg, rivaroxaban, apixaban, and others) are also used in the prevention and treatment of thrombotic conditions. These drugs are advantageous because their effect is predictable based on the dose, and some do not require routine monitoring by laboratory tests. Specific reversal agents, such as antibodies or decoy molecules, are in various stages of development. Agents that target the “intrinsic” factors are being evaluated as antithrombotics.

There Are Several Hereditary Bleeding Disorders, Including Hemophilia A

Inherited deficiencies of the clotting system that result in bleeding are found in humans. The most common is deficiency of factor VIII, causing **hemophilia A**, an X chromosome-linked disease. **Hemophilia B**, also **X chromosome-linked**, is due to a deficiency of factor IX and has recently been identified as the form of hemophilia that played a major role in the history of the royal families of Europe. The clinical features of hemophilia A and B are almost identical, but these two diseases can be readily distinguished on the basis of specific assays for the two factors.

The **gene for human factor VIII** measures 186 kb in length, and contains 26 exons that encode a protein of 2351 amino acids. A variety of mutations in the factor VIII and IX genes have been detected leading to diminished activities of the factor VIII and IX proteins; these include partial gene deletions and point and missense mutations. **Prenatal diagnosis** by DNA analysis after chorionic villus sampling is now possible (see [Chapter 39](#)).

Treatment for patients with hemophilia A consisted initially, in the 1960s, of administration of cryoprecipitate (enriched in factor VIII) prepared from individual donors; in the 1970s, lyophilized factor VIII or factor IX concentrates, prepared from very large plasma pools, became available for treatment of hemophilia A and B patients, respectively. In the 1990s, factors VIII and IX prepared by recombinant DNA technology (see [Chapter 39](#)) were introduced. Such preparations are free of contaminating viruses (eg, hepatitis A, B, C, or HIV-1) found in human plasma, but are expensive; their use will increase as the cost of production decreases.

Longer-acting recombinant factors with extended half-lives in the circulation are now in use, and hemophilia is a target of gene therapy approaches.

The most common hereditary bleeding disorder is **von Willebrand disease**, with a prevalence of up to 1% of the population. It results from a deficiency or defect in **von Willebrand factor**, a large multimeric glycoprotein that is secreted by endothelial cells and platelets into the plasma, where it stabilizes factor VIII. von Willebrand factor also promotes platelet adhesion at sites of vessel wall injury and platelet aggregation under conditions of high shear (see above).

Fibrin Clots Are Dissolved by Plasmin

As stated above, the coagulation system is normally in a state of dynamic equilibrium in which fibrin clots are constantly being laid down and dissolved. This latter process is termed **fibrinolysis**. **Plasmin**, the serine protease mainly responsible for degrading fibrin and fibrinogen, circulates in the form of its inactive zymogen, **plasminogen** (90 kDa), and any small amounts of plasmin that are formed in the fluid phase under physiologic conditions are rapidly inactivated by the fast-acting plasmin inhibitor, α_2 -antiplasmin. Plasminogen binds to fibrin and thus becomes incorporated in clots as they are produced; since plasmin that is formed when bound to fibrin is protected from α_2 -antiplasmin, it remains active. **Activators of plasminogen** of various types are found in most body tissues, and all cleave the same Arg-Val bond in plasminogen to produce the disulfide bridge-linked two-chain serine protease, plasmin (**Figure 55–7**). The **specificity of plasmin for fibrin** is another mechanism to regulate fibrinolysis. Via one of its kringle domains, plasmin(ogen) specifically binds lysine residues on fibrin and so is increasingly incorporated into the fibrin mesh as it cleaves it. (Kringles [Figure 55–3] are common protein motifs of about 100 amino acid residues in length; they have a characteristic covalent structure defined by a pattern of three disulfide bonds.) Thus, the carboxypeptidase **activated thrombin activatable fibrinolysis inhibitor (TAFIa)** (**Figure 55–7**), which removes terminal lysines from fibrin, is able to inhibit fibrinolysis. Thrombin activates TAFI to TAFIa, thereby inhibiting fibrinolysis during clot formation.

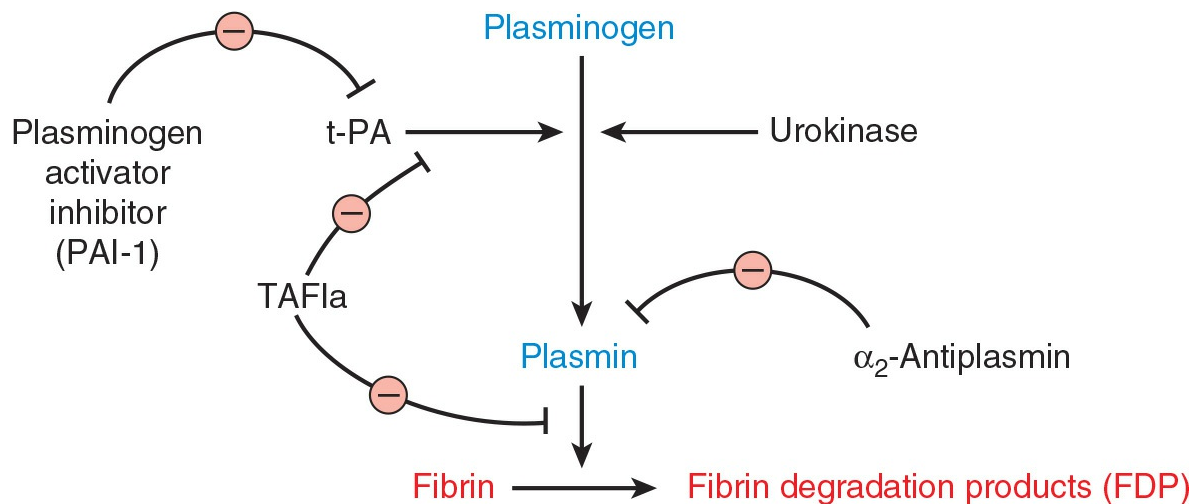

FIGURE 55–7 Initiation of fibrinolysis by the activation of plasminogen to plasmin. Scheme of sites and modes of action of tissue plasminogen activator (t-PA), urokinase, plasminogen activator inhibitor, α_2 -antiplasmin, and thrombin-activatable fibrinolysis inhibitor (TAFIa).

Tissue plasminogen activator (t-PA) (Figures 55–3 and 55–7) is a serine protease that is released into the circulation from vascular endothelium under conditions of injury or stress and is catalytically inactive unless bound to fibrin. Upon binding to fibrin, t-PA cleaves plasminogen within the clot to generate plasmin, which in turn digests the fibrin to form soluble degradation products and thus dissolves the clot. Neither plasmin nor the plasminogen activator can remain bound to these degradation products, and so they are released into the fluid phase where they are inactivated by their natural inhibitors. Prourokinase is the precursor of a second activator of plasminogen, **urokinase**. Originally isolated from urine, it is now known that urokinase is synthesized by various cell types including monocytes and macrophages, fibroblasts, and epithelial cells. The main action of urokinase appears to be the degradation of extracellular matrix. Figure 55–7 indicates the sites of action of five proteins that influence the formation and action of plasmin.

Recombinant t-PA & Streptokinase Are Used as Clot Busters

t-PA, marketed as **alteplase**, is produced by recombinant DNA methods. It is used therapeutically as a fibrinolytic agent, as is **streptokinase**, an enzyme secreted by a number of streptococcal bacterial strains. However, the latter is less selective than t-PA, activating plasminogen in the fluid

phase (where it can degrade circulating fibrinogen) as well as plasminogen that is bound to a fibrin clot. The amount of plasmin produced by therapeutic doses of streptokinase may exceed the capacity of the circulating α_2 -antiplasmin, causing fibrinogen as well as fibrin to be degraded and resulting in the bleeding often encountered during fibrinolytic therapy. Because of its relative **selectivity** for degrading fibrin, recombinant t-PA has been widely used to restore the patency of coronary arteries following thrombosis. If administered early enough, before irreversible damage of heart muscle occurs (about 6 hours after onset of thrombosis), t-PA can significantly reduce the mortality rate from myocardial damage following coronary thrombosis. Streptokinase has also been widely used in the treatment of coronary thrombosis, but has the disadvantage of being antigenic. t-PA has also been used in the treatment of ischemic stroke, peripheral arterial occlusion, deep vein thrombosis, and pulmonary embolism.

There are a number of disorders, including cancer and sepsis, in which the **concentrations of plasminogen activators increase**. In addition, the **antiplasmin activities** contributed by α_1 -antitrypsin and α_2 -antiplasmin may be impaired in diseases such as cirrhosis. Since certain bacterial proteins, such as streptokinase, are capable of activating plasminogen, they may be responsible for the diffuse hemorrhage sometimes observed in patients with disseminated bacterial infections.

Laboratory Tests Measure Platelet Aggregation, Coagulation, & Thrombolysis

A number of **laboratory tests** are available to **measure the phases of hemostasis** described above. The tests include **platelet count, bleeding time/closure time, platelet aggregation, activated partial thromboplastin time (aPTT or PTT), prothrombin time (PT), thrombin time (TT), concentration of fibrinogen, fibrin clot stability, and measurement of fibrin degradation products**. The **platelet count** quantitates the number of platelets. The **skin bleeding time** is an overall test of platelet and vessel wall function, while the **closure time** measured using the platelet function Analyzer PFA-100/200 is an in vitro test of platelet-related hemostasis. **Platelet aggregation** measures responses to specific aggregating agents. aPTT is a measure of the intrinsic pathway and PT of the extrinsic pathway, with aPTT being used to monitor heparin therapy and PT to measure the effectiveness of warfarin. The reader is

referred to a textbook of hematology for a discussion of these tests.

SUMMARY

- Hemostasis and thrombosis are complex processes involving platelets, coagulation factors, and blood vessels.
- Thrombin and other agents cause platelet aggregation, which involves a variety of biochemical and morphologic events. Stimulation of phospholipase C and the polyphosphoinositide pathway is a key event in platelet activation, but other processes are also involved.
- Aspirin is an important antiplatelet drug that acts by inhibiting production of thromboxane A₂.
- Many coagulation factors are zymogens of serine proteases, becoming activated, then inactivated during the overall process.
- Both extrinsic and intrinsic pathways of coagulation exist, the former initiated in vivo by tissue factor. The pathways converge at factor Xa, ultimately resulting in thrombin-catalyzed conversion of fibrinogen to fibrin, which is strengthened by covalent cross-linking, catalyzed by factor XIIIa.
- Genetic disorders that lead to bleeding occur; the principal disorders involve factor VIII (hemophilia A), factor IX (hemophilia B), and von Willebrand factor (von Willebrand disease).
- Antithrombin is an important natural inhibitor of coagulation; genetic deficiency of this protein can result in thrombosis.
- Factors II, VII, IX, and X and proteins C and S require vitamin K–dependent γ -carboxylation of certain glutamate residues to function in coagulation. This carboxylation process can be inhibited by the anticoagulant warfarin.
- Fibrin is dissolved by plasmin. Plasmin exists as an inactive precursor, plasminogen, which can be activated by tissue plasminogen activator (t-PA). t-PA is widely used clinically to treat early thrombosis in the coronary arteries.

REFERENCES

- Hoffman R, Benz EJ Jr, Silberstein LR, et al (editors): *Hematology: Basic Principles and Practice*, 7th ed. Elsevier Saunders, 2017.
- Israels SJ (editor): *Mechanisms in Hematology*, 4th ed. Core Health Sciences Inc, 2011. (This text has many excellent illustrations of basic mechanisms in hematology.)

Kasper DL, Fauci AS, Longo DL, et al: *Harrison's Principles of Internal Medicine*, 19th ed. McGraw-Hill, 2016.

Marder VJ, Aird WC, Bennett JS, et al (editors): *Hemostasis and Thrombosis: Basic Principles and Clinical Practice*, 6th ed. Lippincott Williams & Wilkins, 2013.

Michelson AD (editor): *Platelets*, 3rd ed. Elsevier, 2013.

Cancer: An Overview

Molly Jacob, MD, PhD, Joe Varghese, PhD & P. Anthony Weil, PhD

OBJECTIVES

After studying this chapter, you should be able to:

- Present an overview of carcinogenesis and important biochemical and genetic features of cancer cells.
- Describe important properties of oncogenes and tumor suppressor genes and their role in carcinogenesis.
- Describe the important characteristics of cancer cells that distinguish them from normal cells.
- Briefly describe the concepts of genomic instability, aneuploidy, and angiogenesis in tumor formation and growth.
- Discuss the relevance of tumor markers.
- Outline how understanding of the biology of cancer has led to the development of various new therapies.

BIOMEDICAL IMPORTANCE

Cancers constitute the **second most common cause of death**, after

cardiovascular disease, in many countries. Approximately 9 million people around the world die from cancer each year, and this figure is projected to increase. Humans of all ages develop cancer, and a wide variety of organs are affected. Worldwide, the main types of cancer accounting for mortality are those involving the lung, stomach, colon, rectum, liver, and breast. Other types of cancers that lead to death include cervical, esophageal, and prostate cancers. Skin cancers are also very common, but apart from melanomas, are generally not as aggressive as those mentioned above. The **incidence** of many cancers **increases with age**. Hence, as people live longer, many more will develop the disease. Hereditary factors play a role in some types of tumors. Apart from great individual suffering caused by the disease, the economic burden to society is immense.

SOME GENERAL COMMENTS ON NEOPLASMS

A neoplasm refers to any abnormal new growth of tissue. It may be benign or malignant in nature. The term “cancer” is usually associated with malignant tumors. Tumors can arise in any organ in the body and result in different clinical features, depending on the location of the growth.

Cancer cells are characterized by certain **key properties**: they (1) **proliferate rapidly**; (2) **display diminished growth control**; (3) **display increased genomic mutations** at the level of the nucleotide, small and large insertions and deletions (indels), and gross chromosomal rearrangements, duplications and loss; (4) display **loss of contact inhibition** in culture in vitro; (5) **invade local tissues** and spread, or **metastasize**, to other parts of the body; (6) are **self-sufficient in growth signals** and are **insensitive to antigrowth signals**; (7) stimulate local **angiogenesis**; and (8) are often able to **evade apoptosis**. These properties are characteristic of cells of **malignant tumors**. It is metastasis that is generally responsible for the deaths of patients who have cancer. By contrast, cells of **benign tumors** also show diminished control of growth, but do not invade local tissue or spread to other parts of the body. These points are summarized in **Figure 56–1** and amplified on in **Figure 56–2**.

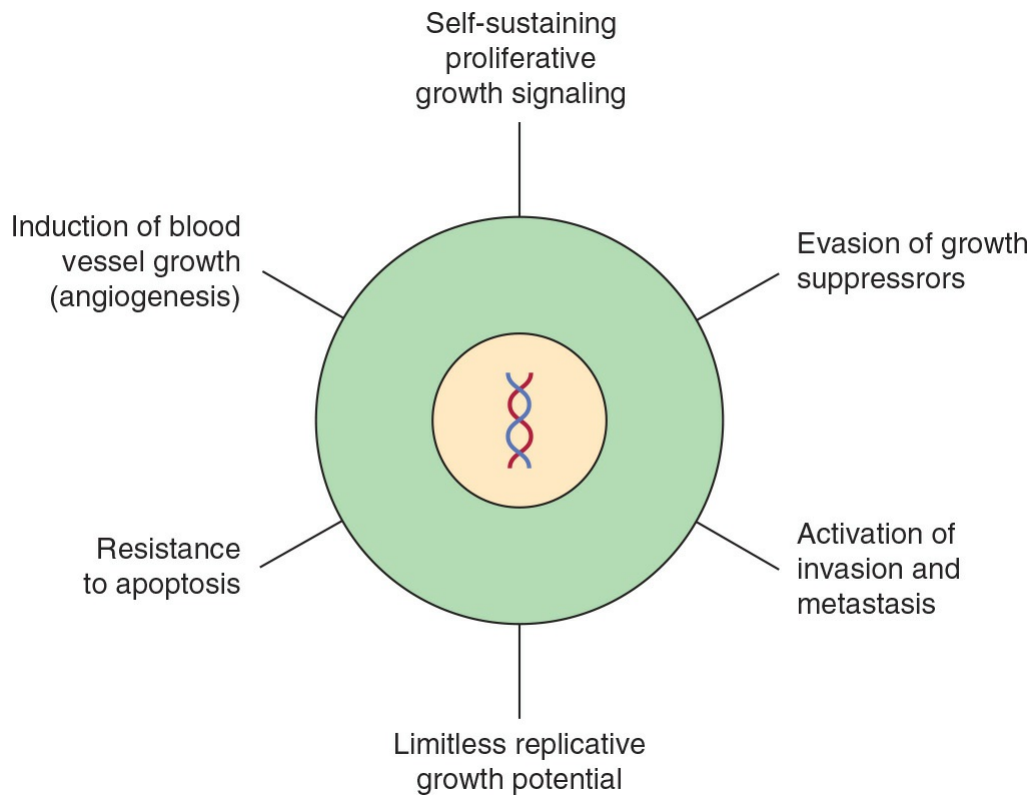

FIGURE 56–1 Six major biologic features of cancer cells. Other key properties of cancer cells are shown in [Figure 56–2](#). (After Hanahan D, Weinberg RA. The Hallmarks of Cancer: The next generation. *Cell* 2011;144:646-674.)

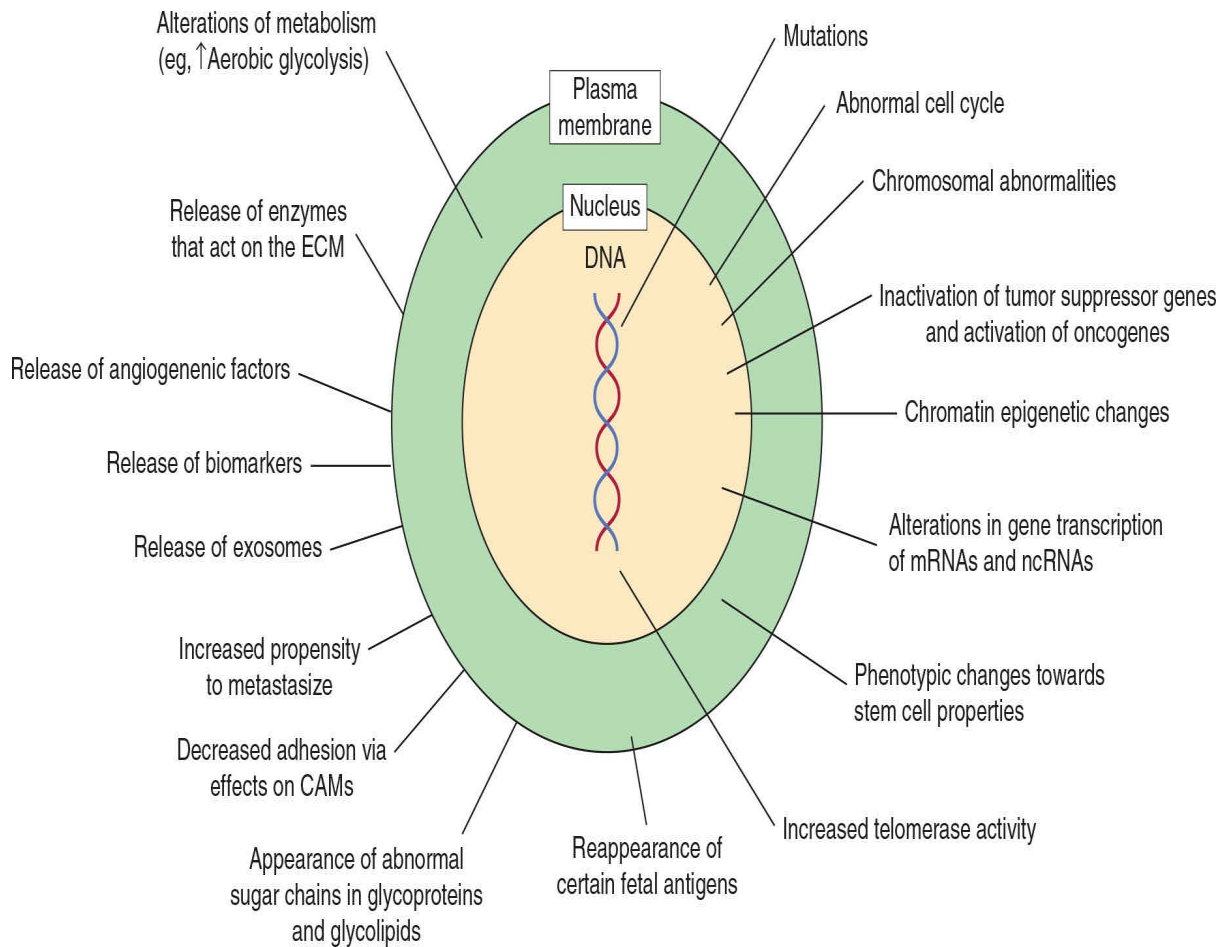

FIGURE 56–2 Some biochemical and genetic changes that occur in

human cancer cells. Many changes, in addition to those indicated in Figure 56–1, can be observed in cancer cells; only some of these are shown here. The roles of mutations in activating oncogenes and inactivating tumor suppressor genes are discussed in the text.

Abnormalities of cell cycle progression and of chromosome and chromatin structure, including aneuploidy, are common. Alterations of expression of specific mRNAs and regulatory ncRNAs have been reported, and the relationship of stem cells to cancer cells is a very active area of research. Telomerase activity is often detectable in cancer cells. Tumors sometimes synthesize certain fetal antigens, which may be measurable in the blood. Changes in plasma membrane constituents (eg, alteration of the sugar chains of various glycoproteins—some of which are cell adhesion molecules—and glycolipids) have been detected in many studies, and may be of importance in relation to decreased cell adhesion and metastasis. Various molecules are released from cancer cells, in either soluble or membrane-bound vesicular forms (exosomes), and can be detected in the blood or extracellular fluid; these include metabolites, lipids, carbohydrates, proteins, and nucleic acids. Angiogenic factors and various

proteases are also released by some tumors. Many changes in metabolism have been observed; for example, cancer cells often exhibit a high rate of aerobic glycolysis. (CAM, cell adhesion molecule; ECM, extracellular matrix.)

Central issues in oncology (the study of cancer) include elucidation of biochemical and genetic mechanisms that underlie the uncontrolled growth of cancer cells and their ability to invade and metastasize, and development of successful treatments that will destroy cancer cells, while causing minimal damage to normal cells. Considerable progress has been made in understanding the basic nature of cancer cells, and it is now generally accepted that though mutations in key genes contribute significantly to malignancies, particularly at the initiation phase of oncogenesis, other factors are also implicated in the development of malignant phenotypes. Organismal immunologic status and tissue microenvironment are two such factors. Recent work has shown that the microenvironment of host and tumor cells, and the interactions between them contribute to the pathogenesis of malignancies. However, many aspects of the behavior of cancer cells, in particular their ability to metastasize, have yet to be fully explained. In addition, despite improvements in treatment of certain types of cancers, therapies are still often unsuccessful. This chapter aims to introduce the reader to key concepts of cancer biology. A **glossary** at the end of this chapter defines many of the terms used herein.

FUNDAMENTAL FEATURES OF CARCINOGENESIS

Non-lethal genetic damage is thought to be the initiating event in carcinogenesis. There are several broad classes of genes, which when mutated cause gain- or loss-of-function or misregulation, and can thus result in the development of a tumor. These are **proto-oncogenes**, **tumor suppressor** genes, **DNA synthesis** and **repair** genes, genes regulating **apoptosis**, or genes causing **evasion of immune surveillance**.

Cancer is of **clonal origin**, with a single abnormal cell (often with many genetic alterations) multiplying to become a mass of cells forming a tumor. As mentioned earlier, the **tissue microenvironment** significantly affects tumor formation. The exact nature of these influences may vary with cell types involved, cell–cell interactions, and the presence of factors such as paracrine signals, local hypoxia, and proinflammatory responses.

Carcinogenesis is, thus, a **multistep process** that ultimately transforms normal cells into malignant cells. Tumors often take from a few to tens of years to develop to macroscopic levels.

CAUSES OF GENETIC DAMAGE

Genetic damage causing cancer can be due to **acquired**, or **inherited mutations**. Acquired mutations occur either by errors in DNA replication or DNA repair, and are termed **replication mutations (R)**, or by exposure to environmental carcinogens, and are termed **environmental mutations (E)** (radiation, chemicals and viruses—see below). The third major class of oncogenic mutation are termed **hereditary mutations (H)**; inherited mutations are derived from one or both parents. Such hereditary abnormalities result in a number of **familial conditions** that predispose to hereditary cancer. These mutations are found in specific genes (eg, tumor suppressor genes; DNA repair genes, cell cycle control genes, etc) present in the germ cells, and are discussed later in this chapter. Mutations of the R, E, and H variety collectively cause the majority of human cancers, though the exact percentage of a particular type of cancer caused by these three types of mutations varies, and indeed is being actively debated in the field of medical oncology.

Spontaneous mutations, some of which may predispose to cancer, occur at a frequency of approximately 10^{-7} to 10^{-6} per cell per generation. This rate is greater in tissues undergoing a high rate of proliferation, a dynamic that can increase the generation of cancer cells from affected parent cells. **Oxidative stress** (see [Chapter 45](#)), generated as a result of enhanced production of **reactive oxygen species (ROS)**, may also be a factor in increasing mutation rates.

RADIATION, CHEMICALS, AND CERTAIN VIRUSES ARE MAJOR KNOWN CAUSES OF CANCER

In general, there are three classes of environmental carcinogens that can induce tumor formation: **radiation**, **chemicals**, and certain **oncogenic viruses** ([Figure 56–3](#)). The first two carcinogens cause mutations in DNA, while viruses generally act by introducing novel genes into normal cells.

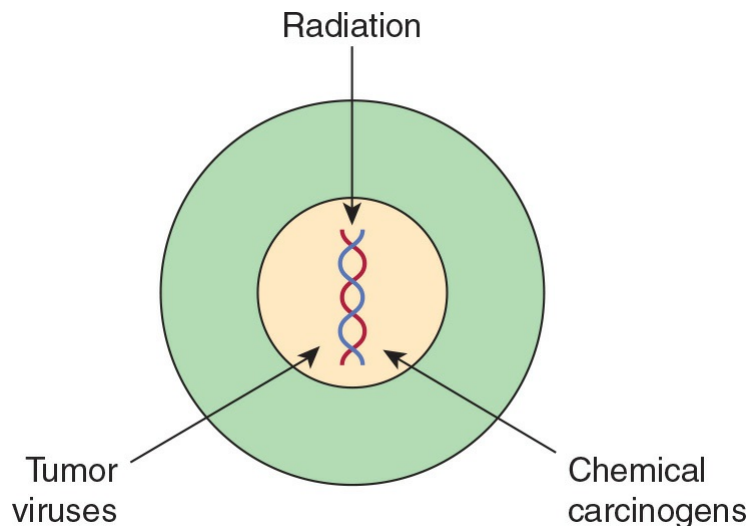

FIGURE 56–3 Radiation, chemical carcinogens, and certain viruses can cause cancer by damaging chromosomal DNA.

We shall only briefly describe how radiation, chemicals, and oncogenic viruses cause cancer.

Radiation Can Be Carcinogenic

Ultraviolet rays (UV), x-rays, and γ -rays are mutagenic and carcinogenic. Extensive studies have shown that these agents damage DNA in a number of ways ([Table 56–1](#); see also [Table 35–8](#), and [Figure 35–22](#)). Mutations in DNA, if not corrected, are thought to underlie the carcinogenic effect of **radiation**, although the exact pathways are still under investigation. Additionally, x-rays and γ -rays can induce formation of **reactive oxygen species (ROS)**, which as noted above are also mutagenic and probably contribute to the carcinogenic effects of radiation.

TABLE 56–1 Some Types of DNA Damage Caused by Radiation

- Formation of pyrimidine dimers
- Formation of apurinic or apyrimidinic sites by elimination of corresponding bases
- Formation of single- or double-strand breaks or cross-linking of DNA strands

Exposure to UV radiation is common due to exposure to sunlight, which is its main source. Ample evidence shows that UV radiation is linked to cancers of the skin. The risk of developing a skin cancer due to ultraviolet radiation increases with increased frequency and intensity of

exposure, and decreases with increasing melanin content of skin.

As detailed in [Chapter 35](#), DNA damage produced by environmental agents is usually removed by DNA repair mechanisms. Not surprisingly then, given the mutagenic nature of DNA damage, individuals who have an inherited inability to repair DNA have increased risk of developing a malignancy (see [Table 35–9](#)).

Many Chemicals Are Carcinogenic

A wide variety of chemical compounds are carcinogenic ([Table 56–2](#)).

TABLE 56–2 Some Chemical Carcinogens

Class	Compound
Polycyclic aromatic hydrocarbons	Benzo[a]pyrene, dimethylbenzanthracene
Aromatic amines	2-Acetylaminofluorene, <i>N</i> -methyl-4-aminoazobenzene (MAB)
Nitrosamines	Dimethylnitrosamine, diethylnitrosamine
Various drugs	Alkylating agents (eg, cyclophosphamide), diethylstilbestrol
Naturally occurring compounds	Aflatoxin B ₁

Most **chemical carcinogens** are thought to **covalently modify DNA** thereby forming a wide range of **nucleotide adducts** (see [Table 35–8](#)). Depending on the extent of damage to DNA and its repair by DNA repair systems (see [Figure 35–22](#)), a variety of mutations in DNA can result from exposure of an animal or human to chemical carcinogens, some of which contribute to the development of cancer.

Some chemicals interact directly with DNA (eg, mechlorethamine and β -propiolactone), but others, termed **procarcinogens**, require conversion by enzyme action to become **ultimate carcinogens**. Most ultimate carcinogens are **electrophiles** (molecules deficient in electrons) and readily attack nucleophilic (electron-rich) groups in DNA. Conversion of chemicals to ultimate carcinogens is principally due to the actions of various species of **cytochrome P450** located in the endoplasmic reticulum (ER) (see [Chapter 49](#)). This fact is used in the Ames assay (see below), in which an aliquot of postmitochondrial supernatant (containing ER) is

added to the assay system as a source of cytochrome P450 enzymes.

Chemical carcinogenesis involves two stages—initiation and promotion. Initiation is the stage where exposure to a chemical cause genomic DNA damage, some of which go unrepaired, and is a necessary initial event for a cell to become cancerous. Promotion is the stage at which an initiated cell begins to grow and proliferate abnormally. The cumulative effect of these two events is a neoplasm.

Chemical carcinogens can be identified by testing for their ability to induce mutations. A simple way to do this is by using the **Ames assay** (**Figure 56–4**). This relatively simple test, which detects mutations in the bacterium *Salmonella typhimurium* caused by chemicals, has proven very valuable for screening purposes. A refinement of the Ames test is to add an aliquot of mammalian ER to the assay, to make it possible to identify procarcinogens. Very few, if any, compounds that have tested negative in the Ames test have been shown to cause tumors in animals. However, animal testing is required to show unambiguously that a chemical is carcinogenic.

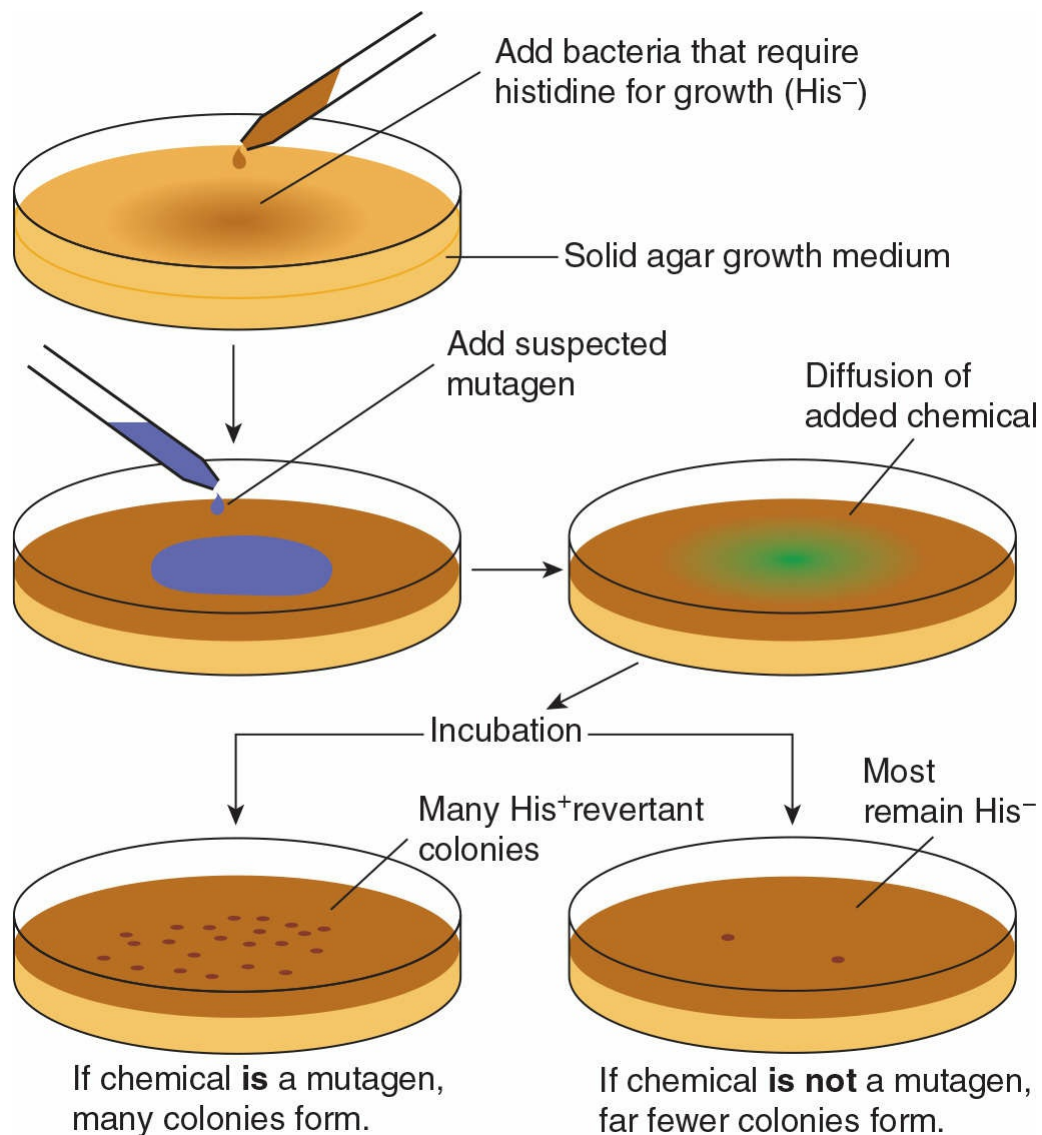

FIGURE 56–4 The Ames assay to screen for mutagens. The chemical tested will increase the frequency of reversion of His⁻ to His⁺ cells if it is a mutagen and, therefore, a potential carcinogen. A control plate (not shown) contains the solvent in which the suspected mutagen is dissolved. (Reproduced, with permission, from Nester EW, et al: *Microbiology: A Human Perspective*, 5th ed. McGraw-Hill, 2007.)

It should be noted that compounds that alter epigenetic factors (such as DNA methylation and/or histone posttranslational modifications; see [Chapters 35, 38](#)) that might predispose to cancer, would not test positive in the Ames test, as they are not mutagenic.

Certain Human Cancers Are Caused By Viruses

The study of **tumor viruses** has contributed significantly to the

understanding of cancer. For example, discovery of both oncogenes and tumor suppressor genes (see below) emerged from studies of oncogenic viruses. Both DNA and RNA viruses have been identified as being able to cause cancers in humans (**Table 56–3**). The details of how each of these viruses causes cancer will not be described here. In general, the genetic material of viruses is incorporated into the genome of the host cell. In the case of RNA viruses, this would occur after reverse transcription of the viral RNA to viral DNA. Such integration of viral DNA (called the provirus) into the host DNA results in various effects such as **deregulation of the cell cycle, inhibition of apoptosis, and abnormalities of cell-signaling pathways** (see **Chapters 35, 42**). All these events are discussed later in this chapter. **DNA viruses** often act by **downregulation** of the expression, and/or function of tumor suppressor genes *P53* and *RB* (see below) and their protein products. RNA viruses often carry oncogenes in their genomes; how oncogenes act to cause malignancy is discussed below.

TABLE 56–3 Some Viruses That Cause or Are Associated With Human Cancers

Virus	Genome	Cancer
Epstein-Barr virus	DNA	Burkitt lymphoma, nasopharyngeal cancer, B-cell lymphoma
Hepatitis B	DNA	Hepatocellular carcinoma
Hepatitis C	RNA	Hepatocellular carcinoma
Human herpesvirus 8 (HHV-8)	DNA	Kaposi sarcoma
Human papilloma viruses (types 16 and 18)	DNA	Cancer of the cervix
Human T-cell leukemia virus type 1	RNA	Adult T-cell leukemia

ONCOGENES AND TUMOR SUPPRESSOR GENES PLAY KEY ROLES IN CAUSING CANCER

Over the past several decades, major advances have been made in

understanding how cancer cells develop and grow. Two key findings were the discoveries of **oncogenes** and **tumor suppressor genes**. These discoveries pointed to specific molecular mechanisms through which cell growth and division could be dysregulated, resulting in abnormal growth.

Oncogenes Are Derived From Cellular Genes Termed Proto-Oncogenes, and Encode a Wide Variety of Proteins That Stimulate Cell Growth

An **oncogene** can be defined as an altered gene, the product of which acts in a **dominant** manner to accelerate cell growth or cell division. Oncogenes are generated by “activation” of normal cellular **proto-oncogenes**, which encode growth-stimulating proteins. Such activation can be effected through any of several different mechanisms (**Table 56–4**).

TABLE 56–4 Mechanisms by Which Oncogenes Are Activated

Mechanism	Explanation
Mutation	A classic example is a point mutation of the <i>RAS</i> oncogene. This results in the gene product, a small G-protein (<i>RAS</i>), in which the intrinsic GTPase activity of the protein is lost. Consequently, cells are subjected to constitutively active signaling via stimulation of adenylyl cyclase and the mitogen-activated protein (<i>MAP</i>) kinase pathway.
Promoter insertion	Insertion of a viral promoter sequence near an oncogene activates it.
Enhancer insertion	Insertion of a viral enhancer sequence near an oncogene activates it.
Chromosomal translocation	A piece of one chromosome is split off and is joined to another, resulting in activation of an oncogene at the site where insertion occurs. Classic examples of such translocations include those seen in Burkitt lymphoma (see Figure 56–5) and in the Philadelphia chromosome in chronic myelocytic leukemia (see the Glossary).
Gene amplification ^a	Abnormal multiplication of a gene occurs, resulting in many copies. This can occur with oncogenes and genes involved in drug resistance.

[Table 56–4](#) lists an example of a point mutation occurring in the *RAS* oncogene. *RAS* encodes a small GTPase. Loss of the GTPase activity of this G-protein results in chronic stimulation of the activity of adenylyl cyclase and the MAP kinase pathway, leading to cell proliferation (recall that G-proteins are active when complexed with GTP and inactive when the bound GTP is hydrolyzed to GDP by GTPase; see [Chapter 42](#)).

Another way an oncogene can be activated is via insertion of an enhancer and/or a strong promoter upstream of a protein-coding gene, resulting in increased transcription (and hence protein expression) of the cognate gene. [Figure 56–5A](#) illustrates how integration of a retroviral provirus (ie, the reverse transcriptase-generated dsDNA copy of the RNA genome of a tumor virus such as **Rous sarcoma virus, RSV**) can act as an enhancer/promoter to activate *MYC*, a neighboring host gene. Overproduction of the oncogenic transcription factor MYC activates the transcription of cell cycle–regulatory genes and, hence, stimulates unregulated cell proliferation.

A

(1)

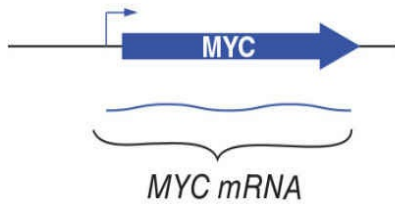

(2)

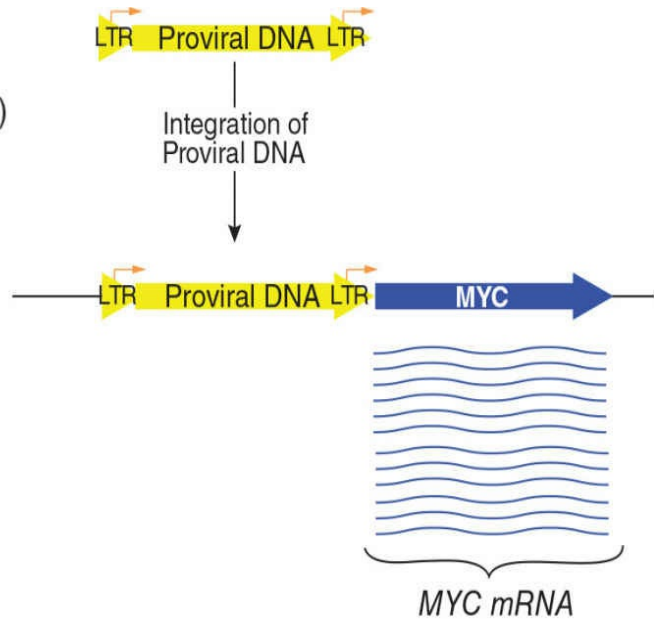

B

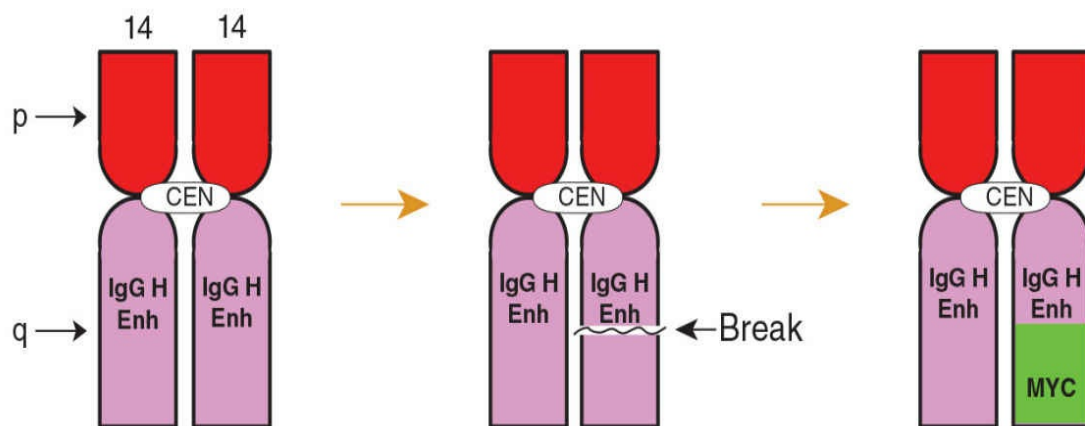
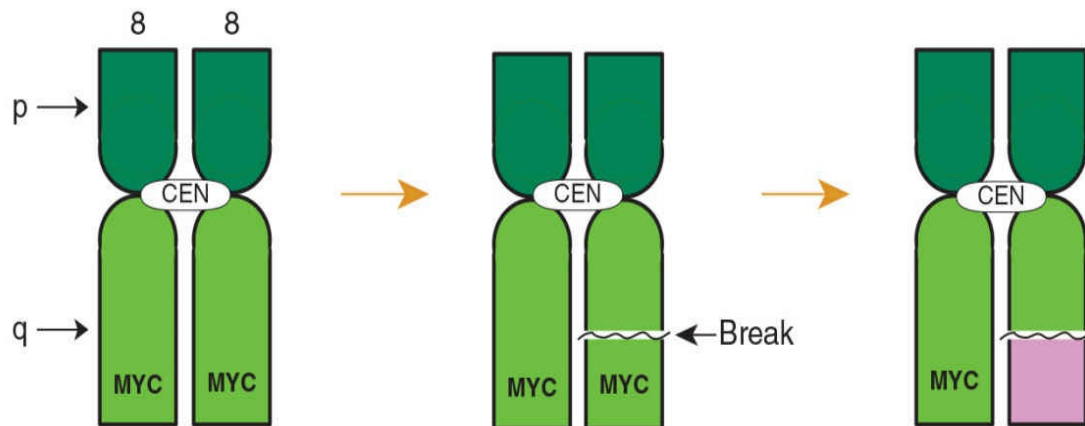

TRANSLOCATION
t(8;14)(q24;q32)

FIGURE 56–5 (A) Schematic representation of how promoter insertion may activate a proto-oncogene. (1) Normal chicken chromosome showing a nearly inactive *MYC* gene. (2) An avian leukemia virus has integrated in the chromosome in its proviral form (a DNA copy of its RNA genome) adjacent to the *MYC* gene with the RSV right-hand long terminal repeat (LTR) sequence element, which contains both a strong enhancer and promoter (see [Chapter 36](#)) now resides just upstream of the *MYC* gene and therefore activates *MYC*, resulting in vigorous transcription of the *MYC* mRNA. For simplicity, only one strand of DNA is depicted and other details have been omitted. **(B) Schematic representation of the reciprocal translocation involved in Burkitt lymphoma.** The chromosomes involved are 8 and 14. Letters p, q refer to the short and long arms of the chromosomes, while the white oval labeled CEN, is the centeromere. Only a portion of each chromosome is shown. A segment from the end of the q arm of chromosome 8 breaks off and translocates to chromosome 14. The reverse process moves a small segment from the q arm of chromosome 14 to chromosome 8; these translocations involve regions q24 (chromosome 8) and q32 (chromosome 14). The *MYC* gene is contained in the small piece of chromosome 8 that was transferred to chromosome 14. Thus, *MYC* is placed adjacent to the genes transcribing the heavy chains of immunoglobulin molecules, and *MYC* gene transcription is activated by the potent IgG H gene enhancer. Many other translocations have been identified, with perhaps the best known being that involved in formation of the Philadelphia chromosome (see the Glossary). (Revised and redrawn from Dalla-Favera et al. Human c-myc *onc* gene is located on the region of chromosome 8 that is translocated in Burkitt lymphoma cells. *Proc Nat Acad Sci USA* 1982;79:7824-7827, for more detail.)

Chromosomal translocations are found quite frequently in cancer cells; literally hundreds of different examples have been documented. The translocation found in cases of Burkitt lymphoma is illustrated in [Figure 56–5B](#). The overall effect of this translocation is also to activate *MYC* gene expression, resulting in cell proliferation.

Yet another mechanism of oncogene activation is via **gene amplification** (see [Chapter 38](#)), a process that occurs quite commonly in various cancers. In this case, multiple copies of an oncogene are formed, which results in increased production of a growth-promoting protein.

Activated oncogenes promote cancer through a variety of mechanisms as depicted in [Figure 56–2](#) and summarized in [Figure 56–6](#). The protein

products of activated oncogenes affect cell signaling pathways, where they may act as a growth factor, a receptor for a growth factor, a G-protein, or as a downstream signaling molecule. Other oncoproteins act to alter transcription of genes crucial for oncogenesis or to deregulate the cell cycle. Still other oncoproteins affect cell–cell interactions, or the process of apoptosis. Collectively, these mechanisms explain many of the major features of cancer cells shown in [Figure 56–1](#), such as their limitless replicative potential, their constitutively activated signaling pathways, their ability to invade and spread, and their evasion of apoptosis.

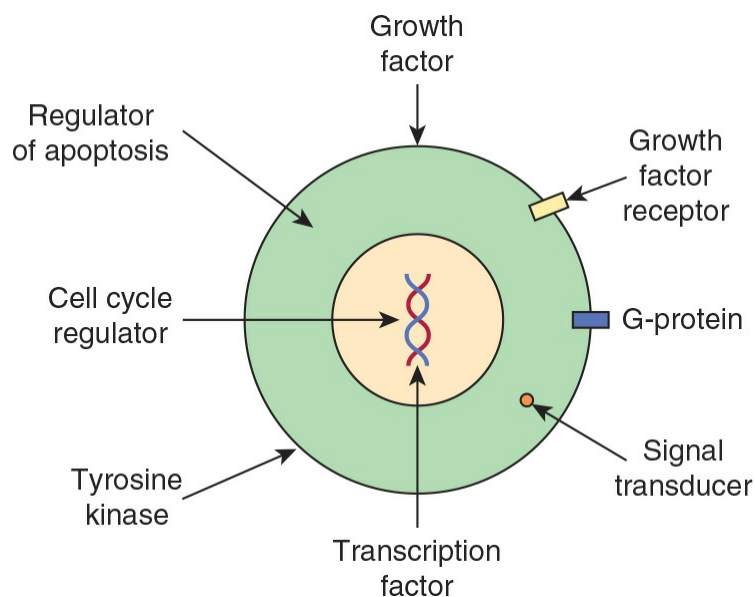

FIGURE 56–6 Examples of ways by which oncoproteins work. Shown are examples of various proteins encoded by oncogenes (oncoproteins). The proteins are listed below with the corresponding oncogene given in parentheses along with its OMIM number. A growth factor, fibroblast growth factor 3 (*INT2*, 164950); a growth factor receptor, epidermal growth factor receptor [EGFR] (*HER1*, 131550); a G-protein (*H-RAS-1*, 190020); a signal transducer (*BRAF*, 164757); a transcription factor (*MYC*, 190080); a tyrosine kinase involved in cell–cell adhesion (*SRC*, 190090); a cell cycle regulator (*PRAD*, 168461); a regulator of apoptosis (*BCL2*, 151430).

Certain **tumor viruses** (eg, retroviruses, papovaviruses) **contain oncogenes**. It was the study of such tumor viruses (eg, the retrovirus RSV) that first revealed the presence of oncogenes. Further study showed that many retroviral oncogenes were derived from normal cellular genes, the so-called proto-oncogenes, which the tumor viruses had picked up during their passage through host cells.

Tumor Suppressor Genes Act to Inhibit Cell Growth and Division

A **tumor suppressor gene** produces a protein that normally suppresses cell growth or cell division. When such a gene is altered by mutation, the inhibitory effect of its product is lost or diminished. This loss-of-function of a tumor suppressor gene leads to increased cell growth or division. As first suggested by AG Knudson in 1971, based on studies of the inheritance of retinoblastomas, both copies of a tumor suppressor gene must be affected for it to lose its inhibitory effects on growth (ie, a mutated loss-of-function allele, rb^- , is recessive to a wild-type RB copy of the gene).

A useful distinction has been made between **gatekeeper** and **caretaker** functions of tumor suppressor genes. Gatekeeper genes (products) control cell proliferation, and include mainly genes that act to regulate the cell cycle and apoptosis. By contrast, caretaker gene products are concerned with preserving the integrity of the genome, and include genes whose protein products are involved in recognizing and correcting DNA damage and in maintaining chromosomal integrity during cell division.

Many oncogenes and tumor suppressor genes have now been identified. Only a few are mentioned here. The important differences between oncogenes and tumor suppressor genes are listed in **Table 56–5**. **Table 56–6** lists some properties of two of the most intensively studied oncogenes (MYC and RAS), and two of the most highly studied tumor suppressor genes ($P53$ and RB).

TABLE 56–5 Differences Between Oncogenes and Tumor Suppressor Genes

Oncogenes	Tumor Suppressor Genes
Mutation in one of the two alleles is sufficient to produce oncogenic effects.	Mutations in both alleles are required to produce oncogenic effects.
Oncogenic effect is due to gain-of-function of a protein that stimulates cell growth and proliferation	Oncogenic effect is due to loss-of-function of a protein that inhibits cell growth and proliferation.
Mutations in oncogenes arise in somatic cells, and hence are not inherited.	Mutations in tumor suppressor genes may be present in somatic or germ cells (and hence, may be inherited)
Usually do not show tissue preference with respect to the type of cancers in which they are found	Often demonstrate strong tissue preference with respect to the type of cancers in which they are found (eg, mutations in the <i>RB</i> gene result in retinoblastoma)

TABLE 56–6 Properties of Some Important Oncogenes and Tumor Suppressor Genes

Name	Properties
<i>MYC</i>	An oncogene (OMIM 190080) that encodes a transcription factor that can alter transcription of many key cellular regulatory genes. <i>MYC</i> is involved in stimulation of cell growth, cell cycle progression, and DNA replication. It is mutated in a variety of tumors.
<i>P53</i>	A tumor suppressor gene (OMIM 191170) that is activated in response to various stimuli that produce DNA damage. Activation of p53 induces cell cycle arrest, apoptosis, senescence, and DNA repair. It is also involved in some aspects of regulation of cellular metabolism. It has, therefore, been named “the guardian of the genome.” p53 is mutated in about 50% of human tumors.
<i>RAS</i>	A family of oncogenes encoding small G-proteins, specifically GTPases that were initially identified as the transforming genes present in certain murine sarcoma viruses. Important members of the family are <i>K-RAS</i> (Kirsten), <i>H-RAS</i> (Harvey) (OMIM 190020), and <i>N-RAS</i> (neuroblastoma). Persistent activation of these genes due to mutations contributes to the development of a variety of cancers.
<i>RB</i>	A tumor suppressor gene (OMIM 180200) encoding the Rb protein. Rb, a transcriptional repressor, regulates the cell cycle by binding to the activating transcription factor E2F. Rb represses the transcription of various genes involved in the transition of the G ₁ phase of the cell cycle to the S phase. Mutation of the <i>RB</i> gene results in retinoblastoma, but it is also involved in the genesis of certain other tumors (see Chapter 35).

Studies of the Development of Colorectal Cancers Have Illuminated the Involvement of Specific Oncogenes and Tumor Suppressor Genes

Many types of tumors have been analyzed for genetic changes. One of the earliest studied and most informative areas in this respect has been analysis of the **development of colorectal cancer** by Vogelstein and colleagues. Their work, and that of others, has shown the involvement of various oncogenes and tumor suppressor genes in human cancer. These

workers analyzed the sequence and expression of various oncogenes, tumor suppressor genes, and certain other relevant genes in samples of **normal colonic epithelium**, of **dysplastic epithelium** (a preneoplastic condition, characterized by abnormal development of epithelium), various stages of **adenomatous polyps**, and **adenocarcinomas**. Some of the key findings are summarized in **Figure 56–7**. It can be seen that certain genes are mutated at relatively specific stages of the sequence of events shown. The functions of the various genes identified are listed in **Table 56–7**. The overall sequence of changes can vary from that shown and other genes may also be involved. Similar studies have been performed on a number of other human tumors, revealing different patterns of activation of oncogenes, and mutations of tumor suppressor genes. Further mutations in these and other genes are involved in **tumor progression**, a phenomenon whereby clones of tumor cells get selected for fast growth rate and ability to metastasize. Thus, a relatively large tumor may contain a variety of cells with different genotypes, making successful treatment more difficult.

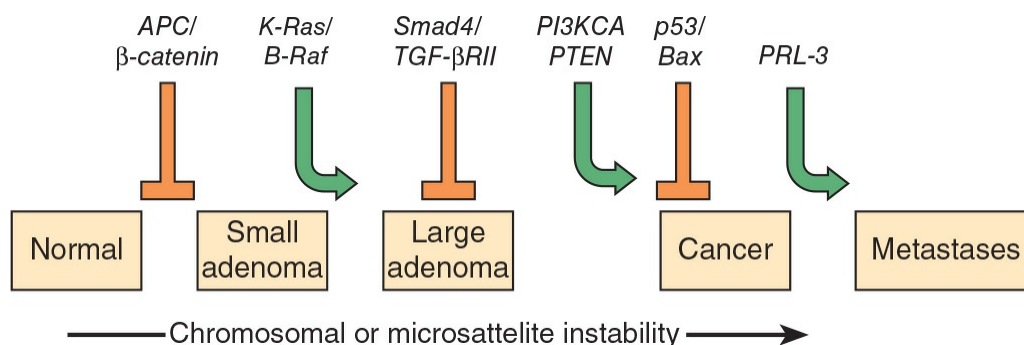

FIGURE 56–7 Multistep genetic changes associated with the development of colorectal cancers. Mutations in the *APC* gene initiate the formation of adenomas. One sequence of mutations in an oncogene and in various tumor suppressor genes that can result in further progression to large adenomas and cancer is indicated. Patients with familial adenomatous polyposis (OMIM 175100) inherit mutations in the *APC* gene and develop numerous dysplastic aberrant crypt foci (ACF), some of which progress as they acquire the other mutations indicated in the figure. The tumors from patients with hereditary nonpolyposis colon cancer (OMIM 120435) go through a similar, though not identical, series of mutations; mutations in the DNA mismatch repair system (see [Chapter 35](#)) speed up this process. K-RAS, BRAF, and PI3KCA are oncogenes; the other genes listed are tumor suppressor genes. The sequence of events shown here is not invariable in the development of all colorectal cancers. A variety of other genetic alterations have been described in a small

fraction of advanced colorectal cancers. These may be responsible for the heterogeneity of biologic and clinical properties observed among different cases. Instability of chromosomes and microsatellites (see [Chapter 35](#)) occurs in many tumors, and likely involves mutations in a considerable number of genes. (Reproduced, with permission, from Bunz F, Kinzler KW, Vogelstein B: Colorectal tumors, Fig. 48-2, *The Online Metabolic & Molecular Bases of Inherited Disease*, www.ommbid.com)

TABLE 56–7 Some Genes Associated With Colorectal Carcinogenesis

Gene ^a	Action of Encoded Protein
APC (OMIM 611731)	Antagonizes WNT ^b signaling; if mutated, WNT signaling is enhanced, stimulating cell growth.
β-CATENIN (OMIM 116806)	Encodes β-catenin, a protein present in adherens junctions, which are important for the integrity of epithelial tissues. It is an integral part of the WNT signaling pathway.
K-RAS (OMIM 601599)	Involved in tyrosine kinase signaling, especially in the mitogen-activated protein (MAP) kinase pathway.
BRAF (OMIM 164757)	A serine/threonine kinase that acts in concert with Ras to activate the MAP kinase pathway.
SMAD4 (OMIM 600993)	Involved in intracellular signaling by transforming growth factor β (TGF-β ^c).
TGF-βRII	Acts as a receptor for TGF-β.
PI3KCA (OMIM 171834)	Acts as a catalytic subunit of phosphatidylinositol 3-kinase (PI3K).
PTEN (OMIM 601728)	A protein tyrosine phosphatase which acts as an important inhibitor of signaling via the PI3K-Akt pathway.
P53 (OMIM 191170)	The product, p53, is induced in response to DNA damage and is also a transcription factor for many genes involved in cell division (see Chapter 35 , Table 56–10).
BAX (OMIM 600040)	Acts to induce cell death (activator of apoptosis).
PRL3 (OMIM 606449)	A protein tyrosine phosphatase involved in cell cycle regulation.

Several conclusions can be drawn from these results and those from other similar studies. First, **cancer is truly a genetic disease**, but in a somewhat different sense from the normal meaning of the phrase, insofar as many of the gene alterations are due to somatic mutations. Second, **carcinogenesis is a multistep process**. It is estimated that in most cases a minimum of five to six genes must be mutated for cancer to occur. Third, additional subsequent mutations are thought to confer selective advantages on clones of cells, some of which acquire the **ability to metastasize** (see below). Finally, many of the genes implicated in colorectal carcinogenesis and other types of cancers are involved in cell signaling events, showing again the central role that **alterations in signaling** play in the development of cancer.

GROWTH FACTORS AND ABNORMALITIES OF THEIR RECEPTORS AND SIGNALING PATHWAYS PLAY MAJOR ROLES IN CANCER DEVELOPMENT

There Are Many Growth Factors

A large variety of polypeptide growth factors that affect human tissues and cells have been identified. Some are listed in [Table 56–8](#). Here, we focus mostly on their relationship with cancer.

TABLE 56–8 Some Polypeptide Growth Factors

Growth Factor	Function
Epidermal growth factor (EGF)	Stimulates growth of many epidermal and epithelial cells
Erythropoietin (EPO)	Regulates development of early erythropoietic cells
Fibroblast growth factors (FGFs)	Promote proliferation of many different cells
Interleukins	Interleukins exert a variety of effects on cells of the immune system
Nerve growth factor (NGF)	Trophic effect on certain neurons
Platelet-derived growth factor (PDGF)	Stimulates growth of mesenchymal and glial cells
Transforming growth factor α (TGF- α)	Similar to EGF
Transforming growth factor β (TGF- β)	Exerts both stimulatory and inhibitory effects on certain cells

Growth factors can act in an **endocrine**, **paracrine**, or **autocrine** manner (see [Chapter 41](#)) and affect a wide variety of cells to produce a **mitogenic response** (see [Chapter 42](#)). As described earlier (see [Chapter 53](#)), growth factors play important roles in the differentiation of hematopoietic cells.

Growth inhibitory factors also exist. For example, transforming growth factor β (TGF- β) exerts inhibitory effects on the growth of certain

cells. Thus, chronic exposure to either increased amounts of a growth factor, or to decreased amounts of a growth inhibitory factor, can alter the balance of cellular growth.

Growth Factors Work via Specific Receptors and Transmembrane Signaling to Affect the Activities of Specific Genes

Growth factors produce their effects by interacting with **specific receptors** on cell surfaces, initiating **various signaling events** (see [Chapter 42](#)). Genes encoding receptors for growth factors have been identified and characterized. These receptors generally have short membrane-spanning segments and external and cytoplasmic domains (see [Chapters 40, 42](#)), and a number (eg, those for epidermal growth factor [EGF], insulin and platelet-derived growth factor [PDGF]) have **tyrosine kinase** activity. The kinase activity, located in the cytoplasmic domains of these receptors, causes autophosphorylation of the receptor protein and also phosphorylates certain other proteins.

Consideration of platelet-derived growth factor, **PDGF**, illustrates how one particular growth factor brings about its effects. Interaction of PDGF with its receptor stimulates the activity of phospholipase C (PLC). PLC splits phosphatidylinositol bisphosphate (PIP₂) (found in biologic cell membranes) into inositol trisphosphate (IP₃) and diacylglycerol (DAG) (see [Figure 42–6](#)). Elevations in IP₃ levels result in increased levels of intracellular Ca²⁺, while DAG activates protein kinase C (PKC). Hydrolysis of DAG may release arachidonic acid, which can stimulate production of prostaglandins and leukotrienes, each of which has various biologic effects. Exposure of target cells to PDGF can result in rapid (minutes to 1–2 h) activation of the expression of the genes encoding certain cellular proto-oncogenes (eg, *MYC* and *FOS*) that participate in stimulation of mitosis via effects on the cell cycle (see below). The bottom line is that growth factors interact with specific receptors to stimulate specific signaling pathways that serve to increase or decrease the activities of various genes that affect cell division.

MICRO-RNAS ARE NOW THOUGHT TO BE KEY PLAYERS IN CARCINOGENESIS AND TUMOR

METASTASIS

Micro-RNAs (miRNA), discovered in 1993, are nonprotein-coding RNA molecules that are ~22 nucleotides long (see [Chapters 34, 36](#)). miRNAs are expressed in different tissue and cell types and are known to be involved in regulation of gene expression by decreasing mRNA translation or mRNA stability (see [Figures 36–17](#)).

miRNA expression has been found to be dysregulated in many cancers. Such misregulation is thought to have a causal role in the pathogenesis of such cancers. Some types of miRNAs are oncogenic (referred to as oncomiRs) and are overexpressed in cancerous tissue. On the other hand, tumor-suppressive miRNAs that counteract oncogenic characteristics are found to be underexpressed in cancers; the similarity to oncogenes and tumor suppressors described previously is apt. Examples of oncogenic microRNAs include the miR-17-92 polycistronic miRNA encoding gene cluster (implicated in cancers of the lung, breast, pancreas, colon, etc); miR-21 (in cancers of the lung, breast, etc); and miR-155 (in lung cancer and lymphoma). Examples of tumor suppression microRNAs include let-7 (dysregulated in ovarian and lung cancer), miR-34 (implicated in various types of cancers), miR-15, and miR-16 (both involved in chronic lymphocytic leukemia).

MicroRNAs have also been shown to influence extrinsic factors that modulate tumors. These include interactions between the immune system and cancer cells, interactions of stromal cells, effect on oncoviruses, etc. It is likely that the balance of protein expression levels resulting from the exact miRNAs and their concentrations determines whether the net effect of a specific miRNA is oncogenic or tumor suppressive.

The use of miRNAs in clinical applications is gaining ground. miRNAs are being investigated as biomarkers for cancer diagnosis, prognosis, and classification. These small RNAs also hold promise in therapy, where oligonucleotides are used to enhance expression of tumor suppressor miRNAs in cells or antisense oligonucleotides are employed to counter the action of oncogenic miRNAs. Several such miRNA-targeted therapeutics have been developed. These include a mimic of miR-34, which has now reached clinical trials. Interestingly, an anti-miR against miR-122 is also in clinical trials for the treatment of hepatitis.

Another important clinic-based application of miRNAs lies in their ability to potentiate therapeutic responses during anticancer chemotherapy and radiotherapy. Thus, the use of miRNAs as specific targets for treatment and/or for therapeutic supplementation in the management of

cancer appears highly promising. However, as with all gene-based therapies effective delivery of stable oligonucleotides into appropriate target cells is extremely challenging. Nevertheless, tremendous advances in scientific and pharmaceutical developments are anticipated in this area in the years ahead, bringing to clinical practice a group of new and novel therapeutic agents for the treatment of cancers.

EXTRACELLULAR VESICLES AND CANCER

Extracellular vesicles (EVs; aka exosomes and microvesicles) are a group of small vesicles with a lipid bilayer that are released by a wide range of cells, both normal and diseased. These vesicles vary from one another in their size and the way in which they are formed (see [Figure 40–23](#)). Collectively, noncoding RNAs (ncRNA) (comprising miRNAs, long noncoding RNAs [lncRNAs], and circular RNAs [circRNAs]; see [Chapters 34, 36](#)) can be loaded into EVs, which are then secreted. Such EV-associated ncRNAs have been shown to exert paracrine effects on surrounding cells (see [Figure 40–23](#)) thereby facilitating intercellular communication. EVs have been shown to transfer information to target cells by mechanisms such as receptor-ligand binding, direct fusion of the EV with the plasma membrane of recipient cells, or by endocytosis. Transfer of ncRNAs in this way has been implicated in the pathogenesis of several diseases; cancer is one such condition, where laboratory studies have shown that EVs can modulate expression of crucial genes that are involved in tumorigenesis.

The effects produced by ncRNA on their target cells include control of cell proliferation, induction of angiogenesis, alterations in the tumor microenvironment and tumor immunity, and even induction of drug resistance. Such EVs have also been shown to act on distant organs, thereby affecting metastasis.

EV-associated ncRNAs are highly stable. They are found in blood, urine, and saliva. Hence, they have the potential to be used as noninvasive biomarkers to aid in diagnosis and prognosis of cancers. In addition, due to their small size, and lipid bilayer constitution, EVs can readily cross biologic membranes. Consequently, EVs may be used as effective delivery systems to transfer specific molecules (miRNA or anti-miRNA) that can be used in the treatment of disease. Further in vivo work with model systems will be required to explore this exciting new area of oncology.

EPIGENETIC MECHANISMS ARE INVOLVED IN

CANCER

There is growing evidence that epigenetic mechanisms (see [Chapter 36](#)) are involved in the causation of cancer. Such mechanisms produce nonmutational changes that affect regulation of gene expression. Methylation of specific cytosine bases in genes is implicated in turning off activities of certain genes. Changes in the normal pattern of methylation/demethylation of cytosine residues in specific genes have been detected in cancer cells. Histone posttranslational modifications (ie, acetylation, ADP-ribosylation, methylation, phosphorylation, sumoylation, and ubiquitylation; see [Chapters 35, 38](#)), for example, changes in acetylation of histones H3 and H4, which affect gene transcription, have been found in cancer cells. Mutations affecting the structure and/or activity of nucleosome remodeling complexes (ie, SWI/SNF complex) involved in chromatin remodeling can also affect gene transcription. Indeed, several of the components of the SWI/SNF complexes may act as tumor suppressor genes.

A matter of particular interest regarding epigenetic changes in gene expression is that many of these protein and DNA modifications are potentially reversible. In this regard, **5-azadeoxycytidine** and **decitabine** are inhibitors of **DNA methyltransferases (DNMTs)**, while **valproic acid** and **vorinostat** act to inhibit **histone deacetylases (HDACs)**. Both of these agents have been used to treat certain types of leukemias and lymphomas and are thought to work by derepressing the transcription of certain critical growth-regulatory genes, such as tumor suppressors. The increasing use of various -omic technologies to study epigenetic changes in many types of cancers will likely add considerably to knowledge in this area, while hopefully driving the rationale for new chemotherapeutic development.

A NUMBER OF CANCERS DISPLAY A HEREDITARY PREDISPOSITION

It has been known for many years that certain cancers have a hereditary basis. Depending on the specific cancer type, it has been estimated that 5 to 15% of cancers have a hereditary etiology. The discovery of oncogenes and tumor suppressor genes has allowed investigations of the basis of this phenomenon. Many hereditary types of cancer have now been recognized; a few of these are listed in [Table 56–9](#). In a number of cases, where a hereditary syndrome is suspected, appropriate genetic screening of

families has allowed early interventions to be made. For example, some young women who have inherited either a mutated *BRCA1* or *BRCA2* gene have opted for prophylactic mastectomies to prevent cancer of the breast occurring in later life.

TABLE 56–9 Some Hereditary Cancer Conditions

Condition	Gene	Major Function	Major Clinical Feature
Adenomatous polyposis of the colon (OMIM 175100)	<i>APC</i>	See Table 56–7	Development of early-onset adenomatous polyps, which are immediate precursors of colorectal cancers
Breast cancer 1, early onset (OMIM 113705)	<i>BRCA1</i>	DNA repair	About 5% of women with breast cancer in North America carry mutations in this gene or in <i>BRCA2</i> . Also substantially increases risk of ovarian cancer
Breast cancer 2, early onset (OMIM 600185)	<i>BRCA2</i>	DNA repair	As stated above for <i>BRCA1</i> . Mutations in this gene also increase the risk of ovarian cancer, but to a lesser extent
Hereditary nonpolyposis cancer, type I (OMIM 120435)	<i>MSH2</i>	DNA mismatch repair	Early onset of colorectal cancers
Li-Fraumeni syndrome (OMIM 151623)	<i>P53</i>	See Table 56–6	A rare syndrome involving cancers at different sites, developing at an early age
Neurofibromatosis, type 1 (OMIM 162200)	<i>NF1</i>	Encodes neurofibromin	Presentation varies from presence of a few café au lait spots to development of thousands of neurofibromas
Retinoblastoma (MIM 180200)	<i>RB1</i>	See Table 56–6	Hereditary or sporadic retinoblastoma ^a

ABNORMALITIES OF THE CELL CYCLE ARE UBIQUITOUS IN CANCER CELLS

Knowledge of **the cell cycle** is necessary for understanding the molecular mechanisms involved in the development of many types cancer. It is also of importance because many anticancer drugs act only against cells that are dividing, or in a certain phase of the cycle.

Basic aspects of the cell cycle were described in [Chapter 35](#). As shown in [Figure 35–20](#), the cycle has four phases: G_1 , S , G_2 , and M . If cells are not in one of these phases, they are said to be in the G_0 phase and are termed quiescent. Cells can be recruited into the cycle from G_0 by various influences (eg, certain growth factors). Cancer cells usually have a shorter generation time than normal cells, and there are fewer of them in the quiescent G_0 phase.

The roles of various **cyclins**, **cyclin-dependent kinases (CDKs)**, and a

number of other important molecules that affect the cell cycle (eg, the protein products of the *RB* and *P53* genes) were also described in [Chapter 35](#). The points in the cycle, at which some of these molecules act, are indicated in [Figures 35–20, 35–21](#) and [Table 35–7](#).

Because a major property of cancer cells is uncontrolled growth, many aspects of their cell cycle have been studied in considerable depth. Only a few results can be mentioned here. A variety of mutations that affect cyclins and CDKs have been reported. Many products of proto-oncogenes and tumor suppressor genes play important roles in regulating the normal cell cycle. A wide variety of mutations have been found in these types of genes, including *RAS*, *MYC*, *RB*, *P53* (which are among the most studied, see below) and many others.

For example, as discussed in [Chapter 35](#), the protein product of the *RB* gene is a cell cycle regulator. It acts by binding to a transcription factor E2F, thereby blocking transcription of the genes required for progression of the cell from G1 to S phase. Mutation-induced loss of RB protein function thus removes this element of control of the cell cycle.

When damage to DNA occurs (by radiation or chemicals), the p53 protein increases in amount and activates transcription of genes that delay transit through the cycle. If the damage is too severe to repair, p53 activates genes that cause apoptosis (see below, and [Figure 35–23](#)). If p53 is absent or inactive due to mutations, apoptosis does not occur and cells with damaged DNA persist, potentially becoming progenitors of cancer cells.

GENOMIC INSTABILITY AND ANEUPLOIDY ARE IMPORTANT CHARACTERISTICS OF CANCER CELLS

As referred to above and also later in this chapter, cancer cell genomes carry many mutations. One possible explanation for their **genomic instability** is that they have **a mutator phenotype**. The idea of mutator phenotypes was originally postulated by Loeb and colleagues, who argued that mutator phenotypes were caused by cancer cells having acquired mutations in genes involved in DNA replication and DNA repair, thus allowing mutations to accumulate. The concept was later expanded to include mutations that affect chromosomal segregation, DNA damage surveillance, and processes such as apoptosis. Increasing evidence suggests that collectively these various mechanisms, termed errors in

genome replicative functions, contribute to a very large fraction of cancers.

The term genomic instability is frequently used to refer to two abnormalities shown by many cancer cells, **microsatellite** and **chromosomal instability (CIN)**. **Microsatellite instability** was described briefly in [Chapter 35](#). It involves expansion or contraction of microsatellite DNA sequences, usually due to abnormalities of mismatch repair or replication slippage. CIN occurs more often than microsatellite instability, and the two are often mutually exclusive. CIN refers to gain or loss of chromosomes caused by abnormalities of chromosomal segregation during mitosis.

Another area of interest regarding CIN is **copy number variation (CNV)** (see Glossary; [Chapter 39](#)). Associations of various CNVs with many cancers have been identified, and their precise roles in cancer are under investigation.

An important aspect of CIN is **aneuploidy**, a very common feature of solid tumors. Aneuploidy exists when the chromosomal number of a cell is not a multiple of the haploid number. The degree of aneuploidy often correlates with a poor prognosis. This has suggested that abnormalities of chromosomal segregation may contribute to tumor progression by increasing genetic diversity. Some scientists believe that aneuploidy is a fundamental aspect of cancer.

Much research is aimed at determining the basis of CIN and aneuploidy. As shown in [Figure 56–8](#), a number of different processes are involved in normal chromosomal segregation. Each process is complex, and involves various organelles and many individual proteins. A textbook of cell biology should be consulted for details of the process of chromosomal segregation and cell division. Studies are in progress to compare these processes in normal and tumor cells, and to determine which of the differences detected may be contributors to CIN and aneuploidy. One hope of this line of research is that it might be possible to develop drugs that diminish or even prevent CIN and aneuploidy.

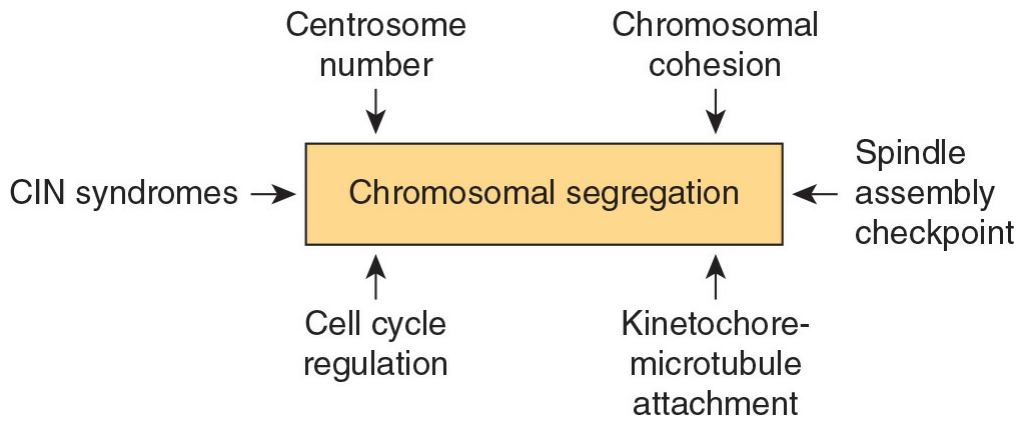

FIGURE 56–8 Factors involved in chromosomal segregation, which are relevant to understanding chromosomal instability (CIN) and aneuploidy. CIN syndromes include Bloom syndrome (OMIM 210900) and others. (Based on Thompson SL, et al: Mechanisms of chromosomal instability. *Curr Biol* 2010;20(6):R285.)

MANY CANCER CELLS DISPLAY ELEVATED LEVELS OF TELOMERASE ACTIVITY

There has been considerable interest in the involvement of telomeres in a number of diseases and also in aging (see [Chapters 35, 57](#)). With respect to cancer, when tumor cells divide rapidly their telomeres often shorten. Such shortened telomeres have been implicated as a risk factor for many, but not all, solid tumors (eg, breast cancer). **Short telomeres** appear to be of predictive value with regard to the progression of chronic inflammatory diseases (such as ulcerative colitis and Barrett esophagus) to cancer. Abnormalities of telomere structure and function can contribute to CIN (see above). The activity of **telomerase**, the main enzyme involved in synthesizing, and thus maintaining the length of telomeres, is very low in normal somatic cells, but is frequently elevated in cancer cells, providing a mechanism for overcoming telomere shortening. Hence, inhibiting telomerase activity represents an attractive target of cancer chemotherapy as most cancer cells exhibit elevated activity of this enzyme, unlike normal somatic cells that display very low activity. However, any such inhibitor would also adversely affect normal stem cells (a ubiquitous class of essential cells found in most tissue types and that require telomerase activity for their regenerative function). This is a major limitation to such an approach. However, Imetelstat (GRN163L) is one such agent that has reached clinical trials. Time will tell if telomerase is an effective target for chemotherapy.

CANCER CELLS HAVE ABNORMALITIES OF APOPTOSIS THAT PROLONG THEIR PROLIFERATIVE CAPACITY

Apoptosis is a genetically directed program, which when activated, **causes cell death**. The main proteins involved in apoptosis are proteolytic enzymes termed **caspases** that normally exist in inactive forms, the **procaspases**. The name caspase is derived from the fact that these enzymes utilize an active site cysteine to cleave polypeptide chains immediately after aspartic residues. About 15 human caspases are known, although not all participate in apoptosis. When those involved in apoptosis are activated (mainly caspases 2, 3, 6, 7, 8, 9, and 10), they participate in a **cascade** of events (compare with the coagulation cascade, [Chapter 55](#)) that ultimately kills cells by digesting various proteins and other molecules. The **upstream caspases** (eg, 2, 8, and 10) at the beginning of the cascade are often called **initiators**, and those downstream at the end of the pathway (caspases 3, 6, and 7) are called **effectors** or **executioners**. A **caspase-activated DNase (CAD)** fragments DNA, thereby producing a characteristic DNA laddering pattern that is readily detected by native gel electrophoresis. Microscopic features of apoptosis include condensation of chromatin, changes of nuclear shape, and membrane blebbing. The resulting dead cells are rapidly disposed of by phagocytic activity, avoiding an inflammatory reaction.

Apoptosis differs from **necrosis**, a pathologic form of cell death that is not genetically programmed. Necrosis occurs on exposure to external agents, such as certain chemicals and extreme heat (eg, burns). Various hydrolytic enzymes (proteases, phospholipases, nucleases, etc) are involved in necrosis. Release of cell contents from dying cells can cause local inflammation, unlike apoptosis.

The overall process of apoptosis is complex and tightly regulated. The apoptotic regulatory pathway involves proteins that act as receptors and adapters, procaspases and caspases, and pro- and anti-apoptotic factors. There are two major pathways, **extrinsic** (death receptor) and **intrinsic**, with **mitochondria** being important participants in the latter pathway. [Figure 56–9](#) shows a simplified diagram of some of the key events in apoptosis.

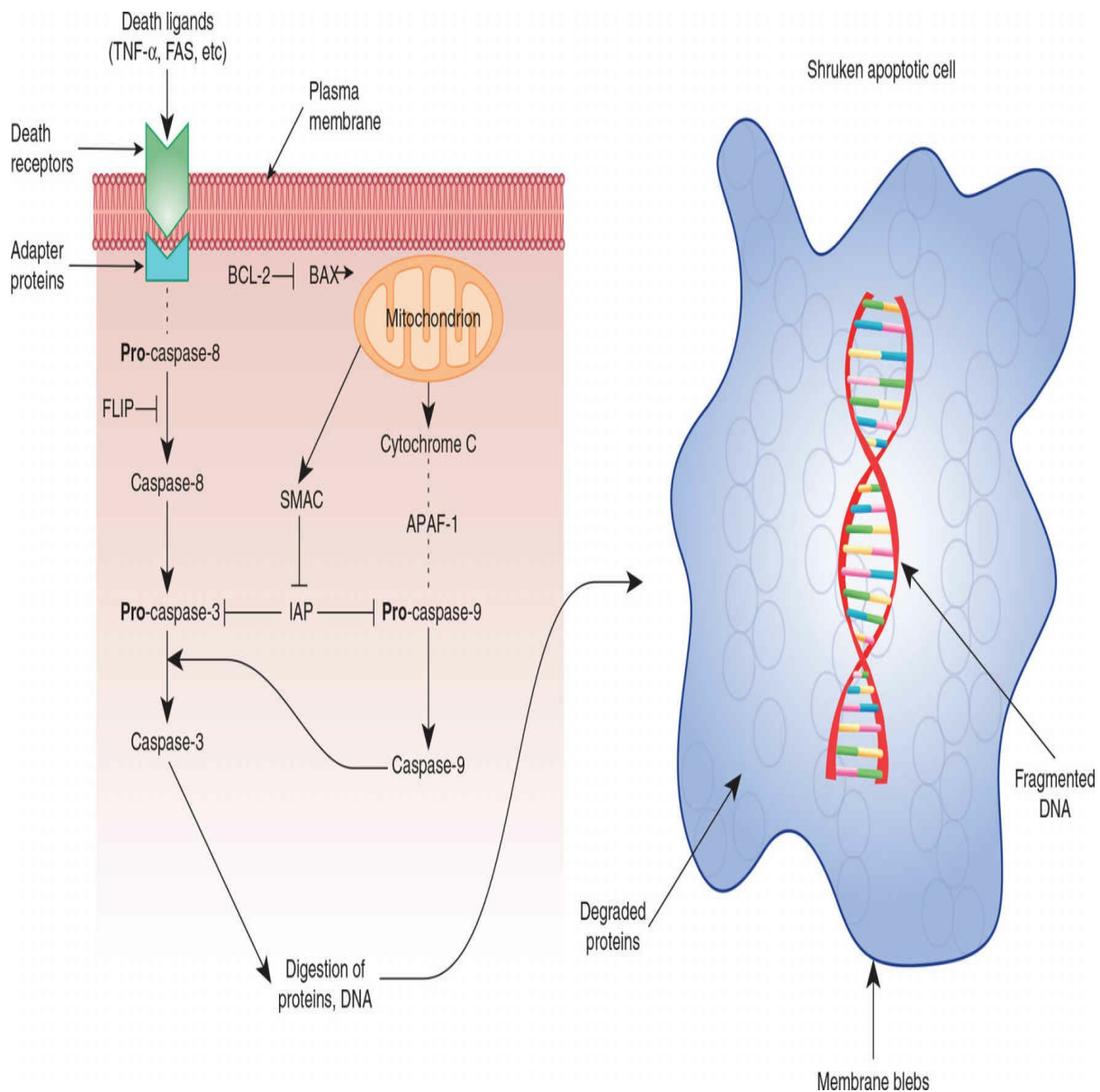

FIGURE 56–9 Simplified scheme of apoptosis. The major molecular events in the extrinsic pathway. Death signals include TNF- α and FAS (present on the surface of lymphocytes and some other cells). The signals (ligands) interact with specific death receptors (there are a number of them) Left. The activated receptor then interacts with an adapter protein (FADD is one of a number of them), and then forms a complex with procaspase 8. (The complex is indicated by the ... between the receptor and procaspase-8 in the figure). Through a series of further steps, active caspase-3 is formed, which is a major effector (executioner) of cell damage. Regulation of the extrinsic pathway can occur due to the inhibitory effect of FLIP on the conversion of procaspase-8 to caspase-8, and also the inhibitory effect of IAP on procaspase-3. The major cellular events in the intrinsic (mt) pathway. Various cell stresses affect the

permeability of the mt outer membrane, resulting in efflux of cytochrome c into the cytoplasm. This forms a multiprotein complex with APAF-1 and procaspase-9, called an apoptosome. Through these interactions, procaspase-9 is converted to caspase-9. This, in turn, can act on procaspase-3 to convert it to its active form. Regulation of the intrinsic pathway can occur at the level of BAX, which facilitates increasing mitochondrial permeability permitting efflux of cytochrome c, and is thus pro-apoptotic. BCL-2 opposes this effect of BAX and is thus anti-apoptotic. IAP also inhibits procaspase-9, and this effect of IAP can be overcome by SMAC. (APAF-1, apoptotic protease activating factor-1; BAX, BCL-2-associated X protein; BCL-2, B-cell CLL/lymphoma 2 (CLL represents chronic lymphatic leukemia); FADD, FAS-associated via death domain; FAS, FAS antigen; FLICE, FADD-like ICE; FLIP, FLICE inhibitory protein; IAP, inhibitor of apoptosis proteins; ICE, interleukin-1- β convertase; SMAC, second mitochondria-derived activator of caspase.) — signifies opposes the action of.

Major features of **the death receptor pathway** are shown on the left-hand side of the figure. **External signals** initiating apoptosis include tumor necrosis factor α (TNF- α) and Fas ligand. A number of death receptors have been identified. These receptors are transmembrane proteins, some of which interact with **adapter proteins** (such as FADD [Fas-associated protein with death domain]). These complexes in turn interact with **procaspase-8**, resulting in its conversion to **caspase-8** (an initiator). **Caspase-3** (an effector) is activated via a series of further reactions. It digests important structural proteins such as lamin (associated with nuclear condensation), various cytoskeletal proteins, and enzymes involved in DNA repair, causing cell death.

Regulation of this pathway occurs at several levels. **FLIP** inhibits the conversion of procaspase-8 to its active form. **Inhibitors of apoptosis (IAPs)** inhibit the conversion of procaspase-3 to its active form. These effects can be overcome by the protein **SMAC** (second mitochondria-derived activator of caspase), which is released from mitochondria.

The **mitochondrial pathway** can be initiated by exposure to reactive oxygen species, DNA damage and other stimuli. Initiation results in the formation of pores in the outer mitochondrial membrane, through which **cytochrome C** escapes into the cytoplasm. In the cytoplasm, cytochrome C interacts with **APAF-1**, **procaspase-9**, and **ATP** to form a multiprotein complex known as the **apoptosome**. As a result of this interaction, **procaspase-9** is converted to its active form and, in turn, acts on

procaspase-3 to produce **caspase-3**.

Activation of the *p53* **gene** upregulates transcription of **BAX**. The **BAX** protein is pro-apoptotic; it causes loss of the mitochondrial membrane potential, thus helping initiate the mitochondrial apoptotic pathway. On the other hand, **BCL-2** inhibits this loss of membrane potential, and is thus anti-apoptotic. IAPs inhibit conversion of procaspase-9 to caspase-9; **SMAC** can overcome this. Note that the death pathway uses **caspase-8** as an initiator, whereas the mitochondrial pathway uses **caspase-9**. These two pathways can interact. In addition, there are also other pathways of apoptosis, which are not discussed here.

Cancer Cells Evade Apoptosis

Cancer cells have developed mechanisms to evade apoptosis, and thus continue to grow and divide. In general, these mechanisms involve mutations that cause loss-of-function of proteins that are pro-apoptotic, or from overexpression of anti-apoptotic genes. One such example concerns loss-of-function of the *P53* gene, perhaps the most commonly mutated gene in cancers. Resultant loss of upregulation of transcription of pro-apoptotic **BAX** (see above) shifts the balance in favor of anti-apoptotic proteins. Overexpression of many anti-apoptotic genes is a frequent finding in cancers. The consequent evasion of apoptosis favors the continuing growth of cancer cells. Attempts are being made to develop drugs that will specifically turn on apoptosis in cancer cells, terminating their lifespans.

As indicated above, apoptosis is a complex, highly regulated pathway with numerous participants, many of which are not mentioned here in this abbreviated account. Apoptosis is also involved in various developmental and physiologic processes. It may seem paradoxical, but regulated cell death is as important in maintaining health, as is formation of new cells. In addition to cancer, apoptosis is implicated in other diseases, including certain autoimmune and chronic neurologic disorders, such as Alzheimer disease and Parkinson disease, where **excessive cell death** (rather than excessive growth) is a feature. **Table 56–10** summarizes some of the principal features of apoptosis.

TABLE 56–10 Summary of Some Important Features of Apoptosis

- It involves a genetically programmed series of events and differs from necrosis, which is a result of direct cellular damage.
- The series of cellular events involved is a cascade, similar to the process of blood coagulation.
- It is characterized by cell shrinking, membrane blebbing, absence of inflammation, and a distinct electrophoresis pattern (laddering) of degraded DNA.
- Many caspases (proteinases) are involved; some are initiators and others act as effectors (executioners).
- Apoptosis can occur either by extrinsic (death receptor-mediated) or intrinsic (mitochondrial) pathways.
- FAS and other receptors are involved in the extrinsic pathway of apoptosis.
- Cellular stress and other factors activate the intrinsic (mitochondrial) pathway of apoptosis; release of cytochrome c into the cytoplasm is an important event in this pathway.
- Apoptosis is regulated by a balance between inhibitors (anti-apoptotic factors) and activators (pro-apoptotic factors) of the process.
- Acquired mutations found in cancer cells enable them to evade apoptosis, thus promoting cell proliferation.

Pro-Inflammatory and Tumor-Promoting Effects of Necrosis

Unlike apoptosis, necrosis of tissue results in release of intracellular contents into the surrounding microenvironment. These include molecules that serve as mediators of the proinflammatory response resulting in the infiltration of tissue by immune inflammatory cells. It has been shown that such cells can have active tumor-promoting effects. Immune inflammatory cells have been reported to promote angiogenesis, cell proliferation, and invasiveness. Necrosis, which appears to counter the proliferative tendency of cancerous cells, may paradoxically benefit tumorigenesis. Thus, developing tumors appear to gain by tolerance of some degree of cell necrosis, because this results in recruitment of inflammatory cells that ultimately supply the tumor cells with growth-promoting factors via angiogenesis.

THE TUMOR MICROENVIRONMENT PLAYS A CRITICAL ROLE IN CANCER DEVELOPMENT,

METASTASIS, AND RESPONSE TO TREATMENT

The tumor microenvironment (TME) consists not only of cancer cells, but also a variety of noncancer cells and components of the extracellular matrix. Complex intercellular and stromal interactions occurring in the TME play important roles in cancer cell proliferation, survival, spread (metastasis), and response to treatment. The major noncancer cells present in the TME include those of the immune system (T and B lymphocytes, natural killer cells, and macrophages) and mesenchymal cells (stem cells, myofibroblasts, endothelial cells, and adipocytes).

Although a variety of immune cells infiltrate tumors, their antitumor effector functions are dampened in response to tumor-derived signals. Furthermore, T lymphocytes and macrophages are reprogrammed (eg, by sustained nuclear factor kappa B [NF- κ B] activation; see [Figure 42–10](#)) to promote tumor growth and survival. This allows cancer cells to escape immune surveillance and also co-opts the immune system to accelerate cancer progression. A greater understanding of the role of immune cells in the TME in driving carcinogenesis has opened up a new and important avenue of cancer treatment called immunotherapy (discussed in more detail later in the chapter).

Mesenchymal cells, such as the myofibroblasts and mesenchymal stem cells, are known to facilitate formation of cancer stem cell niches, thus aiding cancer stem cell survival and proliferation. Other mesenchymal cells, such as endothelial cells, respond to paracrine signals in the TME (eg, vascular endothelial growth factor [VEGF]) by promoting tumor angiogenesis and metastasis. Adipocytes in the TME secrete a number of growth factors that support tumor growth. In addition, the extracellular matrix of the TME also contributes to tumor progression by facilitating the formation of cancer stem cell niches, aiding tumor invasion and metastasis. [Figure 56–10](#) shows the typical constituents of the TME.

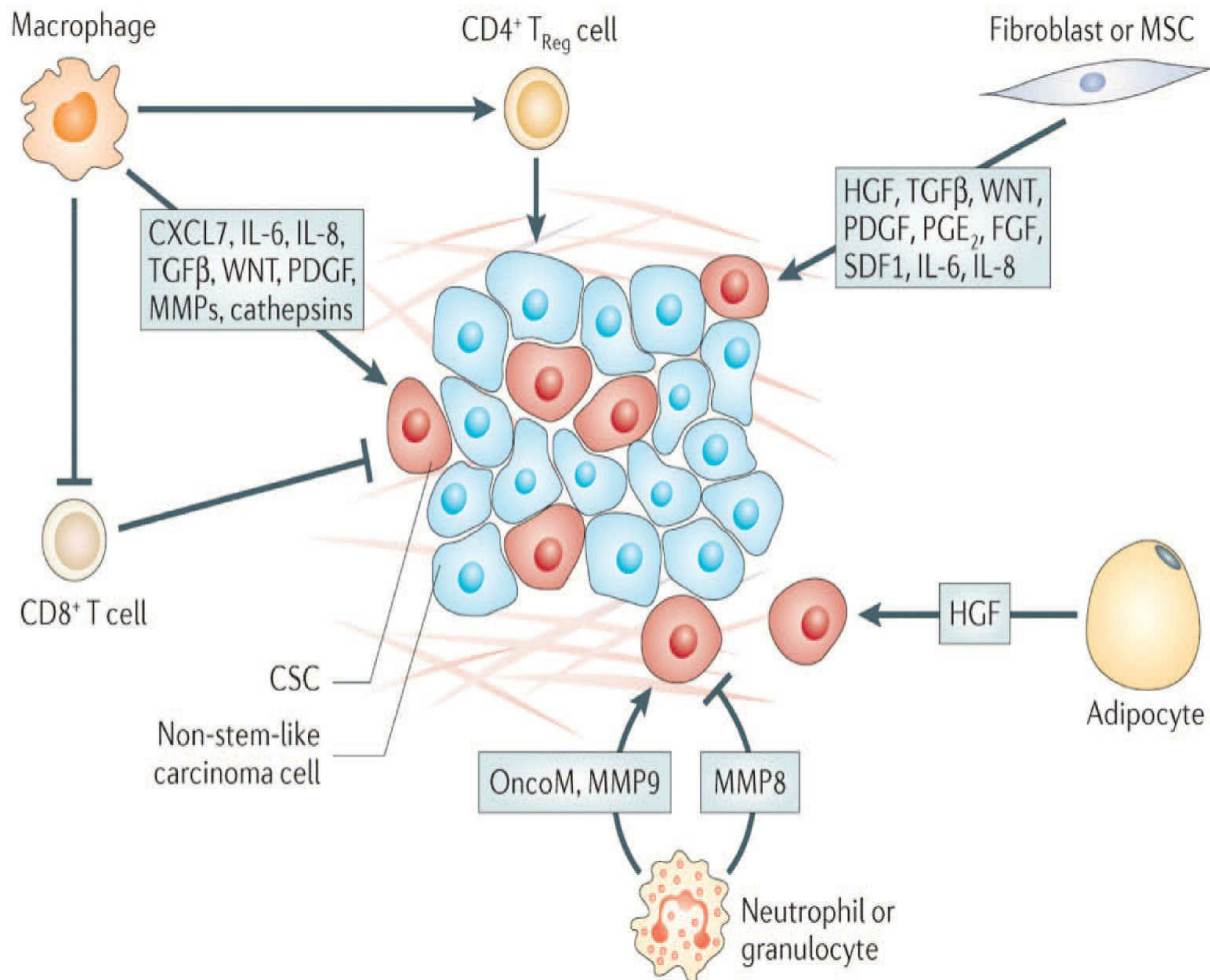

FIGURE 56–10 The tumor microenvironment contributes critically to tumor cell growth. Each cell type depicted affects the tumor by secreting factors that stimulate the formation of cancer stem cells (CSCs) and helping maintain the residence of already formed CSCs in the stem cell state. Summarized here are some of the major cell types and their secreted factors, listed by cell type, that are known to have an impact on CSCs and cancer cells. (CXCL7, CXC-chemokine ligand 7; FGF, fibroblast growth factor; HGF, hepatocyte growth factor; IL-6, interleukin 6; MMP, matrix metalloproteinase; MSC, mesenchymal stem cell; OncoM, oncostatin M; PDGF, platelet-derived growth factor; PGE₂, prostaglandin E₂; SDF1, stromal cell-derived factor 1; TGF-β, transforming growth factor β.) (Adapted from Pattabiraman DR, Weinberg RA. Tackling the cancer stem cells—what challenges do they pose? *Nat Rev Drug Discov* 2014 Jul;13(7):497-512.)

Overall, it is important to note that tumors are not simply a collection of cancer cells; a variety of different types of cells, consisting of both transformed and nontransformed cells, constitute a typical tumor.

Understanding the complex interactions between these cells and their microenvironment is an important aspect of ongoing research in cancer.

CANCER CELLS EXHIBIT ALTERED METABOLIC PROGRAMMING

In order to survive, and ultimately grow and proliferate to form a tumor mass tumor cells must develop the ability to procure all necessary nutrients from typically hypoxic and nutrient-poor environments. Given these immutable facts, it is not surprising that multiple transcriptomic (RNA-seq) studies have shown that genes that code for proteins involved in nutrient capture, uptake and metabolism are often mutated, and/or over-/underexpressed in different types of tumors. These observations have reinvigorated research into metabolism in general, and in cancer cells in particular.

Glucose and the amino acid glutamine are two of the most abundant metabolites in plasma. Together, they account for much of the carbon and nitrogen metabolism in human cells. In 1924, the biochemist Otto Warburg and his colleagues made the discovery that cancer cells take up large amounts of glucose and metabolize it via glycolysis to lactic acid, even in the presence of oxygen. This observation was termed the **Warburg effect**. Based on these data, Warburg proposed two hypotheses: first, that the increased ratio of glycolysis to aerobic respiration was likely to be due to defects in the mitochondrial respiratory chain; and second, that enhanced rates of glycolysis enabled cancer cells to preferentially proliferate in the reduced oxygen tension often seen in tumors. Furthermore, Warburg argued that the switch from aerobic to anaerobic glucose metabolism was a/the driver of tumorigenesis.

It is now thought that the reprogramming of mitochondrial respiration typically observed in tumor cells is a direct effect of at least two kinds of influences, rather than to overt defects in mitochondria. The first of these is the self-sustaining signaling by growth factors that characterizes cancer cells, which causes increased cellular proliferation ([Figures 56–1 and 56–2](#)). The second of these are the genetic changes in specific metabolic enzyme-encoding genes, metabolite transporters, and other related genes. These genetic alterations include preferential expression of certain mRNA splice variants, amplification of particular enzyme-encoding genes, as well as altered catalytic efficiencies and specificities and metabolic products. Collectively, the resulting changes elicit important metabolic rewiring as well as epigenetic changes in the activity of the transcription machinery

(ie, DNA and protein methylation, acetylation, and other posttranslational modifications) that lead to more efficient cellular anabolism and alteration of the tumor microenvironment, which *in toto* allow tumors to proliferate.

An example of tumor cell–specific metabolic rewiring can be illustrated by the example of pyruvate kinase. There are two isozymes, PKM1 and PKM2, which are encoded by the glycolytic pyruvate kinase muscle gene, *PKM*. PKM1 and PKM2 are generated by alternative splicing (see [Chapter 38](#)). Unlike PKM1, which is expressed constitutively in normal cells, PKM2 is often more highly expressed in cancer cells. Likely more important though is the fact that PKM2 exists in either a dimeric form that exhibits very low catalytic activity, or a tetrameric form, with high catalytic activity. PKM2 in cancer cells is most often in the low activity, dimeric form, which results in the accumulation of glycolytic intermediates. These intermediates allow cancer cells to synthesize macromolecules that support rapid proliferation (as proposed in the original Warburg hypothesis). Such **metabolic enzyme reprogramming** ultimately leads to less shuttling of glucose-derived chemical energy into the production of ATP ([Figure 56–11](#)), with a concomitant shunting of such energy into building up the cellular biomass of proteins, lipids, nucleic acids, etc. These macromolecules are essential for cell proliferation (in this case, proliferation of cancer cells). Collectively, these observations help explain why a high rate of glycolysis confers a selective advantage on tumor cells. Based on such observations, a current promising approach is to analyze blood and urine samples by mass spectrometry to look for alterations in metabolite profiles that may help detect cancer at an early stage.

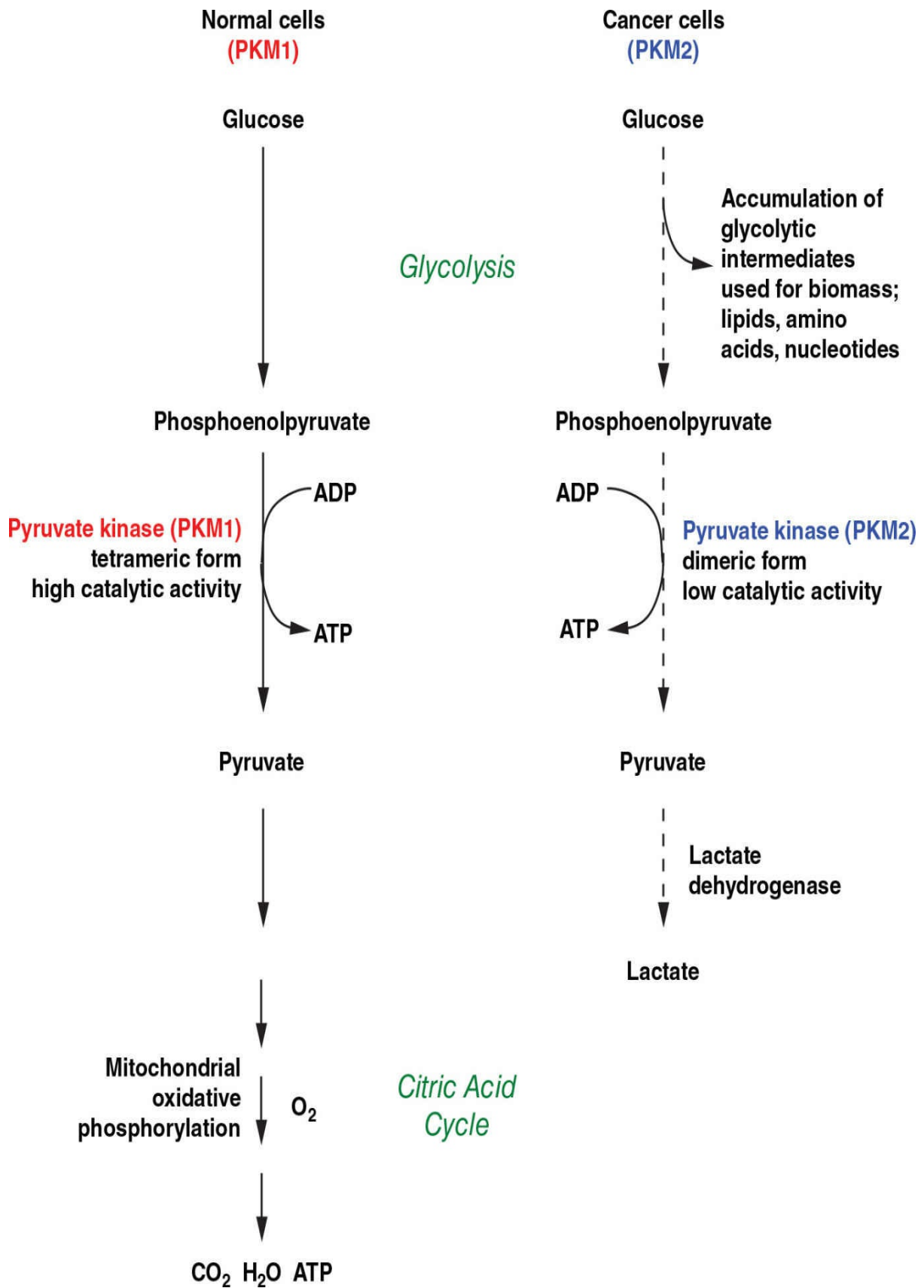

FIGURE 56–11 Pyruvate kinase isozymes and glycolysis in normal and in cancer cells. In normal cells, the major source of ATP is oxidative

phosphorylation. Some ATP is obtained from glycolysis. The major pyruvate kinase (PK) isozyme in normal cells is PKM1. In cancer cells, aerobic glycolysis is prominent, lactic acid is produced via the action of lactate dehydrogenase (LDH) and production of ATP from oxidative phosphorylation is diminished (not shown in the figure). In cancer cells, PKM2 is the major PK isozyme. For complex reasons not as yet fully understood, this change of isozyme profile in cancer cells is associated with decreased net production of ATP from glycolysis, but increased use of metabolites to build up biomass.

Solid tumors typically have localized areas of **poor blood supply**, and as noted above, preferentially utilize glycolytic metabolism and thus secrete lactic acid into the tumor microenvironment, which leads to local **acidosis**. It has been postulated that local TME acidosis allows tumor cells to invade more easily. The **low oxygen tension** in areas of tumors with poor blood supply stimulates the expression of **hypoxia-inducible factor-1 (HIF-1)**. This transcription factor, which is activated by low-oxygen tension, upregulates (among other actions) transcription of at least eight genes that control synthesis of enzymes involved in glycolysis.

The **pH** and **oxygen tension** in tumors are important factors that affect responses to anticancer drugs and other treatments. For example, the anticancer efficacy of radiation treatment of cancers is significantly lower in hypoxic conditions. Chemicals have been developed to inhibit glycolysis in tumor cells, and perhaps selectively kill them (**Table 56–11**). These include **3-bromopyruvate** (an inhibitor of hexokinase-2) and **2-deoxy-d-glucose** (an inhibitor of hexokinase-1). Another compound, **dichloroacetate (DCA)**, inhibits the activity of pyruvate dehydrogenase kinase, and thus stimulates the activity of pyruvate dehydrogenase (see **Chapter 17**), diverting substrate from glycolysis into the citric acid cycle. However, so far, none of these have been found to be clinically useful.

TABLE 56–11 Some Compounds That Inhibit Glycolysis and Have Been Found to Display Variable Anticancer Activity

Compound	Enzyme Inhibited
3-Bromopyruvate	Hexokinase II
2-Deoxy-D-glucose	Hexokinase I
Dichloroacetate	Pyruvate dehydrogenase kinase (PDH)
Iodoacetate	Glyceraldehyde-phosphate dehydrogenase

STEM CELLS IN CANCER

Stem cells were discussed briefly in [Chapters 39](#) and [53](#). Much work is currently ongoing to investigate the role of stem cells in cancer. Cancer stem cells are believed to harbor mutations that, either by themselves or in combination with further mutations, make these cells cancerous. Stem cells can be detected by the use of specific surface markers, or other techniques. It appears that surrounding tissues (eg, components of the extracellular matrix) can significantly influence the behavior of these cells (see [Figure 56–10](#)). An important concept driving some of the research in this area is the belief that one of the reasons that cancer chemotherapy is often not successful is that **a pool of cancer stem cells exists** that is not susceptible to conventional chemotherapy. Reasons for this include the facts that many stem cells are relatively dormant, have active DNA repair systems (see [Figure 35–23](#)), express drug transporters that can expel anticancer drugs, and are often resistant to apoptosis.

Evidence is accumulating that cancer stem cells do indeed play key roles in many types of neoplasia. If so, development of therapies with high specificity for killing these stem cells will be of considerable value.

TUMORS OFTEN STIMULATE ANGIOGENESIS

Tumor cells need an adequate blood supply to provide nutrients for their survival. Both tumor cells and cells in tissues surrounding tumors have been found to **secrete angiogenic factors** that stimulate the growth of new blood vessels. There has been much interest in tumor angiogenesis, because inhibiting this process represents a potential means of killing tumor cells.

The growth of blood vessels that supply tumor cells can be stimulated by **hypoxia** and other factors. As mentioned above, hypoxia induces **HIF-1**, which in turn increases levels of **vascular endothelial growth factor (VEGF)**, a family of proteins that serve as major stimulators of

angiogenesis. VEGF proteins interact with specific tyrosine kinase receptors on endothelial and lymphatic cells. These interactions activate signaling pathways that cause upregulation of the NF- κ B pathway (see [Chapter 42](#)), resulting in proliferation of endothelial cells and formation of new blood vessels. Blood vessels supplying tumors are not normal; their structure is often disorganized, with lower than normal levels of integrity. Consequently, they are often leakier than normal blood vessels. Molecules other than VEGFs, such as **angiopoietin**, **β -fibroblast growth factor (β -FGF)**, **TGF- β** , and **placental growth factor**, also stimulate angiogenesis. Certain other molecules also inhibit blood vessel growth (eg, **angiogenin** and **endostatin**).

Monoclonal antibodies (mAbs) to one form of VEGF have been developed (eg, bevacizumab or Avastatin) and have been used in the treatment of certain types of cancer (eg, colon and breast). These mAbs bind to VEGF and block it from acting, presumably by blocking VEGF from interacting with the VEGF receptor. These therapeutic mAbs were found to increase patient survival, but most patients eventually relapsed. As with many antineoplastic therapies, it is now believed that these mAbs are best used in combination with other anticancer therapies. Monoclonal antibodies to other growth factors that stimulate angiogenesis are also being developed and are in clinical trials, as are small molecule inhibitors of angiogenesis. Inhibitors of angiogenesis are useful in other conditions, such as “wet,” or age-related, **macular degeneration** and **diabetic retinopathy**, in which proliferation of blood vessels is a feature.

METASTASIS IS THE MOST SERIOUS ASPECT OF CANCER

It has been estimated that about **85% of the mortality** associated with cancer results from **metastasis**. Spread of cancer is usually via lymphatics or blood vessels. Metastasis is a complex process, the molecular mechanisms of which are only now beginning to be understood.

Figure 56–12 presents a simplified scheme of metastasis. The earliest event is **detachment** of tumor cells from the primary tumor. The cells can then gain access to the circulation (or lymphatics), a process termed **intravasation**. Once in the circulation, they tend to **arrest** in the nearest small capillary bed. In that site, they **extravasate** and **migrate** through the neighboring **extracellular matrix (ECM)**, before finding a site to settle. Thereafter, if they survive host defense mechanisms, they grow at variable rates. To ensure growth, metastatic cells need an adequate blood supply, as

discussed above.

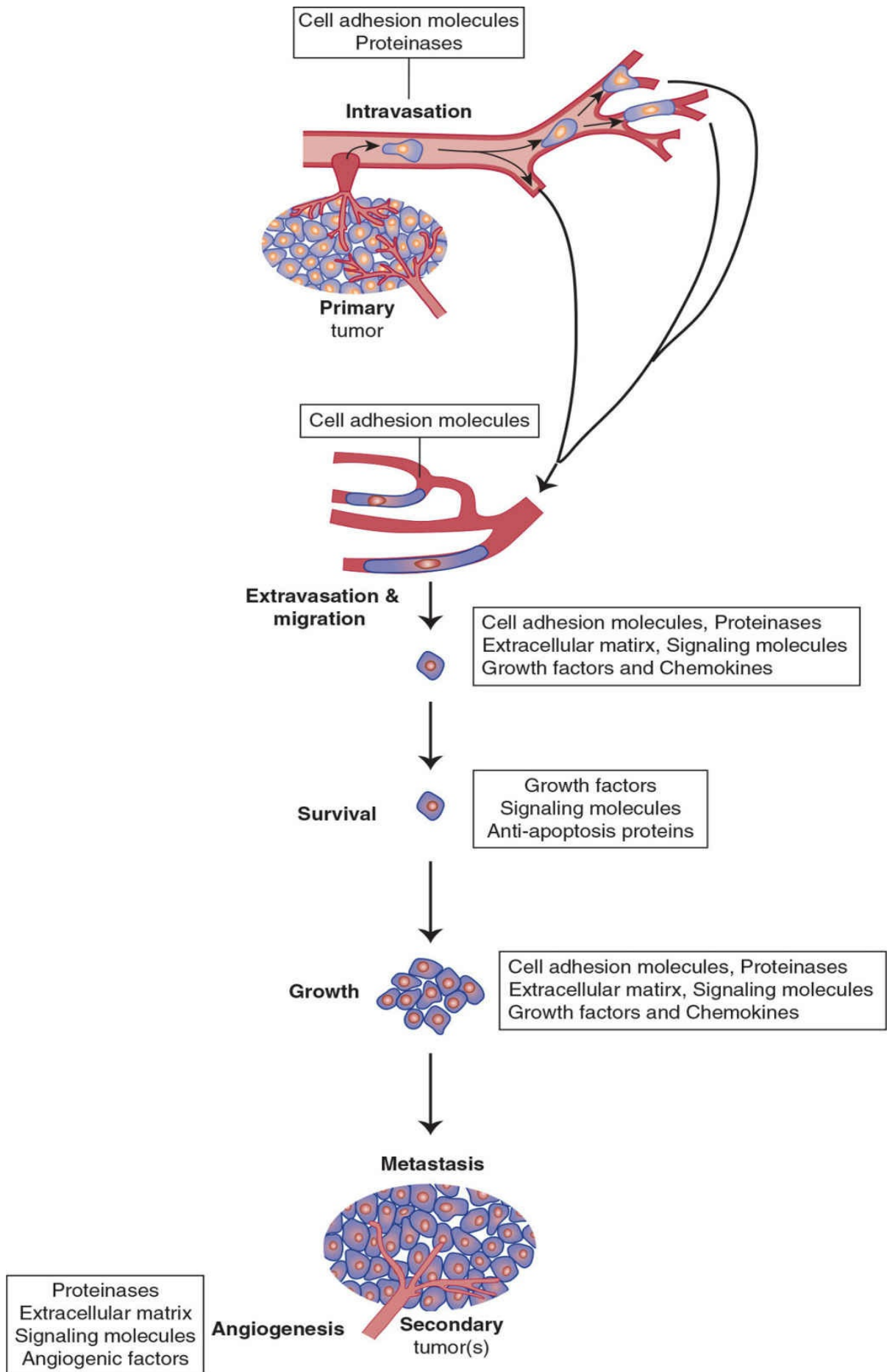

FIGURE 56–12 Simplified scheme of metastasis. Schematic representation of the sequence of steps in metastasis, indicating some of the factors believed to be involved. (From Tannock IF, et al: *The Basic Science of Oncology*, 4th ed. McGraw-Hill, 2005.)

Many studies have shown that cancer cells have an abnormal complement of proteins on their surfaces. These changes may permit decreased cell adhesion and allow individual cancer cells to detach from the parent tumor. Molecules on cell surfaces involved in cell adhesion are called **cell adhesion molecules**, or **CAMs** (**Table 56–12**). Decreases in the amounts of the CAM **E-cadherin**, a molecule of major importance in the adhesion of many normal cells, may help to account for the decreased adhesiveness of many cancer cells. Many studies have shown changes in the oligosaccharide chains of cell surface glycoproteins (see **Figure 40–7**), which occur due to altered activities of various glycosyltransferases (see **Chapter 46**). One such important change is an increase in the activity of GlcNAc transferase V. This enzyme catalyzes transfer of GlcNAc to a growing oligosaccharide chain, forming a β 1-6 linkage and allowing further growth of the chain. It has been proposed that such elongated chains participate in an altered glycan lattice at the cell surface. This may cause structural reorganization of receptors and other molecules, perhaps predisposing to the spread of cancer cells.

TABLE 56–12 Some Important Cell Adhesion Molecules (CAMs)

- Cadherins
- ICAMS, Intercellular adhesion molecules
- Integrins
- Selectins

Another important property of many cancer cells is that they can release various **proteinases** into the ECM. Of the four major classes of proteinases (serine, cysteine, aspartate, and metalloproteinases), in cancer, particular interest has focused on the **matrix metalloproteinases (MMPs)**. MMPs constitute a large family of metal-dependent (usually zinc) enzymes. A number of studies have shown increased activity of MMPs, such as MMP-2 and MMP-9 (also known as gelatinases), in tumors. These enzymes are capable of degrading proteins, such as collagen, in the basement membrane and in the ECM, thereby facilitating the spread of tumor cells.

Inhibitors of these enzymes have been developed, but so far these have not exhibited much clinical success.

Another factor that allows increased movement of cancer cells is **epithelial-to-mesenchymal transition**, or **EMT**. This is a change of cell morphology and function from epithelial to mesenchymal type, perhaps induced by growth factors. Mesenchymal types have more actin filaments, permitting increased movement, an essential property of cells that metastasize.

The ECM also plays an important role in metastasis. There is evidence of communication by signaling mechanisms between cancer cells and those of the ECM. The types of cells in the ECM can also affect metastasis. As mentioned above, proteinases that degrade proteins in the ECM can facilitate spread of cancer cells. In addition, the ECM contains various growth factors that can influence tumor behavior.

On their travels, tumor cells are exposed to various cells of the immune system (such as T cells, NK cells, and macrophages; see [Chapter 54](#)), and must be able to survive exposure to them. Some of these immune surveillance cells secrete various **chemokines**, small proteins that can attract various cells such as leukocytes, sometimes causing an inflammatory response to tumor cells.

It has been estimated that significantly fewer than 1 in 10,000 cancer cells may have the genetic capacity to successfully colonize. Certain tumor cells show a predilection to metastasize to specific organs (eg, prostate cells to bone). It is likely that specific cell surface molecules are involved in this tropism.

Various studies have shown that certain genes enhance metastasis, whereas others act as metastasis suppressor genes. Determining exactly how these genes work is the subject of intense investigation. [Table 56–13](#) summarizes some important points regarding metastasis.

TABLE 56–13 Important Features of Metastasis

- An epithelial-to-mesenchymal cell transition is often found in cancers, allowing detachment and spread of potentially metastatic cells.
- Metastasis is relatively inefficient (only about 1:10,000 tumor cells may have the genetic potential to colonize).
- Metastatic cells must evade various cells of the immune system to survive.
- Changes in cell surface molecules (eg, CAMs and others) are involved in the process.
- Increased proteinase activity (eg, of MMP-2 and MMP-9) facilitates invasion.
- The existence of metastasis-enhancer and suppressor genes has been shown.
- Some cancer cells metastasize preferentially to specific organs.
- Metastasis-gene signatures may be detected by transcriptome/exome analysis; such transcriptome information can be of prognostic value, potentially allowing for personalized therapeutic treatment.

THERE ARE MANY IMMUNOLOGIC ASPECTS OF CANCER

Tumor immunology is a broad area of study; due to the extensive breadth of this field, it can only be dealt with here briefly. It is likely that the normal decline in immune responsiveness that accompanies **aging** plays a role in the increased incidence of cancer in older people. A long-standing hope has been that immunologic approaches to treat cancer (**immunotherapy**), because of their **specificity**, might be able to selectively kill cancer cells. There are many ongoing clinical trials investigating this possibility. These studies involve the use of antibodies, vaccines, and various types of T cells that have been manipulated in one way or another to increase their ability to kill neoplastic cells. One of the methods proven to be effective is the use of antibodies against certain T-lymphocyte surface proteins. For example, antibodies developed against cytotoxic T-lymphocyte antigen 4 (anti-CTLA-4) or programmed death 1 (anti-PD1) have been shown to “remove the brakes” on these cells, thus setting them free to attack cancer cells. Other strategies using modified T cells have proven to be effective as well. The major advantage of immunotherapy is that it has a broad spectrum of action and can therefore be used against a wide variety of cancers. In addition, resistance is less likely to occur to this form of treatment. It is hoped that immunotherapy

will be the fourth major weapon against cancer, after surgery, radiotherapy, and chemotherapy, making it *Science* magazine's "Breakthrough of the Year 2013."

Chronic inflammation involves aspects of immune function. There is evidence that it can **predispose to cancer** (eg, the incidence of colorectal cancer is much higher than normal in individuals who have had long-standing ulcerative colitis). Some inflammatory cells produce relatively large amounts of **reactive oxygen species (ROS)**, which can cause damage to DNA, and perhaps contribute to oncogenesis. It has also been reported that **low doses of aspirin** may lower the risk of development of colorectal cancer, perhaps via its anti-inflammatory action.

Cancer: Its Relationship to Inflammation and Obesity

The association between inflammation and cancer is now well established. Inflammation is known to be a critical component of tumorigenesis. That said, the exact mechanisms linking inflammation and cancer are poorly understood. Examples of possible molecules that are involved in induction of an inflammatory process include nuclear factor kappa B (NF- κ B) and signal transducer and activator of transcription 3 (STAT3). NF- κ B is a transcription factor that induces expression of proteins that are involved in proinflammatory, proliferative, and reparative processes. Activation of NF- κ B has been shown to occur in tumors in response to inflammatory stimuli or oncogenic mutations (see [Chapter 42](#)). Signaling via STAT3 is activated by interleukin 6 (IL-6), a proinflammatory cytokine that activates Janus kinase (JAK)-STAT signaling and its downstream effects (see [Chapter 42](#)). Such events are thought to be responsible for driving many hallmark features of cancer. In addition, the "**inflammasome**," a multiprotein complex that acts as a sensor of cellular damage, is another potential candidate that mediates inflammation. Activation of inflammasomes leads to secretion of **proinflammatory cytokines**, such as **IL-1 β** and **IL-18**, both of which have been implicated in tumorigenesis. There is a large body of evidence to implicate other inflammatory mediators in the development of tumors.

Obesity is associated with low-grade inflammation. Visceral adipose tissue is considered an important source of proinflammatory cytokines. It is now known that the microenvironment surrounding tumor cells influences tumorigenesis (see above). Inflammatory cells in the microenvironment of the tumor are considered to play a crucial role in the process. Obesity has been shown to mediate and exacerbate dysfunctional

changes in the microenvironment; this has been shown to occur both in normal tissue and tumors. Such changes include alterations in factors that may be endocrine, metabolic, or inflammatory in nature. By contrast, caloric restriction has been shown to inhibit tumorigenesis in experimental models. Many cellular pathways, such as those involving growth factor signaling, inflammation, cellular homeostasis, and the tumor microenvironment are affected by such caloric restriction. These observations suggest that such targets may be considered for prevention of cancer in humans.

TUMOR BIOMARKERS CAN BE MEASURED IN SAMPLES OF BLOOD AND OTHER BODY FLUIDS

Biochemical tests are often helpful in the management of patients with cancer (eg, some patients with advanced cancers may have elevated levels of plasma calcium, which can cause serious problems, if not attended to). Many cancers are associated with the abnormal production of enzymes, proteins, and hormones that can be measured in plasma or serum. These molecules are known as **tumor biomarkers**. Some of them are listed in **Table 56–14**.

TABLE 56–14 Some Useful Tumor Biomarkers Measurable in Blood

Tumor Biomarker	Associated Cancer
α-Fetoprotein (AFP)	Hepatocellular carcinoma, germ cell tumor
Calcitonin (CT)	Thyroid (medullary carcinoma)
Carcinoembryonic antigen (CEA)	Colon, lung, breast, pancreas, ovary
Human chorionic gonadotropin (hCG)	Trophoblastic disease, germ cell tumor
Monoclonal immunoglobulin	Myeloma
Prostate-specific antigen (PSA)	Prostate
CA-125	Ovary
CA 19-9	Pancreas

However, significant elevations of some of the biomarkers listed in [Table 56–14](#) also occur in a variety of **noncancerous conditions**. For example, elevations of the level of **prostate-specific antigen (PSA)**, a glycoprotein synthesized by prostate cells, occur not only in patients with cancer of the prostate, but also in patients with prostatitis and **benign prostatic hyperplasia (BPH)**. Similarly, elevations of **carcinoembryonic antigen (CEA)** are found not only in patients with various types of cancer, but also in heavy smokers and people with ulcerative colitis and cirrhosis. The fact that elevations of tumor biomarkers are usually not specific for cancer has meant that measurements of most of them are not used primarily for diagnosis of cancer. Their main uses have been in following the effectiveness of treatments and in detecting early recurrence. As with other laboratory tests (see [Chapter 48](#)), the entire clinical picture must be considered when interpreting the results of measurements of tumor biomarkers.

It is hoped that ongoing **-omic** analyses of body fluids and accessible cancer cells (in blood, serum, and biopsy samples) will provide new **tumor biomarkers** of increased sensitivity and specificity, and those capable of alerting one to the presence of cancers at an early stage of their development. Transcriptome and whole genome sequencing analyses (see [Chapter 39](#) and below) of cancer cells have revealed a plethora of potentially very useful biomarkers of oncogenesis. These methods are also useful in more accurately subclassifying tumors (so-called “personalized medicine”; see [Chapter 39](#)) in order to provide more accurate diagnoses and guide more efficacious, targeted modes of therapy. Such molecular diagnostic methods are becoming the standard of care for a select subset of cancers.

DETAILED GENETIC ANALYSES OF TUMOR CELLS IS PROVIDING NEW INSIGHTS INTO CANCER

Since the completion of the Human Genome Project, the technology of large-scale DNA sequencing and bioinformatic analyses and interpretation of sequence data has advanced considerably. Large-scale DNA sequencing has become both faster and cheaper with the widespread availability of **next-generation sequencing (NGS)** technologies (see [Chapter 39](#)). These advances have allowed for analyses of DNA sequences of a large number of different types of tumors. By sequencing the whole genomes and

exomes of tumors, a **comprehensive catalog** of specific types and numbers of **gene mutations** found in different cancers has been determined. Such information is revolutionizing **diagnostic testing** and the development of **custom-tailored therapy**. In addition, such studies will help identify specific mutations in genes that either cause or accelerate cancers. The former type of mutations are known as **driver** mutations, whereas the latter types are termed as **passenger** mutations. Genome-modulating technologies, such as gene silencing and genome editing (based on CRISPR-based methods), are becoming important tools in such studies.

Tumors often exhibit extreme heterogeneity, such that they consist of subpopulations of cells that are genetically and phenotypically distinct from one another (see [Figure 56–10](#)). It is now possible to isolate and sequence single cells obtained from tumors (**single-cell sequencing**), in order to understand the genetic landscape of a particular tumor. Such understanding is important to develop multimodal treatment strategies that efficiently target all the subpopulations in a given tumor.

Overall, it is expected that information obtained from these new technologies will dramatically impact the next stages of cancer genomics and help in development of methods that allow for early diagnosis of cancer, identification of critical genetic changes that drive cancer progression and, ultimately, personalized therapy for cancer in individual patients. Such an individualized approach to cancer diagnosis and treatment is termed **precision oncology**.

KNOWLEDGE OF MECHANISMS INVOLVED IN CARCINOGENESIS HAS LED TO THE DEVELOPMENT OF NEW THERAPIES

One of the great hopes of cancer research is that insights into fundamental biochemical and genetic mechanisms involved in carcinogenesis will lead to new and better therapies. This has already occurred to a certain extent and it is hoped that ongoing developments will accelerate this process.

Classical chemotherapeutic drugs include alkylating agents, platinum complexes, antimetabolites, mitotic spindle poisons, among other classes of chemical compounds. These agents will not be discussed here. Within the classes of drugs developed more recently are inhibitors of signal transduction (including tyrosine kinase inhibitors), monoclonal antibodies directed to various target molecules, inhibitors of hormone receptors,

drugs that affect differentiation, antiangiogenesis agents, and biologic response modifiers. Examples of each of these are listed in [Table 56–15](#).

TABLE 56–15 Some Anticancer Agents That Are Based on Recent Advances in Knowledge of Cancer Biology

Class	Example	Used to Treat
Inhibitors of signal transduction	Imatinib, an inhibitor of tyrosine kinase	Chronic myelocytic leukemia
Monoclonal antibodies	Trastuzumab, a Mab to the HER2/Neu receptor	Late-stage breast cancer
Antiangiogenesis agents	Bevacizumab, a Mab to VEGF A	Colon and breast cancers
Antihormonal agents	Tamoxifen, antagonist of the estrogen receptor	Breast cancer
Affect differentiation	All-trans retinoic acid (ATRA), targets the retinoic acid receptor on promyelocytic leukemia cells, causing them to differentiate	Promyelocytic leukemia
Affect epigenetic changes	5-Azadeoxycytidine inhibits DNA methyltransferases; SAHA inhibits histone deacetylases	Certain leukemias, cutaneous T-cell lymphoma

The finding of widespread defects in signaling mechanisms in cancer cells, and in particular the detection of mutations in **tyrosine kinases**, has led to the development of inhibitors of these enzymes. The most dramatic success has probably been the introduction of imatinib (marketed as Gleevec) for the treatment of **chronic myelocytic leukemia (CML)**. Imatinib is an orally administered drug that inhibits the tyrosine kinase formed due to the *ABL-BCR* chromosomal translocation that is involved in the genesis of CML. Imatinib, an ATP analog, competitively binds to the ATP-binding pocket of the kinase. This drug has produced complete remissions in many patients. Other tyrosine kinase inhibitors include erlotinib and gefitinib, which inhibit the epidermal growth factor receptor (EGFR). EGFR is overexpressed in certain lung (eg, non–small cell cancers) and breast cancers, resulting in aberrant (constitutive) signaling. It is important to appreciate that the design of such drugs requires detailed structural knowledge such as that provided by x-ray crystallography, NMR studies, and model building of the molecules being targeted. Another class of useful drugs is **monoclonal antibodies** to various molecules exposed on the surfaces of neoplastic cells (see discussion above regarding anti-VEGF mAb). A few of these mAbs that are clinically therapeutically useful are listed in [Table 56–15](#).

Other approaches to treating cancer that are in use or being developed, but are not listed in [Table 56–15](#), include various types of **gene therapy** (including siRNAs, [Chapter 34](#)), **immunotherapy** (see below), **oncolytic**

viruses (viruses that preferentially invade tumor cells and kill them), **inhibitors of steroid hormone receptors, aromatase inhibitors** (see [Chapter 41](#)) (for some breast and ovarian cancers), **telomerase inhibitors**, applications of **nanotechnology** (eg, nanoshells and other nanoparticles), **phototherapy** (see [Chapter 31](#)), and drugs that will **selectively target cancer stem cells**.

It is important to appreciate that anticancer drugs have side effects, just like all other therapeutics. Sometimes, these are severe. Resistance to many drugs can develop after variable periods of time through therapy-driven/selected genetic changes in tumor cells.

The study of mechanisms by which cancer cells develop resistance to drugs is an important area of research. Cancer cells use a number of strategies to develop drug resistance (see summary, [Table 56–16](#)). The overall thrust of drug development for cancer therapy is to use new information that emerges from studies of basic immunology, biochemistry, and cellular, molecular, and cancer biology to develop safer and more effective agents. Intensive research over the past several decades has resulted in an improved understanding of genetic alterations that underlie the development of specific types of cancer. This knowledge has led to a shift from the use of broad-spectrum cytotoxic drugs to therapies that are specifically designed to target individual tumors. Currently, a major area of research is to identify specific **driver mutations**, mutations that play critical roles in development of tumors (see discussion of colorectal cancer above). **Molecular profiling of cancer** in individual patients allows oncologists to choose both the most appropriate drug or treatment modality that targets the molecular abnormality in each tumor, and to monitor the efficacy of such treatment(s) over time. Such **personalized anticancer therapy** has been shown to significantly improve clinical response to drugs and increase survival in various types of cancer. An understanding of individuals' genetic differences in metabolism of anticancer drugs may also help personalize anticancer treatments.

TABLE 56–16 Mechanisms by Which Cancer Cells Can Develop Drug Resistance

Mechanism of Drug Resistance	Example
Increased drug efflux from the cell	Overexpression of transport proteins, such as multidrug resistance proteins (MDRs) (eg, P-glycoprotein or MDR1), causes efflux of cancer chemotherapeutic drugs, such as taxanes, topoisomerase inhibitors, and antimetabolites.
Decreased drug activation	Decreased conversion of prodrugs (eg, 5-fluorouracil) to their active forms due to downregulation of enzymes that catalyze their activation.
Drug inactivation	Platinum drugs (cisplatin and carboplatin) are inactivated by conjugation with glutathione.
Increased drug target expression	Increased expression of thymidylate synthase, the target of antimetabolites such as 5-fluorouracil.
Dysfunctional apoptosis	Overexpression of anti-apoptotic proteins such as the BCL2 family of proteins, and decreased expression of pro-apoptotic proteins such as BAX and BAK.
Activation of prosurvival signaling	Activation of epidermal growth factor receptor (EGFR)-mediated signaling in response to various chemotherapeutic drugs.
Modification of tumor microenvironment	Increased expression of integrins (proteins that attach cells to the extracellular matrix), which inhibits apoptosis and alters drug targets.

Figure 56–13 summarizes some of the targets for drug therapy and some emerging therapies that have developed from studies of fundamental aspects of cancer.

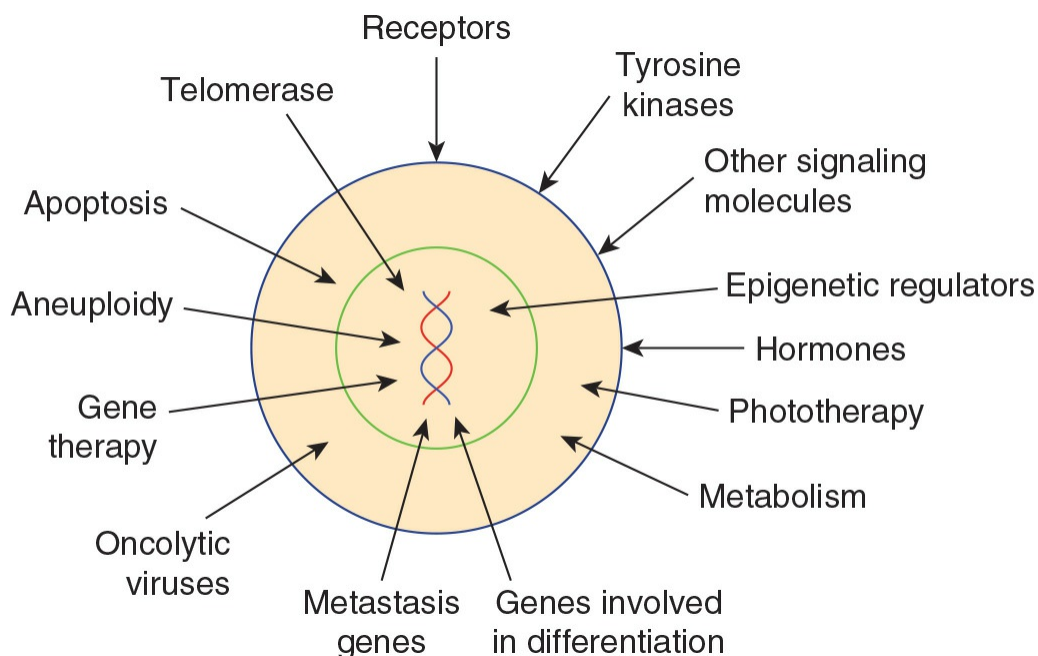

FIGURE 56–13 Examples of targets for anticancer drugs and some emerging therapies, both of which have developed from relatively recent research. Not shown in the figure are antiangiogenic agents,

applications of nanotechnology, therapies directed against cancer stem cells, and immunologic approaches. Most of the targets and therapies indicated are discussed briefly in the text.

MANY CANCERS CAN BE PREVENTED

The tremendous individual suffering caused by cancer, and the heavy economic burden it imposes on society makes it important to adopt measures to **prevent the development of cancer**. **Modifiable risk factors** have been linked to a wide variety of cancers. It is likely that a significant number of all cancers in developed countries could be prevented if the measures summarized in **Table 56–17** were introduced on a population-wide basis.

TABLE 56–17 Public Health Measures That Might Prevent A Significant Number of Cancers if Introduced on a Population-Wide Basis

- Reduced tobacco use
- Increased physical activity
- Weight control
- Improved diet
- Limited alcohol intake
- Use of safer sex practices
- Routine cancer screening tests
- Avoidance of excess exposure to the sun

The use of tobacco, in its various forms, continues to be a major cause of cancer affecting the lungs, mouth, larynx, esophagus, and stomach. A sustained public education campaign regarding the adverse effects of tobacco use has resulted in significant decreases in the incidence of cancers associated with tobacco use. Vaccines against the human papillomavirus (HPV) (known to be associated with cancer of the uterine cervix) and hepatitis B virus (HBV) (associated with hepatocellular carcinoma) have been found to be effective in decreasing the incidence of cancers caused by these viruses.

Chemoprevention, which refers to the use of drugs to prevent the development of cancer, has been found to be effective in certain types of cancer. For example, the use of estrogen receptor modulators (like tamoxifen) has been shown to decrease the incidence of breast cancer in

high-risk women by about 50%. Similarly, the use of finasteride (a drug that inhibits the enzyme, 5 α -reductase, that converts testosterone to dihydrotestosterone), has been associated with reduced incidence of prostate cancer. It has also been shown that long-term use of aspirin, which is commonly prescribed as an antiplatelet agent, is associated with decreased incidence of colon cancer.

In some instances, identification of genetic risk factors for cancer is opening up possibilities for newer strategies in cancer prevention. For example, women who have mutations in the breast-cancer associated genes, *BRCA1* and *BRCA2*, can undergo prophylactic mastectomy (surgery for removal of the breast) in order to mitigate any future risk of developing cancer.

Overall, the rapid progression of research in cancer biology is not only opening up newer ways to treat cancer but also to decrease and/or prevent the occurrence of the disease in the first place.

SUMMARY

- Cancer is caused by mutations in the genes that control cell growth and duplication, cell death (apoptosis), and cell–cell interactions (eg, cell adhesion). Other important aspects of cancer are defects in cell signaling pathways, stimulation of angiogenesis, aneuploidy, and changes in the cellular metabolism and cell microenvironment.
- A majority of cancers are likely due to replicative errors (as broadly defined) that affect somatic cells. However, a number of cancers have been identified that are caused by hereditary or environmental factors.
- Major classes of genes involved in cancer are oncogenes, tumor suppressor genes, and genes encoding proteins important for DNA synthesis, DNA repair, and chromosomal metabolism.
- Mutations affecting genes directing the synthesis and expression of microRNAs are implicated in oncogenesis.
- Epigenetic changes that alter gene expression are increasingly being recognized in cancer (and in other diseases); one reason for interest in epigenetics is that epigenetic “marks” are potentially reversible by drugs.
- Mechanisms of metastasis are being explored intensively; the discovery of metastasis enhancer and suppressor genes, among other findings, may lead to new therapies.
- Apoptosis, programmed cell death, plays important roles in

oncogenesis. Cancer cells acquire mutations that permit them to evade apoptosis, thus prolonging and enabling their continued replication.

- Cancer cells display various alterations of metabolism and of nutrient capture and utilization.
- The development of cancer is a multistep process involving genetic, epigenetic, and microenvironmental changes that confer selective advantages on clones of cells, some of which eventually acquire the ability to metastasize successfully. Because of the diversity of mutations, it is possible that no two tumors have identical genomes.
- Metastasis (the spread of cancer to distant locations) is associated with changes in expression of cell adhesion molecules and modification of the extracellular matrix which allows cancer cells to detach and migrate to distant locations.
- It is likely that the extracellular vesicles (exosomes) released by cancer cells play important roles in cancer progression and metastasis.
- Tumor biomarkers may help in both the early diagnosis of cancer and for monitoring response to treatment as well as detecting recurrences.
- Diagnostic whole genome-, exome-, and circulating tumor-derived DNA sequencing is now able to reveal the important driver and passenger mutations present in many types of cancers and is becoming a powerful complement to patient treatment.
- Advances in understanding the molecular biology of cancer cells have led to the introduction of a number of new therapies, with others in the pipeline.
- Several strategies have proven useful in preventing cancer. These include modification of risk factors (like decrease in tobacco use in its various forms), vaccination against tumor-causing viruses (such as HPV and HBV), use of drugs (antiestrogens in breast cancer), and risk-modifying surgery (mastectomy in women with mutations in *BRCA1* and *BRCA2*).

REFERENCES

- Alexandrov LB, Nik-Zainal S, Wedge DC, et al: Signatures of mutational processes in human cancer. *Nature* 2013;500:415-421.
- Aravanis AM, Lee M, Klausner RD: Next-generation sequencing of circulating tumor DNA for early cancer detection. *Cell* 2017;168:571-574.
- Borrebaick CAK: Precision diagnosis: moving towards protein biomarker

- signatures of clinical utility in cancer. *Nat Rev Cancer* 2017;17:199-204.
- Dawson MA: The cancer epigenome: concepts, challenges, and therapeutic opportunities. *Science* 2017;355:1147-1152.
- Elinav E, Nowarski R, Thaïss CA, et al: Inflammation-induced cancer: crosstalk between tumors, immune cells and microorganisms. *Nature Rev Cancer* 2013;13:759-771.
- Green DR: *Means to an End: Apoptosis and Other Cell Death Mechanisms*. Cold Spring Harbor Press, 2010.
- Hanahan D, Weinberg RA: Hallmarks of cancer: the next generation. *Cell* 2011;144:646-674.
- Holohan C, Van Schaeybroeck S, Longley DB, et al: Cancer drug resistance: an evolving paradigm. *Nat Rev Cancer* 2013;13:714-726.
- Hu D, Shilatifard A: Epigenetics of hematopoiesis and hematological malignancies. *Genes Dev* 2016;30:2012-2041.
- Lawrence MS, Stojanov P, Mermel CH, et al: Discovery and saturation analysis of cancer genes across 21 tumor types. *Nature* 2014;505:495-501.
- Ling H, Fabbri M, Calin GA: MicroRNAs and other non-coding RNAs as targets for anticancer drug development. *Nat Rev Drug Discov* 2013;12:847-865.
- Ma P, Pan Y, Li W, et al. Extracellular vesicles-mediated noncoding RNAs transfer in cancer. *J Hematol Oncol* 2017;10:57.
- Martinez P, Blasco MA: Telomere-driven diseases and telomere-targeting therapies. *J Cell Biol* 2017;216:875-887.
- Otto T, Sicinski P: Cell cycle proteins as promising targets in cancer therapy. *Nat Rev Cancer* 2017;17:79-92.
- Pavalova NN, Thompson B: The emerging hallmarks of cancer metabolism. *Cell Metab* 2016;23:27-47.
- Shi J, Kantoff PW, Wooster R, Farokhzad OC: Cancer nanomedicine: progress, challenges and opportunities. *Nat Rev Cancer* 2017;17:20-37.
- Tomasetti C, Li L, Vogelstein B: Stem cell divisions, somatic mutations, cancer etiology, and cancer prevention *Science* 2017;355:1330-1334.
- Vogelstein B, Papadopoulos N, Velculescu VE, et al: Cancer genome landscapes. *Science* 2013;339:1546-1558. (This is one of four reviews on cancer biology in this issue of *Science*.)
- Weinberg R: *The Biology of Cancer*, 2nd ed. Garland Science, 2013.
- Yachida S, Jones S, Bozic I, et al: Distant metastasis occurs late during the genetic evolution of pancreatic cancer. *Nature* 2010;467(7319):1114-

1117.

Zhao J, Lawless MW: Stop feeding cancer: proinflammatory role of visceral adiposity in liver cancer. *Cytokine* 2013;64: 626-637.

USEFUL WEB SITES

American Cancer Society. <http://www.cancer.org>

National Cancer Institute, U.S. National Institute of Health.

<http://www.cancer.gov>

The Cancer Genome Atlas. <http://cancergenome.nih.gov>

National Cancer Institute Genomic Data Commons. <http://gdc.cancer.gov>

Nature. TCGA (2011, 2012, 2013, 2014). TCGA pan-cancer analysis.

<http://www.nature.com/tcga/>

GLOSSARY

Adenomatous polyp: A benign tumor of epithelial origin that has the potential to become a carcinoma. Adenomas are often polypoid. A polyp is a growth that protrudes from a mucous membrane; most are benign, but some polyps can become malignant.

Ames assay: An assay system devised by Dr Bruce Ames that uses specially designed *Salmonella typhimurium* to detect mutagens. Most carcinogens are mutagens, but if mutagenicity of a chemical is detected, ideally such chemical compounds should be tested for carcinogenicity by animal testing.

Aneuploidy: Refers to any condition in which the chromosome number of a cell is not an exact multiple of the basic haploid number. Aneuploidy is found in many tumor cells and may play a fundamental role in the development of cancer.

Angiogenesis: The formation of new blood vessels. Angiogenesis is often active around tumor cells, ensuring that they obtain an adequate blood supply. A number of growth factors are secreted by tumor and surrounding cells (eg, vascular endothelial growth factor, or VEGF) and are involved in this process.

Apoptosis: Cell death due to activation of a genetic program that causes fragmentation of cellular DNA and other changes. Caspases play a central role in the process. Many positive and negative regulators affect it. The protein p53 induces apoptosis as a response to cell DNA damage. Most cancer cells exhibit abnormalities of apoptosis, due to various mutations that help to ensure their prolonged survival.

Benign tumor: A mass of abnormal proliferating cells whose growth is driven by mutations in at least one tumor suppressor or oncogene. These tumor cells are noninvasive and do not metastasize.

Biologic response modifiers: Molecules produced by the body or in the laboratory that when administered to patients alter the body's response to infection, inflammation, and other processes. Examples include monoclonal antibodies, cytokines, interleukins, interferons, and growth factors.

Bloom syndrome: One of the chromosomal instability (CIN) syndromes. Because of mutations in a DNA helicase, subjects are sensitive to DNA damage and may develop various tumors.

Burkitt lymphoma: This is a B-cell lymphoma, endemic in parts of Africa, where it mainly affects the jaw and facial bones. It is also found elsewhere. A reciprocal translocation involving the *C-MYC* gene on chromosome 8 and the immunoglobulin heavy-chain gene on chromosome 14 is characteristic.

Cancer: A malignant growth of cells.

Cancer stem cell: A cell within a tumor that has the capacity to self-renew and to give rise to the heterogeneous lineages of cancer cells found in the tumor.

Carcinogen: Any agent (eg, a chemical or radiation) capable of causing cells to become cancerous.

Carcinoma: A malignant growth of epithelial origin. A cancer of glandular origin or showing glandular features is usually designated as an adenocarcinoma.

Caspases: Proteolytic enzymes that play a central role in apoptosis, but are also involved in other processes. Some 15 are present in humans. Caspases hydrolyze peptide bonds just C-terminal to aspartate residues.

Cell cycle: The various events pertaining to cell division that occurs as a cell goes from one mitosis to another.

Centriole: An array of microtubules that is paired and found in the center of a centrosome. (Also see **Centrosome**.)

Centromere: The constricted region of a mitotic chromosome where chromatids are joined together. It is in close proximity to the kinetochore. Abnormalities of centromeres may contribute to CIN. (Also see **Kinetochore**.)

Centrosome: A centrally located organelle that is the primary microtubule-organizing center of a cell. It acts as the spindle pole during cell division.

Chromatid: A single chromosome.

Chromatin remodeling: This involves conformational, or covalent changes of nucleosomes brought about by the actions of multiprotein complexes (such as the SW1/SNF complex). These changes alter gene transcription (turning it on or off, depending on specific conditions). Mutations affecting different proteins of these complexes are often found in cancer cells. (See also **Epigenetics**.)

Chromosomal instability (CIN): The rate of gain or loss of whole chromosomes or segments of them caused by abnormalities of chromosome segregation during mitosis. (See also **Genome instability** and **Microsatellite instability**.) There are a number of disorders that are named CIN syndromes because they are associated with chromosomal abnormalities. An increased incidence of various cancers is found in these conditions.

Chromosomal passenger complex: A complex of proteins that plays a key role in regulating mitosis. At the centromere, it directs alignment of the chromosome and participates in spindle assembly. Its proteins include aurora B kinase and survivin. Mutations affecting its proteins may contribute to CI and aneuploidy.

Chromosomal translocation: When part of one chromosome becomes fused to another, often causing activation of a gene at the site. The Philadelphia chromosome (see below) is one of many examples of a chromosomal translocation involved in the causation of cancer.

Clone: All the cells of a clone are derived from one parent cell.

Copy number variations (CNVs): Variations (because of duplications or deletions) among individuals as to the number of copies they have of particular genes. CNVs are being increasingly recognized for various genes, and some may be associated with various diseases, including certain types of cancer.

Driver mutation: A mutation in a gene that either helps cause cancer or accelerates it. Mutations found in tumors that do not cause cancer or its progression are called passenger mutations.

Epigenetic: Refers to changes of gene expression without change of the sequence of bases in DNA. Factors causing epigenetic changes include methylation of bases in DNA, posttranslational modifications of histones, and chromatin remodeling.

FAS receptor: A receptor that initiates apoptosis when it binds its ligand, FAS. FAS is a protein present on the surface of activated natural killer cells, cytotoxic T lymphocytes and other sources.

Gatekeeper: A mutated version of a gene that initiates the cascade of events that cause oncogenesis (eg, *RB*).

Genome instability: This refers to a number of alterations of the genome, of which the two principal ones are CIN and microsatellite instability. In general, it reflects the fact that the genomes of cancer cells are more susceptible to mutations than are normal cells, in part due to impairment of DNA repair systems.

Growth factors: A variety of polypeptides secreted by many normal and tumor cells. These molecules act via autocrine (affects the cells that produce the growth factor), paracrine (affects neighboring cells), or endocrine (travels in the blood to affect distant cells) modes. They stimulate proliferation of target cells via interactions with specific receptors. They also have many other biologic properties.

Hypoxia-inducible factors (HIFs): A family of transcription factors (at least three) important in directing cellular responses to varying levels of oxygen. Each factor is made up of a different oxygen-regulated α subunit and a common constitutive β subunit. At physiologic levels of oxygen, the α subunit undergoes rapid degradation, initiated by prolyl hydroxylases. HIFs have various functions; eg, HIF-1 upregulates various genes encoding enzymes of glycolysis, and also the expression of vascular endothelial growth factor (VEGF).

Kinetochores: A structure that forms on each mitotic chromosome adjacent to the centromere. Mutations affecting the structures of its component proteins could contribute to causing CIN. (See also **Centromere**.)

Leukemias: A variety of malignant diseases in which various white cells (eg, myeloblasts, lymphoblasts, etc) proliferate in an unrestrained manner. Leukemias may be acute or chronic.

Loss of heterozygosity (LOH): This occurs when there is loss of the normal allele (often encoding a tumor suppressor gene) from a pair of heterozygous chromosomes, allowing the results of the defective allele to be manifest clinically.

Lymphoma: A group of neoplasms arising in the reticuloendothelial and lymphatic systems. Major members of the group are Hodgkin and non-Hodgkin lymphomas.

Malignant cells: They are cancer cells—cells with the ability to grow in an unrestrained manner, to invade, and to spread (metastasize) to other parts of the body.

Metastasis: The ability of cancer cells to spread to distant parts of the body and grow there.

Microsatellite instability: Expansion or contraction of short tandem repeats (microsatellites) due to replication slippage, abnormalities of mismatch repair or of homologous recombination. For **Microsatellites**, see [Chapter 35](#).

Nanotechnology: The development and application of devices that are only a few nanometers in size (10^{-9} m = 1 nm). Some are being applied to cancer therapy.

Necrosis: Cell death induced by chemicals or tissue injury. Various hydrolytic enzymes are released and digest cellular molecules. It is not a genetically programmed process, as is apoptosis. Affected cells usually burst and release their contents, causing local inflammation.

Neoplasm: Any new growth of tissue, benign or malignant.

Oncogene: A mutated cellular gene (ie. proto-oncogene) whose protein product is involved in the transformation of a normal cell to a cancer cell.

Oncology: The area of medical science that concerns itself with all aspects of cancer (causes, diagnosis, treatment, etc).

Philadelphia chromosome: A chromosome formed by a reciprocal translocation between chromosomes 9 and 22. It is the cause of chronic myeloid leukemia (CML). To form the abnormal chromosome, part of the *BCR* (breakpoint cluster region) gene of chromosome 22 fuses with part of the *ABL* gene (encodes a tyrosine kinase) of chromosome 9, directing the synthesis of a chimeric protein that has unregulated tyrosine kinase activity and drives cell proliferation. The activity of this kinase is inhibited by the drug imatinib (Gleevec), which has been successfully used to treat CML. (See also **Chromosomal translocation**.)

Procarcinogen: A chemical that becomes a carcinogen when altered by metabolism.

Proto-oncogene: A normal cellular gene, which when mutated can give rise to a product that stimulates the growth of cells, contributing to the development of cancer.

Replication slippage: A process in which, because of misalignment of DNA strands where repeat sequences occur, DNA polymerase pauses and dissociates, resulting in deletions or insertions of repeat sequences.

Retinoblastoma: A rare tumor of the retina. Mutation of the *RB* tumor suppressor gene plays a key role in its development. Patients with hereditary retinoblastomas have inherited one mutated copy of the *RB* gene, and need only one further mutation to develop the tumor. Patients

with sporadic retinoblastomas are born with two normal copies, and require two mutations to inactivate the gene.

Rous sarcoma virus (RSV): An RNA tumor virus that causes sarcomas in chickens. It was discovered in 1911 by Peyton Rous. It is a retrovirus, using reverse transcriptase in its replication; the DNA copy of its genome subsequently integrates into the host cell genome. It has been widely used in studies of cancer, and its use has led to many important findings.

Sarcoma: A malignant tumor of mesenchymal origin (eg, from cells of the extracellular matrix or other sources).

Telomeres: Structures at the ends of chromosome that contain multiple repeats of specific hexanucleotide DNA sequences. The telomeres of normal cells shorten on repeated cell division, which may result in cell death. The enzyme telomerase replicates telomeres and is often expressed in cancer cells, helping them to evade cell death. Telomerase is usually not detected in normal somatic cells.

Translocation: The displacement of one part of a chromosome to a different chromosome or to a different part of the same chromosome. Classic examples are the translocation found in Burkitt lymphoma (see above) and the translocation between chromosomes 9 and 22, which causes the appearance of the Philadelphia chromosome found in chronic myelogenous leukemia. Translocations have been found in many cancer cells.

Transformation: The process by which normal cells in tissue culture become changed to abnormal cells (eg, by oncogenic viruses or chemicals), some of which may be malignant.

Tumor: Any new growth of tissue, but usually refers to a benign or malignant neoplasm.

Tumor suppressor gene: A gene whose protein product normally restrains cell growth, but when its activity is lost or reduced by mutation contributes to the development of a cancer cell.

The Biochemistry of Aging

Peter J. Kennelly, PhD

OBJECTIVES

After studying this chapter, you should be able to:

- Describe the essential features of wear and tear theories of aging.
- List four or more common environmental constituents known to damage biologic macromolecules such as proteins and DNA.
- Explain why nucleotide bases are especially vulnerable to damage.
- Describe the most physiologically important difference between mitochondrial and nuclear genomes.
- Describe the oxidative theory of aging.
- List the primary sources of reactive oxygen species (ROS) in humans.
- Describe three mechanisms by which cells prevent or repair damage inflicted by ROS.
- Describe the basic tenets of metabolic theories of aging.
- Explain the mechanism of the telomere “countdown clock.”
- Outline our current understanding of the genetic contribution to aging.
- Explain the benefits of model organisms to biomedical research.

BIOMEDICAL IMPORTANCE

Consider the various stages in the lifespan of *Homo sapiens*. Infancy and childhood are characterized by continual growth in height and body mass. Basic motor and intellectual skills develop: walking, language, etc. Infancy and childhood also represent a period of vulnerability wherein a youngster is dependent on adults for water, food, shelter, protection, and instruction. Adolescence witnesses a final burst of growth in the body's skeletal framework. More importantly, a series of dramatic developmental changes occur—an accumulation of muscle mass, maturation of the gonads and brain, and the emergence of secondary sex characteristics—that transform a child into an independent and reproductively capable adult. Adulthood, the longest stage, is a period devoid of dramatic physical growth or developmental change. With the notable exception of pregnancy in females, it is not unusual for adults to maintain the same body weight, overall appearance, and general level of activity for two decades or more.

Barring fatal illness or injury, the onset of the final stage of life, old age, is signaled by a resurgence of physical and physiologic change. Muscle and bone mass progressively decrease. Hair begins to thin and lose its pigmentation. Skin loses its suppleness and accumulates blemishes. Attention span and recall decline. Eventually, inevitably, life itself comes to an end as essential bodily functions decline.

Understanding the underlying causes and instigating triggers of aging and the changes that accompany it is of great biomedical importance. Hutchison-Gilford, Werner, and Down syndrome are three human genetic diseases whose pathologies include an acceleration of many of the physiologic events associated with aging. Slowing or preventing some of the degenerative processes that cause or accompany aging can render the later stages of life more vital, productive, and fulfilling. Coopting the factors responsible for triggering cell death may enable physicians to selectively destroy harmful tumors, polyps, and cysts.

LIFESPAN VERSUS LONGEVITY

From Paleolithic to Medieval times the average life expectancy of a newborn baby oscillated in the range of 25 to 35 years. Beginning with the Renaissance, however, this number gradually increased such that, by the beginning of the 20th century, the average life expectancy of persons born in developing countries reached the mid-40s. Today, 100 years later, the

current world average is 67 years, and that for developed nations is approaching 80. These dramatic increases have led to speculation about how long this trend might be expected to continue. Can future generations expect to live past the century mark? Is it possible that human beings possess the potential, with proper care and maintenance, to live indefinitely?

Unfortunately, such extrapolations are unlikely to be realized because they are based on a misunderstanding of the term **life expectancy**. Life expectancy is calculated by averaging over all births. Hence, it is dramatically influenced by infant mortality rates. While the life expectancy of a Roman child was 25 years, if one calculated the expected lifespan only for those persons who survived infancy, which we will refer to as **longevity**, the average nearly doubled to 48. When one factors out the dramatic decline in infant mortality rates that has taken place over the past century and a half, the predicted longevity of a 5-year-old child in the United States has increased from 70.5 in 1950 to 77.5 years in 2000 (**Table 57–1**). Is there some sort of upper limit to the lifespan of a properly nourished, protected, well-maintained human being?

TABLE 57–1 Average Life Expectancy by Decade, USA

Sample Period	Average Life Expectancy (Years)	
	From Birth	If Survived to Age 5
1900-1902	49.24	59.98
1909-1911	51.49	61.21
1919-1921	56.40	62.99
1929-1931	59.20	64.29
1939-1941	63.62	67.49
1949-1951	68.07	70.54
1959-1961	69.89	72.04
1969-1971	70.75	72.43
1979-1981	73.88	75.00
1989-1991	75.37	76.22
1999-2001	76.83	77.47

AGING & MORTALITY: NONSPECIFIC OR PROGRAMMED PROCESSES?

Are aging and death nondeterminant or **stochastic** processes wherein living creatures inevitably reach a tipping point after a lifetime's accumulation of damage from disease, injury, and simple wear and tear? Alternatively, are aging and death genetically programmed processes analogous to puberty that have evolved through a process of natural selection? In all likelihood, aging and death are multifactorial processes to which both stochastic and programmed factors contribute.

WEAR & TEAR THEORIES OF AGING

Many theories regarding aging and mortality hypothesize that the human body eventually succumbs to the accumulation of damage over time as a result of injury and long-term exposure to environmental factors that degrade organic biomolecules. These theories note that while repair and turnover mechanisms exist to restore or replace many classes of damaged molecules, they are less than perfect. Hence, some damage inevitably leaks through—damage that will accumulate over time, particularly among those cell populations that undergo little, if any, turnover (**Table 57–2**). Ironically, many of these agents are essential for terrestrial life: water, oxygen, and sunlight.

TABLE 57–2 Time Required for All of the Average Cells of This Type to Be Replaced

Tissue or Cell Type	Turnover
Intestinal epithelium	34 h ^a
Epidermis	39 d ^b
Leukocyte	<1 y ^c
Adipocytes	9.8 y ^c
Intercostal skeletal muscle	15.2 y ^c
Cardiomyocytes	≥100 y ^c

Hydrolytic Reactions Can Damage Proteins & Nucleotides

Water is a relatively weak nucleophile. However, because of its ubiquity and high concentration ($> 55 \text{ M}$, see [Chapter 2](#)), even this weak nucleophile will occasionally react with susceptible targets inside the cell. In proteins, while hydrolysis of a peptide bond can sever a polypeptide chain, the most vulnerable amide bonds are frequently found on the exposed side chains of the amino acids asparagine and glutamine. Hydrolysis transforms their neutral amides into potentially negatively charged and acidic carboxylates, producing aspartate and glutamate, respectively ([Figure 57–1A](#) and [B](#)). As most of the proteins within a living organism are subject to regular turnover, in many cases the chemically modified protein will eventually be degraded and replaced by a newly synthesized version.

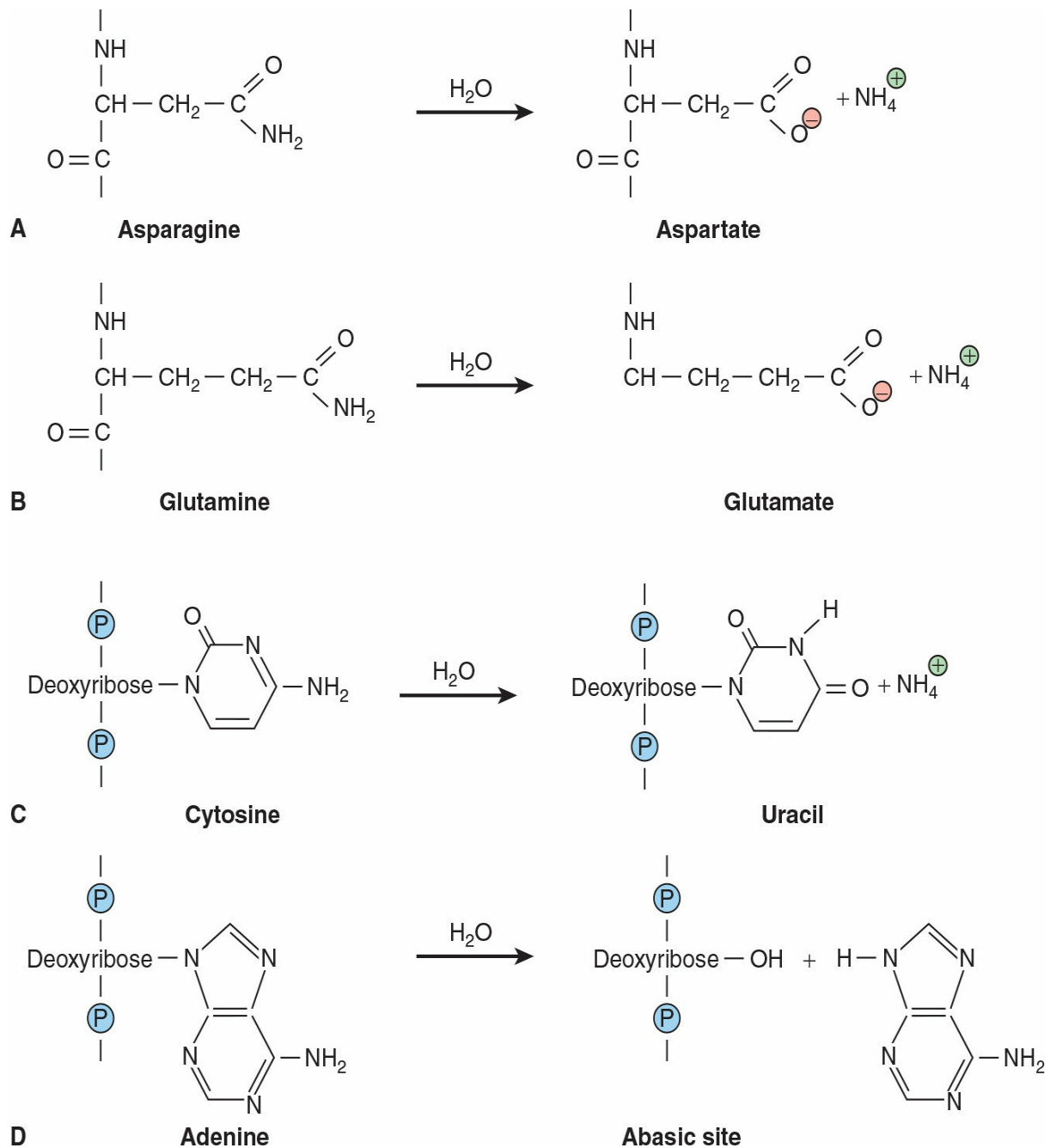

FIGURE 57–1 Examples of hydrolytic damage to biologic macromolecules. Shown are a few of the ways in which water can react with and chemically alter proteins and DNA: **(A)** Net substitution of aspartic acid via hydrolytic deamidation of the neutral side chain of asparagine. **(B)** Net substitution of glutamic acid via hydrolytic deamidation of the neutral side chain of glutamine. **(C)** Net mutation of cytosine to uracil by water. **(D)** Formation of an abasic site in DNA via hydrolytic cleavage of a ribose-base bond.

The amino groups projecting from the heterocyclic aromatic rings of the nucleotide bases cytosine, adenine, and guanine are each susceptible to

hydrolytic attack. In each case, the amino group is replaced by a carbonyl to form uracil, hypoxanthine, and xanthine, respectively (**Figure 57–1C**). The bond between the nucleotide base and the deoxyribose moiety in DNA is also vulnerable to hydrolysis. In this instance the base is completely eliminated, leaving a gap in the sequence (**Figure 57–1D**). The hydrolysis elimination or alternation of nucleotide bases in DNA is of potentially much greater biomedical significance than those affecting proteins, as the former—if left unrepaired (see **Chapter 35**)—will produce a genetic mutation.

Other biologically relevant bonds that are susceptible to hydrolysis include the ester linkages that connect fatty acids to their cognate glycerolipids, the glucosidic bonds that link the monosaccharide units of carbohydrates, and the phosphodiester bonds that hold polynucleotides together and link the head groups of phospholipids to their diacylglycerol partners. In most instances, with the notable exception of polynucleotide chain breaks, the products of these reactions appear to be biologically innocuous.

Respiration Generates Reactive Oxygen Species

Numerous biologic processes require enzyme-catalyzed oxidation of organic molecules by molecular oxygen (O_2). These processes include the hydroxylation of proline and lysine side chains in collagen (see **Chapter 5**), the detoxification of xenobiotics by cytochrome P450 (see **Chapter 47**), the degradation of purine nucleotides to uric acid (see **Chapter 33**), the reoxidation of the prosthetic groups in the flavin-containing enzymes that catalyze oxidative decarboxylation (eg, the pyruvate dehydrogenase complex, see **Chapter 17**) and other redox reactions (eg, amino acid oxidases, see **Chapter 28**), and the generation of the chemiosmotic gradient in mitochondria by the electron transport chain (see **Chapter 13**). Redox enzymes frequently employ prosthetic groups such as flavin nucleotides, iron-sulfur centers, or heme-bound metal ions (see **Chapters 12 and 13**) to assist in generating and stabilizing the free radical and oxyanion intermediates formed during these processes.

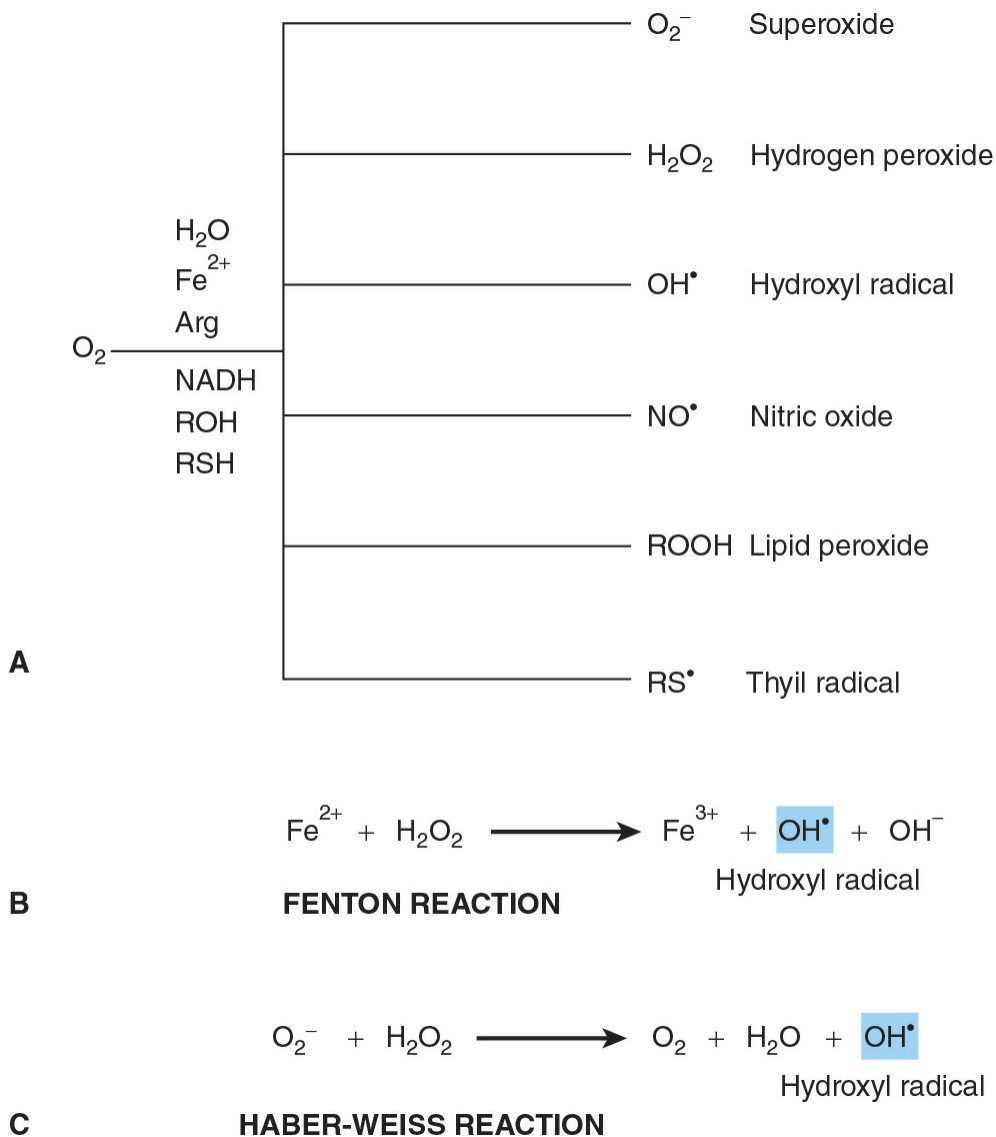

FIGURE 57–2 Reactive oxygen species (ROS) are toxic by-products of life in an aerobic environment. (A) Many types of ROS are encountered in living cells. (B) Generation of hydroxyl radical via the Fenton reaction. (C) Generation of hydroxyl radical by the Haber-Weiss reaction.

Occasionally, these highly reactive intermediates escape to form ROS such as superoxide and hydrogen peroxide inside the cell (**Figure 57–2A**). The most common of these sources is the electron transport chain, whose high levels of electron flux and structural complexity render it vulnerable to “leakage” of ROS. In addition, many mammalian cells synthesize and release nitric oxide (NO^*), a free radical containing second messenger that promotes vasodilation and muscle relaxation in the cardiovascular system (see **Chapter 55**).

Reactive Oxygen Species Are Chemically Prolific

The extremely high reactivity of ROS makes them extremely dangerous. ROS can react with and chemically alter virtually any organic compound, including proteins, nucleic acids, and lipids. ROS also display a strong tendency to form **adducts**—products formed by the combination of precursors—with biologic compounds that contain multiple double bonds such as nucleotide bases and polyunsaturated fatty acids (**Figure 57–3**). Adducts formed with nucleotide bases can be especially dangerous because of their potential, if uncorrected, to cause mutation generating errors during DNA replication.

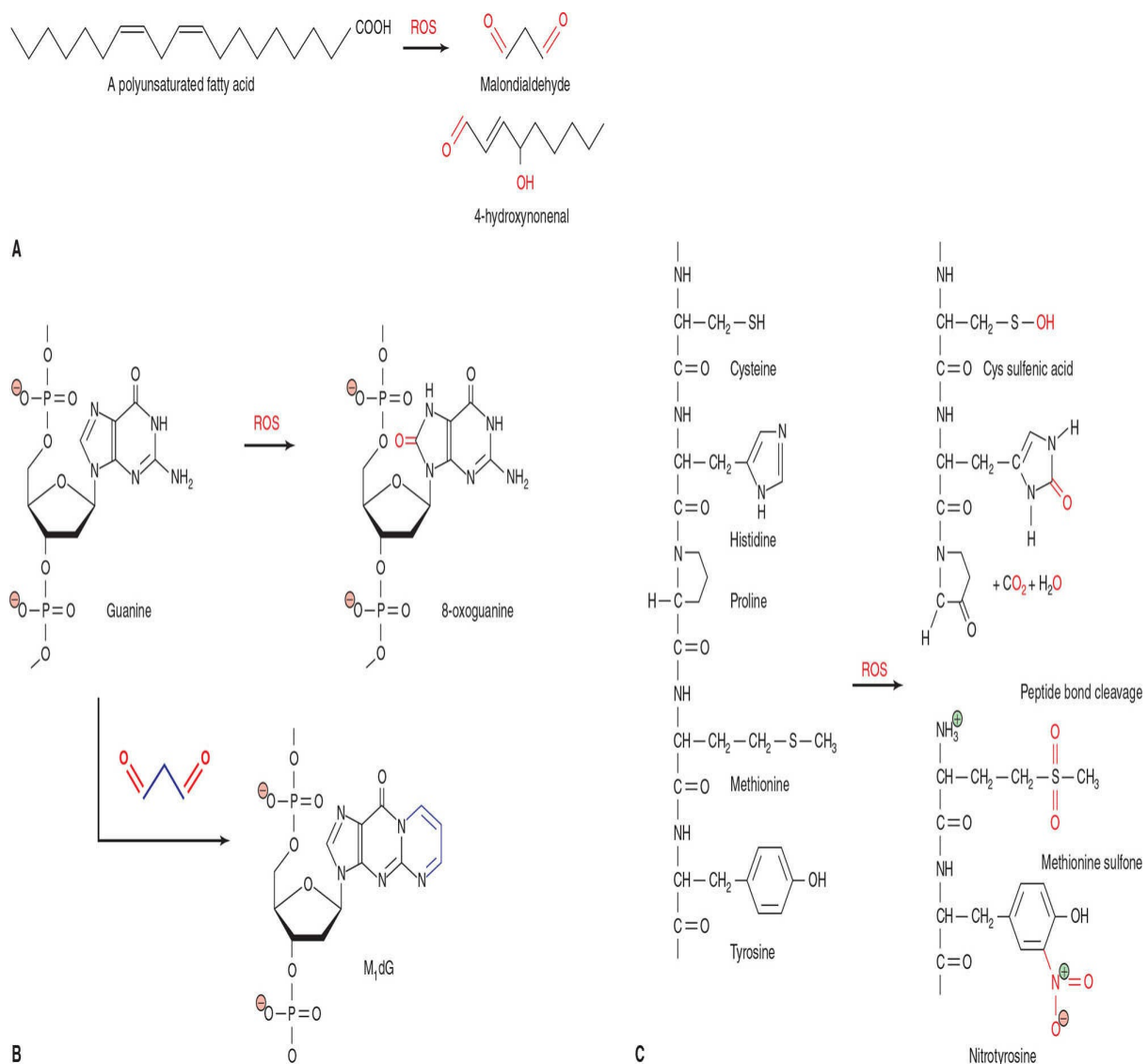

FIGURE 57–3 ROS react directly and indirectly with a wide range of biologic molecules. (A) Peroxidation of unsaturated lipids generates reactive products such as malondialdehyde and 4-hydroxynonenal. (B)

Guanine can be directly oxidized by ROS to produce 8-oxoguanine or form an adduct, M₁dG, with the ROS product malondialdehyde. (C)

Common reactions of proteins with ROS, including oxidation of amino acid side chains and cleavage of peptide bonds. Oxygen atoms derived from ROS are marked in red. Carbon atoms derived from malondialdehyde in M₁dG are colored blue. The complete chemical name for M₁dG is 3-(2-Deoxy-D-*erythro*-pentofuranosyl)pyrimido(1,2- α)purin-10(3*H*)-one.

The ease with which exposure to warm air can turn household butter rancid is a testament to the reactivity of unsaturated fats, those containing one or more carbon–carbon double bonds (see [Chapter 23](#)), with ROS. The resulting peroxidation of lipids can lead to the formation of cross-linked lipid–lipid and lipid-protein adducts that may compromise membrane fluidity and integrity. In mitochondria, a loss of membrane integrity can reduce the efficiency with which the electron transport chain generates ATP and increases leakage of deleterious ROS. Accumulated damage to mitochondrial membranes may eventually lead to the efflux of cytochrome c, an inducer of programmed cell death or **apoptosis** (see below).

Chain Reactions Multiply the Destructiveness of ROS

The destructiveness inherent in the high reactivity of many of ROS, particularly free radicals, is exacerbated by their capacity to participate in chain reactions in which the product of the reaction includes not just a damaged biomolecule, but another free radical species capable of producing more damage and yet another radical by-product. This chain of events will continue until a free radical intermediate is able to pair its radical electron, perhaps by encountering another free radical or a redox protectant such as reduced glutathione. Alternatively, the ROS may be eliminated by one of the cell's suite of dedicated antioxidant enzymes (see [Chapters 12](#) and [53](#)).

The reactivity, and hence destructiveness, of individual ROS varies. Hydrogen peroxide, for example, is less reactive than superoxide, which in turn is less reactive than hydroxyl radical (OH[•]). Two pathways exist by which the highly toxic hydroxyl radical can be generated from less destructive ROS. If ferrous (+2) iron is present, the Fenton reaction can transform hydrogen peroxide into hydroxyl radicals ([Figure 57–2B](#)). The ferric (+3) iron, in turn, can be reduced back to the ferrous (+2) state by other hydrogen peroxide molecules, permitting the iron to act as a catalyst for the production of additional hydroxyl radicals. Hydroxyl radical can

also be generated when superoxide and hydrogen peroxide disproportionate via the Haber-Weiss reaction (Figure 57–2C).

Free Radicals & the Mitochondrial Theory of Aging

In 1956, Denham Harmon proposed the so-called free radical theory of aging. It had been reported that the toxicity of hyperbaric oxygen treatment and radiation could be explained by a factor common to both, the generation of ROS. This report dovetailed nicely with Harmon's own observation that lifespan was inversely related to metabolic rate and, by extrapolation, respiration. He therefore postulated that the cumulative damage was caused by the continual and inescapable production of ROS.

In more recent years, the proponents of the free radical theory of aging have focused attention on the mitochondria. Not only do mitochondria harbor the dominant source of ROS in the cell, the electron transport chain, but oxidative damage to the components of this pathway could lead to increased ROS yields. Damage to the mitochondria also might adversely affect rate efficiency with which they generate ATP, perhaps to the point where it undermines cell vitality and function.

A second contributor to this mitochondrial redox damage cycle is the mitochondrion's indigenous genome. The mitochondrial genome is a much reduced, vestigial remnant of the genome of the ancient bacterium that was the precursor of the current organelle. It is presumed primitive eukaryotes became dependent on surrounding bacteria to provide certain materials, eventually cementing the relationship by **endosymbiosis**, the internalization of the smaller bacterium. Over time most, but not all, of the genes contained in the bacterium's genome were either eliminated or were transferred to the nuclear DNA of the eukaryotic host. Today, the genome of the human mitochondrion encodes two ribosomal RNAs (one for each subunit), 22 tRNAs, several of the polypeptide components of complexes I, III, and IV of the electron transport chain, and parts of F₁, F₀ ATPase (Table 57–3). The mitochondrial genome lacks the surveillance and repair enzymes that help maintain the integrity of nuclear DNA. Hence, deleterious mutations, introduced into the mitochondrially encoded portions of the electron transport chain and their consequent functional defects, become a permanent feature of a mitochondrion's genome to which additional mutations may accrue over time. Under this model, the initial ROS insult serves as the trigger for a self-perpetuating cycle of ROS leakage, DNA damage, and increased ROS leakage.

TABLE 57–3 Genes Encoded by the Genome of Human Mitochondria

rRNA	12S, 16S rRNA
tRNA	22 tRNAs (2 for Leu and Ser)
Subunits of NADH-ubiquinone oxidoreductase (Complex I, >40 total)	ND 1-6, ND 4L
Subunits of ubiquinol-cytochrome c oxidoreductase (Complex III, 11 total)	Cytochrome b
Subunits of cytochrome oxidase (Complex IV, 13 total)	COX I, COX II, COX III
Subunits of the F_1, F_0 ATPase (ATP synthase, 12 total)	ATPase 6, ATPase 8

While the mitochondrial hypothesis is no longer viewed as providing a unifying explanation for all of the changes that are associated with human aging and its comorbidities, this organelle remains a likely contributor. Powerful circumstantial evidence for this is provided by the central role played by this organelle in the sensor-response pathways that trigger apoptosis.

Mitochondria Are Key Participants in Apoptosis

Apoptosis imbues higher organisms with the ability to selectively eliminate cells that are rendered superfluous by developmental changes, such as those that continually take place during embryogenesis, or which have been damaged beyond repair. During developmental tissue remodeling, the apoptotic cell death program is triggered by receptor-mediated signals. In the case of damaged cells, ROS, viral dsRNA, DNA damage, or heat shock may act as triggers. These signals induce the opening of the permeability transition pore complex embedded in the mitochondrial outer membrane, which allows cytochrome c, a small (\approx 12.5 kDa), soluble electron carrier protein, to escape into the cytoplasm. Here, cytochrome c provides the core around which **apoptosome**, a multiprotein complex, coalesces. Assembly of the apoptosome initiates a cascade of proteolytic activation events targeting the proenzyme forms the caspases, a family of cysteine proteases. The terminal caspases, numbers 3 and 7, break down structural proteins in the cytoplasm and chromatin proteins in the nucleus; events that lead to the death and, eventually,

phagocytosis of the morbid cell. Many researchers are working to find ways to exploit the presence of this intrinsic, receptor-mediated cell death pathway as a means for selectively eliminating cancer and other malicious cells.

Ultraviolet Radiation Can Be Extremely Damaging

The term **ultraviolet (UV) radiation** refers to those wavelengths of light that lie immediately below the blue end of the visible spectrum. While the human eye cannot detect them, they are strongly absorbed by organic compounds possessing aromatic rings or multiple, conjugated double bonds. These include the nucleotide bases of DNA and RNA; the side chains of phenylalanine, tyrosine, and tryptophan; polyunsaturated fatty acids; heme groups; and numerous cofactors and coenzymes including flavins, cyanocobalamin, etc. Absorption of this short wavelength, high-energy light can cause the rupture of covalent bonds in proteins, DNA, and RNA; the formation of thymine dimers in DNA (**Figure 57–4**); cross-linking of proteins; and the generation of free radicals. While UV radiation does not penetrate beyond the first few layers of epidermal cells, the high efficiency with which it is absorbed can lead to the rapid accumulation of damage by the skin. Because the nucleotide bases of DNA and RNA are particularly effective at absorbing UV radiation, it is highly mutagenic. Thus, prolonged exposure to intense sunlight can lead to the accumulation of multiple DNA lesions that can overwhelm a cell's intrinsic repair capacity, leading to the development of myelomas—some of which aggressively proliferate if left untreated.

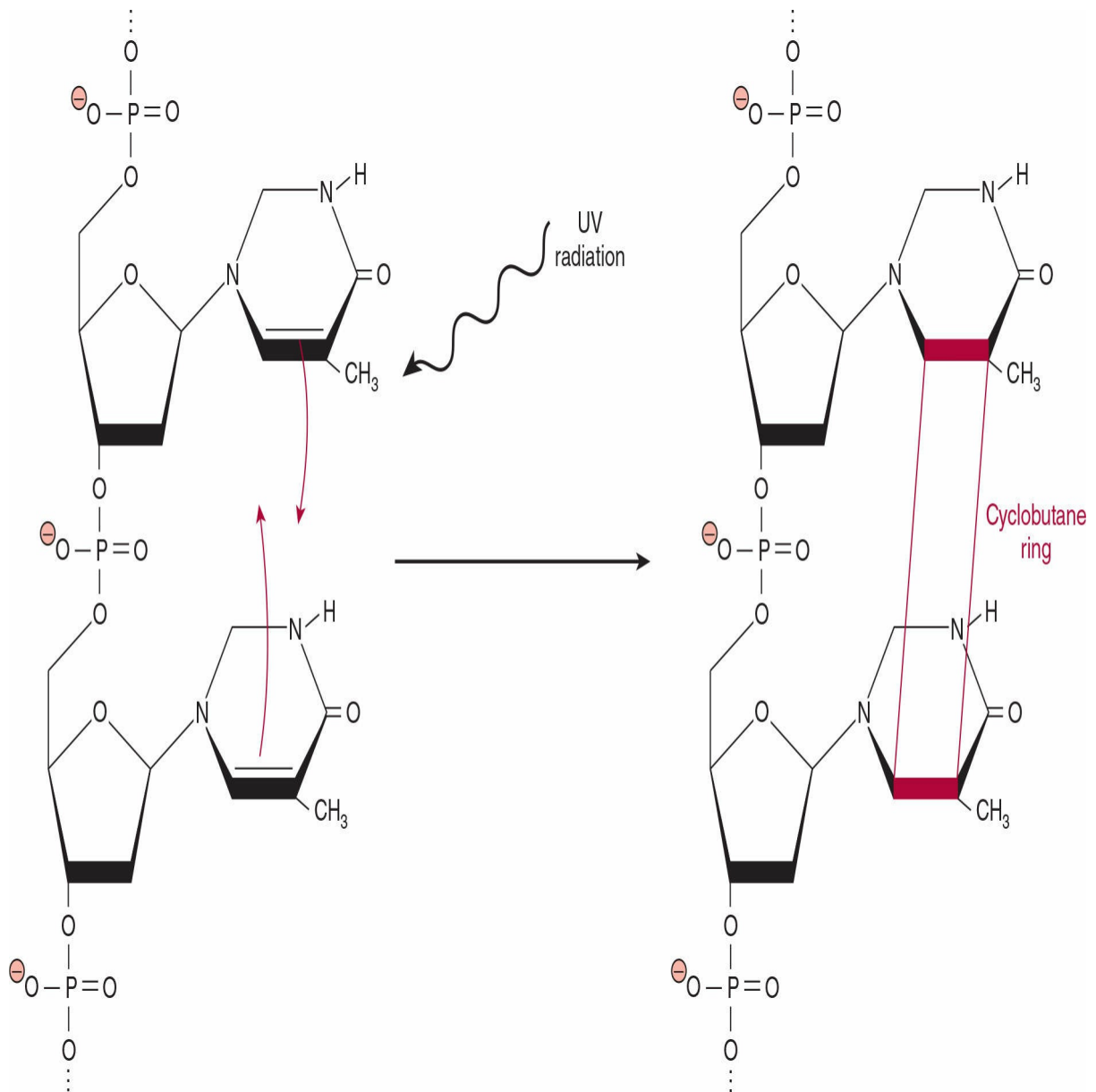

FIGURE 57–4 Formation of a thymine dimer following excitation by UV light. When consecutive thymine bases are stacked one above the other in a DNA double helix, absorption of UV light can lead to the formation of a cyclobutane ring (red, not to scale) covalently linking the two bases together to form a thymine dimer.

Protein Glycation Often Leads to the Formation of Damaging Cross-links

When amine groups in proteins and nucleotides are exposed to a reducing sugar such as glucose, they may form an adduct by a process called **glycation**. The initial step in this process is the formation of a Schiff base between the aldehyde or ketone group of the sugar and the amine. Over

time, the glycated macromolecule undergoes a series of rearrangements to form **Amadori** products, which contain a conjugated carbon–carbon double bond that can react with the amino group on a neighboring protein (**Figure 57–5**). The net result is the formation of a covalent cross-link between two proteins or other biologic macromolecules. These same macromolecules can, in turn, be glycated further, extending the network of cross-links to include other macromolecules. These cross-linked aggregates are sometimes called **advanced glycation end products** or **AGEs**.

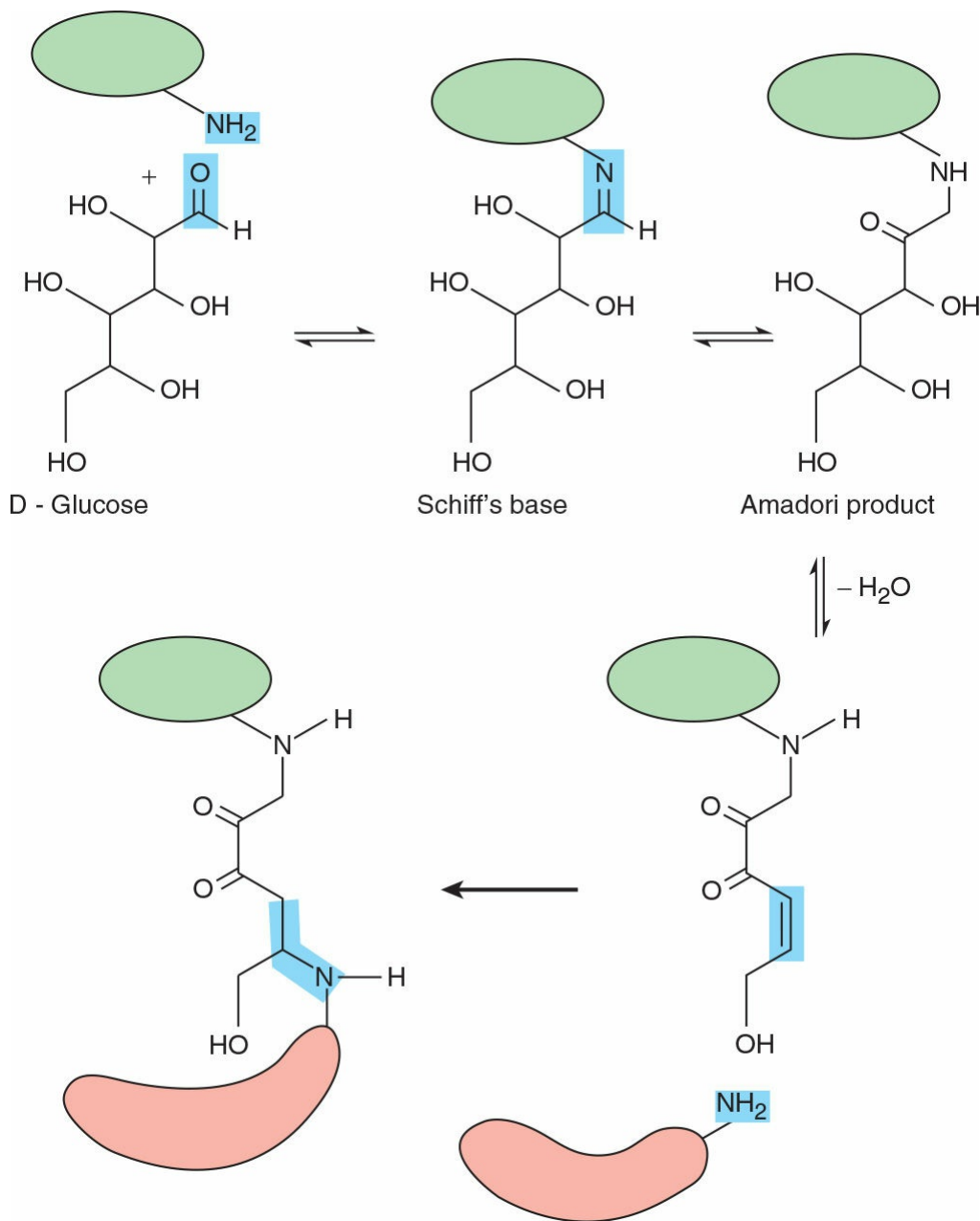

FIGURE 57–5 Protein glycation can lead to the formation of protein–protein cross-links. Shown are the sequence of reactions that generate the

Amadori product on the surface of the protein marked in green, and the subsequent formation of a protein–protein cross-link via an amino group on the surface of a second, red, protein.

The physiologic impact of protein glycation can be especially pronounced when long-lived proteins such as collagen or β -crystallins are affected. Their persistence enhances the opportunity for multiple glycation and subsequent cross-linking events to occur. In vascular endothelial cells, the accumulation of cross-links in the collagen network can lead to the progressive loss of elasticity and thickening of the basement membrane in blood vessels, both of which potentiate plaque formation. The end result is an increasing workload for heart. In the eye, the accumulation of aggregated proteins compromises the opacity of the lens, eventually manifesting itself as cataracts. Diabetics, whose ability to control blood glucose levels is impaired, are particularly susceptible to the formation of AGEs. In fact, the glycation of hemoglobin and serum albumin are used as biomarkers for the diagnosis of diabetes.

MOLECULAR REPAIR MECHANISMS COMBAT WEAR & TEAR

Enzymatic & Chemical Mechanisms Intercept Damaging ROS

A corollary to the wear and tear theory of aging is that longevity reflects the effectiveness and robustness of an individual's molecular prevention, repair, and replacement mechanisms. For example, fruit flies that have been genetically altered to express elevated levels of superoxide dismutase exhibit significantly extended lifespans.

In the cytoplasm, the cysteine-containing tripeptide glutathione acts as a chemical redox protectant that reacts directly with ROS to generate less reactive compounds such as water. Oxidized glutathione, which consists of two tripeptides linked by an S-S bond, is then enzymatically reduced to maintain the pool of protectant (see [Chapter 53](#)). Glutathione can also react directly with cysteine sulfenic acids and disulfides on proteins to restore them to their reduced state, and form adducts with toxic xenobiotics (see [Chapter 47](#)). Ascorbic acid and vitamin E also possess antioxidant properties, which accounts for the popularity of diets that emphasize foods rich in these compounds, or supplementation with them, to combat ROS and, hopefully, slow aging.

The Integrity of DNA is Maintained by Proofreading & Repair Mechanisms

In addition to the prophylactic measures mentioned above, living organisms possess a limited capacity to replace or repair damaged macromolecules. The largest suite of repair enzymes is devoted to maintaining the integrity of the nuclear (but not the mitochondrial) genome. This is to be expected given DNA's pivotal role in inheritance, its vulnerability to chemical assault and UV radiation, and the fact that—by contrast to almost every other macromolecule—each human cell contains only one or two copies of each chromosome.

Maintaining the integrity of the genome begins at replication, where careful proofreading is performed to ensure that the new genome formed during **somatic** cell division faithfully replicates the template that directed its synthesis. The term somatic refers to the differentiated cells that comprise the body of an organism. In addition, most living organisms possess an impressive cadre of enzymes whose role is to inspect and correct aberrations that either escaped replicative proofreading or were subsequently generated through the action of water (double-strand breaks, depurination, and cytosine deamidation), UV radiation (thymine dimers and strand breaks), or exposure to chemical modifiers (adduct formation). This multilayered system is composed of mismatch repair enzymes, nucleotide excision repair enzymes, and base excision repair enzymes as well as the Ku system for repairing double-strand breaks in the phosphodiester backbone (see [Chapter 35](#)). As a last resort, cells harboring damaging mutations are subject to removal by apoptosis.

Despite the many precautions taken to identify and correct errors, some mutations inevitably slip through. Indeed, a low, but finite, frequency of mutation is necessary in order to generate the genetic variability that furthers evolution. The **somatic mutation theory of aging** proposes that these mutations also serves as a driver of the aging process. Simply put, the accumulation of mutated somatic cells must inevitably lead to compromised biologic function that manifests itself, at least in part, as the physical changes we associate with aging.

Some Types of Protein Damage Can Be Repaired

In contrast to DNA, a cell's capacity to repair damage to other biomolecules is relatively limited. For the most part, cells appear to rely on routine turnover, wherein the global population of a given biomolecule is

degraded and replaced by new synthesis on a continuing, or constitutive, basis (see [Chapter 9](#)) to remove damaged lipids, carbohydrates, and proteins. However, some proteins, particularly the fibrous proteins found in tendons, ligaments, bones, matrix, etc, undergo little, if any, turnover. These long-lived proteins tend to accumulate damage over the years, which contributes to the loss of elasticity in vascular tissues and joints, loss of lens opacity, etc. The most prominent mechanisms for repairing damaged proteins target the oxidized side chain sulfur atoms of cysteine and methionine, and the isoaspartyl groups formed when a peptide bond shifts from an α to a side chain carboxyl group.

The side chain sulfhydryl group of cysteine frequently plays important catalytic, regulatory, and structural roles (eg, cysteine disulfides, Fe-S centers) in proteins. However, both the sulfhydryl group of cysteine and the sulfur ether of methionine are extremely vulnerable to oxidation ([Figure 57–3C](#)). Cysteine disulfides, cysteine sulfenic acids, and methionine sulfoxide can be reduced by disulfide reductases and methionine sulfoxide reductases, all of which use NADPH as electron donor, or direct reaction with reduced glutathione. Unfortunately, the reduction potentials of glutathione and NADPH are only sufficient to reduce the lowest oxidation states of these sulfur atoms: cysteine disulfides or sulfenic acids and methionine sulfoxide. Cysteine sulfinic acid, cysteine sulfonic acid, and methionine sulfone are refractory to reduction by available biochemical means.

Aspartic acid possesses the precise geometry needed to bring its side chain carboxyl group into close proximity with the peptide bond involving its α -carboxyl group. The amide nitrogen can react with it to generate a cyclic diamide. This intermediate can reopen to form either the original peptide bond or an isoaspartyl residue in which the side chain carboxyl now forms part of the protein's peptide backbone ([Figure 57–6](#)). The isoaspartyl methyltransferase-catalyzed methylation of the α -carboxyl introduces a leaving group that potentiates the reformation of the cyclic diamide, which can then reopen to form the normal peptide bond linkage ([Figure 57–6](#)).

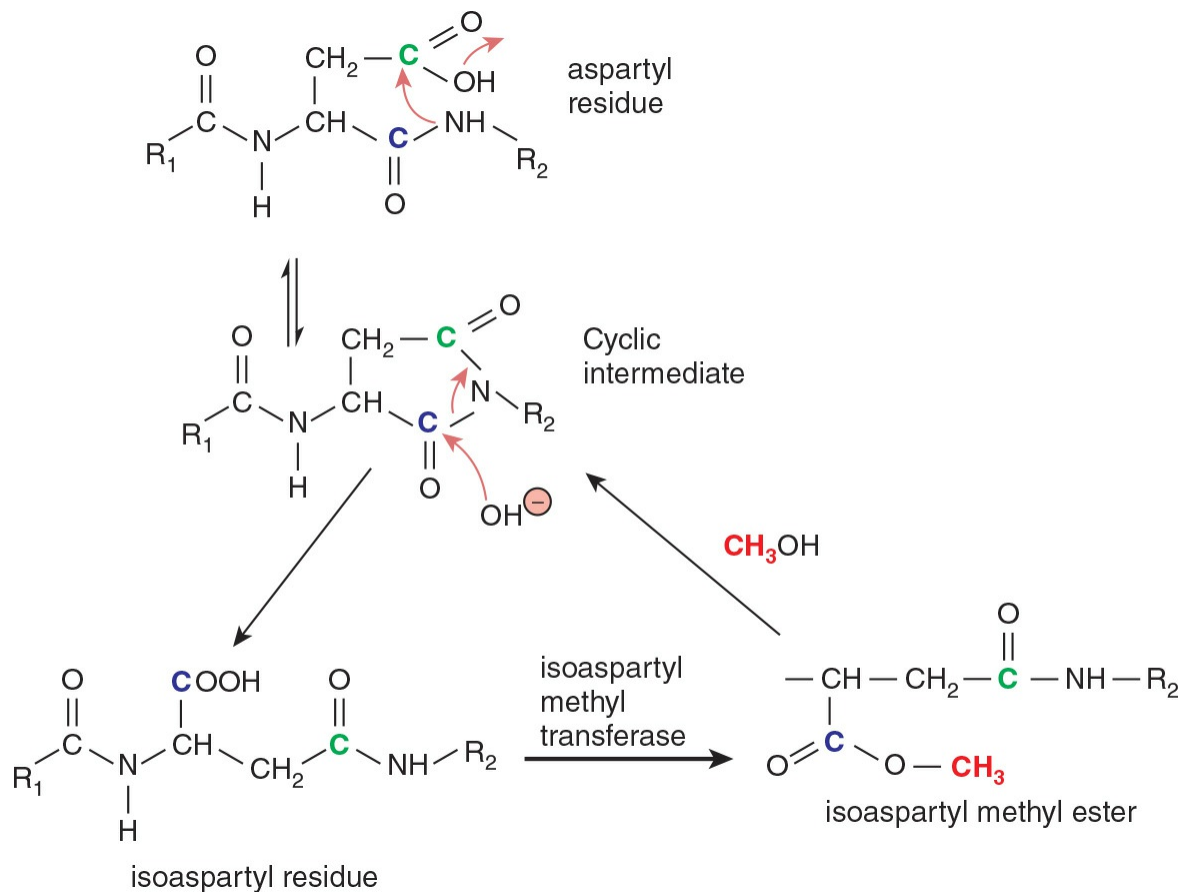

FIGURE 57–6 Formation of an isoaspartyl linkage in a polypeptide backbone and its repair via the intervention of isoaspartyl methyltransferase. Shown is the sequence of chemical and enzyme-catalyzed reactions that lead to formation of an isoaspartyl linkage and restoration of a normal peptide linkage. The carbons corresponding to the α and side chain carboxylic acid groups in aspartic acid are colored blue and green, respectively. Red arrows denote the routes of nucleophilic attack during the cyclization and hydrolysis reactions. The methyl group added by isoaspartyl methyltransferase is colored red.

Aggregated Proteins Are Highly Refractory to Degradation or Repair

Modifications to a protein's composition or conformation that cause it to adhere to other protein molecules can lead to the formation of toxic aggregates, called **amyloid**. Such aggregates are a hallmark of several neurodegenerative diseases, including Parkinson, Alzheimer, Huntington disease, spinocerebellar ataxias, and the transmissible spongiform encephalopathies. The toxic effects of these insoluble aggregates are exacerbated by their persistence, as they are generally refractory to

degradation by the proteases normally responsible for protein turnover.

AGING AS A PREPROGRAMMED PROCESS

While molecular wear and tear undoubtedly contribute to aging, several observations suggest a prominent role for programmed, deterministic mechanisms. Female menopause, for example, provides an unambiguous example of an age-associated physiologic change that is genetically programmed and hormonally controlled. The paragraphs below describe several current theories regarding deterministic, programmed mechanisms for controlling aging and death.

Metabolic Theories of Aging: “The Brighter the Candle, the Quicker It Burns”

One of the many variants of the famous quote attributed to the ancient Chinese philosopher Lao Tzu summarizes the salient features of **metabolic theories of aging**. Its origins can be traced to the observation that the larger members of the animal kingdom tend to live longer than the smaller ones (**Table 57–4**). Reasoning that the causal basis for this correlation derived from in something connected with size, rather than size itself, scientists focused their attention on the organ most frequently associated with life and vitality—the heart. In general, the resting heart rate of small animals such as hummingbirds, 250 beats per minute, tends to be higher than those of large animals such as whales, 10 to 30 beats per minute. Estimates of the total number of times each vertebrate animal’s heart beat over the course of a lifetime exhibited an amazing convergence on 1×10^9 .

TABLE 57–4 Lifespan Versus Body Mass for Several Mammals

Species	Approximate Mass (kg)	Mean Expectation of Life at Maturity (years)
White-footed mouse	0.02	0.28
Deer mouse	0.02	0.43
Bank vole	0.025	0.48
Eastern chipmunk	0.1	1.63
American pika	0.13	2.33
Golden mantled grd. squirrel	0.155	2.12
Red squirrel	0.189	2.45
Belding's ground squirrel	0.25	1.78
Uinta ground squirrel	0.35	1.72
Eastern gray squirrel	0.6	2.17
Arctic ground squirrel	0.7	1.71
Eastern cottontail	1.25	1.48
Striped skunk	2.25	1.90
American badger	7.15	2.33
North Arnerican river otter	7.2	3.79
Bobcat	7.5	2.48
North American beaver	18	1.52
Impala	44	4.80
Bighorn sheep	55	5.48
Wild boar	85	1.91
Warthog	87	2.82
Nilgiri tahr	100	4.71
Blue wildebeest	165	4.79
Red deer stag	175	4.90
Waterbuck	200	5.87
Burchell's zebra	270	7.95
African buffalo	490	4.82
Hippopotamus	2390	16.40
African elephant	4000	19.10

Is the vertebrate heart physically or genetically limited to 1 billion beats? A more nuanced variation of this **heartbeat hypothesis** was put forward by Raymond Pearl in the 1920s. Pearl's **metabolic** or **rate of living hypothesis** posited that an individual's lifespan was reciprocally linked to their basal metabolic rate. It was calculated that every vertebrate animal expends a similar amount of total metabolic energy *per unit body mass*, 7×10^5 J/g, over their lifetime. While intuitively appealing, identification of a mechanistic link between lifespan and energy expenditure or metabolic rate has proven elusive. Adherents of the mitochondrial theory of aging suggest that what is being "counted" is not heartbeats or energy, but the ROS that are the by-product of respiration. Over time, the continued generation of energy and related consumption of O₂ leads to the accumulation of ROS-induced damage to DNA, proteins, and lipids until, eventually, a universally conserved tipping point is reached. Cells experiencing caloric deficits adjust (reprogram) their metabolic pathways to utilize available resources in a more efficient manner that concomitantly decreases the yield of collateral ROS.

Telomeres: A Molecular Countdown Clock?

A second school of thought holds that the putative countdown clock that controls aging and lifespan does not monitor heartbeats, energy, or ROS. Rather, it uses **telomeres** to track the number of times each somatic cell divides.

Unlike the closed circular DNA of bacterial genomes, the genomic DNA of eukaryotes is linear. If left unprotected, the exposed ends of these linear polynucleotides would be available to participate in potentially deleterious genetic recombination events. Telomeres cap the ends of eukaryotic chromosomes with a few hundred GT-rich hexanucleotide repeats. These caps also provide a source dispensable DNA to accommodate the wastage that occurs when linear chromosomes are replicated.

This wastage is a consequence of the fact that all DNA polymerases work unidirectionally, 3' to 5' (see [Chapter 35](#)). When replicating linear double-stranded DNA via discontinuous 3' to 5' synthesis, the 5' end of each new strand will generally commence ≥ 100 bp short of the extreme 5' end of the template strand. Consequently, each time a cell replicates its genome in order to divide, its chromosomes become shorter ([Figure 57–7](#)). The telomeres provide an innocuous source of DNA whose gradual loss

is of little immediate consequence to the cell. However, once the supply of telomere DNA is exhausted, roughly 100 cell divisions for humans, mitosis will cease, causing the somatic cell to enter a state of **replicative senescence**. Hence, as our bodies age, they progressively lose the capacity to replace lost or damaged cells.

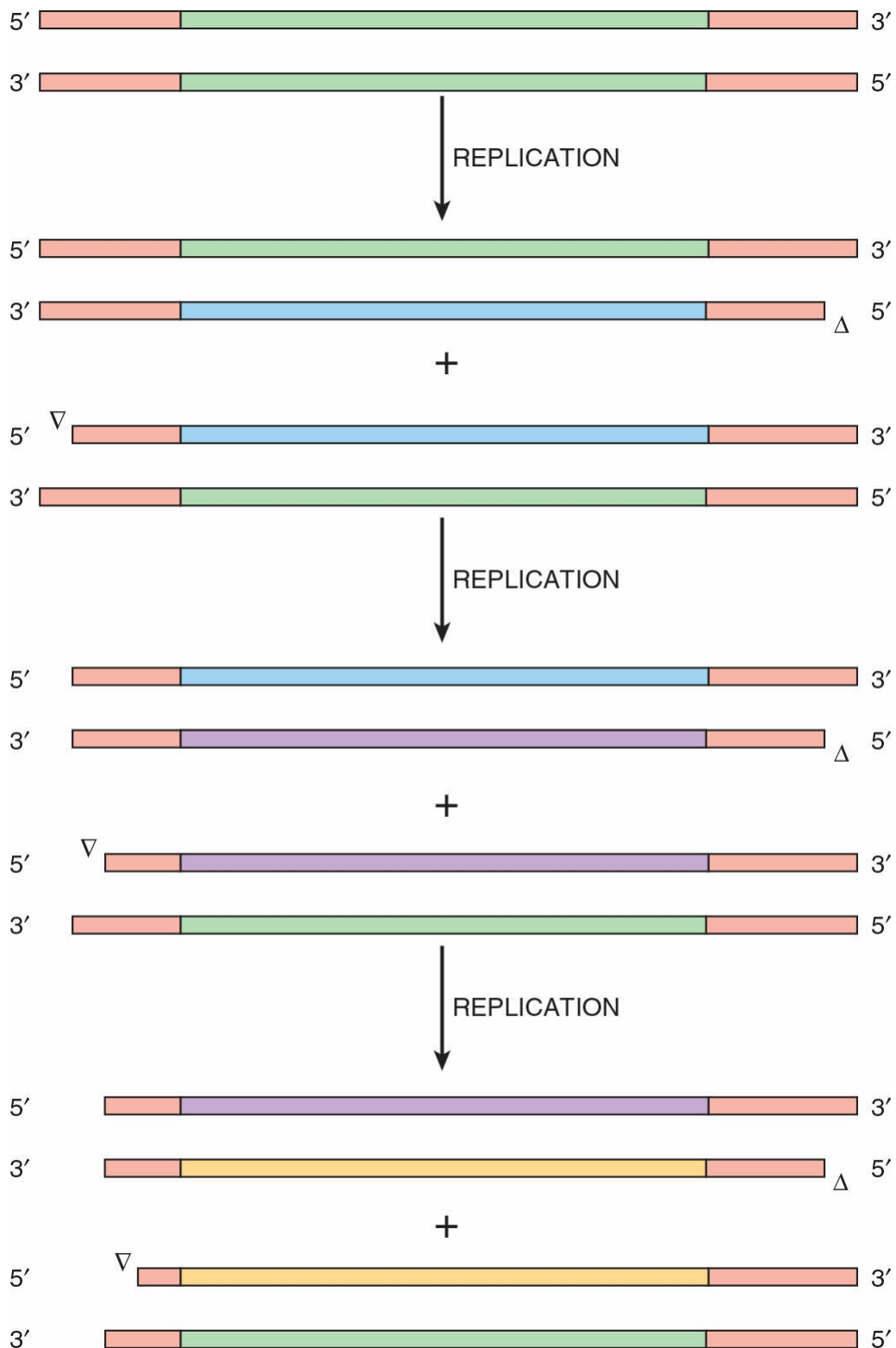

FIGURE 57–7 The telomeres at the ends of eukaryotic chromosomes progressively shorten with each cycle of replication. Shown is a schematic diagram of the linear DNA of a eukaryotic chromosome (green) containing telomeres at each end (red). During the first replication, new DNA strands are synthesized (green) using the original chromosome as template. For simplicity, the next two replication cycles (purple, yellow) show the fate of only the lower of the two nucleotide products from the preceding replicative cycle. Open arrowheads denote the site of incomplete strand synthesis. The model assumes that the single strand overhangs at the ends of each chromosome are trimmed at the completion of each cycle of cell division. Note the progressive shortening of the telomere repeats.

Organisms are able to generate progeny that contain full-length telomeres through the intervention of the enzyme **telomerase**. Telomerase is a ribonucleoprotein that is expressed in stem cells and most cancer cells, but not in somatic cells. Using an RNA template, telomerase adds GT-rich hexanucleotide repeat sequences to the ends of linear DNA molecules that restore their telomeres to full length. In the laboratory, the operation of the proposed telomere clock has been demonstrated by genetically engineered somatic cells to express telomerase. As predicted by the telomere clock hypothesis, the engineered cells continued to divide in culture long after wild-type control cells entered replicative senescence.

Kenyon Used a Model Organism to Discover the First Aging Genes

Many advances in biomedical science are the product of research that uses a variety of so-called model organisms as their test subjects. The fruit fly, *Drosophila melanogaster*, has yielded a rich harvest of information concerning the genes that guide cellular differentiation and organ development. Baker's yeast and the African clawed frog, *Xenopus laevis*, have served as the workhorses for dissecting the signal transduction circuitry that orchestrates the cell division cycle. A variety of cultured mammalian cell lines serve as surrogates for adipocytes, kidney cells, tumors, dendrites, etc. While at first glance it would appear that many of these model systems share little in common with humans, each possesses unique attributes that render them convenient vehicles for addressing particular problems or exploring specific cellular or molecular processes.

Caenorhabditis elegans is a worm that has served as an important subject for the study of developmental biology. *C. elegans* is transparent

and grows rapidly, enabling the developmental program that generates all 959 cells in an adult to be traced back to the fertilized egg. In the early 1990s, Cynthia Kenyon and colleagues observed that worms carrying mutations of the gene encoding an insulin receptor-like molecule, *daf-2*, lived 70% longer than their wild-type counterparts. Equally important, the mutant worms behaved in a manner resembling that of young wild-type *C. elegans* for much of this period. This is an important distinction, as a *bona fide* “aging gene,” must do more than simply prolong existence. It must delay one or more of the physiologic changes associated with aging.

Investigation of further aging genes indicate they code for either one of a small set of transcription factors that include PHA-4 or DAF-16, which presumably control expression of aging critical genes, or signaling proteins such as DAF-2 that probably activate PHA-4, DAF-16, etc, in response to specific environmental signals. Much remains to be learned about the extent to which aging is controlled by genetically programmed events, and how these gene and their products interact with nutritional and other factors that influence vitality and longevity.

WHY WOULD EVOLUTION SELECT FOR LIMITED LIFESPANS?

The idea that animals would have evolved mechanisms designed specifically to limit their lifespan would appear, at first glance, to be counterintuitive. If the driving force behind evolution is the selection for traits that enhance fitness and survival, should not this translate into an ever-increasing life expectancy? However, while extending lifespan may represent a desirable trait from the point of view of the individual, it does not necessarily follow that this applies to a population or species as a whole. A genetically programmed limit on lifespan could benefit the group by eliminating the drain on available resources imposed by members no longer actively involved in the production, development, and training of offspring. Indeed, the current three-generation lifespan can be rationalized as providing time (a) for newborns to develop into reproductively active young adults, (b) for these young adults to produce and nurture their offspring, and (c) for older adults to serve as a source of guidance and assistance to young adults facing the challenges of childbirth and childrearing.

SUMMARY

- Aging and longevity are controlled via the complex interplay between random and deterministic factors that include genetic programming, environmental stresses, lifestyle, cellular countdown clocks, and molecular repair processes.
- Wear and tear theories hypothesize that the aging results from the accumulation of damage over time.
- Water, oxygen, and light are essential for life, but possess an intrinsic capacity to damage biologic macromolecules.
- ROS are continually generated as a by-product of metabolism, particularly the electron transport chain.
- The deleterious effects of ROS are often amplified by free radical chain reactions.
- The reactivity of their unsaturated ring systems and ability to absorb UV light render the nucleotide bases of DNA particularly vulnerable to UV or chemical damage.
- Mutations resulting from errors caused by missing or damaged nucleotide bases can be particularly harmful, and may result in oncogenic transformation.
- Their critical roles in energy production and apoptosis, along with their indigenous genome, render mitochondria a central player in many theories of aging and death.
- Long repeating sequences called telomeres cap the ends of the linear chromosomes in eukaryotes.
- Because telomeres progressively shorten with each division of a somatic cell, they are hypothesized to serve as a countdown clock.
- Model organisms provide useful vehicles for investigating biologic processes.
- Mutation of the *daf-2* gene in *C. elegans* extends the lifespan of worms by 70%.
- Evolutionary selection of a limited lifespan may optimize the vitality of the population rather than that of its individual members.

REFERENCES

- Arias E, Curtin LR, Wei R, et al: U.S. decennial life tables for 1999–2001, United States life tables. *Natl Vital Stat Rep* 2008;57:1.
- Baraibar MA, Friguet B: Oxidative proteome modifications target specific cellular pathways during oxidative stress, cellular senescence and aging. *Exp Gerontol* 2013;48:620.

Bitto A, Wang AM, Bennett CF, Kaeberlein M: Biochemical genetic pathways that modulate aging in multiple species. *Cold Spring Harb Perspect Med* 2015;5.

MacNeil DE, Benoussan HJ, Autexier C: Telomerase regulation from beginning to the end. *Genes (Basel)* 2016;7:64.

Speakman JR: Body size, energy metabolism and lifespan. *J Exp Biol* 2005;208:1717.

Wang Y, Hekimi S: Mitochondrial dysfunction and longevity in animals: untangling the knot. *Science* 2015;350:1204.

Biochemical Case Histories

David A. Bender, PhD

OBJECTIVES

After studying this book, you should be able to:

- Use your knowledge to explain the underlying biochemical defects in diseases.

INTRODUCTION

In this final chapter, nine case histories are presented as open-ended problems for you to solve, based on what you have learnt from studying this book. No solutions are provided, and there is no discussion of the cases; all that you need to know in order to explain the problems is available elsewhere in this book.

In many cases, the patient's clinical chemistry results are presented together with reference ranges. These may differ from problem to problem, because, as discussed in [Chapter 48](#), reference ranges from different laboratories may differ.

CASE 1

The patient is a 5-year-old boy, who was born in 1967, at term, after an uneventful pregnancy. He was a sickly infant, and did not grow well. On a number of occasions his mother noted that he appeared drowsy, or even comatose, and said that there was a “chemical, alcohol-like” smell on his breath, and in his urine. The GP suspected diabetes mellitus, and sent him to the Middlesex Hospital in London for a glucose tolerance test. The results are shown in **Figure 58–1**.

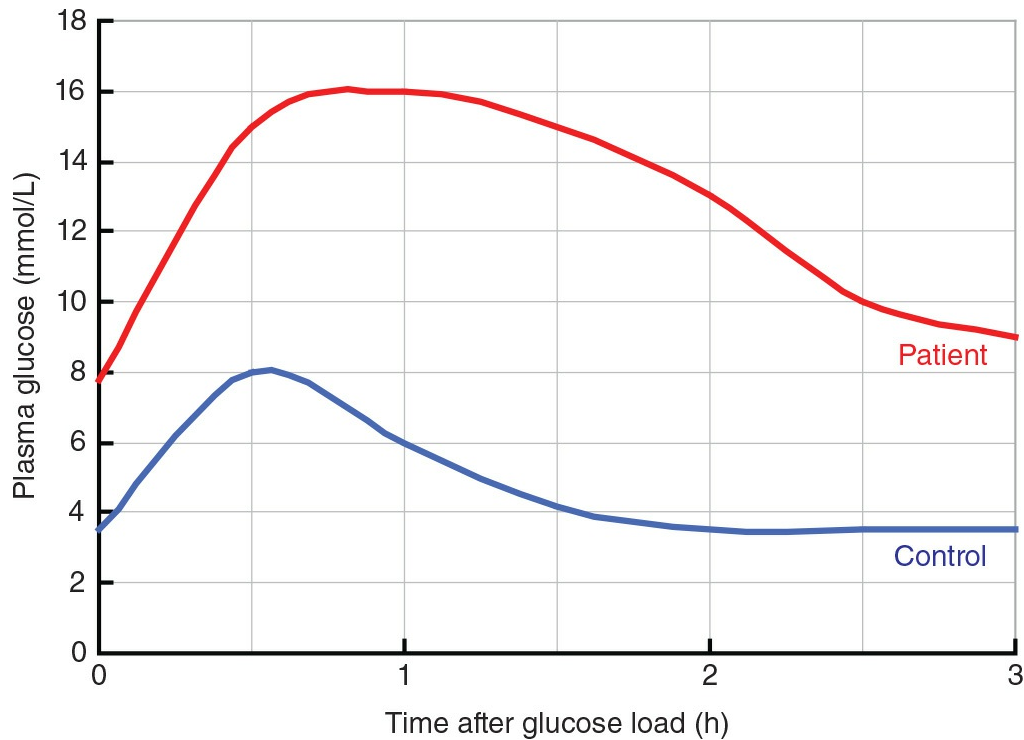

FIGURE 58–1 Plasma glucose in the patient and a control subject after a test dose of glucose.

Blood samples were also taken for measurement of insulin at zero time and 1 hour after the glucose load. At this time, a new method of measuring insulin was being developed, radioimmunoassay (see **Chapter 48**), and therefore both this and the conventional biological assay were used. The biological method of measuring insulin is by its ability to stimulate the uptake and metabolism of glucose in rat muscle *in vitro*; this can be performed relatively simply by measuring the radioactivity in $^{14}\text{CO}_2$ after incubating duplicate samples of the muscle with $[^{14}\text{C}]$ glucose, with and without the sample containing insulin. The results are shown in **Table 58–1**.

TABLE 58–1 Serum Insulin (mU/L) Measured by Biological Assay

and Radioimmunoassay

	Baseline (Fasting) Blood Sample		1 Hour After Glucose Load	
	Patient (Case 1)	Control Subjects	Patient (Case 1)	Control Subjects
Biological assay	0.8	6 ± 2	5	40 ± 11
Radioimmunoassay	10	6 ± 2	50	40 ± 11

As a part of their studies of the new radioimmunoassay for insulin, the team at the Middlesex Hospital performed gel exclusion chromatography of a pooled sample of normal serum, and determined insulin in the fractions eluted from the columns both by radioimmunoassay (graph A in [Figure 58–2](#)) and by stimulation of glucose oxidation (graph B). Three molecular mass markers were used; they eluted as follows: M_r 9000 in fraction 10, M_r 6000 in fraction 23, and M_r 4500 in fraction 27.

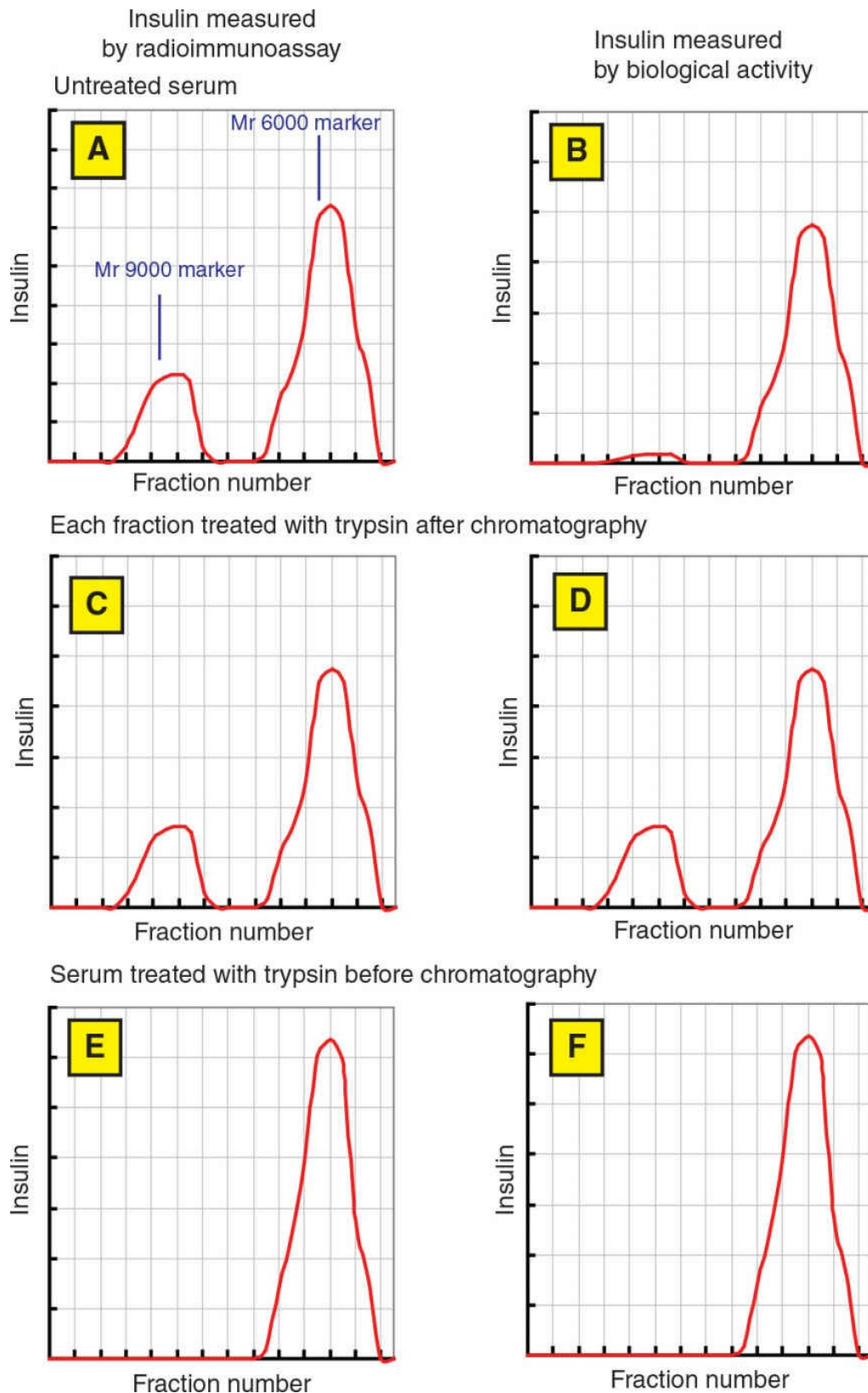

FIGURE 58–2 Insulin measured by radioimmunoassay and biological assay before and after treatment of plasma samples with trypsin.

The investigators also measured insulin in the fractions eluted from the

chromatography column after treatment of each fraction with trypsin. The results are shown in graph C.

After seeing the results of these studies, they subjected the same-pooled serum sample to brief treatment with trypsin, and performed gel exclusion chromatography on the product. Again, they measured insulin by radioimmunoassay (graph D) and biologic assay (graph E).

Since these studies in the 1960s, the gene for human insulin has been cloned. Although insulin consists of two peptide chains, 21- and 30-amino acids long, respectively, these are coded for by a single gene, which has a total of 330 base pairs between the initiator and stop codons. As you would expect for a secreted protein, there is a signal sequence coding for 24 amino acids at the 5' end of the gene.

What does this information suggest about the processes that occur in the synthesis of insulin?

What is likely to be the underlying biochemical basis of the patient's problem?

CASE 2

The patient is a 50-year-old man, 174-cm tall, and weighing 105 kg. He is an engineer, and works on secondment in one of the strict Islamic states in the Gulf, where alcohol is prohibited. At the beginning of August, he returned home for his annual leave. According to his family, he behaved as he usually did when on leave, consuming a great deal of alcohol and refusing meals. He was known to be drinking 2 L of whiskey, two or three bottles of wine, and a dozen or more cans of beer each day; his only solid food consisted of sweets and biscuits.

On September 1st, he was admitted to the emergency department, semiconscious, and with a rapid respiration rate (40/minute). His blood pressure was 90/60 and his pulse rate was 136/minute. His temperature was normal (37.1°C). Emergency blood gas analysis revealed severe acidosis: pH 7.02 and base excess -23; PO₂ 91 mm Hg and PCO₂ 10 mm Hg. He was transferred to intensive care and given intravenous bicarbonate.

His pulse rate remained high, and his blood pressure low, so emergency cardiac catheterization was performed; this revealed a cardiac output of 23 L/min (normal 4-6). A chest x-ray shows significant cardiac enlargement.

Table 58–2 shows the clinical chemistry results from a plasma sample

taken shortly after he was admitted.

TABLE 58–2 Clinical Chemistry Results for the Patient in Case 2 on Admission. All Values Are mmol/L

	Patient in Case 2	Reference Range
Glucose	10.6	3.5-5
Sodium	142	131-151
Potassium	3.9	3.4-5.2
Chloride	91	100-110
Bicarbonate	5	21-29
Lactate	18.9	0.9-2.7
Pyruvate	2.5	0.1-0.2

What is the likely biochemical basis of the patient’s problem, which led to his emergency hospitalization?

What additional test(s) might you request to confirm your assumption?

What emergency treatment would you suggest?

CASE 3

The patient is an African American recruit to the army. He was given the antimalarial drug primaquine, and suffered a delayed reaction with kidney pain, dark urine, and low red blood cell counts that led to anemia and weakness. Centrifugation of a blood sample showed a low hematocrit, and the plasma was red colored.

Similar acute hemolytic attacks have been observed, predominantly in men of Afro-Caribbean origin, in response to primaquine and a variety of other drugs, including dapsone, the antipyretic acetylphenylhydrazine, the antibacterial bactrim/septrin, sulfonamides, and sulfones, whose only common feature is that they all undergo cyclic nonenzymic reactions in the presence of oxygen to produce hydrogen peroxide and a variety of oxygen radicals that can cause oxidative damage to membrane lipids, leading to hemolysis. Moderately severe infection can also precipitate a hemolytic crisis in susceptible people.

One way of screening for sensitivity to primaquine is based on the

observation that the glutathione concentration of erythrocytes from sensitive subjects is somewhat lower than that of control subjects, and falls considerably on incubation with acetylphenylhydrazine.

Glutathione (GSH) is a tripeptide, γ -glutamyl-cysteinyl-glycine, which readily undergoes oxidation to form a disulphide-linked hexapeptide, oxidized glutathione, generally abbreviated to GSSG. **Table 58–3** shows the concentrations of GSH and GSSG in red cells from the patient and 10 control subjects, before and after incubation with acetylphenylhydrazine.

TABLE 58–3 The Effect of Incubation With 330 $\mu\text{mol/L}$ Acetylphenylhydrazine on Erythrocyte Glutathione

	Patient in Case 3		Control Subjects	
	GSH (mmol/L)	GSSG ($\mu\text{mol/L}$)	GSH (mmol/L)	GSSG ($\mu\text{mol/L}$)
Initial	1.61	400	2.01 ± 0.29	4.2 ± 0.61
+ Acetylphenylhydrazine	0.28	1540	1.82 ± 0.24	190 ± 28

How much GSH is oxidized per mol of acetylphenylhydrazine added?

The reported K_m of glutathione reductase for GSSG is 65 $\mu\text{mol/L}$ and for NADPH is 8.5 $\mu\text{mol/L}$. Erythrocyte lysates were incubated with a saturating concentration of GSSG (1 mmol/L) and either NADPH or NADH (100 $\mu\text{mol/L}$). Each incubation contained the hemolysate from 0.5 mL packed cells (**Table 58–4**).

TABLE 58–4 Glutathione Reductase, μmol Product Formed/min

	Patient in Case 3	Control Subjects
NADPH	0.64	0.63 ± 0.06
NADH	0.01	0.01 ± 0.001

Since none of the red cell lysates showed any significant activity with NADH, it is unlikely that there is any transhydrogenase activity in erythrocytes, to reduce NADP^+ to NADPH at the expense of NADH. This raises the problem of the source of NADPH in erythrocytes.

The dye methylene blue will oxidize NADPH; the reduced dye then undergoes nonenzymic oxidation in air, so the addition of a relatively

small amount of methylene blue will effectively deplete NADPH, and would be expected to stimulate any pathway that reduces NADP⁺ to NADPH.

Erythrocytes from control subjects were incubated with 10 mmol/L [¹⁴C]glucose with or without the addition of methylene blue; all six possible positional isomers of [¹⁴C]glucose were used, and the radioactivity in (lactate + pyruvate) was determined after thin layer chromatography of the incubation mixture. Each incubation contained 1 mL of erythrocytes in a total incubation volume of 2 mL (**Table 58–5**).

TABLE 58–5 Production of [¹⁴C]lactate, Pyruvate, and CO₂ by 1 mL Erythrocytes From Control Subjects Incubated for 1 Hour With 10 mmol/L [¹⁴C]glucose at 10 μCi/mmol

	Control		+ Methylene Blue	
	Lactate + Pyruvate	CO ₂	Lactate + Pyruvate	CO ₂
[¹⁴ C-1]glucose	12680 ± 110	1410 ± 15	1830 ± 20	12260 ± 130
[¹⁴ C-2]glucose	14080 ± 120	ND	14120 ± 120	ND
[¹⁴ C-3]glucose	14100 ± 120	ND	14090 ± 120	ND
[¹⁴ C-4]glucose	14060 ± 120	ND	14080 ± 120	ND
[¹⁴ C-5]glucose	14120 ± 120	ND	14060 ± 120	ND
[¹⁴ C-6]glucose	14090 ± 110	ND	14100 ± 120	ND

In further studies, only the formation of ¹⁴CO₂ from [¹⁴C-1]glucose was measured, with the addition of:

- Sodium ascorbate (which undergoes a nonenzymic reaction in air to produce H₂O₂)
- Acetylphenylhydrazine (which is known to precipitate hemolysis in sensitive subjects, and depletes reduced glutathione)
- Methylene blue (which oxidizes NADPH)

The incubations were repeated with *N*-ethylmaleimide, which undergoes a nonenzymic reaction with the —SH group of reduced glutathione, and thus depletes the cell of total glutathione. The results are shown in **Table 58–6**.

TABLE 58–6 Production of $^{14}\text{CO}_2$ by 1 mL Erythrocytes From Control Subjects Incubated for 1 Hour With 10 mmol/L [^{14}C -1]glucose at 10 $\mu\text{Ci}/\text{mmol}$

Additions	Control	+ <i>N</i> -Ethylmaleimide
None	1410 \pm 70	670 \pm 30
Ascorbate	8665 \pm 300	2133 \pm 200
Acetylphenylhydrazine	7740 \pm 320	4955 \pm 325
Methylene blue	12230 \pm 500	11265 \pm 450

Further studies showed that the patient's red blood cells contained only about 20% of the normal activity of glucose-6-phosphate dehydrogenase (see Chapter 20). In order to investigate why his enzyme activity was so low, a sample of his red blood cells was incubated at 45°C for 60 minutes, then cooled to 30°C and the activity of glucose-6-phosphate dehydrogenase was determined. After the preincubation at 45°C, his red cells showed only 60% of their initial activity. By contrast, red cells from control subjects retained 90% of their initial activity after preincubation at 45°C for 60 minutes.

What conclusions can you draw from these results?

CASE 4

The patient is a 10-year-old Maltese boy. On his birthday his aunt gave him a pie made from fava beans (a local delicacy), and that evening he suffered kidney pain, and passed dark urine. A blood film showed a low red blood cell count and the plasma was red colored. This problem is not uncommon in Malta, and indeed several of his classmates (all boys) have died when an acute crisis has been precipitated by eating fava beans, or after a moderate fever associated with an infection.

Further studies showed that his erythrocyte glucose-6-phosphate dehydrogenase was only 10% of normal and had a very high K_m for NADP^+ . Unlike the patient in Case 3, his red blood cell enzyme was as stable to incubation at 45°C as that from control subjects.

What conclusions can you draw from these observations?

CASE 5

The patient is a 28-week-old baby girl. She was admitted to the emergency department in a coma, having suffered a convulsion after feeding. She had a mild infection and slight fever at the time. Since birth she had been a sickly child, and had frequently vomited and become drowsy after feeding. She was bottle-fed and at one time, cows' milk allergy was suspected, although the problems persisted when she was fed on soya milk.

On admission, she was mildly hypoglycemic, ketotic, and her plasma pH was 7.29. Analysis of a blood sample showed normal levels of insulin, but considerable hyperammonemia (plasma ammonium ion concentration 500 $\mu\text{mol/L}$; reference range 40-80 $\mu\text{mol/L}$). She responded well to intravenous glucose infusion and rectal infusion of lactulose, regaining consciousness. She had poor muscle tone.

A liver biopsy sample was taken, and the activities of the enzymes of urea synthesis (see [Chapter 28](#)) were determined, and compared with activities in postmortem liver samples from six infants of the same age. The results are shown in [Table 58–7](#). She remained well on a high-carbohydrate, low-protein diet for several days, although the poor muscle tone and muscle weakness persisted. A second liver biopsy sample was taken after 4 days and the activity of the enzymes determined again.

TABLE 58–7 Activity of Enzymes of the Urea Synthesis Cycle in Liver Biopsy Samples From the Patient in Case 5 on Admission and After 4 Days on a High Carbohydrate, Low-Protein Diet, Compared With Activities in Postmortem Samples From 6 Infants of the Same Age

	$\mu\text{mol Product Formed/min/mg Protein}$		
	Patient		
	On Admission	After 4 Days	Control Subjects
Carbamoyl phosphate synthetase	0.337	1.45	1.30 ± 0.40
Ornithine carbamoyltransferase	29.0	28.6	18.1 ± 4.9
Argininosuccinate synthetase	0.852	0.75	0.49 ± 0.09
Argininosuccinase	1.19	0.95	0.64 ± 0.15
Arginase	183	175	152 ± 56

Her very low-protein diet was continued, but in order to ensure an adequate supply of essential amino acids for growth, she was fed a mixture of the keto acids of threonine, methionine, leucine, isoleucine, and valine. After each feed she again became abnormally drowsy and markedly ketotic, with significant acidosis. Her plasma ammonium ion concentration was within the normal range, and a glucose tolerance test was normal, with a normal increase in insulin secretion after glucose load.

High-pressure liquid chromatography of her plasma revealed an abnormally high concentration of propionic acid ($24 \mu\text{mol/L}$; reference range $0.7\text{--}3 \mu\text{mol/L}$). Urine analysis showed considerable excretion of methylcitrate ($1.1 \mu\text{mol/mg creatinine}$), which is not normally detectable. She was also excreting a significant amount of short-chain acyl carnitine (mainly propionyl carnitine)— $28.6 \mu\text{mol}/24 \text{ hours}$, compared with a reference range of $5.7 + 3.5 \mu\text{mol}/24 \text{ hours}$.

The metabolism of a test dose of [^{13}C]propionate given by intravenous infusion was determined in the patient, her parents, and a group of control subjects; skin fibroblasts were cultured and the activity of propionyl-CoA carboxylase was determined by incubation with propionate and $\text{NaH}^{14}\text{CO}_3$, followed by acidification and measurement of the radioactivity in products. The results are shown in [Table 58–8](#).

TABLE 58–8 Metabolism of [^{13}C]propionate

	Patient in Case 5	Mother	Father	Control Subjects
Percent recovered in $^{13}\text{CO}_2$ over 3 h	1.01	32.6	33.5	65 ± 5
dpm fixed/mg fibroblast protein/30 min	5.0	230	265	561 ± 45

The results of measuring carnitine in the first liver biopsy sample and in a muscle biopsy sample gave the results shown in **Table 58–9**.

TABLE 58–9 Liver and Muscle Carnitine

$\mu\text{mol/g}$ Weight Tissue	Liver		Muscle	
	Patient in Case 5	Control Subjects	Patient in Case 5	Control Subjects
Total carnitine	0.23	0.83 ± 0.26	1.56	2.29 ± 0.75
Free carnitine	0.05	0.41 ± 0.17	0.29	1.62 ± 0.67
Short-chain acylcarnitine	0.16	0.37 ± 0.20	1.16	0.58 ± 0.32
Long-chain acylcarnitine	0.01	0.05 ± 0.02	0.11	0.09 ± 0.03

What conclusions can you draw from these results?

Can you explain the biochemical basis of the patient’s condition?

CASE 6

The patient is a 9-month-old girl, the second child of unrelated parents. She was born at term after an uneventful pregnancy, weighing 3.4 kg and was breast-fed, with gradual introduction of solids from 3 months of age onward. Her mother reported that, while she liked cheese, meat, and fish, she frequently became irritable and grizzly after meals, and became lethargic, drowsy, and “floppy” after eating relatively large amounts of protein-rich foods. Her urine had a curious odor, described by her mother as being “cat-like,” on such occasions.

At 9 months of age she was admitted to the emergency department in a coma, and suffering convulsions. She had been unwell for the last 3 days, with a slight fever, and for the last 12 hours had been refusing all food and

drink. At this time, she weighed 8.8 kg, and her body length was 70.5 cm.

Emergency blood tests revealed moderate acidosis (pH 7.25) and severe hypoglycemia (glucose < 1 mmol/L); a dipstick test for plasma ketone bodies was negative. A blood sample was taken for full clinical chemistry tests, and she was given intravenous glucose. Within a short time, she recovered consciousness. The results of the blood tests are shown in [Table 58–10](#).

TABLE 58–10 Clinical Chemistry Results for a Plasma Sample From the Patient in Case 6 on Admission and Reference Range for 24-Hour Fasting

	Patient in Case 6	Reference Range
Glucose, mmol/L	0.22	4-5
pH	7.25	7.35-7.45
Bicarbonate, mmol/L	11	21-29
Ammonium, μ mol/L	120	<50
Ketone bodies, mmol/L	undetectable	2.5-3.5
Nonesterified fatty acids, mmol/L	2	1.0-1.2
Insulin, mU/L	5	5-35
Glucagon, ng/mL	140	130-160

She remained in hospital for several weeks, while further tests were performed. She was generally well through this time, but became drowsy and severely hypoglycemic, and hyperventilated, if she was deprived of food for more than about 8 to 9 hours. Her muscle tone was poor, and she was very weak, with considerably less strength (eg, in pushing her arms or legs against the pediatrician’s hand) than would be expected for a girl of her age.

On one occasion her blood glucose was monitored at 30-minute intervals over 3 hours from waking, without being fed. It fell from 3.4 mmol/L on waking to 1.3 mmol/L 3 hours later. She was deprived of breakfast again the next day, and again blood glucose was measured at 30-minute intervals for 3 hours during which she received an intravenous infusion of β -hydroxybutyrate (50 μ mol/min/kg body weight). During the infusion of β -hydroxybutyrate, her plasma glucose remained between 3.3

and 3.5 mmol/L.

At no time were ketone bodies detected in her urine, and there was no evidence of any abnormal excretion of amino acids. However, a number of abnormal organic acids were detected in her urine, including relatively large amounts of 3-hydroxy-3-methylglutaric and 3-hydroxy-3-methylglutaconic acids. The excretion of these two acids increased considerably under two conditions:

1. When she was fed a relatively high-protein meal (she became grizzly, lethargic, and irritable). A blood sample taken after such a meal showed significant hyperammonemia (130 μ mol/L), but normal glucose (5.5 mmol/L).
2. When she was fasted for more than the normal overnight fast, with or without the infusion of β -hydroxybutyrate.

One obvious metabolic precursor of 3-hydroxy-3-methylglutaric acid is 3-hydroxy-3-methylglutaryl-CoA (HMG-CoA), which is normally cleaved to yield acetoacetate and acetyl-CoA by the enzyme hydroxymethylglutaryl-CoA lyase (see [Chapter 22](#)). Therefore, the activity of this enzyme was determined in leukocytes from blood samples from the patient and her parents. The results are shown in [Table 58–11](#).

TABLE 58–11 Leukocyte HMG-CoA Lyase Activity, nmol Product Formed/min/g Protein

Patient in Case 6	1.7
Mother	10.2
Father	11.4
Control subjects	19.7 \pm 2.0

Analysis of her urine also revealed considerable excretion of carnitine, as shown in [Table 58–12](#).

TABLE 58–12 Urinary Excretion of Carnitine, nmol/mg Creatinine

	Patient in Case 6	Reference Range
Total carnitine	680	125 \pm 75
Free carnitine	31	51 \pm 40
Acyl carnitine	649	74 \pm 40

What is the likely biochemical basis of the patient’s problem? To what extent can you account for her various metabolic problems from the information you are given?

What dietary manipulation(s) would be likely to maintain her in good health, and prevent further emergency hospital admissions?

CASE 7

The patient is a 9-month-old boy, the second child of unrelated parents; his brother is 5 years old, fit, and healthy. He was born at full term after an uneventful pregnancy, weighing 3.4 kg (the 50th centile), and developed normally until he was 6 months old, after when he showed some retardation of development. He also developed a fine scaly skin rash about this time, and his hair, which had been normal, became thin and sparse.

At 9 months of age, he was admitted to the emergency department in a coma; the results of clinical chemistry tests on a plasma sample are shown in **Table 58–13**.

TABLE 58–13 Clinical Chemistry Results for a Plasma Sample From the Patient in Case 7 on Admission and Reference Range for 24-Hour Fasting

	Patient in Case 7	Reference Range
Glucose, mmol/L	3.3	3.5-5.5
pH	6.9	7.35-7.45
Bicarbonate, mmol/L	2.0	21-25
Ketone bodies, mmol/L	21	1-2.5
Lactate, mmol/L	7-3	0.5-2.2
Pyruvate, mmol/L	0.31	<0.15

The acidosis was treated by intravenous infusion of bicarbonate, and he recovered consciousness. Over the next few days he continued to show signs of acidosis (rapid respiration), and even after a meal ketone bodies were present in his urine. His plasma lactate, pyruvate, and ketone bodies remained high; plasma glucose was in the low normal range, and his plasma insulin was normal both in the fasting state and after an oral

glucose load.

Urine analysis revealed the presence of significant amounts of a number of organic acids that are not normally excreted in the urine, including:

- Lactate, pyruvate, and alanine
- Propionate, hydroxypropionate, and propionyl glycine
- Methylcitrate
- Tiglate and tiglylglycine
- 3-Methyl crotonate, 3-methylcrotonylglycine, and 3-hydroxyisovalerate

His skin rash and hair loss were reminiscent of the signs of biotin deficiency (see [Chapter 44](#)), as caused by excessive consumption of uncooked egg white. However, his mother said that he did not eat raw or undercooked eggs at all, although he was fond of hard-boiled eggs and yeast extract (which are rich sources of biotin). His plasma biotin was 0.2 nmol/L (normal > 0.8 nmol/L), and he excreted a significant amount of biotin in the form of biocytin (see [Figure 44–14](#)) and small biocytin-containing peptides, which are not normally detectable in urine.

He was treated with 5 mg of biotin per day. After 3 days the abnormal organic acids were no longer detectable in his urine, and his plasma lactate, pyruvate, and ketone bodies had returned to normal, although his excretion of biocytin and biocytin-containing peptides increased. At this stage he was discharged from hospital, with a supply of biotin tablets. After 3 weeks his skin rash began to clear, and his hair loss ceased.

Three months later, at a regular out-patient visit, it was decided to cease the biotin supplements. Within a week, the abnormal organic acids were again detected in his urine, and he was treated with varying doses of biotin until the organic aciduria ceased. This was achieved at an intake of 150 µg/d (compared with the reference intake of 10-20 µg/d for an infant under 2 years old).

He has continued to take 150 µg of biotin daily, and has remained in good health for the last 4 years.

Can you account for the biochemical basis of the patient's problem?

CASE 8

The patient is a 4-year-old girl, the only child of nonconsanguineous parents, born at term after an uneventful pregnancy. At 14 months of age she was admitted to hospital with a 1-day history of persistent vomiting,

rapid shallow respiration, and dehydration. On admission, her respiration rate was 60/minute and her pulse 178/minute. The first column in **Table 58–14** shows the results of clinical chemistry tests at that time. She responded rapidly to intravenous bicarbonate and a single intramuscular injection of insulin.

TABLE 58–14 Clinical Chemistry Results for Plasma and Urine Samples From the Patient in Case 8 on Admission and Again 1 Week Later

	Acute Admission	1 Week Later	Reference Range
Plasma			
Glucose, mmol/L	14	5.1	3.5-5.5
Sodium, mmol/L	132	137	135-145
Chloride, mmol/L	111	105	100-106
Bicarbonate, mmol/L	1.5	20	21-25
Urea, mmol/L	4.1	4.9	2.9-8.9
Lactate, mmol/L	7-3	5.5	0.5-2.2
Pyruvate, mmol/L	0.31	0.25	<0.15
Alanine, mmol/L	–	852	99-313
Aspartate, mmol/L	–	Undetectable	3-11
pH	6.89	7-36	7-35–7-45
Urine			
Lactate, mg/g creatinine	–	1.48	<0.1
Ketone bodies, using Ketostix	Very high	Negative	Negative

The results of a glucose tolerance test 3 days after admission were normal, and her plasma insulin response to an oral glucose load was within the normal range. She was discharged from hospital 7 days after admission, apparently fit and well. The second column in **Table 58–14** shows the results of clinical chemistry tests taken shortly before her

discharge.

She was readmitted to hospital at 16, 25, 31, and 48 months of age, suffering from restlessness, unsteady gait, rapid shallow respiration, persistent vomiting, and dehydration. Each time the crisis was preceded by a common childhood illness and decreased appetite, and she responded well to intravenous fluids and bicarbonate. A number of milder episodes were treated at home by oral fluid and bicarbonate.

During her admission at age 25 months, a skin biopsy was taken, fibroblasts were cultured, and the mitochondrial enzyme activities shown in **Table 58–15** were determined.

TABLE 58–15 Activities of Mitochondrial Enzymes From Cultured Skin Fibroblasts (nmol product formed/min/mg protein)

	Patient in Case 8	Control Subjects
Citrate synthase	32.8	76.3 ± 15.1
Cytochrome c reduction by NADH	11.6	16.7 ± 4.6
Cytochrome c reduction by succinate	9.43	12.3 ± 3.2
Cytochrome oxidase	37-7	50.3 ± 11.6
NADH dehydrogenase	633	910 ± 169
Pyruvate carboxylase	0.03	1.62 ± 0.39
Pyruvate dehydrogenase	1.86	1.72 ± 0.35
Succinate oxidase	190	210 ± 30

Can you explain the biochemical basis of the patient's condition?

CASE 9

The patient is a 5-year-old boy who is diabetic. There is a family history of diabetes, which strongly suggests a dominant pattern of inheritance. He secretes a significant amount of insulin, although less than normal subjects, suggesting that the problem is not type 1 diabetes. Unlike type 2 diabetes, this condition develops in early childhood, and is generally referred to as maturity-onset diabetes of the young (MODY).

The results of studies of the secretion of insulin by rabbit pancreas

incubated in vitro with two concentrations of glucose, with and without the addition of the 7-carbon sugar mannoheptulose, which is an inhibitor of the phosphorylation of glucose to glucose-6-phosphate are shown in **Table 58–16**.

TABLE 58–16 Secretion of Insulin ($\mu\text{g}/\text{minute}/\text{incubation}$) by Rabbit Pancreas In Vitro

	Control	+ Mannoheptulose
3.3 mmol/L glucose	3.5	3.5
16.6 mmol/L glucose	12.5	3.5

Two enzymes catalyze the formation of glucose-6-phosphate from glucose (see **Chapter 17**):

- Hexokinase is expressed in all tissues; it has a K_m for glucose of ~ 0.15 mmol/L.
- Glucokinase is expressed only in liver and the β cells of the pancreas; it has a K_m for glucose of ~ 20 mmol/L.

The normal range of plasma glucose is between 3.5 and 5 mmol/L, rising in peripheral blood to 8 to 10 mmol/L after a moderately high intake of glucose. After a meal, the concentration of glucose in the portal blood, coming from the small intestine to the liver, may be considerably higher than this.

What effect will changes in the plasma concentration of glucose have on the rate of formation of glucose-6-phosphate catalyzed by hexokinase?

What effect will changes in the plasma concentration of glucose have on the rate of formation of glucose-6-phosphate catalyzed by glucokinase?

What is the importance of glucokinase in the liver?

Froguel and coworkers (1993) reported studies of the glucokinase gene in a number of families affected by MODY, and also in unaffected families. They published a list of 16 variants of the glucokinase gene, shown in **Table 58–17**. All their patients with MODY had an abnormality of the gene.

TABLE 58–17 Mutations in the Glucokinase Gene

Codon	Nucleotide Change	Amino Acid Change	Effect
4	GAC ⇒ AAC	?	None
10	GCC ⇒ GCT	?	None
70	GAA ⇒ AAA	?	MODY
98	CAG ⇒ TAG	?	MODY
116	ACC ⇒ ACT	?	None
175	GGA ⇒ AGA	?	MODY
182	GTG ⇒ ATG	?	MODY
186	CGA ⇒ TGA	?	MODY
203	GTG ⇒ GCG	?	MODY
228	ACG ⇒ ATG	?	MODY
261	GGG ⇒ AGG	?	MODY
279	GAG ⇒ TAG	?	MODY
300	GAG ⇒ AAG	?	MODY
300	GAG ⇒ CAG	?	MODY
309	CTC ⇒ CCC	?	MODY
414	AAG ⇒ GAG	?	MODY

What are the amino acid changes associated with each mutation in the gene?

Why do the mutations affecting codons 4, 10, and 116 have no effect on the people involved?

What conclusions can you draw from this information?

The same authors also studied the secretion of insulin in response to glucose infusion in patients with MODY and control subjects. They were given an intravenous infusion of glucose; the rate of infusion was varied so as to maintain a constant plasma concentration of glucose of 10 mmol/L. Their plasma concentrations of glucose and insulin were measured before and after 60 minutes of glucose infusion; the results are shown in [Table](#)

58–18.

TABLE 58–18 Plasma Concentrations of Glucose and Insulin Before and After 60 Minutes of Glucose Infusion

	Plasma glucose (mmol/L)		Insulin (mU/L)	
	Patients With MODY	Control Subjects	Patients With MODY	Control Subjects
Fasting	7.0 ± 0.4	5.1 ± 0.3	5 ± 2	6 ± 2
60-min glucose infusion	Maintained at 10 mmol/L by varying rate of infusion		12 ± 7	40 ± 11

What conclusions can you draw from this information about the probable role of glucokinase in the β cells of the pancreas?

Can you deduce the way in which the β cells of the pancreas sense an increase in plasma glucose and signal the secretion of insulin?

Exam Questions

Section XI – Special Topics (C)

1. Which one of the following statements regarding the blood coagulation pathways is NOT CORRECT?
 - A. The components of the extrinsic Xase (tenase) complex are factor VIIa, tissue factor, Ca^{2+} , and factor X.
 - B. The components of the intrinsic Xase (tenase) complex are factors IXa and VIIIa, Ca^{2+} , and factor X.
 - C. The components of the prothrombinase complex are factors Xa and Va, Ca^{2+} , and factor II (prothrombin).
 - D. The extrinsic and intrinsic Xase complexes and prothrombinase complex require anionic procoagulant phosphatidylserine on low-density lipoprotein (LDL) for their assembly.
 - E. Fibrin formed by cleavage of fibrinogen by thrombin is covalently cross-linked by the action of factor XIIIa, which itself is formed

by the action of thrombin on factor XIII.

2. On which one of the following coagulation factors does a patient taking warfarin for his thrombotic disorder have decreased Gla (γ -carboxyglutamate) residues?
 - A. Tissue factor
 - B. Factor XI
 - C. Factor V
 - D. Factor II (prothrombin)
 - E. Fibrinogen

3. A 65-year-old man suffers a myocardial infarction and is given tissue plasminogen activator within 6 hours of onset of the thrombosis to achieve which one of the following?
 - A. Prevent activation of the extrinsic pathway of coagulation
 - B. Inhibit thrombin
 - C. Enhance degradation of factors VIIIa and Va
 - D. Enhance fibrinolysis
 - E. Inhibit platelet aggregation

4. Which one of the following statements regarding platelet activation in hemostasis and thrombosis is NOT CORRECT?
 - A. Platelets adhere directly to subendothelial collagen via GPIa-IIa and GPVI, while binding of GPIb-IX-V is mediated via von Willebrand factor.
 - B. The aggregating agent thromboxane A_2 is formed from arachidonic acid liberated from platelet membrane phospholipids by the action of phospholipase A_2 .
 - C. The aggregating agent ADP is released from the dense granules of activated platelets.
 - D. The aggregating agent thrombin activates intracellular phospholipase $C\beta$, which forms the internal effector molecules 1,2-diacylglycerol and 1,4,5-inositol trisphosphate from the membrane phospholipid phosphatidylinositol 4,5-bisphosphate.
 - E. The ADP receptors, the thromboxane A_2 receptor, the thrombin PAR-1 and PAR-4 receptors, and the fibrinogen GPIIb-IIIa receptor are all examples of G-protein-coupled receptors.

5. A 15-year-old adolescent girl presented at clinic with bruises on her lower extremities. Of the following, which is *least likely* to explain the bleeding signs exhibited by this individual?
- A. Hemophilia A
 - B. von Willebrand disease
 - C. A low platelet count
 - D. Aspirin ingestion
 - E. A platelet disorder with absence of storage granules
6. Regarding chemical carcinogenesis, select the one FALSE statement:
- A. Approximately 80% of human cancers may be due to environmental factors.
 - B. In general, chemical carcinogens interact noncovalently with DNA.
 - C. Some chemicals are converted to carcinogens by enzymes, usually cytochrome P450 species.
 - D. Most ultimate carcinogens are electrophiles and attack nucleophilic groups in DNA.
 - E. The Ames assay is a useful test for screening chemicals for mutagenicity; however, animal testing is required to show that a chemical is carcinogenic.
7. Regarding viral carcinogenesis, select the one FALSE statement:
- A. Approximately 15% of human cancers may be caused by viruses.
 - B. Only RNA viruses are known to be carcinogens.
 - C. RNA viruses causing or associated with tumors include hepatitis C virus.
 - D. Retroviruses possess reverse transcriptase, which copies RNA to DNA.
 - E. Tumor viruses act by deregulating the cell cycle, inhibiting apoptosis, and interfering with normal cell signaling processes.
8. Regarding oncogenes and tumor suppressor genes, select the one FALSE statement:
- A. Both copies of a tumor suppressor gene must be mutated for its product to lose its activity.
 - B. Mutation of an oncogene occurs in somatic cells and is not

- inherited.
- C. The product of an oncogene shows a gain of function that signals cell division.
 - D. *RB* and *P53* are tumor suppressor genes; *MYC* and *RAS* are oncogenes.
 - E. Mutation of one tumor suppressor gene or one oncogene is thought to be sufficient to cause cancer.
9. Regarding growth factors, select the one FALSE statement:
- A. They include a large number of polypeptides, most of which stimulate cell growth.
 - B. Growth factors can act in an endocrine, paracrine, or autocrine manner.
 - C. Certain growth factors, such as TGF- β , can act in a growth inhibitory manner.
 - D. Some receptors for growth factors have tyrosine kinase activity; mutations of these receptors occur in cancer cells.
 - E. PDGF stimulates phospholipase A₂, which hydrolyzes PIP₂ to form DAG and IP₃, both of which are second messengers.
10. Regarding the cell cycle, select the one FALSE statement:
- A. Cells transiting the cell cycle can reside within any of the five phases of the cell cycle (ie, G₁, G₀, S, G₂, and M).
 - B. Cancer cells usually have a shorter generation time than normal cells and there are fewer of them in G₀ phase.
 - C. A variety of mutations in cyclins and CDKs have been reported in cancer cells.
 - D. RB is a cell cycle regulator, where it binds to transcription factor E2F, thus allowing progression of the cell from G₁ to S phase.
 - E. When damage to DNA occurs, p53 increases in amount and activates transcription of genes that delay transit through the cycle.
11. Regarding chromosomes and genomic instability, select the one FALSE statement:
- A. Cancer cells may have a mutator phenotype, which means that they have mutations in genes that affect DNA replication and repair, chromosomal segregation, DNA damage surveillance, and

apoptosis.

- B. Chromosomal instability refers to gain or loss of chromosomes caused by abnormalities of chromosomal segregation during mitosis.
- C. Microsatellite instability involves expansion or contraction of microsatellites due to abnormalities of nucleotide excision repair.
- D. Aneuploidy (when the chromosomal number of a cell is not a multiple of the haploid number) is a common feature of tumor cells.
- E. Abnormalities of chromosome cohesion and of kinetochore-microtubule attachment may contribute to chromosomal instability and aneuploidy.

12. Select the one FALSE statement:

- A. The activity of telomerase is frequently elevated in cancer cells.
- B. A number of cancers have a strong hereditary predisposition or susceptibility; these include Li-Fraumeni syndrome and retinoblastoma.
- C. The products of *BRCA1* and *BRCA2* (responsible for hereditary breast cancer types I and II) appear to be involved in DNA repair.
- D. Tumor cells usually exhibit a high rate of anaerobic glycolysis; this may be at least partly explained by the presence in many tumor cells of the PK-2 isozyme, which is associated with lesser production of ATP and possibly increased use of metabolites to build up biomass.
- E. Dichloroacetate, a compound found to display some anticancer activity, inhibits pyruvate carboxylase, and thus diverts pyruvate away from glycolysis.

13. Select the one FALSE statement:

- A. Whole-genome and exome sequencing is revealing important new information about the numbers and types of mutations in cancer cells.
- B. Abnormalities of epigenetic mechanisms, such as demethylation of cytosine residues, abnormal modification of histones, and aberrant chromatin remodeling are being increasingly detected in cancer cells.
- C. Persistence of cancer stem cells (which are often relatively

dormant and have active DNA repair systems) may help to explain some of the shortcomings of chemotherapy.

- D. Angiogenin is an inhibitor of angiogenesis.
 - E. Chronic inflammation, possibly via increased production of reactive oxygen species, predisposes to development of certain types of cancer.
14. Regarding apoptosis, select the one FALSE statement:
- A. Apoptosis can be initiated by the interaction of certain ligands with specific receptors on cell surface.
 - B. Cell stress and other factors activate the mitochondrial pathway of apoptosis; release of cytochrome P450 into the cytoplasm is an important event in this pathway.
 - C. A distinct pattern of fragments of DNA is found in apoptotic cells; it is caused by caspase-activated DNase.
 - D. Caspase 3 digests cell proteins such as lamin, certain cytoskeletal proteins, and various enzymes, leading to cell death.
 - E. Cancer cells have acquired various mutations that allow them to evade apoptosis, prolonging their existence.
15. Select the one FALSE statement:
- A. Proteins involved in cell adhesion include cadherins, integrins, and selectins.
 - B. Decreased amounts of E-cadherin on the surfaces of cancer cells may help account for the decreased adhesiveness shown by tumor cells.
 - C. Increased activity of GlcNAc transferase V in cancer cells may lead to an altered glycan lattice at the cell surface, perhaps predisposing to their spread.
 - D. Cancer cells secrete metalloproteinases that degrade proteins in the ECM and facilitate their spread.
 - E. All tumor cells have the genetic capacity to colonize.
16. The number of enzymes dedicated to repairing hydrolytic, oxidative, and photochemical damage to polynucleotides such as DNA is much greater than the number devoted to repairing damaged proteins. Identify the statement from the list below that is INCONSISTENT with this observation:

- A. Polynucleotides absorb ultraviolet light more efficiently than do proteins.
 - B. Proteins contain sulfur, an element that is susceptible to oxidation.
 - C. In general, proteins turn over more frequently than does DNA.
 - D. Mutations in a structural gene have the potential to alter the proteins they encode as well as the DNA itself.
 - E. If left uncorrected, genome mutations will be passed on to succeeding generations.
17. Which of the following is NOT a feature of the mitochondrial hypothesis of aging?
- A. Reactive oxygen species are generated as a by-product by the electron transport chain.
 - B. Mitochondria lack the capacity to repair damaged DNA.
 - C. Many of the complexes in the electron transport chain are constructed from a mixture nuclearly encoded and mitochondrially encoded subunits.
 - D. Damaged mitochondria form protease-resistant aggregates.
 - E. Damaged mitochondria can trigger apoptosis—programmed cell death.
18. Which of the following is NOT a component of the cell's suite of damage repair and prevention agents?
- A. Superoxide dismutase
 - B. Glutathione
 - C. Isoaspartyl methyltransferase
 - D. Catalase
 - E. Caspase 7
19. Select the one of the following statements that describes an aspect of the metabolic theory of aging:
- A. Elevated levels of plasma glucose promote the formation of cross-linked protein aggregates.
 - B. Damage from ROS is multiplied by the tendency of oxygen radicals to multiply via chain reactions.
 - C. Calorically restricted diets promote lower and more efficient metabolic activity.

- D. Blood flow to the heart muscle becomes restricted over time due to the cholesterol-induced formation of arterial plaques.
 - E. Vigorous physical activity correlates with the loss of STEM cells.
20. Select the one of the following statements that is NOT CORRECT:
- A. Telomeres prevent genetic recombination by capping the ends of linear DNA molecules.
 - B. Aging genes can be distinguished by their impact on an organism's lifespan.
 - C. The short lifespan of *Caenorhabditis elegans* renders them an attractive model organism for studying aging.
 - D. Telomere shortening is a consequence of the discontinuous nature of the process by which the "lagging strand" is synthesized during chromosome replication.
 - E. Telomerase activity is high in both STEM cells and in many cancer cells.

The Answer Bank

Section I – Proteins: Structure & Function

1. **B.**
2. **D.**
3. That fermentation required intact cells was disproved by the discovery that a cell-free yeast extract could convert sugar to ethanol and carbon dioxide. This discovery led to the identification of the intermediates, enzymes, and cofactors of fermentation and glycolysis.
4. Fermentation ceased over time, but resumed when inorganic orthophosphate was added. This led to the isolation of phosphorylated intermediates. Other experiments using heated yeast extract led to the discovery of ATP, ADP, and NAD.
5. Preparations used to identify metabolites and enzymes included perfused liver, liver slices, and tissue homogenates fractionated by centrifugation.
6. Radioactive ^{14}C , ^3H , and ^{32}P facilitated the isolation of intermediates of carbohydrate, lipid, nucleotide, and amino acid metabolism and enabled precursor product relationships between intermediates to be tracked.
7. Garrod proposal that alkaptonuria, albinism, cystinuria, and pentosuria resulted from “inborn errors of metabolism” led to the field of biochemical genetics.
8. Regulation of cholesterol biosynthesis illustrates the link between biochemistry and genetics. Cell surface receptors internalize plasma cholesterol, which then regulates cholesterol biosynthesis. Defective receptors result in extreme hypercholesterolemia.
9. Key model organisms include yeast, slime mold, fruit fly, and a small round worm, each with a short generation time and readily mutated.
10. **D.** Hydrocarbons are water insoluble.
11. **A.** Of the protein amino acids, only phenylalanine, tyrosine, and tryptophan absorb light at 280 nm.

12. **D.** When present in solution at a pH equal to their pK_a only half of the molecules of a monofunctional weak acid (eg, ammonium ion or acetic acid) are in the charged state. Maximal mobility will occur either at a pH 3 or more pH units below the pK_a for ammonium ion, or at a pH 3 or more pH units above the pK_a for acetic acid.
13. **C.** At its pI an amino acid has an equal number of positive and negative charges, but has no *net* overall charge.
14. **C.** The Edman technique involves successive derivatization and removal of N-terminal residues.
15. Self-association in an aqueous environment as a large droplet minimizes the surface area in contact with water, and hence the number of water molecules whose degrees of rotational freedom are restricted.
16. Strong bases and acids dissociate essentially completely in water, NaOH as Na⁺ and OH⁻. By contrast, a weak acid such as pyruvic acid dissociates only partially in solution.
17. **E.** Tandem mass spectrometry can separate complex mixtures of peptides.
18. **E.** Many proteins undergo posttranslational processing, for example, insulin, which is synthesized as a single polypeptide which subsequent proteolysis converts to two polypeptide chains linked by disulfide bonds.
19. pI is the pH at which a molecule bears no *net* charge. In this example, the pI is a pH midway between the third and fourth pK_a values: pI = (6.3 + 7.7)/2 = 7.0. As pH is adjusted from acidic to basic, net charge will change successively as follows: +3, +2, +1, 0, -1, -2, -3.
20. All of the protein amino acids are *essential* since all are required for protein synthesis, but “nutritionally essential” amino acids (10 for humans) are those which an organism cannot synthesize. Many vitamins are “dietarily essential,” although vitamin C is *dietarily essential* only for humans, catfish, and certain other organisms.
21. **D.** Gene arrays, also termed DNA chips or DNA arrays, contain multiple DNA probes with differing sequences bound at known locations on a solid support. Hybridization of complementary DNA or RNA probes at particular locations provides information about their nucleic acid composition.
22. **D.** A hydrogen bond interaction involves the residue in fourth place along the helix.

23. E. Prions contain no nucleic acid, just protein. Prion diseases therefore are transmitted by protein without involvement of DNA or RNA.
24. Unlike pK_2 (6.82) of phosphoric acid, the other two dissociating groups of phosphoric acid cannot serve as effective buffers at physiologic pH because they are either completely dissociated or predominantly protonated at pH 7.
25. A: Carboxyl groups (pK_1 through pK_3) and amino groups (pK_a through pK_7)
 B: Minus one
 C: Plus 0.5
 D: Toward the cathode
26. To act as an effective buffer, a compound should have a pK_a no less than 0.5 pH units removed from the desired pH, and be present in sufficient quantity.
27. Carboxylation of a glutamyl residue forms γ -carboxyglutamate, a potent chelator of Ca^{++} required for blood clotting and clot dissolution. 4-Hydroxyproline and 5-hydroxylysine are present in several structural proteins.
28. (a) Copper is an essential prosthetic group for the amine oxidase that converts lysine to the hydroxylysine that participates in formation of covalent crosslinks that strengthen collagen.
 (b) Ascorbic acid is essential for proline hydroxylase to convert proline to the hydroxyproline, which provides interchain hydrogen bonds that stabilize the collagen triple helix.
29. Signal sequences target proteins to specific subcellular locations in the cell, or for secretion.

Section II – Enzymes: Kinetics, Mechanism, Regulation, & Role of Transition Metals

1. Carbonic anhydrase catalyzes the hydration of carbon dioxide to form carbonic acid. A portion of this weak acid, in turn, dissociates to produce bicarbonate and a proton. As the concentration of carbon dioxide falls, carbonic acid is broken down form carbon dioxide and water. To compensate for the loss of carbonic acid, bicarbonate and protons recombine to restore equilibrium, leading to a net drop in $[H^+]$ and a rise in pH.
2. D.

3. E.
4. B.
5. A.
6. E.
7. B.
8. C.
9. A.
10. D.
11. E.
12. B.
13. B.
14. C.
15. D.
16. A.
17. B.
18. D.
19. A

Section III – Bioenergetics

1. A. A reaction with a negative ΔG is exergonic, it proceeds spontaneously and free energy is released.
2. E. In an exergonic reaction ΔG is negative and in an endergonic reaction it is positive. When ΔG is zero, the reaction is at equilibrium.
3. B. When the reactants are present in concentrations of 1.0 mol/L, ΔG^0 is the standard free-energy change. For biochemical reaction, the pH (7.0) is also defined and this is $\Delta G^{0'}$.
4. D. ATP contains two high-energy phosphate bonds and is needed to drive endergonic reactions. It is not stored in the body and in the presence of uncouplers its synthesis is blocked.
5. A. Reduced cytochrome c is oxidized by cytochrome c oxidase (complex IV of the respiratory chain), with the concomitant reduction of molecular oxygen to two molecules of water.
6. E. Cytochrome oxidase is not a dehydrogenase, although all other cytochromes are classed as such.
7. B. Although Cytochromes p450 are located mainly in the endoplasmic reticulum, they are found in mitochondria in some tissues.
8. D. Oxidation of one molecule of NADH via the respiratory chain

generates 2.5 molecules of ATP in total. One is formed via complex I, 1 via complex II and 0.5 via complex IV.

9. C. 1.5 molecules of ATP are formed in total as FADH_2 is oxidized, 1 via complex II and 0.5 via complex IV.
10. E. Oligomycin blocks oxidation and ATP synthesis as it prevents the flow of electrons back into the mitochondrial matrix through ATP synthase.
11. A. Uncouplers allow electrons to reenter the mitochondrial matrix without passing through ATP synthase.
12. E. In the presence of an uncoupler, the energy released as electrons flow into the mitochondrial matrix is not captured as ATP and is dissipated as heat.
13. C. Thermogenin is a physiological uncoupler found in brown adipose tissue. Its function is to generate body heat.
14. D. Three ATP molecules are generated for each revolution of the ATP synthase molecule.
15. B. The electrochemical potential difference across the inner mitochondrial membrane caused by electron transport must be negative on the matrix side so that protons are forced to reenter via the ATP synthase to discharge the gradient.

Section IV – Metabolism of Carbohydrates

1. B.
2. B.
3. A.
4. D.
5. C.
6. C.
7. E.
8. B.
9. B.
10. E.
11. C.
12. D.
13. D.
14. D.
15. D.

16. E.
17. E.
18. C.
19. C.
20. C.
21. D.
22. A.
23. B.
24. C.
25. D.
26. E.
27. A.
28. B.

Section V – Metabolism of Lipids

1. D.
2. D.
3. A. Gangliosides are derived from glucosylceramide.
4. C. A, B, D, and E are classed as preventive antioxidants as they act by reducing the rate of chain initiation.
5. D.
6. B.
7. D. Long chain fatty acids are activated by coupling to CoA, but fatty acyl CoA cannot cross the inner mitochondrial membrane. After transfer of the acyl group from CoA to carnitine by carnitine palmitoyl transferase (CPT)-I, acylcarnitine is carried across by carnitine-acylcarnitine translocase in exchange for a carnitine. Inside the matrix, CPT-II transfers the acyl group back to CoA and carnitine is taken back into the intermembrane space by the translocase enzyme.
8. E. The breakdown of palmitic acid (C16) requires 7 cycles of β -oxidation each producing 1 FADH₂ and 1 NADH molecule and results in the formation of eight 2C acetyl CoA molecules.
9. B. When the action of carnitine palmitoyl transferase-I is inhibited by malonyl CoA, fatty acyl groups are unable to enter the matrix of the mitochondria where their breakdown by β -oxidation takes place.
10. C. Humans (and most mammals) do not possess enzymes able to introduce a double bond into fatty acids beyond $\Delta 9$.

11. **D.** Inhibition of the tricarboxylic acid transporter causes levels of citrate in the cytosol to decrease and favors inactivation of the enzyme.
12. **A.**
13. **C.**
14. **E.**
15. **E.** Glucagon is released when blood glucose levels are low. In this situation, fatty acids are broken down for energy and fatty acid synthesis is inhibited.
16. **E.** Glucagon, ACTH, epinephrine and vasopressin promote activation of the enzyme.
17. **B.**
18. **D.**
19. **A.** Chylomicrons are triacylglycerol-rich lipoproteins synthesized in the intestinal mucosa using fat from the diet and secreted into lymph.
20. **E.** VLDL is synthesized and secreted by the liver, and adipose tissue and muscle take up the fatty acids released by the action of lipoprotein lipase.
21. **D.** Very low density lipoprotein secreted by the liver is converted to intermediate density lipoprotein and then to low density lipoprotein (LDL) by the action of lipases and the transfer of cholesterol and proteins from high density lipoprotein. LDL delivers cholesterol to extrahepatic tissues and is also cleared by the liver.
22. **A.** Chylomicrons are synthesized in the intestine and secreted into lymph after a fat meal.
23. **E.** Chylomicrons and their remnants are cleared from the circulation rapidly after a meal, and the secretion of very low density lipoprotein by the liver then increases. Ketone bodies and nonesterified fatty acids are elevated in the fasting state.
24. **C.** When cholesteryl ester is transferred from HDL to other lipoproteins by the action of CETP it is ultimately delivered to the liver in VLDL, IDL, or LDL.
25. **D.** Chylomicrons are metabolized by lipoprotein lipase when bound to the surface of endothelial cells. This process releases fatty acids from triacylglycerol which are then taken up by the tissues. The resulting smaller, cholesterol-enriched chylomicron remnant particles are released into the circulation and cleared by the liver.
26. **C.** Cholesterol is synthesized in the endoplasmic reticulum from acetyl CoA. The rate-limiting step is the formation of mevalonate from

3-hydroxy 3-methylglutaryl-CoA by HMG CoA reductase and lanosterol is the first cyclic intermediate.

27. C.
28. C. Secondary bile acids are produced by the modification of primary bile acids in the intestine.
29. B. If the LDL receptor is defective, LDL is not cleared from the blood, causing severe hypercholesterolemia.
30. A. PCSK9 regulates the re-cycling of LDL receptors to the cell surface after endocytosis has taken place. Inhibition of PCSK9 activity, therefore, increases the number of LDL receptor molecules on the cell surface, leading to an increased rate of clearance and lower blood cholesterol levels.

Section VI – Metabolism of Proteins & Amino Acids

1. D. Phenylalanine hydroxylase catalyzes a functionally irreversible reaction, and thus cannot convert tyrosine to phenylalanine.
2. E. Histamine is a catabolite, not a precursor, of histidine.
3. B. The insertion of selenocysteine into a peptide occurs during, not subsequent to translation.
4. C. Pyridoxal-dependent transamination is the first reaction in degradation of all the common amino acids except threonine, lysine, proline, and hydroxyproline.
5. B. Glutamine.
6. C. The carbon skeleton of alanine contributes the most to hepatic gluconeogenesis.
7. B. ATP and ubiquitin participate in the degradation of nonmembrane-associated proteins and proteins with *short* half-lives.
8. C. Due to the failure to incorporate NH_4^+ into urea, clinical signs of metabolic disorders of the urea cycle include *alkalosis*, not acidosis.
9. E. *Cytosolic* fumarase and *cytosolic* malate dehydrogenase convert fumarate to oxaloacetate following a *cytosolic* reaction of the urea cycle. The *mitochondrial* fumarase and malate dehydrogenase function in the TCA cycle, not urea biosynthesis.
10. A. Serine, not threonine, provides the thioethanol moiety of coenzyme A.
11. E. Decarboxylation of *glutamate*, not *glutamine* forms GABA.
12. 5-Hydroxylysine and γ -carboxyglutamate represent examples of

postranslational modification of peptidyl lysyl and peptidyl glutamyl residues, respectively. By contrast, selenocysteine is incorporated into proteins cotranslationally, in the same way as the other 20 common protein amino acids. The process is complex, and involves the unusual tRNA termed tRNA^{sec}.

13. Biosynthesis of the amino acids that are dietarily essential for humans requires multiple reactions. Since human diets typically contain adequate amounts of these amino acids, loss of the genes that can encode these “unnecessary” enzymes and the lack of need to expend the energy required to copy them provide an evolutionary advantage.
14. Since glutamate dehydrogenase plays multiple central roles in metabolism, its complete absence would unquestionably be fatal.
15. **E.** Albumin is not a hemoprotein. In cases of hemolytic anemia, albumin can bind some metheme, but unlike the other proteins listed, albumin is not a hemoprotein.
16. **A.** Acute intermittent porphyria is due to mutations in the gene for uroporphyrin I synthase.
17. **A.** Bilirubin is a *linear* tetrapyrrole.
18. **D.** The severe jaundice, upper abdominal pain, and weight loss plus the lab results indicating an obstructive type of jaundice are consistent with cancer of the pancreas.
19. The assay takes advantage of the different water solubility of unconjugated and conjugated bilirubin. Two assays are conducted, one in the absence and a second in the presence of an organic solvent, typically methanol. The highly polar glucuronic acid groups of conjugated bilirubin convey water solubility that insures that it will react with the colorimetric reagent even in the absence of any added organic solvent. Data from an assay conducted in the *absence* of added methanol, termed “direct bilirubin,” is bilirubin glucuronide. A second assay conducted in the *presence* of added methanol measures *total* bilirubin, ie, both conjugated and unconjugated bilirubin. The *difference* between total bilirubin and direct bilirubin, reported as “indirect bilirubin,” is *unconjugated* bilirubin.
20. The biosynthesis of heme from succinyl-CoA and glycine occurs only when the availability of free iron signals the potential for synthesis of heme. Regulation targets the first enzyme of the pathway, δ -aminolevulinate synthase (ALA synthase) rather than a subsequent reaction. This conserves energy by avoiding wasting a coenzyme A thioester.

Section VII – Structure, Function, & Replication of Informational Macromolecules

1. **D.** β,γ -Methylene and β,γ -imino purine pyrimidine triphosphates do not readily release the terminal phosphate by hydrolysis or by phosphoryl group transfer.
2. **D.**
3. **E.** Pseudouridine is excreted unchanged in human urine. Its presence there is not indicative of pathology.
4. **A.** Metabolic disorders are infrequently associated with defects in pyrimidine catabolism, which forms water-soluble products.
5. **B.**
6. **D.**
7. **B.**
8. **C.**
9. **C.**
10. **D.**
11. **E.**
12. **B.**
13. **D.**
14. **D.**
15. **E.**
16. **A.**
17. **C.**
18. **B.**
19. **D.**
20. **B.**
21. **C.**
22. **A.**
23. **C.**
24. **A.**
25. **E.**
26. **B.**
27. **A.**
28. **E.**
29. **C.**
30. **A.**
31. **A.**

- 32. C.
- 33. D.
- 34. E.
- 35. C.
- 36. B.
- 37. C.
- 38. E.
- 39. D.
- 40. D.
- 41. B.
- 42. A.
- 43. A.
- 44. E.
- 45. C.
- 46. A.
- 47. C.
- 48. D.
- 49. C.
- 50. B.
- 51. E.
- 52. C.
- 53. D.
- 54. A.
- 55. E.
- 56. A.
- 57. E.
- 58. C.
- 59. A.
- 60. D.
- 61. D.
- 62. E.
- 63. A.
- 64. C.
- 65. C.
- 66. E.
- 67. D.

Section VIII – Biochemistry of Extracellular & Intracellular Communication

1. B. Glycolipids are located on the outer leaflet.
2. A. Alpha-helices are major constituents of membrane proteins.
3. E. Insulin also increases glucose uptake in muscle.
4. A. Its action maintains the high intracellular concentration of potassium compared with sodium.
5. D.
6. B.
7. C.
8. B.
9. D.
10. A.
11. E.
12. B.
13. D.
14. E.
15. B.
16. C.
17. A.
18. C.
19. A.
20. B.
21. D.
22. A.

Section IX – Special Topics (A)

1. A.
2. E.
3. C.
4. D.
5. E.
6. D.
7. C.
8. B.
9. D.

10. E.
11. C.
12. B.
13. C.
14. D.
15. B.
16. A.
17. B.
18. C.
19. E.
20. D.
21. E.
22. A.
23. C.
24. C.
25. A.
26. E.
27. A.
28. A.
29. A.
30. C.
31. E.
32. A.
33. B.
34. A.
35. B.
36. C.
37. D.
38. E.
39. E.
40. A.
41. D.
42. C.
43. B.
44. E.
45. C.
46. B.

- 47. B.
- 48. B.
- 49. B.
- 50. C.
- 51. D.
- 52. C.
- 53. A.
- 54. A.
- 55. A.
- 56. E.
- 57. A.

Section X – Special Topics (B)

1. Within the body, hydrolysis of nitroglycerin releases nitrate ions that can be reduced by mitochondrial aldehyde dehydrogenase to generate nitric oxide (NO), a potent vasodilator.
2. The contractile cycle of cardiac muscle is controlled by oscillations in the level of cytosolic Ca^{2+} . If the reuptake of Ca^{2+} by the sarcoplasmic reticulum is slowed sufficiently by a deficiency SERCA2a activity, cardiac myocytes will be unable to clear this second messenger from their cytoplasm prior to the onset of the next cycle of excitation. The persistence of high basal levels of cytosolic Ca^{2+} will lead to both a reduction in the amplitude of the contractile cycle and the progressive uncoupling of the excitation-contraction cycle.
3. A.
4. A.
5. B.
6. B.
7. E.
8. D.
9. E.
10. Haptoglobin binds extracorporeal hemoglobin, forming a complex that is too large to pass through the glomerulus into kidney tubules.
11. The production of new antibodies with unique antigen-binding properties is reliant on the recombination and mutation of the DNA encoding the hypervariable regions of the immunoglobulin heavy and

light chains. Cytidine deaminase introduces genetic mutations by catalyzing the hydrolysis of cytosine bases present in DNA to uracil.

12. **B.**
13. **C.**
14. **C.**
15. **B.**
16. **E.**
17. **E.**
18. Erythrocytes deficient in glucose-6-phosphate are rendered extremely vulnerable to destruction by reactive oxygen species resulting from a lack of reduced glutathione, an important agent for protecting against oxidative stress. This is a consequence of their reliance on this enzyme to generate a plentiful supply of the NADPH used by glutathione reductase.
19. **E.**
20. **C.**
21. **D.**
22. **A.**
23. **D.**
24. **D.**
25. **B.**
26. **A.**
27. **E.** Importins are involved in the import of proteins into the nucleus.
28. **B.** Some mammalian proteins are known to be translocated posttranslationally.
29. **C.** Ubiquitin tags proteins for degradation by proteasomes.
30. **E.** Furin converts proalbumin to albumin.
31. **C.** NSF is an ATPase.
32. **D.** Cross-links are an important feature of collagen structure.
33. **C.** Deletions in the elastin gene have been identified as responsible for many cases of Williams-Beuren syndrome.
34. **B.** Ehlers-Danlos syndrome subtypes kyphoscoliosis and dermatosparaxis are caused by defects in noncollagen genes.
35. **B.** Hyaluronic acid (hyaluronan) is not sulfated.
36. **C.** Hurler syndrome is caused by a deficiency of α -L-iduronidase.
37. **D.** Achondroplasia is caused by mutations in the *FGFR3* gene.

Section XI – Special Topics (C)

1. **D.**
2. **D.** Of the listed proteins, only factor II is a vitamin K-dependent coagulation factor.
3. **D.**
4. **E.** GPIIb-IIIa (integrin α IIb β 3) is not a G protein–coupled receptor.
5. **A.** Hemophilia A, being an X-chromosome–linked disease, is a very unlikely to occur in a female.
6. **B.** Most chemical carcinogens interact covalently with DNA.
7. **B.** Certain DNA viruses are also known to be carcinogenic.
8. **E.** Mutations in approximately 5 to 6 of these two types of cancer promoting or suppressor genes are thought to be necessary for carcinogenesis.
9. **E.** PDGF stimulates phospholipase C, not phospholipase A.
10. **D.** Binding of RB to E2F blocks progression of the cell from G₁ to S phase.
11. **C.** Microsatellite instability is caused by abnormalities of mismatch repair.
12. **E.** Dichloroacetate inhibits pyruvate dehydrogenase kinase.
13. **D.** Angiogenin is an inhibitor of angiogenesis.
14. **B.** Cytochrome C is released from mitochondria.
15. **E.** Only about 1 in 10,000 cancer may have the capacity to colonize.
16. **B.**
17. **D.**
18. **D.**
19. **C.**
20. **B.**

Index

Please note that index links point to page beginnings from the print edition. Locations are approximate in e-readers, and you may need to page down one or more times after clicking a link to get to the indexed material.

*Note: Page numbers followed by *f* indicate figures; and page numbers followed by *t* indicate tables.*

A

A band, [612](#), [612f](#), [613f](#)

A blood group substances, [653–654](#), [654f](#)

A cyclins, [369](#), [369f](#), [369t](#)

A gene, [653–654](#)

A kinase anchoring proteins (AKAPs), [505](#)

A (acceptor) site, [402](#), [403f](#)

AAV (adenovirus-associated viral) genomes, [437](#)

ABCA1 (ATP-binding cassette transporter A1), [241f](#), [242](#)

ABCG1 (ATP-binding cassette transporter G1), [241f](#), [242](#)

abciximab, [672](#)

abetalipoproteinemia, [239](#), [258t](#)

ABO system, [653–654](#), [654f](#)

absorption

 biomedical importance of, [519](#)

 of carbohydrates, [520](#), [520f](#)

 of lipids, [520–521](#), [522f](#)

 of proteins, [521](#), [523](#)

 of vitamin B₁₂, [101](#), [536](#)

 of vitamins and minerals, [523–524](#), [523f](#)

absorption spectrophotometry, laboratory tests using, 563–564
absorptive pinocytosis, 474*f*, 475
ACAT (acyl-CoA:cholesterol acyltransferase), 253
acceptor arm of tRNA, 346–347, 346*f*, 396, 396*f*
acceptor (A) site, of 80S ribosome, 402, 403*f*
accuracy, of laboratory test, 561, 562*f*
ACE (angiotensin-converting enzyme), 495
aceruloplasminemia, 633
acetic acid, 13*t*, 197*t*
acetoacetate, 207, 210, 211*f*
acetoacetyl-CoA
 in ketogenesis, 211, 212*f*
 in mevalonate synthesis, 250, 250*f*
acetone, 207, 210, 211*f*
acetyl (acyl)-malonyl enzyme, in lipogenesis, 217, 218*f*, 219*f*
acetylation
 enzyme regulation by, 86–89
 of histones, 351, 353*t*
 mass spectrometry detection of, 28*t*
 of xenobiotics, 558–559
acetylcholine, synaptobrevin and, 587
acetyl-CoA
 cholesterol synthesis from, 250, 250*f*, 252*f*
 in citric acid cycle, 150–151, 151*f*, 152*f*, 154–155, 155*f*
 in glycolysis and gluconeogenesis regulation, 175
 in lipogenesis, 217–219, 219*f*, 220*f*, 221
 in metabolic pathways, 130–131, 130*f*, 131*f*, 136
 phenylalanine formation of, 286, 288*f*
 pyruvate oxidation to, 161–163, 162*f*
 threonine conversion to, 285, 285*f*
 tyrosine conversion to, 286, 287*f*
 in VLDL formation, 243, 243*f*
 in xenobiotic metabolism, 559
acetyl-CoA carboxylase
 in lipogenesis, 217, 217*f*, 219*f*, 221–222, 221*f*
 regulation of, 89*t*, 90
N-acetylgalactosamine (GalNAc), 547, 548*t*, 549

N-acetylglucosamine
in glycoproteins, 548t
rapidly reversible glycosylation with, 552–553

N-acetylglutamate
in urea cycle disorders, 277
in urea synthesis, 275f, 276

N-acetylglutamate deacylase, in urea cycle, 276

N-acetylglutamate synthetase (NAGS)
defects in, 277
in urea cycle, 276

N-acetylneuraminic acid (NeuAc), 547, 548t

N-acetylneuraminic acid, in gangliosides, 234, 234f

acetylsalicylic acid. *See* aspirin

acetyltransferases, 89, 559

acholuric jaundice, 313

achondroplasia, 478t, 609

acid anhydride bonds, 320

acid anhydrides, group transfer potential for, 324

acid hydrolases, 475

acid maltase, glycogen hydrolysis by, 166

acid–base balance, ammonia role in, 275

acid–base catalysis, enzymatic, 59–60, 60f

acidic phosphoproteins, 605

acidity, 6

acidosis
ammonia role in, 275
in cancer cells, 696

acids
conjugate, 11
as proton donors, 10
as protonated species, 11
strength of, 13, 13t
strong, 10–11
transition metals as, 93
weak. *See* weak acids

aciduria
dicarboxylic, 215

orotic, 336, 336t

aconitase, in citric acid cycle, 151, 152f

ACP. See acyl carrier protein

acromicric dysplasia, 597

acrosomal reaction, 553

actin, 611

- F-Actin, 613, 614f
- G-Actin, 613, 614f, 623–624
- in muscle contraction, 613–615, 614f, 615f
- in red blood cells, 652t, 653
- striated muscle regulation by, 616

actin filaments, 587, 623–624

actin (thin) filaments, 612–613, 613f, 614f

activated partial thromboplastin time (aPTT, PTT), 679

activated protein C (APC), 677

activation coefficient, 565

activation domains (AD), 381, 427, 428f, 512

activation energy (E_{act}), 69–70, 70f, 72

activation reaction, 501

activation-induced cytidine deaminase, 641

activators

- in gene expression, 410–411
- transcription, 384–385

active chromatin, 353–354, 354f, 418

active site, 58–59, 59f

- activation energy lowering by, 72
- allosteric site compared with, 86

active transport, 467, 467f, 467t

- ATP in, 472–473, 472t
- of bilirubin, 312
- transporters involved in, 468–469, 468f, 468t, 469f

actomyosin, 614

acute coronary syndrome, 654

acute fatty liver of pregnancy, 215

acute inflammatory response, 656

acute intermittent porphyria, 310, 310t, 311f

acute-phase proteins, 526, 630, 630t

acyl carrier protein (ACP), 217, 217f, 218f
 pantothenic acid in, 539, 539f
acyl enzyme, 217, 219f
S-acylation, 463
acylcarnitine, 208, 208f
acyl-CoA
 formation of, 208, 208f
 pyruvate dehydrogenase regulation by, 221
 in triacylglycerol synthesis, 230
acyl-CoA dehydrogenase, 114
 in fatty acid oxidation, 209, 209f
 medium-chain, deficiency of, 215
acyl-CoA synthetase (thiokinase)
 in fatty acid activation, 208, 208f
 mitochondrial compartmentalization of, 118
 in triacylglycerol synthesis, 230, 244, 245f
acyl-CoA:cholesterol acyltransferase (ACAT), 253
acyl-enzyme intermediate, 61, 61f
acylglycerol metabolism
 acylation of triose phosphates, 230, 230f
 biomedical importance of, 229
 ceramide in, 233–234, 233f, 234f
 clinical aspects of, 234–235, 235t
 hydrolysis, 229
 phosphatidate in, 230–232, 231f, 232f
 phospholipases in, 232–233, 233f
1-acylglycerol-3-phosphate acyltransferase, 230, 231f
acylglycerols, 196
 biomedical importance of, 229
 synthesis of, 230–233, 230f, 231f
AD (activation domains), 381, 427, 428f, 512
Ad (adenoviral) genomes, 437
adapter proteins, 475
adaptive immune system, 639, 643, 662
adducts, 710
adenine, 322t
 base pairing in DNA, 339, 340f

- base pairing in RNA, [342](#), [343f](#)
 - salvage pathways of, [332–333](#)
- adenine nucleotide transporter, of mitochondria, [124](#), [124f](#)
- adenocarcinoma, colorectal, [687–688](#), [688f](#), [688t](#)
- adenomatous polyps, colorectal, [687–688](#), [688f](#), [688t](#)
- adenosine
 - in S-adenosylmethionine, [323f](#)
 - derivatives of, [322t](#)
 - syn* and *anti* conformers of, [321f](#)
 - in uric acid formation, [334](#), [335f](#)
- adenosine deaminase
 - deficiency of, [327](#), [335](#), [335f](#), [336t](#), [432](#), [655](#)
 - gene location of, [442t](#)
- adenosine diphosphate (ADP)
 - creatine phosphate shuttle for, [126](#), [126f](#)
 - energy capture and transfer by, [107–108](#), [107t](#), [108f](#), [121–122](#)
 - phosphate cycles of, [109](#), [109f](#)
 - in platelet aggregation, [670](#), [671f](#)
 - respiratory control by, [122–123](#), [123t](#)
 - structure of, [108f](#), [321f](#)
- adenosine monophosphate (AMP), [322t](#), [323f](#)
 - cyclic. *See* cyclic AMP
 - energy capture and transfer by, [107–108](#), [107t](#), [108f](#)
 - IMP conversion to, [328](#), [330f](#)
 - feedback regulation of, [331](#), [331f](#)
 - phosphate cycles of, [109](#), [109f](#)
 - PRPP glutamyl amidotransferase regulated by, [330](#), [331f](#)
 - structure of, [108f](#), [321f](#), [322f](#)
- adenosine triphosphate (ATP)
 - in active transport, [472–473](#), [472f](#)
 - as allosteric effector, [86](#)
 - biomedical importance of, [105](#)
 - as cellular energy currency, [108–110](#), [108f](#), [109f](#), [121–122](#)
 - citric acid cycle generation of, [151](#), [151f](#), [153](#)
 - control of supply of, [122–123](#), [123t](#)
 - in coupling of endergonic and exergonic reactions, [109](#)
 - creatine phosphate shuttle for, [126](#), [126f](#)

energy capture and transfer by, 107–108, 107t, 108f, 121–122
erythrocyte generation of, 648, 648t
fatty acid oxidation production of, 209–210, 209f, 210t
free energy of hydrolysis of, 107–108, 107t, 108f
in glycolysis and gluconeogenesis regulation, 176, 176f
glycolysis production of, 157, 158f, 159, 159f, 161, 161f
in muscle contraction, 614–616, 615f, 620–621, 621f
oxidative phosphorylation in synthesis of, 118, 121–122, 122f
phosphate cycles of, 109, 109f
protein degradation dependent on, 270–271, 270f, 271f
in purine synthesis, 328
structure of, 107f, 108f, 321f
as transducer of free energy, 322
S-adenosylmethionine, 323, 323f, 324t
 biosynthesis of, 288, 290f, 291f, 298–299, 299f
adenoviral (Ad) genomes, 437
adenovirus-associated viral (AAV) genomes, 437
adenylyl cyclase, 167, 168f, 169f
 cAMP intracellular signal and, 503–504, 503t
 in lipolysis, 246, 246f
adenylyl kinase (myokinase), 109, 176
 mitochondrial compartmentalization of, 118
 in muscle contraction, 621
adherens junctions, 466
adhesion, glycoprotein role in, 553–554
adipocytes, 247
 turnover of, 708t
adipokines, 244
adiponectin, 244
adipose tissue, 196, 229
 brown, 247, 247f
 in fasting state, 130, 138–139, 138t, 139f, 139t
 in fed state, 130, 136–138, 137f, 138t
 glucose uptake by, 136–137, 137f
 glucose utilization by, 245
 hormones and lipolysis in, 246, 246f
 insulin and, 245

- lipase, [244–245](#), [245f](#)
- lipogenesis and, [247](#)
- perilipin in, [247](#)
- triacylglycerol storage in, [244](#)

ADP. *See* adenosine diphosphate

ADPase, in hemostasis and thrombosis, [672](#)

ADP-chaperone complex, [575](#)

ADP-ribosylation

- enzyme regulation by, [86–87](#)
- of histones, [351](#), [353t](#)
- NAD⁺ as source for, [534](#)

ADP-ribosylation factor-1 (ARF-1), [242](#), [243f](#)

adrenal function tests, [567](#)

adrenal gland, cytochromes P450 in, [557](#)

adrenal steroidogenesis

- androgen synthesis, [486f](#), [487](#)
- glucocorticoid synthesis, [486–487](#), [486f](#)
- mineralocorticoid synthesis, [485–486](#), [486f](#)
- overview of, [485](#), [485f](#)

adrenergic receptors, glycogenolysis activation by, [168](#), [169f](#)

adrenocortical hormone, cholesterol as precursor for, [202](#)

adrenogenital syndrome, [487](#)

adrenoleukodystrophy, neonatal, [580](#), [580t](#)

advanced glycation end-products (AGEs), [553](#), [553f](#), [712–713](#)

aerobic conditions, [157](#), [158t](#), [160](#), [620](#)

aerobic processes, [151](#)

affinity chromatography

- protein and peptide purification with, [25–26](#)
- recombinant fusion protein purification with, [65–66](#), [66f](#)

agammaglobulinemia, [645](#)

AGEs (advanced glycation end-products), [553](#), [553f](#), [712–713](#)

aggrecan, [608](#), [608t](#), [609f](#)

aggregated proteins, toxic effects of, [715](#)

aggregates, protein, [41](#)

aggregating agents, in platelet aggregation, [670](#), [671f](#)

aggregation prevention, [581](#)

aging

biomedical importance of, 707
cancer and, 698
extracellular matrix and, 592
metabolic theories of, 715–716, 716t
mortality and, 708
as preprogrammed process, 715–717
proteoglycans and, 604
somatic mutation theory of, 714
telomerase and, 355
wear and tear theories of. *See* wear and tear theories of aging

aging genes
model organisms of, 716–717
transcription factors, 717

aglycone, 145

AHSP (α -hemoglobin-stabilizing protein), 42

AIDS
glycan role in, 555
undernutrition in, 525

AKAPs (A kinase anchoring proteins), 505

ALA. *See* δ -aminolevulinate; α -linolenic acid

alanine, 15t
carbon skeleton catabolism of, 283
circulating plasma levels of, 271–272, 271f, 272f
metabolic pathways of, 138
specialized products of, 296–297
synthesis of, 265, 265f
transamination reactions forming, 272–273, 273f

β -alanine, biosynthesis of, 302–303

alanine aminotransferase (ALT)
diagnostic use of, 64, 64t, 566
transamination reaction of, 273, 273f

β -alanyl dipeptides, biosynthesis of, 303

albumin, 599, 627, 628, 630, 631
bilirubin binding to, 311, 315
free fatty acids in combination with, 208, 236, 237t, 238
synthesis of, 588, 588f

albuminuria, 599

alcohol dehydrogenase in fatty liver, 244
alcoholic liver disease (ALD), 244
alcoholism
 case study, 720
 cirrhosis and, 244
 transferrin glycosylation in, 633
alcohols
 carbohydrates as aldehyde or ketone derivatives of, 141–142, 142t
 energy yields from, 138t
 hydrogen bonding of, 7, 7f
 iron absorption and, 523–524
 sulfation of, 558
ALD (alcoholic liver disease), 244
aldehyde dehydrogenase, 112
 in fatty liver, 244
aldehyde oxidase, molybdenum in, 100
aldolase
 deficiency of, 163
 in glycolysis, 159, 159f
aldolase B, 186, 188f
 deficiency of, 190
aldose reductase, 191
aldose-ketose isomerism, 143, 144f
aldoses, 141–142, 142t, 143, 144f
aldosterone synthase, 485–486
alimentary pentosuria, 189
Alisporivir, 42
alkaline phosphatase, 64t, 605
alkalosis, ammonia effects on, 275
alkaptonuria, 286, 287f
alkylphospholipid, 229
allergic reactions, to foods, 519, 523
allopurinol, 324, 324f, 334, 336
allosteric effectors, 85–86, 85f, 136, 175
allosteric properties, of hemoglobin, 50–53, 50f, 51f, 52f, 53f
allosteric regulation
 of enzymes, 85–86, 85f, 135–136, 135f

- in glycolysis and gluconeogenesis regulation, 175
- allosteric site, 85–86
- alpha-anomers, 143
- α helix
 - in myoglobin, 48, 48*f*
 - as secondary structure unit, 35–36, 35*f*, 37*f*
- Alport syndrome, 595–596, 595*t*
- ALT. *See* alanine aminotransferase
- alteplase, 679
- alternative pathway, 644
- alternative polyadenylation, 430
- alternative transcription start site, 430
- altitude, physiologic adaptations to, 53
- Alu family, 358, 360
- Alzheimer disease
 - ω 3 fatty acids and, 199
 - pathologic protein conformations in, 42
 - respiratory chain disorders in, 126
- Amadori products, 712
- ambiguity and genetic code, 394
- Ames assay, 684, 684*f*
- amino acid oxidases, 112, 273–274, 274*f*
- amino acids
 - hydrolysis of peptide bonds, 708–709, 709*f*
 - missense mutations and, 396–397, 397*f*
 - nonsense codons and, 397, 398*f*
 - transporter/carrier systems for, 468
 - tRNA association with, 395–396, 395*f*, 396*f*
- D-amino acids, free, 18
- D- α -amino acids, biomedical importance of, 14
- L- α -amino acids
 - absorption of, 521, 523
 - biomedical importance of, 14
 - biosynthetic conversions of
 - alanine, 296–297
 - arginine, 297, 297*f*, 301, 302*f*
 - biomedical importance of, 296

cysteine, [297](#), [297f](#)
glycine, [298](#), [298f](#), [300–301](#), [302f](#)
histidine, [298](#), [298f](#)
methionine, [298–299](#), [299f](#), [300f](#), [301](#), [302f](#)
phosphoserine, phosphothreonine, and phosphotyrosine, [300](#)
serine, [300](#)
tryptophan, [300](#), [301f](#)
tyrosine, [300](#), [302f](#)

catabolism of

- alanine, [283](#)
- amino acid oxidases in, [273–274](#), [274f](#)
- ammonia from, [269](#), [272–275](#), [274f](#)
- arginine and ornithine, [282](#), [283f](#)
- asparagine and aspartate, [281–282](#)
- biomedical importance of, [269](#), [280–281](#)
- to carbohydrate and lipid biosynthesis intermediates, [281](#), [281f](#), [281t](#)
- carbon skeleton fates in, [281](#), [281f](#), [281t](#)
- cystine and cysteine, [283–285](#), [284f](#)
- disorders of, [276–278](#), [277t](#)
- end products of, [272](#), [275](#), [275f](#)
- glutamate dehydrogenase in, [273](#), [274f](#)
- glutaminase and asparaginase in, [274](#), [274f](#)
- glutamine and glutamate, [282](#)
- glutamine synthetase in, [274](#), [274f](#)
- glycine, [282–283](#), [284f](#)
- histidine, [282](#), [283f](#)
- hydroxyproline, [285–286](#), [285f](#)
- initiation of, [281](#)
- isoleucine, leucine, and valine, [288](#), [290](#), [292f](#), [293](#), [293f](#), [293t](#)
- lysine, [286](#), [288f](#)
- metabolic diseases of, [280–281](#), [293](#), [294t](#)
- methionine, [288](#), [290f](#), [291f](#)
- phenylalanine, [286](#), [288f](#)
- proline, [282](#), [282f](#)
- rate of, [269–270](#)
- serine, [283](#), [284f](#)
- threonine, [285](#), [285f](#)

- transamination reactions in, [272–273](#), [273f](#), [281](#)
- tryptophan, [286–288](#), [289f](#), [290f](#)
- tyrosine, [286](#), [287f](#)
- urea synthesis in, [272–273](#), [272f](#), [273f](#), [275–276](#), [275f](#)
- chemical reactions of, [20](#)
- circulating plasma levels of, [271–272](#), [271f](#), [272f](#)
- conservation of catalytic, [61](#)
- deamination of, [133](#)
- deficiency of, [263–264](#)
- determination of sequences of
 - Edman reaction for, [27–28](#), [27f](#)
 - genomics and, [28](#)
 - mass spectrometry for, [28–30](#), [28t](#), [29f](#), [30f](#)
 - molecular biology techniques for, [28](#)
 - proteomics and, [30–31](#)
 - purification techniques for, [23–26](#), [25f](#), [26f](#), [27f](#)
 - Sanger’s work in, [26–27](#)
- essential, [14](#), [131](#), [264](#), [264t](#), [526](#)
- extraterrestrial, [17–18](#)
- functional groups of, [18–20](#), [19f](#), [20f](#), [20t](#)
- genetic code specification of, [15](#), [15t–16t](#), [17t](#), [394](#), [394t](#)
- glucogenic, [136](#), [272](#), [272f](#)
- glucose derived from, [177](#)
- for health maintenance, [3](#)
- hydrophobic and hydrophilic, [17t](#)
- ketogenic, [136](#)
- as metabolic fuel, [130](#), [136](#)
- metabolic pathways of, [130–131](#), [130f](#), [131f](#)
 - in fasting state, [138](#), [138t](#)
 - in fed state, [137f](#), [138](#), [138t](#)
 - at tissue and organ levels, [132–133](#), [132f](#), [133f](#)
- metabolic roles of, [18](#)
- net charge of, [18–19](#), [19f](#)
- nonessential, [131](#), [264](#), [264t](#), [526](#)
- nutritional requirements for, [525–526](#)
- peptide bonds between, [20](#)
- pI of, [19](#)

pK_a of, 19–20, 20*t*
pK_a values of, 15*t*–16*t*
post-translational modifications of, 15, 17, 17*f*
properties of, 15–18, 15*t*–16*t*, 17*f*, 17*t*, 18*t*
protease and peptidase generation of, 270–271, 270*f*, 271*f*
protein and peptide primary structures and, 20–21
selenocysteine as 21st, 15, 17, 17*f*
solubility of, 20, 20*f*
stereochemistry of, 17
synthesis of
 alanine and aspartate, 265, 265*f*
 asparagine, 265, 266*f*
 biomedical importance of, 263–264
 citric acid cycle role in, 153–154, 154*f*
 cysteine, 265, 267*f*
 glutamate, 264–265, 265*f*
 glutamine, 265, 265*f*
 glycine, 265, 266*f*
 hydroxyproline and hydroxylysine, 266, 268*f*
 lengthy pathways of, 264, 264*t*
 proline, 265, 267*f*
 selenocysteine, 267–268, 268*f*
 serine, 265, 266*f*
 tyrosine, 266, 267*f*
 valine, leucine, and isoleucine, 266–267
toxic plant, 18, 18*t*
ultraviolet light absorption by, 20, 20*f*
unusual, 21, 21*f*
β-amino acids, biosynthetic conversions of
 alanine and aminoisobutyrate, 302–303
 alanyl dipeptides, 303
 GABA, 303, 303*f*
amino sugars, 145, 145*f*
 synthesis of, 188, 190*f*
aminoacyl residues, 21
aminoacyl site, aminoacyl-tRNA binding to, 402, 403*f*
aminoacyl-tRNA in protein synthesis, 395, 395*f*, 402, 403*f*

aminoacyl-tRNA synthetases, 395, 395f
aminoadipate- δ -semialdehyde synthase, 286, 288f
 γ -aminobutyrate (GABA), biosynthesis of, 303, 303f
 β -aminoisobutyrate, biosynthesis of, 302–303
 δ -aminolevulinate (ALA)
 heavy metal inactivation of, 94
 synthesis of, 306, 306f, 309f
 δ -aminolevulinate (ALA) dehydratase, 306, 307f, 309f, 310t
 δ -aminolevulinate (ALA) synthase, 306–308, 306f, 309f, 310t
aminopeptidases, 521
aminophospholipids, membrane asymmetry and, 464
aminopyrine, uronic acid pathway effects of, 189
aminotransferases, 154, 265, 265f
 diagnostic use of, 64, 64t, 566
 transamination reactions of, 272–273, 273f, 281
 vitamin B₆ in, 273, 273f, 535
ammonia
 from amino acid degradation, 269, 272–275, 274f
 citric acid cycle and, 150, 156
 intoxication with, 273–274
 nitrogen excretion as, 272
 in urea cycle disorders, 276–278, 277t
ammonium ion, pK_a of, 13t
ammonotelic animals, 272
amobarbital, 118, 123
AMP. *See* adenosine monophosphate
AMP-activated protein kinase, 90
AMP-activated protein kinase (AMPK), 253, 253f
amphibolic pathways, 129
 citric acid cycle as, 153, 154f
amphipathic helices, 36
amphipathic lipids
 in lipoproteins, 237–238, 238f
 in membranes, 204–205, 205f, 461–462, 461f
amphipathic molecules, 8
ampicillin (Amp) resistance genes, 437

AMPK (AMP-activated protein kinase), 253, 253f
AMPK kinase (AMPKK), 253, 253f
amplification
 in cancer, 685
 in fibrin clot formation, 677
amylase
 diagnostic use of, 64t
 starch hydrolysis by, 520
amyloid, 715
 β -amyloid, in Alzheimer disease, 42
amyloidosis, 639, 639t
amylopectin, 145, 147f
amylose, 145, 147f
anabolic pathways, 129
anabolism, 106
anaerobic conditions, glycolysis in, 157, 158f, 158t, 160, 696, 697f
analbuminemia, 630
analytes, 561
anaphylaxis, slow-reacting substance of, 227
anaplerotic substrates, 153–154
androgens
 steroidogenesis
 ovarian, 487–489, 489f, 490f
 testicular, 487, 488f
 synthesis of, 486f, 487
androstenedione, 487, 488f
anemias, 54
 causes of, 646, 650t
 definition, 646
 Diamond-Blackfan, 649
 hemolytic. *See* hemolytic anemias
 of inflammation, 635
 iron deficiency, 636, 637t, 650t
 megaloblastic, 538, 650t
 pernicious, 536–537
aneuploidy, in cancer, 691–692, 692f
ANF (atrial natriuretic factor), 482, 483t

angiogenesis, in cancer, 696–698
angiotensin II, 495–496, 496f
angiotensin-converting enzyme (ACE), 495
angiotensin-converting enzyme inhibitors, 495
angiotensinogen, 495, 496f
anion exchange protein, 652
ankyrin, 652t, 653
anomeric carbon atom, 143
anserine, 298, 298f, 303
antennae, of glycoproteins, 550
anterior pituitary gland, hormones of, 179
anterograde transport (COPII), 586, 587f
anterograde vesicular transport, 583
anti conformers, 320–321, 321f
antibiotics
 amino acids in, 14
 amino sugars in, 145
 bacterial protein synthesis and, 406–407, 407f
 folate metabolism inhibitors as, 537
 glycosides, 145
 resistance to, 80, 98, 99f
antibodies, 627. *See also* immunoglobulins
 monoclonal, 642–643
anticancer agents. *See* chemotherapy
anticoagulant drugs, mechanism of, 677–678
anticodon region of tRNA, 394–396, 396f
antifolate drugs, purine nucleotide synthesis affected by, 328, 330
antigenicity, xenobiotic alteration of, 559
anti-Lepore, 359, 360f
antimalarial drugs, folate metabolism inhibitors as, 537
antimycin A, 123
antioxidants, 116
 biomedical importance of, 541
 classes of, 204
 pro-oxidant paradox of, 544–545, 544t
 protective mechanisms of, 543–544, 544f
 vitamin E as, 532

antiparallel loops, mRNA and tRNA, 396
antiparallel strands, DNA, 339, 340*f*
antiparallel β sheet, 36, 36*f*
antiplatelet drugs, 672
antiport systems, 468, 468*f*
antiporter systems, for sugar nucleotides in glycoprotein synthesis, 549–550
 α_1 -antiproteinase, 638
antiproteinase inhibitor, 662
antiproteinases, 662
antipyrine, uronic acid pathway effects of, 189
antithrombin, 627, 630*t*, 677
 α_1 -antitrypsin, 662, 677
APC (activated protein C), 677
apo A-I, 237*t*, 238
 alcohol consumption and, 257
 deficiencies of, 258*t*
 in HDL metabolism, 241*f*, 242
apo A-II, 237*t*, 238, 240
apo A-IV, 237*t*, 238
apo B-48, 237*t*, 238
apo B-100, 237*t*, 238
 in LDL metabolism, 240*f*, 241
 regulation of, 253
apo B-100 receptor
 in LDL metabolism, 241
 regulation of, 253
apo C-I, 237*t*, 238
apo C-II, 237*t*, 238, 240
apo C-III, 237*t*, 238, 240
apo D, 237*t*, 238
apo E, 237*t*, 238, 241
apo E receptor
 in chylomicron remnant uptake, 240*f*, 241
 in LDL metabolism, 241
 regulation of, 253
apolipoprotein E, in Alzheimer disease, 42

apolipoproteins/apoproteins, distribution of, [237t](#), [238](#)
apomyoglobin, [49](#), [49f](#)
apoptosis, [710](#)
 cancer evasion of, [681–682](#), [692–694](#), [693f](#), [694t](#)
 cardiolipin in, [230](#)
 ceramide in, [233](#)
 DNA damage and, [371–372](#), [371f](#)
 phosphatidylcholines in, [200](#)
apoptosome, [694](#), [712](#)
apoptotic cell death program, [712](#)
aprotic acids, [93](#)
aPTT. *See* activated partial thromboplastin time
aquaporins, [472](#)
aqueous solutions. *See* water
arabinose, [144f](#), [144t](#)
arachidonic acid/arachidonate, [197t](#), [199f](#)
 eicosanoid formation and, [224](#), [225f](#), [226f](#), [227f](#)
 for essential fatty acid deficiency, [224](#)
 nutritionally essential, [222–223](#), [222f](#)
ARF-1 (ADP-ribosylation factor-1), [242](#), [243f](#)
arginase
 defects in, [278](#)
 in urea synthesis, [275f](#), [276](#)
arginine, [16t](#)
 carbon skeleton catabolism of, [282](#), [283f](#)
 resonance hybrids of, [18–19](#), [19f](#)
 specialized products of, [297](#), [297f](#), [301](#), [302f](#)
 in urea synthesis, [275f](#), [276](#)
arginine phosphate, in energy conservation and capture, [108](#)
argininosuccinate, in urea synthesis, [275–276](#), [275f](#)
argininosuccinate lyase
 defects in, [277t](#), [278](#)
 in urea synthesis, [275f](#), [276](#)
argininosuccinate synthetase
 defects in, [277t](#), [278](#)
 in urea synthesis, [275f](#), [276](#)
Argonaute proteins, [391](#)

aromatase enzyme complex, 487–489, 489f
ARS (autonomously replicating sequences), 362
arsenic
 in glycolysis pathway, 159
 toxicity of, 93–94
arsenite, 153
arthritis. *See also* osteoarthritis
 gouty, 334, 336t
 proteoglycans in, 604
 rheumatoid. *See* rheumatoid arthritis
artificial membranes, 465
arylamines, sulfation of, 558
ascorbate, 186
ascorbic acid. *See* vitamin C
asialoglycoprotein receptors, 547, 582–583, 582f
asialoglycoproteins, 475
a-SNAP, 586t, 588
asparaginase, in amino acid catabolism, 274, 274f, 281–282
asparagine, 16t
 carbon skeleton catabolism of, 281–282
 deamination of, 274, 274f
 synthesis of, 265, 266f
asparagine synthetase, 265, 266f
asparagine–*N*-acetylglucosamine linkage, in glycoproteins, 548f, 550, 550f
aspartate
 carbon skeleton catabolism of, 281–282
 in citric acid cycle, 153, 154f
 synthesis of, 265, 265f
 in urea synthesis, 275f, 276
aspartate aminotransferase (AST), diagnostic use of, 64, 566
aspartate transcarbamoylase (ATCase), 86
 in pyrimidine synthesis, 333f
aspartic acid, 16t
 pH effects on, 19, 19f
aspartic proteases, acid–base catalysis of, 60, 60f
aspirin (acetylsalicylic acid)
 antiplatelet effects of, 672

- cancer development and, [700](#), [703](#)
- cyclooxygenase affected by, [226](#)
- prostaglandin synthesis affected by, [216](#)

assembly particles, [475](#)

AST (aspartate aminotransferase), diagnostic use of, [64](#), [566](#)

asthma, leukotrienes in, [198](#)

asymmetry

- inside-outside, [464](#)
- of lipid and proteins in membrane assembly, [589](#), [589f](#)
- of membranes, [464](#)
- Ran molecules and, [578](#)

ataxia-telangiectasia, mutated (ATM), [371](#), [371f](#)

ATCase (aspartate transcarbamoylase), [86](#)

- in pyrimidine synthesis, [333f](#)

atherosclerosis

- advanced glycation end-products in, [553](#)
- cholesterol and, [202](#), [250](#), [256–257](#)
- folic acid supplements for, [538](#)
- free radical damage causing, [542](#)
- HDL and, [242](#), [257](#)
- LDL plasma concentration and, [241](#), [257](#)
- lipids and, [196](#), [198](#)
- lysophosphatidylcholine and, [201](#)
- premature, [237](#), [241](#)
- trans fatty acids and, [226](#)

ATM (ataxia-telangiectasia, mutated), [371](#), [371f](#)

ATM-related kinase (ATR), [371](#), [371f](#)

atomic absorption spectrometry, [564](#)

atorvastatin, [257](#)

ATP. *See* adenosine triphosphate

ATP synthase

- mitochondrial compartmentalization of, [118](#)
- rotary motor function of, [121](#), [122f](#)

ATP/ADP cycle, [108](#), [108f](#)

ATPase, [472–473](#), [472f](#)

- chaperones exhibiting activity of, [574](#)
- in osteoclasts, [605](#)

ATP-binding cassette transporter A1 (ABCA1), [241f](#), [242](#)
ATP-binding cassette transporter G1 (ABCG1), [241f](#), [242](#)
ATP-chaperone complex, [575](#)
ATP-citrate lyase, in lipogenesis, [218](#), [219f](#)
ATP-driven active transporters, [472](#), [473t](#)
ATR (ATM-related kinase), [371](#), [371f](#)
atractyloside, [123](#), [124f](#)
atrial natriuretic factor (ANF), [482](#), [483t](#)
autoantibodies, [641](#)
autocrine signaling, [662](#)
autoimmune disease
 free radical damage causing, [542](#)
 xenobiotic role in, [559](#)
autoimmune disorder, [627](#), [628t](#)
autoimmune response, [645](#)
autoimmunity, [641](#)
autonomously replicating sequences (ARS), [362](#)
autotrophic organisms, [107](#)
avian influenza virus, glycans in binding of, [555](#)
axial ratios, [34](#)
axonemal dyneins, [625](#)
5- or 6-azacytidine, [324](#)
5-azadeoxycytidine, [690](#)
8-azaguanine, [324](#), [324f](#)
azaserine, [328](#), [329f](#)
azathioprine, [325](#), [325f](#)
5- or 6-azauridine, [324](#), [324f](#), [336](#)

B

B blood group substances, [653–654](#), [654f](#)
B cyclins, [369](#), [369f](#), [369t](#)
B form of DNA, [340](#), [340f](#)
B gene, [653–654](#)
B lymphocytes, [639](#), [662](#)
BAC (bacterial artificial chromosome) vector, [436–437](#), [437t](#)
bacitracin, [14](#)
bacteria

antibiotic and protein synthesis in, 406–407, 407f
bilirubin reduction by intestinal, 313
glycans in binding of, 555
transcription cycle in, 377, 377f
transcription in, 379–380, 380f
bacterial artificial chromosome (BAC) vector, 436–437, 437t
bacterial DNA-dependent RNA polymerase, 377, 377f
bacterial lox P sites, 435
bacterial plasmids, 436, 436f
bacterial promoters, in transcription, 379, 380f
bacteriophage lambda
 as paradigm for protein-DNA interactions, 414–418, 414f, 415f, 416f, 417f
 at sites of, 435
balanced chemical equations, 69
BamHI, 433, 433t, 434f
BAPN (γ -glutamyl- β -aminopropionitrile), 18, 18t
barbital, uronic acid pathway effects of, 189
barbiturates, respiratory chain inhibition by, 118, 123
barrel-like structures, 575
Barth syndrome, 201
basal laminas, 598
basal metabolic rate (BMR), 524
base excision repair (BER), 369, 370f, 370t
base pairing in DNA, 339, 340f, 341
base pairs (bp), 355
base substitution, mutations occurring by, 396–397, 396f, 397f, 398f
bases
 conjugate, 11
 as proton acceptors, 10
 strong, 10–11
 as unprotonated species, 11
 weak. *See* weak bases
base-stacking forces, 340
basophils, 656–657, 662
BAT (brown adipose tissue), 123–124, 247, 247f
BAX, 693f, 694

BCL-2, in apoptosis, [693f](#), [694](#)
Becker muscular dystrophy, [622](#)
bends, in proteins, [36](#), [37f](#)
benzoate, metabolism of, [298](#), [298f](#)
BER (base excision repair), [369](#), [370f](#), [370t](#)
beriberi, [534](#)
beta-anomers, [143](#)
 β -oxidation of fatty acids, [208–210](#), [208f](#), [209f](#), [210t](#)
 ketogenesis regulation and, [213–214](#), [213f](#), [214f](#)
 modified, [210](#), [211f](#)
 β barrels, [36](#), [37f](#)
 β sheets, as secondary structure unit, [36](#), [36f](#), [37f](#)
 β turns, [36](#), [37f](#)
 β -oxidation, [131](#)
BgIII, [433t](#)
BHA (butylated hydroxyanisole), [204](#)
BHT (butylated hydroxytoluene), [204](#)
Bi-Bi reactions, [79](#), [79f](#), [80f](#)
bicarbonate, carbon dioxide conversion to, [52](#), [53f](#)
bicarbonate in extracellular and intracellular fluid, [460t](#)
bifunctional enzymes, [176](#)
bilayers, lipid, [462–463](#), [462f](#)
 membrane proteins and, [463](#)
 thickness of, [589](#)
bile, bilirubin secretion into, [312–313](#), [313f](#)
bile acids (salts), [202](#), [249](#), [255–256](#), [255f](#)
bile duct obstruction, hyperbilirubinemia caused by, [313f](#), [313t](#), [314–315](#),
 [315t](#)
bile pigments, biomedical importance of, [305](#)
bile salts, [521](#)
biliary tree obstruction, hyperbilirubinemia caused by, [313f](#), [313t](#), [314–](#)
 [315](#), [315t](#)
bilirubin
 conjugation of, [312](#), [312f](#), [313f](#)
 elevated levels of, [305](#), [313–314](#), [313t](#)
 excretion of, [312–313](#), [313f](#)
 from heme catabolism, [311–313](#), [312f](#), [313f](#)

- intestinal bacteria reduction of, 313
- metabolic disorders of, 314–315, 314*f*, 315*t*
- serum measurement of, 313, 315, 315*t*, 566
- structure of, 311, 312*f*
- transport of, 311–312

δ-bilirubin, 315

bilirubin diglucuronide, 312, 312*f*

bilirubin UDP-glucuronosyltransferase, 312, 314

biliverdin, 311, 312*f*

biliverdin reductase, 311, 312*f*

bimolecular lipid bilayer, 462

binding change mechanism, of ATP synthase, 121, 122*f*

binding constant, Michaelis constant as approximation of, 75–76

binding domains, 37, 38*f*

binding immunoglobulin protein (BiP), 581, 582*f*

biochemical case histories

- alcoholism, 720
- biotin, 724–725
- carnitine, 723–724
- diabetes mellitus, 719–720, 725–726
- glucose-6-phosphate dehydrogenase, 721–722
- glutathione, 721

biochemistry, 1–4, 2*f*, 3*f*

- clinical. *See* laboratory tests

bioenergetics

- ATP as cellular energy currency, 108–110, 108*f*, 109*f*, 121–122
- biomedical importance of, 105
- coupling of endergonic and exergonic reactions, 106–107, 106*f*, 107*f*, 109
- energy capture and transfer by high-energy phosphates, 107–108, 107*t*, 108*f*, 121–122
- free energy in biologic systems, 105–106

bioengineering, 3

bioethics, 3

bioinformatics, 3, 31

biomarkers

- of cardiovascular risk, 567

- enzymes used as, [64](#), [65f](#)
- tumor, [700–701](#), [701t](#)
- biophysics, [3](#)
- biopolymers, enzymatic synthesis of, [9](#)
- biotechnology, [3](#)
- biotin
 - case study of, [724–725](#)
 - deficiency of, [528t](#), [538](#)
 - functions of, [528t](#), [539](#)
 - in malonyl-CoA synthesis, [217](#), [217f](#)
 - structure of, [538](#), [538f](#)
- BiP (binding immunoglobulin protein), [581](#), [582f](#)
- 1,3-bisphosphoglycerate, in glycolysis, [159](#), [159f](#), [160f](#)
- 2,3-bisphosphoglycerate (2,3-BPG), [648](#)
 - hemoglobin binding of, [50f](#), [53](#), [53f](#)
- bisphosphoglycerate mutase, [161](#), [161f](#)
- 2,3-bisphosphoglycerate phosphatase, [161](#), [161f](#)
- 2,3-bisphosphoglycerate synthase/2-phosphatase (BPGM), [53](#)
- bleeding disorders, [678](#)
- bleeding time, [679](#)
- bleomycin, [14](#)
- blindness, vitamin A deficiency causing, [530](#)
- blistering, [625](#)
- blood
 - bilirubin in, [313–315](#), [313t](#), [315t](#)
 - metabolism integration by, [132–133](#), [132f](#), [133f](#)
- blood, functions of, [628](#), [628t](#). *See also* plasma proteins
- blood cells
 - derivation from hematopoietic stem cells, [646–647](#), [647f](#)
 - red. *See* red blood cells
 - white. *See* white blood cells
- blood clots
 - formation of, [87](#). *See also* fibrin clot formation
 - vitamin K role in, [532–533](#), [533f](#)
- blood coagulation. *See* coagulation, blood
- blood glucose
 - biomedical importance of, [172](#)

- clinical aspects of, [180–181](#), [180f](#)
- free fatty acids and, [245](#), [245f](#)
- glucose oxidase in measurement of, [64](#)
- glucose tolerance measurement of, [180–181](#), [180f](#)
- glycated hemoglobin in measurement of, [55](#), [553](#)
- glycogen in maintenance of, [164](#)
- red blood cells and, [648](#)
- regulation of
 - glucokinase role in, [178–179](#), [179f](#)
 - hormonal mechanisms, [178–180](#), [178t](#), [179t](#)
 - metabolic mechanisms, [178](#), [178t](#)
 - narrow limits of, [177](#)
- renal threshold for, [180](#)
- sources of, [177–178](#), [178f](#)
- blood group, [653–654](#), [654f](#)
- blood samples, [563](#)
- blood transfusion, ABO system importance in, [653](#)
- blood type, [654](#)
- blood vessels, nitric oxide affecting, [622–623](#), [624f](#)
- blot transfer techniques, [438](#), [439f](#)
- blotting techniques, [438](#), [439f](#)
- blunt end ligation, [434–435](#)
- blunt ends, [433](#), [434f](#)
- BMPs (bone morphogenetic proteins), [635](#)
- BMR (basal metabolic rate), [524](#)
- Bohr effect, [52](#), [53f](#)
- bond energies, of biologically significant atoms, [7t](#)
- bonds, biomolecule stabilization by, [7](#), [7t](#)
- bone
 - components of, [604–607](#), [605t](#), [606f](#)
 - metabolic and genetic disorders of, [607](#), [607t](#)
 - vitamin K role in, [533](#)
- bone marrow
 - heme synthesis in, [306](#)
 - transplantation of, [235](#)
- bone morphogenetic proteins (BMPs), [635](#)
- botulinum B toxin, [587](#)

boundary elements, [425](#)
bovine preproparathyroid hormone, [495f](#)
bp (base pairs), [355](#)
2,3-BPG. *See* 2,3-bisphosphoglycerate
BPGM (2,3-bisphosphoglycerate synthase/2-phosphatase), [53](#)
bradykinin, [674](#)
brain
 in fasting state, [130](#), [138–139](#), [138t](#), [139f](#), [139t](#)
 in fed state, [130](#), [136–138](#), [137f](#), [138t](#)
 glucose requirement of, [136](#)
branch point, of glycogen, [166](#)
branched-chain amino acids, carbon skeleton catabolism of, [288](#), [290](#),
 [292f](#), [293](#), [293f](#), [293t](#)
branched-chain ketonuria, [290](#), [293](#), [293t](#)
branching enzyme, in glycogenesis, [165–166](#), [165f](#), [166f](#)
brefeldin A, [243](#), [588](#)
broad β -disease, [258t](#)
3-bromopyruvate, [696](#), [698t](#)
brown adipose tissue (BAT), [123–124](#), [247](#), [247f](#)
brush border enzymes, [520](#)
budding of vesicles, [586–587](#), [587f](#)
buffering, [12](#)
buffers
 Henderson-Hasselbalch equation describing, [12](#), [12f](#)
 weak acids acting as, [12–13](#), [12f](#)
bulk flow, in transport vesicles, [587](#)
bursa of Fabricius, [662](#)
butylated hydroxyanisole (BHA), [204](#)
butylated hydroxytoluene (BHT), [204](#)
butyric acid, [197t](#), [210](#)

C

C2c2, [434t](#), [435](#)
C₂₀ polyunsaturated acids, eicosanoids formed from, [224](#), [225f](#), [226f](#)
CA (carbonic anhydrase), [52](#), [53f](#), [648](#)
CA II (carbonic anhydrase II), [607](#)
Ca²⁺. *See* calcium

Ca²⁺/calmodulin-sensitive phosphorylase kinase, glycogenolysis
activation by, 168

cachexia, 138, 139, 157, 525

CAD (caspase-activated DNase), 692

caffeine, 321, 323*f*
hormonal regulation of lipolysis and, 246

calbindin, 523

calcidiol, 531, 531*f*

calciferol. *See* vitamin D

calcinosis, 532

calcitriol (1,25(OH)₂-D₃), 530–531, 531*f*
biosynthesis of, 489–491
storage of, 497, 497*t*

calcium (Ca²⁺)
absorption of, 523
in cardiac muscle contraction, 619–620, 620*f*, 620*t*
enzyme and protein regulation by, 506, 506*t*
in extracellular fluid, 460, 460*t*
glycogen phosphorylase activation by, 168
as hormone action mediator, 507
human requirement for, 93, 93*t*
in intracellular fluid, 460, 460*t*
in malignant hyperthermia, 618
metabolism of, 506
in muscle contraction, 611, 616–619, 617*f*, 617*t*, 618*f*
phosphatidylinositide metabolism and, 507–508, 507*f*, 508*f*
sarcoplasmic reticulum and, 618, 618*f*
as second messenger, 86, 482, 483*t*, 502
vitamin D regulation of, 531

calcium channels in cardiac muscle, 619–620, 620*f*, 620*t*

calcium-binding proteins, vitamin K role in, 532–533, 533*f*

caldesmon, 617–618

calmodulin, 168, 506, 506*t*, 615, 617

calnexin, 551–552, 584

calreticulin, 552, 584

calsequestrin, 618, 618*f*

cAMP. *See* cyclic AMP
3', 5'-cAMP, as second messenger, 86
cAMP-dependent protein kinase
 glycogen regulation by, 167–168, 169*f*, 170, 171*f*
 structure of, 38*f*
CAMs (cell adhesion molecules), 698, 700*t*
cancer. *See also* chemotherapy
 angiogenesis in, 696–698
 apoptosis in, 681–682, 692–694, 693*f*, 694*t*
 biomarkers of, 700–701, 701*t*
 biomedical importance of, 681
 carcinogenesis in, 682–683, 688
 causes of. *See* carcinogens
 cell cycle abnormalities in, 691
 cell features in, 681, 682*f*
 colorectal, 370*t*, 687–688, 688*f*, 688*t*
 copy number variation in, 692, 692*f*
 epigenetic mechanisms involved in, 690
 extracellular vesicles and, 690
 folate metabolism inhibition in treatment of, 537
 folic acid supplements for, 538
 free radical damage causing, 542
 genetic analyses of, 701
 genetic damage in, 683
 genomic instability and aneuploidy in, 691–692, 692*f*
 glycoproteins in, 552
 growth factor role in, 689, 689*t*
 hereditary, 683, 688, 690–691, 691*t*
 hyperbilirubinemia caused by, 313*f*, 313*t*, 314
 hypermetabolism in, 157
 immunologic aspects of, 698–700
 incidence of, 681
 metabolism in, 695–696, 697*f*, 698*t*
 metastatic process in, 698, 699*f*, 700*t*
 micro-RNA in, 689–690
 molecular profiling of, 703
 neoplasms and, 681–682, 682*f*

new therapies for, 701–703, 702*t*, 703*f*
ω3 fatty acids and, 199
oncogene role in, 685–688, 685*t*, 686*f*, 687*f*, 687*t*, 688*f*, 688*t*
prevention of, 703, 703*t*
pro-oxidant paradox and, 544–545
selectins in, 554
signaling pathways in, 689, 689*t*
stem cells in, 696
telomerase activity in, 692
tumor microenvironment in, 682, 694–695, 695*f*
tumor suppressor gene role in, 685–688, 685*t*, 686*f*, 687*f*, 687*t*, 688*f*,
688*t*
undernutrition in, 525
vitamin B₆ and, 535
xenobiotic role in, 556–557, 559, 559*f*

cancer cells
 cyclins and, 369
 membrane abnormalities and, 478*t*

cancer phototherapy, 308

CAP (catabolite activator protein), 412

cap of mRNA, 345, 345*f*

caproic acid, 197*t*

carbamates, hemoglobin transport of, 52, 53*f*

carbamoyl phosphate
 excess, 336
 in urea synthesis, 275–276, 275*f*

carbamoyl phosphate synthetase I
 defects in, 277, 277*t*
 in urea synthesis, 275–276, 275*f*

carbamoyl phosphate synthetase II, in pyrimidine synthesis, 332, 333*f*, 334

“carbohydrate excess syndrome,” 247

carbohydrate loading, 164

carbohydrate-deficient transferrin, 633

carbohydrates
 as aldehyde or ketone derivatives of polyhydric alcohols, 141–142, 142*t*
 biological information encoded in, 141
 biomedical importance of, 141

blood glucose derived from, 177–178, 178f
in cell membranes, 147
cell surface, glycolipids and, 202
classification of, 141–142, 142t
diets low in, 181
digestion and absorption of, 520, 520f
disaccharides. *See* disaccharides
energy yields from, 138t
glycoproteins. *See* glycoproteins
in lipoproteins, 147
metabolic pathways of, 130, 130f, 131f
 in fasting state, 138–139, 138t, 139t
 in fed state, 136–138, 137f, 138t
 at tissue and organ levels, 132–133, 132f, 133f
 vitamin B₁ role in, 533–534
monosaccharides. *See* monosaccharides
polysaccharides. *See* polysaccharides
carbon dioxide (CO₂)
 carbonic anhydrase and, 648
 citric acid cycle production of, 151–153, 152f
 hemoglobin transport of, 52, 53f
carbon monoxide
 heme binding of, 49, 49f
 respiratory chain inhibition by, 112, 118, 123
carbonic acid
 carbon dioxide conversion to, 52, 53f
 pK_a of, 13t
carbonic anhydrase (CA), 52, 53f, 648
carbonic anhydrase II (CA II), 607
γ-carboxyglutamate, synthesis of, 532–533, 533f
γ-carboxyglutamic acid, 17, 17f
carboxyl transferase, 217, 217f
carboxylases, biotin coenzyme of, 539
carboxypeptidase A, active site of, 59f
carboxypeptidases, 521
carboxy-terminal domain (CTD), 383–384, 415

carcinoembryonic antigen (CEA), 700
carcinogenesis, 682–683, 688
carcinogens
 chemical, 556–557, 559, 559*f*, 683–684, 683*t*, 684*f*
 radiation, 683, 683*t*
 viruses, 684–685, 684*t*, 686*f*, 703
carcinoid syndrome, 535
cardiac glycosides, 145, 202
cardiac muscle, 612
 calcium channels in, 619–620, 620*f*, 620*t*
 contraction regulation in, 619, 619*t*
cardiac troponins, 64
cardiolipin, 200*f*, 201
 mitochondrial compartmentalization of, 118
 synthesis of, 230, 230*f*, 231*f*
cardiomyocytes, turnover rate of, 708*t*
cardiomyopathies, 621–622, 622*t*
cardiovascular disease
 biomarkers of, 567
 folic acid supplements for, 538
 lipids and, 198
 ω 3 fatty acids and, 199
caretaker tumor suppressor genes, 686–687
cargo proteins/molecules, 578, 578*f*, 586–587
carnitine
 deficiency of, 207, 214–215
 in fatty acid transport, 208, 208*f*
 liver and muscle, 723*t*
 urinary excretion of, 724*t*
carnitine palmitoyltransferase, 207
carnitine palmitoyltransferase-I (CPT-I)
 deficiency of, 215
 in fatty acid transport, 208, 208*f*
 in ketogenesis regulation, 213, 213*f*
carnitine palmitoyltransferase-II (CPT-II)
 deficiency of, 215
 in fatty acid transport, 208, 208*f*

carnitine-acylcarnitine translocase, 208, 208*f*
carnosinase, deficiency of, 303
carnosine, biosynthesis of, 298, 298*f*, 303
carnosinuria, 303
 β -carotene, 529, 529*f*
 as antioxidant, 204
 as pro-oxidant, 544
carrier proteins, 468–469, 469*f*
carrier systems, for sugar nucleotides in glycoprotein synthesis, 549–550
cartilage, 601–602, 607–608, 608*f*, 608*t*, 609*f*
caspase-activated DNase (CAD), 692
caspases, 692–694, 693*f*
catabolic pathways, 129
catabolism, 106
 respiratory chain capture of energy from, 121–122
catabolite activator protein (CAP), 412
catalase, 114, 273, 544, 649
 as antioxidant, 204
catalysis (enzymatic)
 acid–base, 59–60, 60*f*
 active site role in, 58–59, 59*f*
 biomedical importance of, 56
 conformational changes in, 60, 60*f*
 covalent, 59–61, 59*f*, 61*f*, 62*f*
 enzyme detection by, 62–63, 62*f*, 63*f*
 free-energy changes of, 69–70, 70*f*
 by isozymes, 61–62
 kinetics of. *See* enzyme kinetics
 prosthetic group, cofactor, and coenzyme roles in, 57–58, 58*f*
 by proximity, 59
 residues conserved in, 61
 site-directed mutagenesis in study of, 66
 specificity of, 57, 57*f*
 by strain, 59
catalysts
 enzymes as, 9, 57, 57*f*
 oxaloacetate as, 150–151, 151*f*

ribozymes as, 66–67
RNA as, 391
catalytic constant (k_{cat}), 75
catalytic efficiency ($k_{\text{cat}}/K_{\text{m}}$), 75
catalytic site. *See* active site
cataract, diabetic, 190–191
catecholamine oxidases, copper in, 98–100, 99f
catecholamines
 storage of, 497, 497t
 synthesis of, 491–492, 491f
caveolae, 466, 466f
caveolin-1, 466, 466f
CBG (corticosteroid-binding globulin), 498–499, 498t
CBP (CREB-binding protein), 513–514, 514t
CBP/p300 and signal transduction pathways, 513–514, 513f, 514t
CD59, 554
CDK–cyclin inhibitor (CKI), 372
CDKs. *See* cyclin-dependent kinases
cDNA library, 438
CEA (carcinoembryonic antigen), 700
celiac disease, 519
cell, macromolecule transport in, 474–475, 474f, 475f, 477f
cell adhesion, glycosphingolipids in, 234
cell adhesion molecules (CAMs), 698, 700t
cell cycle
 cancer abnormalities in, 691
 delay or arrest of, 371, 371f
 phases of, 368, 368f
 regulation of, 585
 S phase of, DNA synthesis during, 368–369, 368f, 369f, 369t
cell death. *See* apoptosis
cell division, checkpoints in, 90, 90f
cell growth, 603
cell membranes
 carbohydrates in, 147
 vitamin E in, 532

cell migration, [598](#), [601](#)
cell recognition, glycosphingolipids in, [234](#)
cell signaling
 phosphatidylcholines in, [200](#)
 phosphatidylinositols in, [200](#)
cell–cell communication
 with gap junctions, [476](#), [476f](#)
 heparan sulfate and, [603](#)
cell–cell interactions, [459](#)
cell-mediated immunity, [639](#)
cellulose, [146–147](#), [148f](#)
cellulose acetate zone electrophoresis, [628](#), [629f](#)
central core disease, [618](#), [620t](#)
central nervous system (CNS), glucose requirement of, [136](#)
centromere, [355](#), [355f](#)
cephalin (phosphatidylethanolamine), [200](#), [200f](#)
 membrane asymmetry and, [464](#)
 synthesis of, [230](#), [230f](#), [231f](#)
ceramide, [200](#), [202f](#)
 accumulation of, [235](#)
 in membranes, [461](#)
 in sphingolipid synthesis, [233–234](#), [234f](#)
 synthesis of, [233](#), [233f](#)
cerebrohepatorenal (Zellweger) syndrome, [215](#), [579–580](#), [580t](#)
cerebrosides, [234](#)
ceruloplasmin, [631](#), [631f](#), [633–634](#)
 diagnostic use of, [64t](#)
cervonic acid, [197t](#)
CF (cystic fibrosis), [64](#), [478](#), [478t](#), [519](#), [585t](#)
cGMP. *See* cyclic GMP
chain elongation, [376f](#), [378](#). *See also* elongation
chain initiation, [376f](#), [378](#). *See also* initiation
chain termination, [376f](#), [378–379](#). *See also* termination
chain termination method, [439](#), [440f](#)
chain-breaking antioxidants, [204](#)
chalones, [227](#)
channeling, in citric acid cycle, [151](#)

channelopathies, [620](#), [620t](#)
channels, amphipathic helices in, [36](#)
chaperones, [41](#)
 ATP-dependent protein binding to, [576](#)
 histone, [353](#)
 misfolded proteins and, [584–585](#), [585f](#), [585t](#)
 properties of, [576t](#)
 in protein folding, [574–575](#)
 in protein sorting, [575t](#), [576](#)
 in quality control, [584](#), [584t](#)
 in translocation, [576](#), [577f](#)
chaperonins, [41](#), [575](#)
charged groups, noncovalent interactions of, [8](#)
charged paddle, [471](#), [471f](#)
charge-relay network, [61](#), [61f](#)
charging, in protein synthesis, [395](#), [395f](#)
checkpoint controls, [372](#)
checkpoint kinases 1 and 2 (CHK1 and CHK2), [371](#), [371f](#)
checkpoints, in cell division, [90](#), [90f](#)
Chèdiak-Higashi syndrome, [585t](#)
chemical carcinogenesis, [559](#), [559f](#)
chemical carcinogens, [556–557](#), [559](#), [559f](#), [683–684](#), [683t](#), [684f](#)
chemical chaperone therapy, [235](#)
chemical equations
 balancing of, [69](#)
 kinetic order of, [71](#)
chemical mechanisms and reactive oxygen species, [713](#)
chemical potential, [105](#)
chemical reactions
 catalysis of. *See* catalysis
 coupling of, [106–107](#), [106f](#), [107f](#), [109](#)
 equilibrium of, [69](#), [71–72](#)
 free-energy changes of. *See* free energy
 mechanisms of, [69](#)
 multisubstrate, [79](#), [79f](#), [80f](#)
 rate-limiting, [84](#)
 rates of. *See* rate of reaction

- reversibility of, [69](#)
- transition states of, [69–70](#), [70f](#)
- chemiosmotic theory, [121](#), [122f](#), [124](#)
- chemokines, [658](#), [658f](#), [662](#)
- chemotaxis, [657–658](#)
- chemotherapy
 - folate metabolism inhibitors, [537](#)
 - new therapies, [701–703](#), [702t](#), [703f](#)
 - resistance to, [702–703](#), [702t](#)
 - synthetic nucleotide analogs in, [324–325](#), [324f](#), [325f](#)
- chenodeoxycholic acid, [255–256](#), [256f](#)
- chenodeoxycholyl-CoA, [255](#), [256f](#)
- children, kwashiorkor in, [525](#)
- chimeric gene approach, [422f](#), [423](#), [424f](#)
- chimeric molecules
 - purpose of, [432](#)
 - restriction enzymes for
 - DNA chain cleavage with, [433–434](#), [433t](#), [434f](#), [434t](#)
 - preparation with, [434–435](#)
- ChIP (chromatin immunoprecipitation), [447](#), [448f](#)
- ChIP-chip, [447](#)
- ChIP-Exo, [447](#)
- ChIP-Seq, [447](#)
- chitin, [147](#), [148f](#)
- CHK1 and CHK2 (checkpoint kinases 1 and 2), [371](#), [371f](#)
- chloramines, [661](#)
- chloride (Cl⁻)
 - in extracellular and intracellular fluid, [460](#), [460t](#)
 - permeability coefficient of, [463f](#)
- chlorinated oxidants, production of, [662](#)
- chlorobutanol, uronic acid pathway effects of, [189](#)
- chlorophyll, [305](#)
- cholecalciferol. *See* vitamin D₃
- cholera
 - glucose transport in treatment of, [474](#)
 - toxin, [202](#), [202f](#), [234](#), [504](#)

cholestatic jaundice, [314](#)

cholesterol

absorption of, [521](#)

in bile acid synthesis, [254–256](#), [256f](#)

biomedical importance of, [249](#)

clinical aspects of, [256–257](#), [258t](#)

dietary, [250](#), [257](#)

excretion of, [254–256](#), [256f](#)

fructose effects on, [186](#), [188f](#), [189–190](#)

function of, [202](#)

in high-density lipoproteins in, [241–242](#), [241f](#)

HMG-CoA reductase regulation and, [86](#)

hormone synthesis from, [202](#), [249](#), [483](#), [484f](#), [485–491](#), [485f](#)

in lipoprotein, [236–237](#), [238f](#)

in membranes, [461](#), [589](#)

fluid mosaic model and, [465–466](#)

metabolic pathways of, [130–131](#), [131f](#)

plasma levels of

atherosclerosis and coronary heart disease and, [202](#), [250](#), [256–257](#)

dietary changes and, [257](#)

drug therapy and, [257](#)

lifestyle changes and, [257](#)

synthesis of

acetyl-CoA pathway for, [250–251](#), [250f](#), [251f](#), [252f](#)

diurnal variation in, [252](#)

HMG-CoA reductase regulation of, [252–253](#), [253f](#)

in tissues, [203](#), [203f](#)

factors influencing balance of, [253](#), [254f](#)

transport of

with lipoproteins, [253–254](#), [255f](#)

reverse, [241f](#), [242](#), [250](#), [254](#), [254f](#), [257](#)

cholesterol 7 α -hydroxylase, [255](#), [256f](#)

cholesteryl ester hydrolase, [253](#)

cholesteryl ester transfer protein, [238](#), [254](#), [255f](#), [257](#)

cholesteryl esters, [203](#), [253–254](#), [255f](#)

in HDL metabolism, [241f](#), [242](#)

in lipoprotein core, [236](#), [237](#), [238f](#)

cholesterylation, 463
cholic acid, 255, 256*f*
choline, 200, 200*f*, 201*f*
 deficiency of, fatty liver and, 244
 membrane asymmetry and, 464
choluric jaundice, 313–314
cholyl-CoA, in bile acid synthesis, 255, 256*f*
chondrodysplasias, 608–609
chondroitin sulfate, 147, 148*f*, 595, 599, 601–602, 601*f*, 602*t*, 604, 604*t*,
 608*f*
chondronectin, 608, 608*t*
chorion protein genes, 429, 429*f*
choroid, gyrate atrophy of, 282
chromatids, 355, 355*f*, 355*t*, 356*f*, 361, 361*f*
chromatin
 active regions of, 353–354, 354*f*, 418
 components of, 351, 351*f*
 covalent modifications of, 87
 gene expression and template for, 418–419
 higher order structure and compaction of, 352*f*, 353
 inactive regions of, 354, 418
 physiologic roles of, 101
 reconstitution in DNA replication, 368
chromatin fibers, 352*f*, 353
chromatin fibrils, 352*f*, 353
chromatin immunoprecipitation (ChIP), 447, 448*f*
chromatin modifying complex (CMC), 420
chromatography
 affinity, 25–26
 recombinant fusion protein purification with, 65–66, 66*f*
 column, 24, 25*f*
 high-pressure liquid, 24, 25*f*
 laboratory tests using, 564
 hydrophobic interaction, 25
 ion-exchange, 25
 protein and peptide purification with, 23–26, 25*f*
 size-exclusion, 24–25, 25*f*

chromium
 human requirement for, 93, 93*t*
 multivalent states of, 93, 94*f*, 94*t*
 toxicity of, 95*t*

chromosomal instability (CIN), 692, 692*f*

chromosomal translocations, in cancer, 685, 686*f*

chromosome walking, 445, 445*f*

chromosomes
 coding regions of, 355–356, 357*f*
 gene conversion, 361
 gene localization to, 441, 442*t*
 integration of, 359–360, 360*f*
 integrity of, monitoring, 372
 interphase, 353
 metaphase, 352*f*, 355, 355*t*, 356*f*
 organization of, 355, 355*f*, 355*t*, 356*f*
 polytene, 354
 recombination of, 359, 359*f*, 360*f*
 scaffolding in, 352*f*, 353
 sister chromatid exchange, 361, 361*f*
 transposition, 360, 442

chronic granulomatous disease, 661

chronic myelocytic leukemia (CML), 701

chyle, 238

chylomicron remnants, 237*t*, 238
 formation of, 240–241
 liver uptake of, 239*f*, 241

chylomicrons, 133, 133*f*, 137–138, 237, 237*t*
 apolipoproteins of, 238
 in lipid transport, 236
 metabolism of, 239*f*, 240–241
 in triacylglycerol transport, 238–239, 239*f*, 240*f*

chymotrypsin, 521
 activation of, 87–88, 88*f*
 covalent catalysis of, 60–61, 61*f*

cI repressor gene, 415, 415*f*

cI repressor protein, 415–416, 416*f*

CIN (chromosomal instability), 692, 692f
circular RNAs (circRNAs), 348
circulation
 enterohepatic, 521
 metabolism integration by, 132–133, 132f, 133f
cirrhosis, 150, 226, 243, 244
cis, trans-isomerization, of X-Pro peptide bonds, 42, 42f
cisternal maturation, 588
cistron, 411
citrate
 in citric acid cycle, 150–151, 151f, 152f
 in lipogenesis regulation, 218, 221, 221f
citrate lyase, 154–155, 155f
 regulation of, 89t
citrate synthase
 in citric acid cycle, 151, 152f
 regulation of, 156
citric acid, 13t
citric acid cycle, 130, 130f, 131f
 ATP generation by, 151, 151f, 153
 biomedical importance of, 150
 carbon dioxide produced by, 151–153, 152f
 in energy conservation and capture, 108
 glycolysis route to, 161–163, 162f
 mitochondrial location of, 134, 134f, 151
 pivotal metabolic role of, 153–156, 154f, 155f
 reducing equivalents produced by, 151–153, 152f
 regulation of, 155–156
 respiratory chain substrates provided by, 150–151, 151f
 at subcellular level, 134, 134f
 vitamins essential to, 153
citrullination, 661, 661f
citrulline, in urea synthesis, 275–276, 275f
citrullinemia, 278
CJD (Creutzfeldt-Jakob disease), 42
CKI (CDK–cyclin inhibitor), 372
Cl⁻. *See* chloride

class B scavenger receptor B1 (SR-B1), [241f](#), [242](#)
classic pathway of complement activation, [643](#)
clathrin, [253](#), [474f](#), [475](#), [586](#), [586t](#)
clinical biochemistry. *See* laboratory tests
clinical value, of laboratory tests, [562–563](#), [563t](#)
clofibrate, [257](#)
cloning, [435–438](#), [436f](#), [437f](#), [437t](#)
cloning vectors, [436](#), [436f](#), [437t](#)
clopidogrel, [672](#)
closed complex, [376f](#), [379](#)
closure time, [679](#)
clotting. *See* fibrin clot formation
CMC (chromatin modifying complex), [420](#)
CML. *See* chronic myelocytic leukemia
CML (chronic myelocytic leukemia), [701](#)
CMP (cytidine monophosphate), [322t](#)
CNS (central nervous system), glucose requirement of, [136](#)
CNV. *See* copy number variation
CO₂. *See* carbon dioxide
coactivators, transcription, [383–385](#), [385t](#)
coagulation, blood
 disorders of, [655](#)
 prostaglandins in, [216](#)
coagulation factors, [672](#), [673f](#), [673t](#), [674t](#)
 deficiencies of, [678](#)
 vitamin K–dependent carboxylation of, [677–678](#)
coagulation system. *See also* hemostasis
 anticoagulant drug effects on, [677–678](#)
 biomedical importance of, [669](#)
 endothelial cell actions in, [670](#), [672](#)
 fibrin clot formation in. *See* fibrin clot formation
 inherited deficiencies of, [678](#)
 laboratory tests measuring, [679](#)
 platelet aggregation in, [670](#), [671f](#)
 thrombi types in, [670](#)
 thrombin inhibition in, [677–678](#)
 thrombin regulation in, [677](#)

coat proteins, 583, 586–587, 586*t*, 587*f*
coated pits, 475
cobalamin. *See* vitamin B₁₂
cobalophilin, 536
cobalt
 human requirement for, 93, 93*t*
 multivalent states of, 93, 94*f*, 94*t*
 physiologic roles of, 98
 toxicity of, 95*t*
cobamide, 58
code erasers, 418
code readers, 418
code writers, 418
coding regions, 355–356, 357*f*
coding strand
 in DNA replication, 339, 344*f*
 in RNA synthesis, 375, 380*f*
codons, 15, 393
 amino acid sequence and, 394, 394*t*
 anticodon recognition of, 395–396, 396*f*
 nonsense, 394, 397–398, 398*f*
 stop, 403–404, 404*f*
 tables of usage of, 395
coenzyme A, 58
 cysteine conversion to, 297
 pantothenic acid in, 539, 539*f*
coenzyme Q (Q, ubiquinone), 203
 in cholesterol synthesis, 250–251, 251*f*
 in respiratory chain, 118, 119*f*, 120, 120*f*, 121*f*
coenzymes, 57–58, 58*f*
 laboratory tests for, 564–565
 nicotinamide oxidation and reduction, 113, 113*f*
 nucleotide derivatives, 323, 324*t*
cofactors, 57–58, 58*f*
cognate receptor, 502
colchicine, 625
collagen, 406

- abundance of, 592
- in bone, 604–605, 605*t*
- in cartilage, 607–608, 608*f*, 608*t*
- chondrodysplasias, 595, 608–609
- classification of, 594, 594*f*
- cross-linking of, 553
- defects in, 263–264
- diseases caused by abnormalities in, 595–596, 595*t*
- elastin compared with, 597*t*
- fibril formation by, 593–594
- fibronectin interaction with, 597, 598*f*
- as fibrous protein, 43
- O-glycosidic linkages in, 549
- nutritional and genetic disorders of, 43–44
- osteogenesis imperfecta and, 607, 607*t*
- platelet adhesion to, 670, 671*f*
- posttranslational modification of, 594–595, 594*t*
- posttranslational processing of, 42–44, 43*f*
- structure of, 592–594, 593*f*, 594*f*
- synthesis of, 43
- triple helix structure of, 43, 43*f*
- types of, 593*t*
- vitamin C effects in, 539

collision theory, 70

colony-stimulating factor, 647

colorectal cancer

- development of, 687–688, 688*f*, 688*t*
- mismatch repair in, 370*t*

column chromatography, protein and peptide purification with, 24, 25*f*

combinatorial chemistry, 63

common lymphoid progenitor, 657

common myeloid progenitor, 657

compartmentation

- metabolic regulation with, 83–84
- of mitochondria, 118, 118*f*

competitive inhibitors, 76–78, 77*f*, 78*f*

competitive ligand-binding assays, laboratory tests using, 565

complement, 539
complement system (cascade), 643–644, 644*f*
complementarity
 of DNA, 341, 341*f*, 438
 of RNA, 342–343, 344*f*, 346
complementarity-determining regions, 640
complementary DNA (cDNA) library, 438
complex carbohydrates, glycoproteins as, 546
Complex I. *See* NADH-Q oxidoreductase
Complex II. *See* succinate-Q reductase
Complex III. *See* Q-cytochrome *c* oxidoreductase
Complex IV. *See* cytochrome *c* oxidase
complex lipids, 196
complex oligosaccharides, in glycoproteins, 550–551, 550*f*
complexation, of transition metals, 95–97, 95*f*, 96*f*, 96*t*, 97*f*
compulsory-order reactions, 79, 79*f*
concanavalin A, 147
conformational disorders, 590
conformations
 of enzymes, 60, 60*f*
 hemoglobin changes in, 51–52, 51*f*, 52*f*
 of proteins
 biomedical importance of, 33
 configuration versus, 33–34
 native, 41
 pathologic diseases of, 42
 peptide bond restrictions on, 34–35, 34*f*
congenital contractural arachnodactyly, 597
congenital disorders of glycosylation, 633
congenital erythropoietic porphyria, 310, 310*t*
congenital forms of muscular dystrophy, 622
congenital long QT syndrome, 478*t*
congenital muscular dystrophies, glycoprotein synthesis defects in, 554
conjugate acid, 11
conjugate base, 11
conjugated bilirubin, 312, 312*f*, 313*f*
conjugated double bonds, in porphyrins, 308, 310*f*

conjugated hyperbilirubinemia, [313f](#), [313t](#), [314–315](#)
conjugation reactions, of xenobiotics, [558](#)
connective tissue, [592](#). *See also* extracellular matrix
connexin, [476](#), [476f](#)
connexon channel, [476](#), [476f](#)
consensus sequences, [383–384](#), [388f](#)
 Kozak, [401](#)
constitutive gene expression, [411](#), [414](#)
constitutive heterochromatin, [354](#)
constitutive mutation, [411](#)
constitutive proteins, [84](#)
constitutive secretion, [574](#)
contact sites, [576](#)
contraction, muscle. *See* muscle contraction
convalescence, protein replacement during, [526](#)
Coomassie Blue dye, [26](#), [26f](#)
cooperative binding
 of hemoglobins, [51](#)
 Hill equation for, [76](#), [76f](#)
coordinate expression, [412](#)
COPI vesicles, [583](#), [586](#), [586t](#), [588](#)
COPII vesicles, [583](#), [586](#), [586t](#), [587f](#)
copper, [634](#)
 absorption of, [101](#)
 in Complex IV, [120](#), [120f](#)
 in cytochrome oxidase, [97](#)
 deficiency of, [43](#), [263](#)
 human requirement for, [93](#), [93t](#)
 multivalent states of, [93](#), [94f](#), [94t](#)
 physiologic roles of, [98–100](#), [99f](#)
 toxicity of, [95t](#)
copper toxicosis, [634](#)
coproporphyrinogen III, in heme synthesis, [307](#), [307f](#), [308f](#), [309f](#)
coproporphyrinogen oxidase, [307](#), [308f](#), [309f](#), [310t](#)
coprostanol (coprosterol), [254](#)
copy number variation (CNV), [442](#)
 in cancer, [692](#), [692f](#)

coregulators, transcription, [383–385](#), [385t](#), [513–514](#), [513f](#), [514t](#)
corepressor family, [514](#), [514t](#)
Cori cycle, glucose derived from, [177](#), [178f](#)
cornea, [602](#)
coronary (ischemic) heart disease. *See also* atherosclerosis
 cholesterol and, [257](#)
corrinoids, [536](#)
corticosteroid-binding globulin (CBG), [498–499](#), [498t](#)
corticosteroids, [249](#)
cortisol
 cortisone reduction to, [184–185](#)
 laboratory tests for, [565](#), [567](#)
 plasma transport of, [498–499](#), [498t](#)
 synthesis of, [484f](#), [485f](#), [486](#)
cortisone, cortisol synthesis from, [184–185](#)
cos sites, [436](#)
cosmids, [436–437](#), [437t](#)
cotranslational glycosylation, [581](#)
cotranslational insertion, [582–583](#), [582f](#), [583f](#)
cotranslational pathway, [580–581](#), [581f](#)
cotransport systems, [468](#), [468f](#)
cotransporters, [469](#)
Coulomb's law, [7](#)
coumarin drugs, [677–678](#)
coupled enzyme assays, [63](#), [63f](#)
coupling
 of endergonic and exergonic reactions, [106–107](#), [106f](#), [107f](#), [109](#)
 of oxidation and phosphorylation in respiratory chain, [122–123](#), [123t](#)
covalent bonds
 biomolecule stabilization by, [7](#), [7t](#)
 in collagen, [43](#)
 membrane lipid-protein interaction and, [463](#)
covalent catalysis
 activation energy lowering by, [72](#)
 enzymatic, [59–61](#), [59f](#), [61f](#), [62f](#)
covalent cross-links, [593](#)
covalent modifications. *See also* phosphorylation

- carcinogens causing, 684
- enzyme regulation by, 85–90, 88*f*, 89*t*
- in glycolysis and gluconeogenesis regulation, 175
- of histones, 351, 353*t*
- mass spectrometry detection of, 28, 28*t*
- in protein posttranslational processing, 42–43
- of pyruvate dehydrogenase, 161–163, 162*f*
- reversibility of, 87

COX-1. *See* cyclooxygenase

COX-2, 224

coxibs, 226

cPLA₂ (cytosolic phospholipase A₂), 670, 671*f*

CPT-I. *See* carnitine palmitoyltransferase-I

CPT-II. *See* carnitine palmitoyltransferase-II

C-reactive protein (CRP), 630, 630*t*

creatine, biosynthesis of, 301, 302*f*

creatine kinase, 620

- in creatine phosphate shuttle, 126, 126*f*
- diagnostic use of, 64, 64*t*
- mitochondrial compartmentalization of, 118

creatine phosphate

- in energy conservation and capture, 108, 109*f*
- in muscle contraction, 620, 620*f*

creatine phosphate shuttle, 126, 126*f*

creatinine

- biosynthesis of, 301, 302*f*
- laboratory tests for, 566

creatinine clearance, 455

CREB (cyclic AMP response element binding protein), 505

CREB-binding protein (CBP), 513–514, 514*t*

Creutzfeldt-Jakob disease (CJD), 42

Crigler-Najjar syndrome, 314

CRISPR-Cas, 348

CRISPR-Cas9, 434*t*, 435, 435*f*, 446–447

cro gene, 415, 415*f*

Cro protein, 415–416, 416*f*

Crohn disease, 226

cross-bridge complex, 616, 616f
crossing-over, in chromosomal recombination, 359, 359f, 360f
crotonyl-CoA, lysine formation of, 286, 288f
CRP (C-reactive protein), 630, 630t
cryo-electron microscopy, protein structures solved by, 40
crystallography, protein structures solved by, 39–40
CTD (carboxy-terminal domain), 383–384, 415
C-terminal binding domain, 37
CTP (cytidine triphosphate), 86, 323
cubilin, 101
cutaneous porphyrias, 310t, 311
cyanide, respiratory chain inhibition by, 112, 118, 123
cyclic 3',5'-nucleotide phosphodiesterase, in lipolysis, 246
cyclic AMP (cAMP), 322, 323f, 324t
 adenylyl cyclase and, 503–504, 503t
 formation and hydrolysis of, 167, 168f
 glycogen regulation by, 166–170, 168f, 169f, 170f, 171f
 in hemostasis and thrombosis, 672
 in muscle contraction, 619
 in operon model, 414
 phosphodiesterases and, 505
 phosphoprotein phosphatases and, 505–506
 phosphoproteins and, 505
 protein kinases and, 504–505, 505f
 as second messenger, 482, 483t, 502
cyclic AMP regulatory protein (catabolite gene activator protein), 412
cyclic AMP response element binding protein activator protein (CREB),
 505
cyclic AMP-dependent protein kinase, in lipolysis, 246, 246f
cyclic GMP (cGMP), 323f
 as second messenger, 323, 483, 483t, 502, 506
 synthesis of, 506
cyclin-dependent kinases (CDKs)
 in cancer, 691
 in cell cycle, 368, 369f, 369t
 inhibition of, 372
cyclins, 368–369, 369f, 369t

in cancer, 691
cycloheximide, 407
cyclooxygenase (COX-1), 224–225
inhibition of, 672
cyclooxygenase pathway, 224–225, 225f, 226f
cyclophilins. *See* proline-*cis*, *trans*-isomerases
cyclosporine, 42
CYP2A6, 557
CYP2C9, 557
CYP27A1 (sterol 27-hydroxylase), 255–256, 256f
cystathionine β -synthase, 285, 300
cysteine, 16t
carbon skeleton catabolism of, 283–285, 284f
specialized products of, 297, 297f
synthesis of, 265, 267f
cysteine sulfinic pathway, 283, 284f
cystic fibrosis (CF), 64, 478, 478t, 519, 585t
cystic fibrosis transmembrane regulator protein, 478
degradation of, 585
cystine, carbon skeleton catabolism of, 283–285, 284f
cystine reductase, 283, 284f
cystinosis, 285
cystinuria, 283
cytarabine, 325, 325f
cytidine, 321f, 322t, 333
cytidine monophosphate (CMP), 322t
cytidine triphosphate (CTP), 86, 323
cytochrome *aa*₃, 112
cytochrome *b*₅, 115, 557, 583, 649
cytochrome *b*₅ reductase, 649
cytochrome *b*₅₅₈, 660
cytochrome *b*_H, in respiratory chain, 120, 121f
cytochrome *b*_L, in respiratory chain, 120, 121f
cytochrome *c*
in apoptosis, 694
iron in, 95–96

in respiratory chain, [118](#), [119f](#), [120](#), [120f](#), [121f](#)
cytochrome *c* oxidase (Complex IV), [118](#), [119f](#), [120–121](#), [120f](#)
deficiency of, [126](#)
cytochrome *c*₁, in respiratory chain, [120](#), [121f](#)
cytochrome oxidase, [112](#)
transition metals in, [97](#)
cytochrome P450 side chain cleavage enzyme (P450scc), [485](#), [485f](#)
cytochrome P450 system, [111](#)
carcinogen activation by, [684](#)
in drug metabolism, [115–116](#), [115f](#), [116f](#), [556–558](#)
inducible nature of, [557–558](#)
iron in, [97](#)
membrane insertion, [583](#)
microsomal ethanol oxidizing system, [244](#)
as monooxygenases, [115–116](#), [115f](#), [116f](#)
nomenclature of, [557](#)
polymorphism of, [557](#)
sterol 27-hydroxylase, [255](#)
xenobiotic hydroxylation by, [556–558](#)
cytochromes, as dehydrogenases, [114](#)
cytokines, [631](#), [638](#), [647](#), [662](#)
advanced glycation end-product activation of, [553](#)
blood glucose regulation by, [179–180](#)
cachexia resulting from, [139](#), [525](#)
in cancer development, [700](#)
cytoplasmic protein tyrosine kinases, [508–509](#), [510f](#)
cytosine, [322t](#), [337f](#)
base pairing in DNA, [339](#), [340f](#)
base pairing in RNA, [342](#), [343f](#)
deoxyribonucleosides of, in pyrimidine synthesis, [332–333](#)
salvage pathways of, [333](#)
cytoskeleton
biomedical importance of, [611](#)
cellular functions of, [623–625](#), [624f](#), [625t](#)
cytosol
fatty acid synthesis in, [207](#)
glycolysis in, [134](#), [134f](#)

lipogenesis in, 216–220, 219*f*, 221, 221*f*
pentose phosphate pathway in, 182–183
pyrimidine synthesis in, 332
cytosolic branch, of protein sorting, 574*f*
 in cell nucleus, 575*f*, 576–579, 577*t*, 578*f*
 in mitochondria, 576, 577*f*, 577*t*
 in peroxisomes, 579, 579*f*
 signals in, 574–575
cytosolic dynein, 625
cytosolic phospholipase A₂ (cPLA₂), 670, 671*f*
cytotoxic T cells, 656, 662
cytotoxicity, of xenobiotics, 559, 559*f*

D

D arm of tRNA, 346*f*, 347, 396, 396*f*
D cyclins
 cancer and, 369
 in cell cycle, 368–369, 369*f*, 369*t*
DAG. *See* diacylglycerol; 1,2-diacylglycerol
damage repair mediators, 370, 371*f*
dAMP, 322*f*
dantrolene, 618
DBDs. *See* DNA-binding domains
DBH (dopamine β-hydroxylase), 491, 491*f*
DCA (dichloroacetate), 696, 698*t*
Dcytb (duodenal cytochrome b), 101, 632
deacetylases, 89
deacetylation, enzyme regulation by, 88–89
deacylase (thioesterase), 218, 218*f*, 219*f*
deamination, 131
 of amino acids, 133
 citric acid cycle role in, 153–154, 154*f*
 in nitrogen metabolism, 273–274, 274*f*
death receptor pathway, of apoptosis, 692–694, 693*f*
debranching enzyme, in glycogenolysis, 166, 166*f*
decarboxylation, oxidative. *See* oxidative decarboxylation
decay accelerating factor, 554

decitabine, 690
decondensation, 661
defensins, 660*t*
degeneracy, of genetic code, 394, 394*t*
dehydratase, 219*f*
7-dehydrocholesterol, 530, 531*f*
dehydroepiandrosterone pathway, 487, 488*f*
dehydrogenases
 coupled enzyme assays using, 63, 63*f*
 cytochromes as, 114
 detection of NAD(P)⁺-dependent, 63, 63*f*
 flavin groups in, 114
 nicotinamide coenzymes of, 113, 113*f*
 oxidation–reduction reactions of, 112–114, 113*f*
dehydrogenation, hydrogenation coupling to, 106, 107*f*
denaturation
 DNA structure analysis and, 340–341
 protein refolding after, 41
 temperature increases causing, 72
dense granules, 654
deoxy sugars, 145, 145*f*
deoxyadenylate, 338–339
deoxycholic acid, synthesis of, 255
deoxycytidine residues, methylation of, 418–419
deoxycytidylate, 338–339
2-deoxy-D-glucose, 696, 698*t*
2-deoxy-D-ribose, 320
deoxyguanylate, 338–339
deoxynucleotides, 338–340, 339*f*
deoxyribonucleases (DNase), 348
 active chromatin and, 353
deoxyribonucleic acid. *See* DNA
deoxyribonucleoside diphosphates (dNDPs), 332, 332*f*
deoxyribonucleosides, 320, 332–333
deoxyribose, 141, 145, 145*f*
3-deoxyuridine, 324
dephosphorylation, enzyme regulation by, 87–90, 88*f*, 89*t*

depolarization, in nerve impulse transmission, 473
depolarization, nonpolar lipids and, 196
derepressed systems, 410
dermatan sulfate, 599, 601*f*, 602*t*, 603
 Δ^9 -desaturase, 97, 223–224, 223*f*
desmosines, 596
desmosomes, 466
desmosterol, in cholesterol synthesis, 250, 252*f*
detergents, 462
detoxification, cytochrome P450 roles in, 115–116, 115*f*, 116*f*, 556–558
developmental biology, 717
dexamethasone suppression test, 567
dextrans, 146
dextrose, 143
DGAT (diacylglycerol acyltransferase), 230, 231*f*
DHA (docosahexaenoic acid), 199, 224
DHT. *See* dihydrotestosterone
diabetes insipidus, nephrogenic, 472
diabetes mellitus, 585*t*
 advanced glycation end-products in, 553, 553*f*
 case study, 719–720, 725–726
 excessive gluconeogenesis in, 172
 fatty liver and, 244
 free fatty acid levels in, 238
 glucose tolerance in, 180–181, 180*f*
 glycated hemoglobin in management of, 55, 553
 insulin impairments in, 130, 140
 ketosis/ketoacidosis in, 215
 lipid transport and storage disorders, 236–237
 lipids and, 196, 198
 lipogenesis and, 216, 220
 respiratory chain disorders in, 126
diabetic cataract, 190–191
diacylglycerol (DAG), 200, 658
 formation of, 230*f*, 234*f*
 protein kinase C and, 507, 507*f*
1,2-diacylglycerol (DAG), in platelet aggregation, 670, 671*f*

diacylglycerol acyltransferase (DGAT), 230, 231f
diagnostic enzymology, 63–65, 64t, 65f, 564–565, 564f
diagnostic testing. *See* laboratory tests
 α,γ -diaminobutyric acid, 18, 18t
Diamond-Blackfan anemia, 649
diapedesis, 657, 657f
diarrhea, 474, 555
diazanorleucine, 328, 329f
dicarboxylic aciduria, 215
dicer nuclease-TRBP complex, 391
dichloroacetate (DCA), 696, 698t
dicopper center, 99–100, 99f
dicumarol, 532
dielectric constant, 7
diet
 amino acids obtained only through, 14, 131, 264, 264t, 526
 biomedical importance of, 519
 blood glucose derived from, 177–178, 178f
 cholesterol levels affected by, 250, 254, 257
 hepatic VLDL secretion and, 242–243, 243f
 high fructose, 186, 188f, 189–190
 high-fat, fatty liver and, 244
 low carbohydrate, 181
 multiple deficiency states in, 527
 requirements
 energy, 129–130, 524–525, 524f
 protein and amino acid, 525–526
 transition metals, 93, 93t
 vitamins and minerals, 527–528
diethylenetriaminepentaacetate (DTPA), 204
diet-induced thermogenesis, 524
diffusion
 facilitated. *See* facilitated diffusion
 net, 468
 simple, 467–468, 467f, 467t, 468f
diffusion-limited enzymes, 75
digestion

biomedical importance of, 519
of carbohydrates, 520, 520*f*
of lipids, 520–521, 522*f*
metabolism of major products of, 130–131, 130*f*, 131*f*, 132*f*
protease activation in, 87
of proteins, 521, 523
of vitamins and minerals, 523–524, 523*f*
digitalis, 473
dihydrobiopterin reductase, 286, 288*f*
dihydrofolate, methotrexate and, 333–334
dihydrofolate reductase, 537
dihydrolipoyl dehydrogenase, 114, 161, 162*f*
dihydrolipoyl transacetylase, 161, 162*f*
dihydroorotic acid, 333*f*
dihydropyridine receptor, 618, 618*f*
dihydropyrimidine dehydrogenase deficiency, 327, 335–336, 336*t*, 337*f*
dihydrotestosterone (DHT), 483
 plasma transport of, 498*t*, 499
 synthesis of, 487, 489*f*
dihydroxyacetone phosphate, in glycolysis, 159, 159*f*, 230, 231*f*, 232*f*
1,25-dihydroxyvitamin D, 530–531, 531*f*
diiodotyrosine (DIT), 492, 493*f*
diiron center, of hemerythrin, 97, 97*f*
dilated cardiomyopathy, 622
dimercaprol, 123
dimeric proteins, 38
dimers
 Cro protein, 415, 416*f*
 histone, 351, 351*f*, 353
 lambda repressor (cI) protein, 415, 416*f*
dimethylallyl diphosphate, in cholesterol synthesis, 250, 251*f*
dimethylaminoadenine, 323*f*
2,4-dinitrophenol, 123
dinucleotide, 325
dioxygenase, 115
dipalmitoyl lecithin, 200, 229
dipeptidases, 521

diphosphomevalonate decarboxylase, [251f](#)
diphosphomevalonate kinase, [251f](#)
diphtheria toxin, [407](#), [472](#)
dipoles, [6–7](#), [7f](#)
dipsticks, [565](#)
direct bilirubin, [313](#)
disaccharidases, [520](#)
disaccharides, [142](#)
 digestion of, [520](#), [520f](#)
 of physiological importance, [145](#), [146f](#), [146t](#)
disease
 autoimmune, [627](#), [628t](#)
 biochemical processes underlying, [3](#)
 biochemistry interrelationship with, [2](#), [2f](#)
 conformational, [585t](#)
 of DNA damage repair, [369](#), [370t](#)
 genetic. *See* genetic diseases
 membranes and, [459](#), [478t](#)
 molecular analysis of, [442–445](#), [443f](#), [444f](#), [444t](#)
 protein sorting and, [573](#)
 proteoglycans and, [604](#)
 red blood cells and, [646](#), [650t](#)
 of skin, [3](#)
diseases of proteostasis deficiency, [590](#)
dislocation, [584](#)
dispensable amino acids, [131](#)
dissociation, [9–12](#)
dissociation constant (K_d)
 definition of, [9](#)
 Michaelis constant as approximation of, [75–76](#)
 of water, [10](#)
 of weak acids and bases, [11](#)
disulfide bonds
 in chemokines, [658](#), [658f](#)
 formation of, [41–42](#)
 in protein tertiary and quaternary structures, [39](#)
DIT (diiodotyrosine), [492](#), [493f](#)

diurnal variation, in cholesterol synthesis, [252](#)
divalent metal ion transport protein (DMT-1), [101](#)
divalent metal transporter, [632](#), [632f](#)
Dixon plot, [78](#), [78f](#)
DMT-1 (divalent metal ion transport protein), [101](#)
DNA
 base pairing in, [339](#), [340f](#)
 matching of for renaturation, [341](#)
 biomedical importance of, [338](#)
 carcinogen reactions with, [684](#)
 in chromatin, [352f](#)
 chromosomal, [352f](#), [355–356](#), [355f](#), [355t](#), [356f](#)
 cloning of, [435–438](#), [436f](#), [437f](#), [437t](#)
 coding regions of, [355–356](#), [357f](#)
 complementarity of, [341](#), [341f](#), [438](#)
 damage to
 double-strand break, [370](#), [370f](#), [371f](#)
 types of, [369](#), [370t](#)
 double-helix structure of, [8](#), [339–340](#), [340f](#)
 enhancer elements, [420–422](#), [422f](#), [422t](#), [423f](#)
 epigenetic code of, [384](#)
 free radical damage to, [541–542](#), [542f](#)
 genetic information contained in, [338–341](#)
 in genetic information flow, [393–394](#)
 immunoglobulin in rearrangements of, [361](#)
 integrity monitoring of, [372](#)
 mitochondrial, [358–359](#), [358f](#), [359t](#)
 mutations in, [350–351](#), [359–361](#). *See also* mutations, genetic
 noncovalent interactions in, [8](#)
 in nucleosomes, [351](#), [351f](#), [352f](#), [353](#)
 partial digestion of, [438](#)
 as polynucleotides, [325](#)
 protein identification using, [28](#)
 recombinant. *See* recombinant DNA
 relationship to mRNA, [357f](#)
 relaxed form of, [341](#)
 renaturation of, base pair matching and, [341](#)

repair of, 585
 study of, 369–372
 types of, 369–370, 370*f*, 370*t*

repetitive-sequence, 357

replication and synthesis of, 341, 342*f*
 biomedical importance of, 350–351
 control of, 361–362, 362*f*, 362*t*
 DNA polymerase complex in, 362*f*, 363, 363*t*
 epigenetic signals during, 419, 420*f*
 initiation of, 363–364, 365*f*, 366*f*
 origin of, 362–363, 362*f*
 polarity of, 364, 366*f*
 reconstitution of chromatin structure in, 368
 repair during, 369–370, 370*t*
 replication bubble formation and, 364, 366*f*, 367–368, 367*f*
 replication fork formation and, 362*f*, 363, 366*f*
 ribonucleoside diphosphate reduction and, 332
 RNA primer in, 362*f*, 362*t*, 363–364, 365*f*, 366*f*
 RNA synthesis compared with, 375
 in S phase of cell cycle, 368–369, 368*f*, 368*t*, 369*f*, 369*t*
 semiconservative nature of, 341, 342*f*
 semidiscontinuous, 362*f*, 364, 366*f*
 steps in, 362*f*, 362*t*
 unwinding of, 363

restriction enzyme cleavage of, 433–434, 433*t*, 434*f*, 434*t*
in RNA synthesis. *See* RNA, synthesis of

sequencing of, 439, 440*f*
 direct, 445–446

silencer elements, 422–423

structure of
 components of, 338–339, 339*f*
 denaturation in analysis of, 340–341
 double-helical, 339–340, 340*f*
 forms of, 341
 grooves in, 340*f*, 341

supercoiled, 341, 367, 368*f*

topoisomerases of, 341

transcription of, [341](#). *See also* RNA, synthesis of
transposition of, [360](#), [442](#)
unique-sequence (nonrepetitive), [357](#)
unwinding of, [378](#)
xenobiotic reactions with, [559](#), [559f](#)

DNA blot transfer procedure, [438](#), [439f](#)

DNA chips, [31](#)

DNA damage sensors, [370](#), [371f](#)

DNA elements
combinations of, [424](#), [425f](#)
gene expression enhancement and repression by, [420–423](#), [422f](#), [422t](#),
[423f](#)
locus control regions and insulators, [424–425](#)
reporter genes and, [423](#), [424f](#)
tissue-specific expression of, [423](#)

DNA helicase, [362f](#), [363](#), [363t](#)

DNA lesions, [712](#)

DNA ligase, [363t](#), [364](#)
in chimeric DNA molecule preparation, [434–435](#)
in recombinant DNA technology, [434t](#)

DNA methylases, sequence-specific, [433](#)

DNA methyltransferases (DNMTs), inhibitors of, [690](#)

DNA polymerases
prokaryotic and eukaryotic, [364t](#)
in recombinant DNA technology, [434t](#), [440](#), [441f](#)
in replication, [362f](#), [363](#), [363t](#)

DNA primase, [362f](#), [363t](#)

DNA regulatory elements, [422](#), [423f](#)

DNA repair mechanism, [559](#)

DNA topoisomerases, [367](#), [367f](#)

DNA transfection, endocytosis in, [474](#)

DNA unwinding element (DUE), [362–363](#)

DNA-binding domains (DBDs), [381](#)
of cI repressor protein, [415](#)
of regulatory transcription factor proteins, [425t](#)
helix-turn-helix motif, [425–426](#), [426f](#)
leucine zipper motif, [427](#), [427f](#)

- zinc finger motif, [426](#), [426f](#)
- transactivation domain separation from, [427–428](#), [428f](#)
- DNA-dependent protein kinase (DNA-PK), [370](#), [371f](#)
- DNA-dependent RNA polymerases
 - initiation by, [375–377](#), [376f](#), [377f](#)
 - in operon model, [412](#), [413f](#), [414](#)
- DNA-PK (DNA-dependent protein kinase), [370](#), [371f](#)
- DNA-protein interactions
 - bacteriophage lambda as paradigm for, [414–418](#), [414f](#), [415f](#), [416f](#), [417f](#)
 - mapping of, [446–447](#)
- DNase. *See* deoxyribonucleases
- DNase I
 - active chromatin and, [353](#)
 - in recombinant DNA technology, [434t](#)
- dNDPs (deoxyribonucleoside diphosphates), [332](#), [332f](#)
- DNMTs (DNA methyltransferases), inhibitors of, [690](#)
- docking, in protein sorting, [578](#), [586–587](#)
- docosahexaenoic acid (DHA), [199](#), [224](#)
- dolichol, [203](#), [204f](#)
 - in cholesterol synthesis, [250–251](#), [251f](#)
- dolichol pyrophosphate, in glycoprotein synthesis, [550–551](#), [551f](#)
- domains
 - albumin, [630](#)
 - chromatin, [352f](#), [353](#), [355](#)
 - DNA-binding. *See* DNA-binding domains
 - of hormone receptors, [481–482](#)
 - protein, [37](#), [38f](#), [39f](#)
- L-dopa, [491](#), [491f](#)
- dopa decarboxylase, in catecholamine biosynthesis, [491](#), [491f](#)
- dopamine, [491](#), [491f](#). *See also* catecholamines
- dopamine β -hydroxylase
 - copper in, [98–100](#)
 - vitamin C as coenzyme for, [539](#)
- dopamine β -hydroxylase (DBH), [491](#), [491f](#)
- double displacement reactions, [79](#), [79f](#)
- double helix, of DNA structure, [8](#), [339–340](#), [340f](#)
- double membrane, of mitochondria, [118](#), [118f](#)

double negative, [410](#)
double reciprocal plot, [74–75](#), [75f](#)
 for Bi-Bi reactions, [79](#), [80f](#)
 inhibitor evaluation with, [77](#), [77f](#), [78f](#)
double-strand breaks (DSBs), [370](#), [370f](#), [371f](#)
double-stranded DNA (dsDNA), [339–340](#), [351](#), [361](#), [375](#)
downstream promoter element (DPE), [380](#)
DPE (downstream promoter element), [380](#)
driver mutations, [701](#), [703](#)
Drosha-DGCR8 nuclease, [390–391](#)
drug development
 enzyme kinetics role in, [80](#)
 high-throughput screening for, [62–63](#)
 rate-limiting enzymes as targets of, [84](#)
 RNA targets for, [348](#)
 suicide inhibitors in, [78–79](#)
 telomerase as target for, [355](#)
drug interactions, cytochrome P450 role in, [557](#)
drug metabolism, [80](#)
 acetylation and methylation, [558–559](#)
 conjugation, [558](#)
 cytochrome P450 role in, [115–116](#), [115f](#), [116f](#), [556–558](#)
 hydroxylation, [556–558](#)
drug resistance, [429](#)
 in cancer, [702–703](#), [702t](#)
drug-induced porphyria, [311](#)
dry chemistry dipsticks, [565](#)
DSBs (double-strand breaks), [370](#), [370f](#), [371f](#)
dsDNA (double-stranded DNA), [339–340](#), [351](#), [361](#), [375](#)
DTPA (diethylenetriaminepentaacetate), [204](#)
dual-function proteins, [487](#)
Dubin-Johnson syndrome, [315](#)
Duchenne muscular dystrophy, [622](#)
Duchenne-type muscular dystrophy, [445](#)
DUE (DNA unwinding element), [362–363](#)
duodenal cytochrome b (Dcytb), [101](#), [632](#)
dynamin, [475](#), [625](#)

dysbetalipoproteinemia, familial, [258t](#)

dyslipoproteinemias, [257](#), [258t](#)

dysplasia

 acromicric, [597](#)

 colorectal, [687–688](#), [688f](#), [688t](#)

 geleophysic, [597](#)

 thanatophoric, [609](#)

α -dystroglycan, [622](#), [623f](#)

dystrophin, [622](#), [623f](#)

E

E. coli, lactose metabolism and operon hypothesis in, 411–412, 411f, 413f, 414

E. coli bacteriophage P1-based (PAC) vector, 437, 437t

E cyclins, 369, 369f, 369t

E (exit) site, of 80S ribosome, 402, 403f

E'_0 . See redox potential

E3 ligases, 84–85

E_{act} . See activation energy

E-cadherin, in cancer, 698, 700t

ECF (extracellular fluid), 460, 460t

ECM. See extracellular matrix

EcoRI, 433, 433t, 436f

EcoRII, 433t

edema

kwashiorkor causing, 525

plasma protein concentration and, 628

vitamin B₁ deficiency in, 534

Edman reaction, protein and peptide sequencing with, 27–28, 27f

Edman reagent, 27, 27f

EDTA (ethylenediaminetetraacetate), 204

EF1A (elongation factor 1A), 402, 403f

EF2 (elongation factor 2), 403, 403f

EFA. See essential fatty acids

effectors, of apoptosis, 692–694, 693f

EFs (elongation factors), 402–403, 403f, 403t

EGF. See epidermal growth factor

Ehlers-Danlos syndrome, 43–44, 264, 592, 595, 595t, 596t

eicosanoids, 16, 197, 198, 224, 225f, 662

eicosapentaenoic acid (EPA), 199, 222f, 224

eIF-1A, in protein synthesis, 399, 400f

eIF-2, in protein synthesis, 399, 400f

eIF-3, in protein synthesis, 399, 400f

eIF-4F complex, in protein synthesis, 399, 400f, 401–402, 401f

eIFs, in protein synthesis, 399, 400f

elaidic acid, [197t](#), [198](#), [198f](#)
elastase, [521](#)
 covalent catalysis of, [61](#)
elastic cartilage, [607–608](#), [608t](#)
elastin, [596](#), [597t](#), [607](#)
electric potential, [576](#)
electrical insulators
 myelin sheets as, [473](#)
 nonpolar lipids as, [196](#)
electrogenic effect, [473](#)
electrolytes
 lipid bilayer and, [462](#)
 measurement of, [564](#)
electron microscopy (EM), protein structures solved by, [40](#)
electron movement, in active transport, [472](#)
electron transport, in respiratory chain, [118](#), [119f](#), [120–121](#), [120f](#), [122f](#)
electron-transferring flavoprotein (ETF), [114](#)
electrophiles, [8](#)
 carcinogens as, [684](#)
 in enzymatic catalysis, [58](#)
electrophoresis. *See also* gel electrophoresis
 for plasma protein analysis, [628](#)
electrospray ionization, [29–30](#), [30f](#)
electrostatic interactions, [8](#), [340](#)
ELISAs. *See* enzyme-linked immunosorbent assays
elliptocytosis, hereditary, [651](#), [653](#)
elongase, [220](#), [221f](#)
 in polyunsaturated fatty acid synthesis, [223–224](#), [223f](#)
elongation
 in protein synthesis, [402–403](#), [403f](#), [403t](#)
 in proteoglycan synthesis, [600](#)
 in RNA synthesis, [376f](#), [378](#)
elongation arrest, [580](#), [581f](#)
elongation chain, in fatty acid synthesis, [220](#), [221f](#)
elongation factor 1A (EF1A), [402](#), [403f](#)
elongation factor 2 (EF2), [403](#), [403f](#)
elongation factors (EFs), [402–403](#), [403f](#), [403t](#)

EM (electron microscopy), protein structures solved by, [40](#)
emaciation, [130](#)
emphysema, [638](#)
EMT (epithelial-to-mesenchymal transition), [698](#), [699f](#)
emulsions, amphipathic lipids forming, [204–205](#), [205f](#)
encephalopathy
 lactic acidosis with, [118](#)
 vitamin B₁ deficiency in, [534](#)
endergonic reactions, exergonic reaction coupling to, [106–107](#), [106f](#), [107f](#),
 [109](#)
endocrine system. *See also* hormone receptors; hormones
 biomedical importance of, [480](#)
 neural regulation of, [480](#)
endocytosis, [459](#), [467t](#)
 LDL in, [253](#)
 of macromolecules, [474–475](#), [474f](#), [475f](#), [477f](#)
endoglycosidases, [603](#)
endonucleases, [348](#), [433](#). *See also* restriction enzymes
 in chimeric DNA molecule preparation, [434–435](#)
endopeptidases, [521](#)
endoplasmic reticulum (ER), [134](#)
 brefeldin A and, [588](#)
 calnexin in, [551–552](#)
 cytochromes P450 in, [557](#)
 exocytosis in, [475](#)
 fatty acid chain elongation in, [220](#), [221f](#)
 misfolded proteins degradation in, [584–585](#), [585f](#), [585t](#)
 protein attachment to, [583](#)
 protein sorting signals in, [573](#), [574t](#)
 quality control of, [584](#)
 rough. *See* rough endoplasmic reticulum
 signal hypothesis of polyribosome binding to, [574](#), [574f](#), [580–582](#), [580t](#),
 [581f](#), [582f](#)
endoplasmic reticulum-associated degradation (ERAD), [584–585](#), [585f](#),
 [585t](#)
endosymbiosis, [710](#)
endothelial cells

in hemostasis and thrombosis, 670, 672
selectins of, 553–554

endothelium-derived relaxing factor, 622

energy. *See also* bioenergetics; free energy
for active transport, 472, 472*t*
human requirement for, 129–130, 524–525, 524*f*
transduction in membranes, 459

energy balance, 105, 524–525, 524*f*

energy capture, 108

energy conservation, 108

energy expenditure, 524, 524*f*

energy of activation. *See* activation energy

energy-linked transhydrogenase, mitochondrial, 125

enhancer response element, 422*f*

enhancer-binding proteins, 421

enhancers, in gene expression, 410
 β -interferon gene, 422, 423*f*
properties of, 420–422, 422*t*
study of, 420–421, 422*f*
tissue-specific expression of, 423

enolase, in glycolysis, 159, 159*f*

enoyl reductase, 218*f*, 219*f*

Δ^2 -enoyl-CoA hydratase, 209, 209*f*, 210

entactin, 598

enterohepatic circulation, 255–256, 255*f*, 521

enterohepatic urobilinogen cycle, 313

enthalpy, 106

entropy, 106

environmental mutations, 683

enzymatic assays
clinical diagnosis using, 63–65, 64*t*, 65*f*, 564–565, 564*f*
coupled, 63, 63*f*
in drug development, 80
high-throughput screening, 62–63
immunoassays, 63
initial velocity measurements with, 73, 73*f*
single-molecule, 62, 62*f*

- spectrophotometric, 63, 63*f*
- enzyme inhibitors, transition state analogs, 59
- enzyme kinetics
 - activation energy, 69–70, 70*f*, 72
 - allosteric effects, 86
 - balanced chemical equations, 69
 - biomedical importance of, 68–69
 - catalytic constant and catalytic efficiency, 75
 - catalytic lowering of activation energy barriers, 72
 - in drug development, 80
 - equilibrium constant, 69, 71–72
 - free-energy changes, 69–70, 70*f*
 - Hill equation, 76, 76*f*
 - inhibition, 76–79, 77*f*, 78*f*
 - initial velocity, 73–74, 73*f*
 - kinetic order, 71
 - Lineweaver-Burk plots, 74–75, 75*f*, 77, 77*f*, 78*f*, 79, 80*f*
 - Michaelis-Menten equation, 73–76, 73*f*, 75*f*, 79, 80*f*
 - multisubstrate reactions, 79, 79*f*, 80*f*
 - reaction rates. *See* rate of reaction
 - transition states, 69–70, 70*f*
- enzyme-linked immunosorbent assays (ELISAs), 63
 - laboratory tests using, 565
- enzymes
 - active site of, 58–59, 59*f*
 - activity of, 75, 564–565, 564*f*
 - bifunctional, 176
 - biomedical importance of, 56
 - as catalysts, 9, 57, 57*f*
 - classification of, 57
 - clinical diagnosis using, 63–65, 64*t*, 65*f*, 564–565, 564*f*
 - coenzymes of, 57–58, 58*f*
 - cofactors of, 57–58, 58*f*
 - conformational changes of, 60, 60*f*
 - conservation of catalytic residues in, 61
 - degradation of
 - rate of, 270

- regulation of, 84–85
- detection of, 62–63, 62*f*, 63*f*
- digestive, 521
- in DNA repair, 350
- as drug targets, 80
- group transfer reactions of, 9
- half-lives of, 270
- heavy metal inactivation of, 94
- homologous, 61
- inhibitors of. *See* inhibitors
- isozymes, 61–62
- kinetics of. *See* enzyme kinetics
- mechanisms of action of, 56
 - acid–base catalysis, 59–60, 60*f*
 - covalent catalysis, 59–61, 59*f*, 61*f*, 62*f*
 - proximity, 59
 - site-directed mutagenesis in study of, 66
 - strain, 59
- membranes in localization of, 459
- of neutrophils, 659, 660*t*
- nucleases, 348
- prosthetic groups of, 57–58, 58*f*
- rate-limiting, 84
- reactive oxygen species and, 713
- recombinant DNA in studies of, 65–66, 66*f*
- regulation of
 - active or passive, 83, 83*f*
 - allosteric, 85–86, 85*f*, 135–136, 135*f*
 - biomedical importance of, 82–83
 - compartmentation role in, 83–84
 - control networks of, 90, 90*f*
 - covalent modifications in, 85–90, 88*f*, 89*t*
 - hormones in, 86, 135–136, 135*f*
 - multiple mechanisms of, 85
 - proenzymes in, 87–88, 88*f*
 - quantities, 84–85
 - rate-limiting enzymes as targets of, 84

- second messengers in, 86
- regulatory, 135
- replacement therapy for, 235
- RNA, 343
- specificity of, 57, 57f
- synthesis of, regulation of, 84
- enzyme–substrate (ES) complex, stability of, 58
- enzymopathy, 650
- eosinophils, 656, 659, 661, 661f
- EPA (eicosapentaenoic acid), 199, 222f, 224
- epidermal growth factor (EGF)
 - in insulin signal generation, 508, 509f
 - receptor for, 482, 702
- epidermis, 708t
- epidermolysis bullosa, 595t, 596, 625
- epidermolytic palmoplantar keratoderma, 625
- epigenetic code of DNA, 384
- epigenetic mechanisms, control of gene transcription and, 419–420, 420f, 421f
- epigenetic signals, 419, 420f, 421f
- epigenetics, 82
 - in cancer development, 690
 - histone code as, 87
- epimerases, 600
- epimers, 143, 144f
- epinephrine. *See also* catecholamines
 - blood glucose regulation by, 180
 - glycogen regulation by, 167–168, 169f
 - in glycolysis and gluconeogenesis regulation, 175
 - in lipogenesis regulation, 221, 222f
 - synthesis of, 484f, 491f, 492
 - tyrosine conversion to, 300, 302f
- episomes, 436
- epithelial-to-mesenchymal transition (EMT), 698, 699f
- epitopes, 36
- EPO (erythropoietin), 647, 649
- epoxide hydrolase, 559, 559f

epoxides, 559, 559f
eptifibatide, 672
equilibrium
 of chemical reactions, 69
 of nitrogen in healthy humans, 525
equilibrium constant (K_{eq})
 enzymatic effects on, 72
 Gibbs free-energy change and, 69, 106
 as ratio of rate constants, 71–72
ER. *See* endoplasmic reticulum
ERAD (endoplasmic reticulum-associated degradation), 584–585, 585f, 585t
ergosterol, 203, 203f
ergothioneine, 298, 298f
erlotinib, 702
ERp57, 551
erythrocytes. *See also* red blood cells
 in fasting state, 130, 138–139, 138t, 139f, 139t
 in fed state, 130, 136–138, 137f, 138t
 glucose requirement of, 136
 glycolysis in, 161, 161f, 648, 648t
 pentose phosphate pathway and
 glutathione peroxidase in, 185–186, 186f
 impairment in, 188–189
erythromycin, 145
erythropoiesis
 initial stages of, 649
 iron-deficient, 636
erythropoietic porphyrias, 310t, 311
erythropoietin (EPO), 647, 649
erythrose-4-phosphate, in pentose phosphate pathway, 183f, 184f, 185
ES (enzyme-substrate) complex, stability of, 58
Escherichia coli, lactose metabolism in, operon hypothesis and, 411–412, 411f, 413f, 414
Escherichia coli bacteriophage P1-based (PAC) vector, 437, 437t
essential amino acids, 14, 131, 264, 264t, 526
essential fatty acids (EFA), 196, 216

- abnormal metabolism of, 226
- deficiency of, 224–225
- physiologic effects of, 224
- polyunsaturated, 222, 222*f*
- prostaglandin production and, 224

essential fructosuria, 190

essential pentosuria, 182, 189

estradiol, 483, 484*f*, 485*f*, 498*t*, 499

estriol, 487, 489*f*

estrogen receptor modulators, 703

estrogens

- amino acid transport and, 470
- cholesterol levels and, 257
- synthesis of, 487–489, 489*f*, 490*f*

estrone, 487–488, 489*f*, 498*t*, 499

ETF (electron-transferring flavoprotein), 114

ethanol

- cytochrome P450 induction by, 557
- fatty liver and, 244

ethanolamine, 201, 201*f*

ether lipids, biosynthesis of, 232*f*

ethylenediaminetetraacetate (EDTA), 204

euchromatin, 354

eukaryotic gene expression

- alternative RNA processing and, 430
- amplification, 429, 429*f*
- bacteriophage lambda as paradigm for protein-DNA interactions, 414–418, 414*f*, 415*f*, 416*f*, 417*f*
- chromatin template in, 418–419
- DNA enhancer elements and, 420–423, 422*f*, 422*t*, 423*f*
- epigenetic mechanisms, 419–420, 420*f*, 421*f*
- locus control regions and insulators in, 424–425
- methods of, 428, 428*t*
- as model for study, 411
- mRNA stability and, 430, 430*f*
- ncRNA alteration of mRNA function in, 428–429
- prokaryotes compared with, 428–430, 429*f*, 430*f*

- response diversity in, [424](#), [425f](#)
- special features of, [418](#)
- tissue-specific expression of, [423](#)

eukaryotic initiation factors (eIFs), in protein synthesis, [399](#), [400f](#)

eukaryotic promoters, in transcription, [379–381](#), [380f](#), [381f](#), [382f](#), [383](#)

eukaryotic transcription complex, [381f](#)

- components of, [383](#)
- nucleosomes and, [384](#)
- phosphorylation for RNA polymerase II activation, [384](#)
- PIC assembly, [385–386](#), [385f](#)
- RNA polymerase II formation, [383–384](#)
- transcription activators and coregulators in, [384–385](#), [385t](#)

evolution

- lifespan and, [717](#)
- RNA world hypothesis of, [66–67](#)

evolutionary conservation, of catalytic residues, [61](#)

EVs (extracellular vesicles), [476–478](#), [477f](#), [690](#)

exchange diffusion systems, [124](#)

exchange transporters, of mitochondria, [124–126](#), [124f](#), [125f](#), [126f](#)

excitation-response coupling, [459](#)

executioners, of apoptosis, [692–694](#), [693f](#)

exergonic reactions, endergonic reaction coupling to, [106–107](#), [106f](#), [107f](#), [109](#)

exit (E) site, of 80S ribosome, [402](#), [403f](#)

exocytosis, [459](#), [467t](#), [474–475](#), [475f](#), [477f](#), [574](#)

exocytotic (secretory) pathway, [574](#)

exoglycosidases, [603](#)

exons, [356](#), [357f](#)

- description of, [386](#)
- processing of, [387f](#), [393–394](#)
- splicing of, [386–388](#), [387f](#), [388f](#)

exonucleases, [348](#), [433](#)

- in recombinant DNA technology, [434t](#)

exopeptidases, [521](#)

exosomes, [476–478](#), [477f](#)

- cancer and, [690](#)

exportins, [578](#)

expression vector, [438](#)
extra arm, of tRNA, [346f](#), [347](#)
extracellular environment, membranes in maintenance of, [460](#), [460t](#)
extracellular fluid (ECF), [460](#), [460t](#)
extracellular matrix (ECM). *See also* bone
 aging process and, [592](#)
 biomedical importance of, [592](#)
 collagen. *See* collagen
 elastin, [596](#), [597t](#)
 fibrillins, [597](#), [597f](#)
 fibronectin, [595](#), [597–598](#), [598f](#)
 glycosaminoglycans. *See* glycosaminoglycans
 laminin, [598–599](#), [599f](#)
 proteoglycans. *See* proteoglycans
extracellular vesicles (EVs), [476–478](#), [477f](#), [690](#)
extramitochondrial system, fatty acid synthesis in, [216](#)
extravasation, of cancer cells, [698](#), [699f](#)
extrinsic pathway, [672–673](#), [672f](#), [673f](#), [673t](#), [674t](#)
extrinsic tenase complex, [673](#)
ezetimibe, for hypercholesterolemia, [257](#)

F

FAB (fast atom bombardment), [29–30](#), [30f](#)
Fabry disease, [235t](#)
facilitated diffusion, [467–468](#), [467f](#), [467t](#)
 for glucose. *See* glucose transporters
 hormone regulation of, [469–470](#)
 ping-pong mechanism of, [469](#), [469f](#)
 transporters involved in, [468–469](#), [468f](#), [468t](#), [469f](#)
facilitated transport, of bilirubin, [312](#)
FACITs (fibril-associated collagens with interrupted triple helices), [594](#)
factor I. *See* fibrinogen
factor II. *See* prothrombin
factor III. *See* tissue factor
factor IX, [673t](#), [674](#), [674t](#)
 coumarin drugs and, [677–678](#)
 deficiency of, [678](#)

factor V, [673t](#), [674t](#), [675](#), [675f](#)
factor V Leiden, [677](#)
factor VII, [673](#), [673t](#), [674t](#), [677–678](#)
factor VIII, [673t](#), [674](#), [674t](#)
 deficiency of, [678](#)
factor X, [673t](#), [674t](#)
 coumarin drugs and, [677–678](#)
 extrinsic pathway activation of, [672–673](#), [672f](#), [673f](#)
 intrinsic pathway activation of, [672–674](#), [672f](#), [673f](#)
 prothrombin activation by, [674–675](#), [675f](#)
factor XI, [673t](#), [674](#), [674t](#)
factor XII, [673t](#), [674](#), [674t](#)
factor XIII, [673t](#), [674t](#), [677](#)
facultative heterochromatin, [354](#)
FAD. *See* flavin adenine dinucleotide
FADH₂, fatty acid oxidation generation of, [209](#), [209f](#)
false-positive result, [562](#)
familial amyloidosis, [639](#)
familial hypercholesterolemia (FH), [241](#), [257](#), [258t](#), [478](#), [478t](#), [585t](#)
familial hypertrophic cardiomyopathy, [622](#)
Farber disease, [235t](#)
farnesoid X receptor (FXR), [256](#), [513t](#)
farnesyl diphosphate, in cholesterol/polyisoprenoid synthesis, [250–251](#),
 [251f](#)
fast atom bombardment (FAB), [29–30](#), [30f](#)
fast twitch fibers, [621](#)
fasting state, metabolic fuels in, [130](#), [138–139](#), [138t](#), [139f](#), [139t](#)
fatal infantile mitochondrial myopathy and renal dysfunction, [126](#)
fatigue, glycolysis defects causing, [157](#)
fats, [138t](#), [196](#). *See also* lipids
fatty acid chains, elongation of, [220](#), [221f](#)
fatty acid elongase system, [220](#), [221f](#), [223–224](#), [223f](#)
fatty acid oxidase, [209](#), [209f](#)
fatty acid synthase complex, [217–218](#), [217f](#), [218f](#), [219f](#), [222](#)
fatty acid synthesis
 biomedical importance of, [216](#)
 citric acid cycle role in, [153–155](#), [155f](#)

- in cytosol, [216–220](#), [217f](#), [218f](#)
- extramitochondrial, [216](#)
- fructose effects on, [186](#), [188f](#), [189–190](#)
- fatty acid synthetase, [75](#)
- fatty acid transport protein, membrane, [238](#)
- fatty acid–binding protein, [208](#), [238](#)
- fatty acids
 - absorption of, [521](#)
 - activation of, [208](#), [208f](#)
 - anti-inflammatory, [199](#)
 - eicosanoids formed from, [224](#), [225f](#)
 - essential. *See* essential fatty acids
 - free. *See* free fatty acids
 - for health maintenance, [3](#)
 - long-chain ω 3, [196](#), [199](#)
 - in membranes, [461](#), [461f](#)
 - as metabolic fuel, [130](#), [136](#)
 - metabolic pathways of, [130–131](#), [130f](#), [131f](#)
 - in fasting state, [138](#), [138t](#)
 - in fed state, [137–138](#), [137f](#), [138t](#)
 - at tissue and organ levels, [132–133](#), [133f](#)
 - monounsaturated. *See* monounsaturated fatty acids
 - nomenclature of, [196](#), [196f](#)
 - oxidation of. *See also* ketogenesis
 - acetyl-CoA release and, [208–210](#), [208f](#), [209f](#), [210t](#)
 - biomedical importance of, [207](#)
 - clinical aspects of, [214–215](#)
 - hypoglycemia caused by impairment of, [214–215](#)
 - impairment of, [214–215](#)
 - physical/physiologic properties of, [198–199](#)
 - polyunsaturated. *See* polyunsaturated fatty acids
 - saturated, [196](#), [196f](#), [197](#), [197t](#). *See also* saturated fatty acids
 - trans, [198](#), [226](#)
 - transport of, carnitine in, [208](#), [208f](#)
 - triacylglycerols as storage form of, [199](#), [199f](#)
 - unsaturated. *See* unsaturated fatty acids
- fatty liver

- alcoholism and, 244
- nonalcoholic fatty liver disease, 243
- nonalcoholic steatohepatitis, 243
- of pregnancy, 215
- triacylglycerol metabolism imbalance and, 243–244
- types of, 244

favism, 189

fed state, metabolic fuels in, 130, 136–138, 137*f*, 138*t*

feedback inhibition, of enzymes, 85–86, 85*f*, 89

feedback regulation, 86, 89, 136

- of thrombin, 677

Fenton reaction, 633, 633*f*

fermentation, by cell-free extract of yeast, 1–2

ferric iron

- in heme, 53–54, 95–96
- from heme catabolism, 311

ferritin, 405, 523, 523*f*, 632–633, 632*t*, 634–635, 635*f*

ferrochelatase, 307, 308*f*, 309*f*, 310*t*

ferroportin, 632, 635

ferrous iron, in heme, 48–49, 48*f*, 49*f*, 95–96

fertilization, glycoprotein role in, 553

Fe-S clusters, 97–98, 98*f*

Fe-S (iron-sulfur) proteins, in respiratory chain complexes, 118–120, 119*f*

fetal hemoglobin (HbF), 50–51, 51*f*, 53

α -fetoprotein, 630*t*

FFAs. *See* free fatty acids

FGFR3 (fibroblast growth factor receptor 3), 609

FH (familial hypercholesterolemia), 241, 257, 258*t*, 478, 478*t*, 585*t*

fibril-associated collagens with interrupted triple helices (FACITs), 594

fibrillins, 597, 597*f*

fibrils, 593–594, 594*f*, 607

fibrin, 670

fibrin clot formation

- amplification in, 677
- extrinsic pathway, 672–673, 672*f*, 673*f*, 673*t*, 674*t*
- fibrinogen conversion to fibrin, 675–677, 675*f*, 676*f*
- inherited deficiencies of, 678

- intrinsic pathway, 672–674, 672*f*, 673*f*, 673*t*, 674*t*
- plasmin dissolution of, 678–679, 678*f*
- prothrombin conversion to thrombin, 674–675, 675*f*
- fibrin deposits, 670
- fibrin monomer, 677
- fibrinogen (factor I), 627, 628, 629*f*, 672, 673*t*, 674*t*
 - conversion to fibrin, 675–677, 675*f*, 676*f*
 - in platelet aggregation, 670, 671*f*
- fibrinolysis, 678–679, 678*f*
 - intrinsic pathway in, 674
- fibrinopeptide A (FPA), 676–677, 676*f*
- fibrinopeptide B (FPB), 676–677, 676*f*
- fibroblast growth factor receptor 3 (FGFR3), 609
- fibroblasts, pinocytosis by, 475
- fibroelastic cartilage, 607–608, 608*t*
- fibronectin, 595, 597–598, 598*f*
- fibrous proteins, 34
 - collagen as, 43
- finasteride, 703
- first law of thermodynamics, 105–106
- first-order rate constant, 71
- FISH (fluorescence in situ hybridization), 441
- fish-eye disease, 258*t*
- flame photometry, laboratory tests using, 564
- flavin adenine dinucleotide (FAD), 324*t*
 - in citric acid cycle, 152*f*, 153
 - in cytochromes P450, 115, 115*f*
 - in dehydrogenases, 114
 - in oxidases, 112, 113*f*
 - in respiratory chain complexes, 118
 - vitamin B₂ in synthesis of, 534
- flavin mononucleotide (FMN)
 - in cytochromes P450, 115, 115*f*
 - in dehydrogenases, 114
 - in oxidases, 112, 113*f*
 - in respiratory chain complexes, 118

- vitamin B₂ in synthesis of, 534
- flavoproteins
 - cytochromes P450, 115, 115*f*
 - dehydrogenases, 114
 - oxidases, 112, 113*f*
 - in respiratory chain complexes, 118
- FLIP, in apoptosis, 693*f*, 694
- flip-flop, phospholipid, membrane asymmetry and, 464
- flippases, 464
- fluid mosaic model, 465–466, 466*f*
- fluidity, membrane, 465–466
- fluid-phase pinocytosis, 474–475, 474*f*
- fluorescence, of porphyrins, 308, 310*f*
- fluorescence in situ hybridization (FISH), 441
- fluorescence spectrophotometry, laboratory tests using, 563–564
- fluoride, enolase inhibition by, 159, 159*f*
- 1-fluoro-2,4-dinitrobenzene, 27
- fluoroacetate, 151, 152*f*
- 5-fluorouracil, 80, 324, 324*f*, 334, 336*t*
- fluvastatin, 257
- flux, metabolite, 83, 83*f*, 89, 135–136, 135*f*
- flux-generating reactions, of metabolic pathways, 135
- FMN. *See* flavin mononucleotide
- folate trap, 536*f*, 538
- folding
 - protein, 41–42, 42*f*
 - of proteins, calnexin role in, 551–552
- folic acid
 - coenzymes derived from, 58
 - deficiency of, 282, 526*t*, 538
 - functions of, 528*t*, 537, 537*f*
 - inhibition of, 537
 - structure of, 537, 537*f*
 - supplements of, 538
 - toxicity of, 538
- forensic medicine, 445
- four-helix bundle, 587

Fourier synthesis, [40](#)

FPA (fibrinopeptide A), [676–677](#), [676f](#)

FPB (fibrinopeptide B), [676–677](#), [676f](#)

frameshift mutations, [397–398](#), [398f](#)

free energy

- ATP as cellular currency of, [108–110](#), [108f](#), [109f](#), [121–122](#)
- of ATP hydrolysis, [107–108](#), [107t](#), [108f](#)
- chemical reaction changes in, [69–70](#), [70f](#), [105–106](#)
- enzymatic effects on, [72](#)
- high-energy phosphate capture and transfer of, [107–108](#), [107t](#), [108f](#), [121–122](#)
- metabolic regulation and, [83–84](#), [83f](#)
- obtainment of, [107](#)
- redox potential and, [111–112](#), [112t](#)
- as useful energy in biologic systems, [105–106](#)

free fatty acids (FFAs), [196](#), [207–208](#)

- adipose tissue and, [244](#)
- in fatty liver, [244](#)
- glucose metabolism and, [245](#)
- insulin and, [236](#), [245](#)
- ketogenesis regulation and, [213–214](#), [213f](#), [214f](#)
- lipid mobilization and, [236](#)
- lipogenesis affected by, [220](#), [221f](#)
- in lipoproteins, [237](#), [237t](#)
- metabolism of, [238](#)
- in VLDL formation, [243](#), [243f](#)

free polyribosomes, protein synthesis on, [583](#)

free radical theory of aging, [710](#), [712](#)

free radicals

- antioxidant paradox and, [544–545](#), [544t](#)
- biomedical importance of, [541](#)
- damage caused by, [541–542](#), [542f](#)
- lipid peroxidation producing, [203–204](#), [204f](#)
- mechanisms protecting against, [543–544](#), [544f](#)
- self-perpetuating chain reactions of, [541](#)
- sources of, [542–543](#), [543f](#)
- theory of aging, [710](#), [712](#)

fructokinase, 186, 188*f*, 189
deficiency of, 190

fructose
absorption of, 520, 520*f*
defective metabolism of, 190
in diabetic cataract, 190–191
in glycolysis pathway, 161
ingestion of large quantities of, 186, 188*f*, 189–190
physiological importance of, 144*t*
structure of, 143, 143*f*

fructose 1,6-bisphosphatase
deficiency of, 190
in gluconeogenesis, 173*f*, 174
in pentose phosphate pathway, 183*f*, 184*f*, 185

fructose 1,6-bisphosphate
in gluconeogenesis, 173*f*, 174
in glycolysis, 159, 159*f*

fructose 2,6-bisphosphatase, 176, 177*f*

fructose 2,6-bisphosphate, in glycolysis and gluconeogenesis regulation, 176, 177*f*

fructose-2,6-bisphosphatase, covalent catalysis of, 61, 62*f*

fructose-6-phosphate
in gluconeogenesis, 173*f*, 174
in glycolysis, 159, 159*f*
in pentose phosphate pathway, 183*f*, 184*f*, 185

fructosuria, 190

fucose, 147, 148*f*, 548*t*

fucosyl (Fuc) transferase, 653

fumarase (fumarate hydratase), in citric acid cycle, 152*f*, 153

fumarate
in citric acid cycle, 152*f*, 153
in urea synthesis, 275*f*, 276

fumarylacetoacetate hydrolase, 286, 287*f*

functional groups
of amino acids, 18–20, 19*f*, 20*f*, 20*t*
weak acids acting as, 11–12

furanose ring structures, 143, 143*f*

furin, [588](#), [588f](#)
fusion of vesicles, [588](#)
fusion proteins, [65–66](#), [66f](#)
futile cycles
 in glycolysis and gluconeogenesis regulation, [176–177](#)
 of lipids, [525](#)
FXR (farnesoid X receptor), [256](#), [513t](#)

G

ΔG . *See* Gibbs free-energy change
 ΔG^0 . *See* standard free-energy change
G1 and G2 phase, [368](#), [368f](#), [369f](#)
G6PD. *See* glucose-6-phosphate dehydrogenase
GA. *See* Golgi apparatus
GABA (γ -aminobutyrate), biosynthesis of, [303](#), [303f](#)
GAGs. *See* glycosaminoglycans
Gal transferase, [654](#)
GAL1 enhancer, [427](#), [428f](#)
galactokinase, [187](#), [189f](#)
galactosamine, [145](#), [145f](#)
 synthesis of, [188](#), [190f](#)
galactose, [141](#), [143](#), [144f](#)
 absorption of, [520](#), [520f](#)
 in glycoproteins, [547](#), [548t](#)
 impaired metabolism of, [191](#)
 metabolism of, [187–188](#), [189f](#)
 physiological importance of, [144t](#)
galactose-1-phosphate uridyl transferase, [187](#), [189f](#)
galactosemias, [191](#)
galactoside, [145](#)
galactosyl receptor, [475](#)
galactosylceramide, [202](#), [202f](#), [234](#), [234f](#), [235t](#), [461](#)
gallium, toxicity of, [94](#)
gallstones, [250](#), [519](#)
 hyperbilirubinemia caused by, [313f](#), [313t](#), [314](#)
GalNAc (*N*-acetylgalactosamine), [547](#), [548t](#), [549](#)
GalNAc transferase, [654](#)

γ -rays, carcinogenic effect of, 683, 683t
gangliosides, 202
 amino sugars in, 145, 145f
 in membranes, 461
 synthesis of, 234, 234f
gangliosides., 147
gap 1 and 2 phase, 368, 368f, 369f
gap junctions, 459, 476, 476f
GAPs (GTPase-accelerating proteins), 578
gastroenteropathy, protein-losing, 630
gated ion channels, 471, 471f
gatekeeper tumor suppressor genes, 686–687
Gaucher disease, 235t, 585t
GDF15 (growth differentiation factor 15), 635
GDH. *See* glutamate dehydrogenase
GDP, 587
gefitinib, 702
GEFs (guanine nucleotide exchange factors), 578, 578f
gel electrophoresis
 polyacrylamide gel, 26, 26f
 protein and peptide purification with, 26, 26f
geldanamycin, 590
geleophysic dysplasia, 597
gel-filtration chromatography. *See* size-exclusion chromatography
gemfibrozil, 257
gene amplification, in cancer, 685
gene arrays, 31
gene conversion, 361
gene expression
 constitutive, 411, 414
 miRNA and siRNA inhibition of, 348
 in pyrimidine nucleotide synthesis regulation, 334
 retinoic acid role in, 529–530
 silencing of, 87
gene expression regulation
 alternative RNA processing and, 430
 amplification, 429, 429f

biomedical importance of, [409–410](#)
DNA-binding domains of regulatory transcription factor proteins, [425t](#)
 helix-turn-helix motif, [425–426](#), [426f](#)
 leucine zipper motif, [427](#), [427f](#)
 zinc finger motif, [426](#), [426f](#)
domain separation in, [427–428](#), [428f](#)
eukaryotic
 bacteriophage lambda as paradigm for protein-DNA interactions, [414–418](#), [414f](#), [415f](#), [416f](#), [417f](#)
 chromatin template in, [418–419](#)
 DNA enhancer elements and, [420–423](#), [422f](#), [422t](#), [423f](#)
 epigenetic mechanisms, [419–420](#), [420f](#), [421f](#)
 locus control regions and insulators in, [424–425](#)
 prokaryotes compared with, [428–430](#), [428t](#), [429f](#), [430f](#)
 reporter genes, [423](#), [424f](#)
 response diversity in, [424](#), [425f](#)
 special features of, [418](#)
 tissue-specific expression of, [423](#)
models of, [411](#)
mRNA stability and, [430](#), [430f](#)
ncRNA alteration of mRNA function in, [428–429](#)
operon model of, [411–412](#), [411f](#), [413f](#), [414](#)
positive and negative, [410](#), [410t](#)
prokaryotic
 eukaryotes compared with, [428–430](#), [428t](#), [429f](#), [430f](#)
 on-off manner of, [424](#)
 uniqueness of, [411](#)
RNA alternative processing for, [430](#)
targeted, [446–447](#)
temporal responses to, [410–411](#), [410f](#)
gene therapy, [4](#), [446](#)
 artificial membranes and, [465](#)
 biomedical importance of, [432](#)
 for lipid storage disorders, [235](#)
 mammalian viral vectors for, [437–438](#)
 for metabolic disorders, [278](#)
general acid–base catalysis, [59](#)

general transcription factors (GTFs), 381, 381f
 activators and coregulators and, 384–385
 in PIC formation, 385–386
 in RNA polymerase II formation, 383–384

genes
 alteration of, 359–361, 359f, 360f
 biomedical importance of, 338
 cancer, 682, 685–688, 685t, 686f, 687f, 687t, 688f, 688t
 chromosome localization of, 441, 442t
 of cytochromes P450, 557
 disease causing variations in, 442, 443f, 444t
 housekeeping, 411
 immunoglobulin, DNA rearrangement and, 360–361
 inducible, 411
 knockout/knockin, 446
 mapping of, 355, 441, 442t
 processed, 360
 targeted disruption of, 446–447

genetic code, 338. *See also* DNA
 l- α -amino acids specified by, 15, 15t–16t, 17t
 biomedical importance of, 393
 features of, 394–395, 395t
 triplet codes in, 394, 394t

genetic diseases
 of bone, 607, 607t
 gene therapy for, 446
 of membrane protein mutations, 478, 478t
 of muscles, 621–623, 622t, 623f, 624f
 recombinant DNA technology in diagnosis of, 442–445, 443f, 444f, 444t

genetic disorders
 amino acid metabolism defects, 276–278, 277t, 280–281, 293, 294t
 cancer, 683, 688, 690–691, 691t
 clotting system deficiencies, 678
 collagen defects in, 43–44
 enzymes for diagnosis of, 64–65
 fructose metabolism deficiencies, 190
 galactosemias, 191

glycogen storage diseases, 164, 166, 167*t*, 170
glycoprotein lysosomal hydrolase deficiencies, 554–555
hemoglobin mutations, 53–54, 54*f*
hemolytic anemia, 157, 163, 182, 188–189
porphyrias, 305, 308, 310–311, 310*t*, 311*f*
pyruvate dehydrogenase deficiency, 163
respiratory chain, 126
urea cycle defects, 276–278, 277*t*

genetic engineering, 432. *See also* recombinant DNA technology
genetic information, flow of, 393–394
genetic mutations. *See* mutations, genetic
Genevan system, for fatty acid nomenclature, 196

genome
function of, 356–357
microsatellite repeat sequences in, 358
nonrepetitive sequences in, 357
repetitive sequences in, 357–358
targeted gene regulation in, 446–447

genomic instability, in cancer, 691–692, 692*f*
genomic library, 438
genomic technology. *See* recombinant DNA technology
genomics, protein identification using, 28
geometric isomerism, of unsaturated fatty acids, 198, 198*f*
geranyl diphosphate, in cholesterol synthesis, 250, 251*f*
GGT. *See* γ -glutamyltransferase
GH. *See* growth hormone

Gibbs free-energy change (ΔG), 69–70, 70*f*
of ATP hydrolysis, 107–108, 107*t*, 108*f*
in biologic systems, 105–106
enzyme effects on, 72
equilibrium constant and, 69, 106
metabolic regulation and, 83–84, 83*f*
redox potential and, 111–112, 112*t*

Gilbert syndrome, 314
GK (glucokinase) gene, 388–389, 389*f*
GlcN (glucosamine), 602
glibenclamide, 215

α -globin gene
defective production of, 442–443, 443f
location of, 442t

β -globin gene, 421–422, 422f
defective production of, 442, 443f
location of, 442t
schematic representation of, cluster, 442, 443f
structural alterations of, 442, 444t

globular proteins, 34

globulins, 628

glomerular filtration, 598

glomerular membrane, 598

glomerulonephritis, 598–599

glucagon, 130, 138
blood glucose regulation by, 179, 179t
in cholesterol synthesis, 252–253, 253f
glycogen regulation by, 167
in glycolysis and gluconeogenesis regulation, 175
in lipogenesis regulation, 221–222, 222f

glucagon/insulin ratio, in ketogenesis regulation, 214

glucan, 145

glucan transferase, in glycogenolysis, 166, 166f

β -glucocerebrosidase, diagnostic use of, 64t

glucocorticoids
blood glucose regulation by, 179
in cholesterol synthesis, 252–253, 253f
in lipolysis, 246, 246f
NF- κ B pathway regulation by, 510–511, 510f
plasma transport of, 498–499, 499t
regulation of gene expression by, 501, 501f
synthesis of, 486–487, 486f
therapeutic use of, 511

glucogenic amino acids, 136, 272, 272f

glucogenic intermediates, 153

glucokinase, 158, 164, 165f, 726
blood glucose regulation by, 178–179, 179f
gene mutation of, 726t

glucokinase (*GK*) gene, 388–389, 389*f*
gluconeogenesis, 130, 133, 161
 biomedical importance of, 172
 blood glucose derived from, 177–178, 178*f*
 citric acid cycle role in, 153–154, 154*f*
 clinical aspects of, 180–181, 180*f*
 Gibbs free-energy change of, 84
 induction and repression of enzymes catalyzing, 174–175, 175*t*
 low carbohydrate diets and, 181
 propionate metabolism and, 174, 174*f*
 regulation of, 174–177, 175*t*, 176*f*, 177*f*
 reversal of glycolysis steps in, 172–174, 173*f*
gluconolactone hydrolase, in pentose phosphate pathway, 183*f*, 184, 184*f*
glucosamine, 145, 145*f*, 188, 190*f*
glucosamine (GlcN), 602
glucosan, 145
glucose
 absorption of, 520, 520*f*
 amino sugar synthesis from, 188, 190*f*
 biomedical importance of, 141, 144*t*
 blood levels of. *See* blood glucose
 breakdown of. *See* glycolysis
 in cancer cells, 695–696, 697*f*, 698*t*
 CNS and erythrocyte requirement for, 136
 in extracellular and intracellular fluid, 460*t*
 fatty acid synthesis from, 153–155, 155*f*
 galactose conversion to, 187–188, 189*f*
 in glycoproteins, 548*t*
 insulin regulation of, 136–138, 158
 isomerism of, 142–143, 143*f*, 144*f*
 as metabolic fuel, 130, 136
 metabolic pathways of, 130, 130*f*, 131*f*
 in fasting state, 138–139, 138*t*, 139*t*
 in fed state, 136–138, 137*f*, 138*t*
 at tissue and organ levels, 132–133, 132*f*, 133*f*
 as most important monosaccharide, 142
 in pentose phosphate pathway. *See* pentose phosphate pathway

permeability coefficient of, 463*f*
 structure of, 142, 142*f*
 synthesis of. *See* gluconeogenesis
 transport of, 473–474, 473*f*

glucose- 6-phosphate, in uronic acid pathway, 186–187, 187*f*

glucose oxidase, plasma glucose concentration measurement using, 64

glucose tolerance, 180–181, 180*f*

glucose transporters (GLUT), 178, 178*t*

- in blood glucose regulation, 245, 245*f*
- in erythrocytes, 648, 648*t*
- insulin and, 470, 473, 473*f*

glucose uniporter (GLUT2), 473–474, 473*f*

glucose-1-phosphate

- gluconeogenesis and, 173*f*, 174
- glycogen release of, 164, 166, 166*f*
- in glycogenesis, 164, 165*f*

glucose-6-phosphatase

- deficiency of, 335
- in gluconeogenesis, 173*f*, 174
- in glycogenolysis, 166

glucose-6-phosphate

- in gluconeogenesis, 173*f*, 174
- in glycogenesis, 164, 165*f*
- in glycolysis, 158, 159*f*
- in pentose phosphate pathway, 182–185, 183*f*, 184*f*

glucose-6-phosphate dehydrogenase (G6PD)

- case study, 721–722
- deficiency of, 182, 188–189, 650–651, 650*t*, 651*f*
- in pentose phosphate pathway, 183–184, 183*f*, 184*f*

glucose-alanine cycle, 177, 178*f*

glucoside, 145

glucosuria, 180

glucosylceramide, 202, 234, 234*f*, 461

glucuronate, 143, 145*f*

- bilirubin conjugation with, 312, 312*f*
- uronic acid pathway production of, 186–187, 187*f*

glucuronic acid, uronic acid pathway formation of, 182

β -glucuronidases, 313
glucuronidation, of xenobiotics, 558
glucuronide conjugates, glucuronate production for, 186–187, 187f
glucuronides, 182
GLUT. *See* glucose transporters
GLUT2 (glucose uniporter), 473–474, 473f
GLUT4 transporter, 245
glutamate
 carbon skeleton catabolism of, 282
 carboxylation of, 532–533, 533f
 in citric acid cycle, 153, 154f
 synthesis of, 264–265, 265f
 transamination reactions forming, 272–273, 273f
glutamate aminotransferase, transamination reaction of, 273, 273f
glutamate dehydrogenase (GDH)
 in amino acid synthesis, 265, 265f
 in nitrogen metabolism, 273, 274f
glutamate- γ -semialdehyde dehydrogenase, 285f, 286
glutamic acid, 16t
glutaminase, 274, 274f
 in amino acid catabolism, 282
glutamine, 16t
 ammonia fixation as, 274, 274f
 carbon skeleton catabolism of, 282
 circulating plasma levels of, 271–272, 271f, 272f
 in citric acid cycle, 153, 154f
 deamination of, 274, 274f
 synthesis of, 265, 265f
glutamine analogs, purine nucleotide synthesis affected by, 328, 330
glutamine synthetase, 265, 265f
 ammonia fixation by, 274, 274f
 γ -glutamyltransferase (GGT), 558
 diagnostic use of, 64t
 γ -glutamyl- β -aminopropionitrile (BAPN), 18, 18t
glutaric acid, pK_a of, 13t
glutathione, 21, 21f, 558, 713, 721, 721t
glutathione peroxidase, 204, 544

hemolysis protection from, 185–186, 186*f*, 189
selenium in, 114, 185–186, 186*f*
glutathione reductase, 185, 186*f*, 189, 721, 721*t*
glutathione S-transferase (GST)
 fusion protein purification with, 65–66, 66*f*
 in xenobiotic metabolism, 558
glyburide, 215
N-glycan chains, 581
glycans, 546, 547*t*, 550–551, 550*f*
 in virus, bacteria, and parasite binding, 555
glycated hemoglobin (HbA_{1c}), 55, 553
glycation, 546
 in diabetes mellitus, 55, 553, 553*f*
glycemic index, 145, 520
glyceraldehyde-3-phosphate
 in glycolysis, 159, 159*f*, 160*f*
 in pentose phosphate pathway, 182–185, 183*f*, 184*f*
glyceraldehyde-3-phosphate dehydrogenase, in glycolysis, 159, 159*f*, 160*f*
glycerol, 196, 199
 absorption of, 521
 in gluconeogenesis, 174
 permeability coefficient of, 463*f*
glycerol ether phospholipids, synthesis of, 230, 232, 232*f*
glycerol kinase, 229, 230, 231*f*, 244
glycerol moiety, 130
glycerol phosphate acyltransferase, mitochondrial compartmentalization
 of, 118
glycerol phosphate pathway, 231*f*
glycerol-3-phosphate
 acylglycerol biosynthesis and, 230, 231*f*
 triacylglycerol esterification and, 244–245, 245*f*
glycerol-3-phosphate acyltransferase, 230, 231*f*
glycerol-3-phosphate dehydrogenase, 230, 231*f*
glycerophosphate shuttle, 125, 125*f*
glycerophospholipids, 196, 199, 201*f*
glycerose, 142, 143*f*
glycine, 15*t*

- carbon skeleton catabolism of, [282–283](#), [284f](#)
- heme biosynthesis from, [305–307](#), [306f](#), [307f](#), [308f](#), [309f](#), [310t](#)
- specialized products of, [298](#), [298f](#), [300–301](#), [302f](#)
- synthesis of, [265](#), [266f](#)
- threonine conversion to, [285](#), [285f](#)
- glycine cleavage complex, [282–283](#), [284f](#)
- glycine residues, [593](#)
- glycinuria, [283](#)
- glycobiology, [141](#)
- glycocalyx, [147](#), [202](#), [229](#)
- glycochenodeoxycholic acid, [256f](#)
- glycocholic acid, [256f](#)
- glycoconjugate carbohydrates, glycoproteins as, [546](#)
- glycogen, [141](#)
 - biomedical importance of, [164](#)
 - breakdown of, [157](#), [158f](#), [158t](#)
 - clinical aspects of, [170](#)
 - gluconeogenesis and, [173f](#), [174](#)
 - glycogenesis reaction pathway for, [132](#), [164–166](#), [165f](#), [166f](#)
 - glycogenolysis reaction pathway for, [165f](#), [166](#), [166f](#), [167t](#)
 - liver synthesis of, [136–137](#)
 - as metabolic fuel, [130](#), [136](#)
 - metabolic pathways of, [130](#), [132–133](#), [132f](#)
 - in muscle contraction, [620](#), [621f](#)
 - regulation of, [166–170](#), [168f](#), [169f](#), [170f](#), [171f](#)
 - storage function of, [145–146](#), [147f](#), [164](#), [165t](#)
- glycogen phosphorylase, [620](#)
 - in glycogenolysis, [166](#), [166f](#)
 - regulation of, [89t](#), [166–168](#), [169f](#), [170](#), [171f](#)
- glycogen primer, [164–165](#)
- glycogen storage diseases, [164](#), [166](#), [167t](#), [170](#)
- glycogen synthase
 - gluconeogenesis and, [173f](#), [174](#)
 - in glycogenesis, [165](#), [165f](#), [166f](#)
 - regulation of, [89t](#), [166–168](#), [170](#), [170f](#), [171f](#)
- glycogen synthase a, [168](#)
- glycogen synthase b, [168](#)

glycogenesis, [132](#)
 reaction pathway of, [164–166](#), [165f](#), [166f](#)
 regulation of, [166–170](#), [168f](#), [169f](#), [170f](#), [171f](#)
glycogenin, in glycogenesis, [164–165](#), [165f](#)
glycogenolysis, [133](#)
 blood glucose derived from, [177–178](#), [178f](#)
 induction and repression of enzymes catalyzing, [174–175](#), [175t](#)
 reaction pathway of, [165f](#), [166](#), [166f](#), [167t](#)
 regulation of, [166–170](#), [168f](#), [169f](#), [170f](#), [171f](#)
glycolipid storage diseases, [229](#)
glycolipids, [196](#), [202](#), [202f](#)
 galactose production for, [187–188](#), [189f](#)
glycolysis, [130](#), [131f](#)
 in anaerobic conditions, [157](#), [158f](#), [158t](#)
 biomedical importance of, [157](#)
 in cancer cells, [695–696](#), [697f](#), [698t](#)
 clinical aspects of, [163](#)
 dihydroxyacetone phosphate in, [230](#), [231f](#), [232f](#)
 in energy conservation and capture, [108](#)
 in erythrocytes, [161](#), [161f](#), [648](#), [648t](#)
 flux-generating reaction in, [135](#)
 Gibbs free-energy change of, [84](#)
 gluconeogenesis regulation and, [174–177](#), [175t](#), [176f](#), [177f](#)
 induction and repression of enzymes catalyzing, [174–175](#), [175t](#)
 pentose phosphate pathway connections with, [183f](#), [185](#)
 pyruvate oxidation after, [161–163](#), [162f](#)
 reactions of, [157–160](#), [159f](#), [160f](#)
 regulation of, [160–161](#)
 at subcellular level, [134](#), [134f](#)
 thermodynamic barriers to reversal of, [172–174](#), [173f](#)
glycome, [141](#)
glycomics, [3](#), [141](#), [447](#)
glycophorins, [147](#), [549](#), [652](#), [652t](#)
glycophosphatidylinositol, [463](#)
glycoprotein complex GPIIb-IIIa, in platelet aggregation, [670](#), [671f](#)
glycoprotein glycosyltransferases, [549–550](#)
glycoproteins, [34](#), [147](#), [148t](#), [628](#), [653](#)

- amino sugars in, 145, 145*f*, 188
- biologic information encoded in, 546
- biomedical importance of, 546
- classes of, 547, 548*f*, 549
- degradation of, 270
- in diabetes mellitus, 553, 553*f*
- disorders involving, 554–555
- extracellular, absorptive pinocytosis of, 475
- functions of, 546, 547*t*, 553–554
- galactose production for, 187–188, 189*f*
- N*-glycosidic linkages in, 547, 548*f*, 550–551, 550*f*, 551*f*
- O*-glycosidic linkages in, 547, 548*f*, 549–550
- as hormone precursors, 484, 484*f*
- membrane asymmetry and, 464
- microfibril-associated, 597
- monosaccharides commonly found in, 547, 548*t*
- oligosaccharide chains in, 546, 547*t*, 550–551, 550*f*, 555
- on plasma membrane, 552
- protein folding role of, 551–552
- purification of, 547
- rapidly reversible, 552–553
- regulation of, 552
- synthesis of, 549–551, 551*f*
- in virus, bacteria, and parasite binding, 555
- glycosaminoglycans (GAGs), 147, 148*f*
 - amino sugars in, 145, 145*f*, 188
 - components of, 599, 599*f*, 600*f*
 - functions of, 603*t*
 - mucopolysaccharidoses and, 603–604, 604*t*
 - properties of, 602*t*
 - structures of, 601–603, 601*f*
 - synthesis of, 599–600
- 1,6-glycosidase, in glycogenolysis, 166, 166*f*
- glycosides, 145
- N*-glycosides
 - nucleosides as, 320, 321*f*
 - syn* and *anti* conformers of, 320–321, 321*f*, 322*t*

N-glycosidic linkages, in glycoproteins, 547, 548*f*, 550–551, 550*f*, 551*f*
O-glycosidic linkages, 593, 599–600
 in glycoproteins, 547, 548*f*, 549–550
glycosphingolipids (GSLs), 196, 202, 202*f*, 229, 478, 654
 amino sugars in, 188
 membrane asymmetry and, 464, 590
 in membranes, 461
 synthesis of, 234, 234*f*
N-glycosylamine bond, 600
glycosylation, 546. *See also* glycoproteins
 congenital disorders of, 633
 cotranslational, 581
 in diabetes mellitus, 553
 of hydroxylysines, 594
 mass spectrometry detection of, 28*t*
 rapidly reversible, 552–553
 regulation of, 552
glycosylphosphatidylinositol (GPI), 588
glycosylphosphatidylinositol-anchored (GPI-anchored) glycoproteins,
 548*f*, 549, 552
glycosyltransferases, 546, 600
GM1 ganglioside, 202, 202*f*
GM₃ ganglioside, 202
GMP, 322*t*
 cyclic. *See* cyclic GMP
 IMP conversion to, 328, 330*f*, 331, 331*f*
 PRPP glutamyl amidotransferase regulated by, 330, 331*f*
Golgi apparatus (GA)
 brefeldin A and, 588
 exocytosis in, 475
 in membrane synthesis, 574
 in protein sorting, 574, 575*f*, 584
 protein sorting signals in, 573, 574*t*
 in protein synthesis, 405, 574
 proteins destined for membrane of, 574, 581
 retrograde transport from, 582–584
 in VLDL formation, 239*f*

gonadal steroids, transport of, [498t](#), [499](#)
gout, [190](#), [244](#), [334](#), [336t](#)
gouty arthritis, [334](#), [336t](#)
gp 120, [555](#)
GPCRs (G-protein-coupled receptors), [503](#), [503f](#), [657–658](#)
GPI (glycosylphosphatidylinositol), [588](#)
GPI-anchored (glycosylphosphatidylinositol-anchored) glycoproteins, [548f](#), [549](#), [552](#)
GPIb-IX-V, in platelet aggregation, [670](#), [671f](#)
G-protein-coupled receptors (GPCRs), [503](#), [503f](#), [657–658](#)
G-proteins (guanine-binding protein), [503](#), [658](#)
 classes and functions of, [504t](#)
 family of, [504](#)
gramicidin, [14](#), [472](#)
granules, [659](#)
 α -granules, [654](#)
granulocytes, [656](#), [659](#)
gratuitous inducers, [412](#)
griseofulvin, [625](#)
GroEL, [575](#)
group transfer potential, [107](#), [110](#)
 of nucleoside triphosphates, [324](#)
group transfer reactions, [9](#), [59](#), [59f](#)
growth, energy requirements for, [129](#)
growth differentiation factor 15 (GDF15), [635](#)
growth factors, in cancer, [689](#), [689t](#)
growth hormone (GH)
 amino acid transport and, [470](#)
 blood glucose regulation by, [179](#)
 gene location of, [442t](#)
 receptors for, [482](#)
growth inhibitory factors, in cancer, [689](#)
GSLs. *See* glycosphingolipids
GST. *See* glutathione S-transferase
GTFs. *See* general transcription factors
GTP, [323](#), [587](#), [588](#)
GTPase-accelerating proteins (GAPs), [578](#)

GTPases, 578–579, 587
GTP-binding proteins, 251
guanine, 322*t*
 base pairing in DNA, 339, 340*f*
 base pairing in RNA, 342, 343*f*
 ROS oxidation of, 711*f*
 salvage pathways of, 332–333
guanine nucleotide exchange factors (GEFs), 578, 578*f*
guanine-binding protein. *See* G-proteins
guanosine, 321*f*, 322*t*
 salvage pathways of, 332–333
 in uric acid formation, 334, 335*f*
guanosine diphosphate. *See* GDP
guanosine monophosphate. *See* GMP
guanosine triphosphate. *See* GTP
Guillain-Barré syndrome, 473
l-gulonolactone oxidase, 186
Guthrie bacterial inhibition test, 566

H

H bands, 612, 612*f*, 613*f*
H blood group substances, 653–654, 654*f*
H1 histones, 351, 351*f*, 352*f*, 353, 353*t*
H2A histones, 351, 351*f*, 353
H2AX histone, 371
H2B histones, 351, 351*f*, 353
H3 histones, 351, 351*f*, 353, 353*t*
H4 histones, 351, 351*f*, 353, 353*t*
hairpin, 342, 343*f*
half-life ($t_{1/2}$)
 of plasma proteins, 630
 of proteins, 270
halt-transfer signal, 582, 583*f*
haptocorrin, 101
haptoglobin, 631–632, 631*f*
haptoglobin-related protein, 632
Hartnup disease, 288, 289*f*, 535

HAT (histone acetyltransferase activity), 513–514
Haworth projection, 142, 142f
Hb Hikari, 397f
HbA_{1c} (glycated hemoglobin), 55, 553
HbF (fetal hemoglobin), 50–51, 51f, 53
HbM (hemoglobin M), 53–54, 397f
HbS (hemoglobin S), 54, 54f, 397f
HBV (hepatitis B virus), 703
HDACs (histone deacetylases), 89, 690
HDL. *See* high-density lipoproteins
HDL cycle, 241f, 242
HDL receptor, 238, 241f, 242
health, 2–4, 2f, 3f
heart
 in fasting state, 130, 138–139, 138t, 139f, 139t
 in fed state, 130, 136–138, 137f, 138t
heart failure, 611
 cardiolipin in, 201
 vitamin B₁ deficiency in, 534
heartbeat hypothesis, 715–716
heat, respiratory chain production of, 123
heat-shock proteins (hsp), as chaperones, 41, 576
heavy metals, toxicity of, 93–94
Heinz bodies, 651
helicases, 362f, 363, 363t
Helicobacter pylori, glycans in binding of, 555
helix-loop-helix motifs, 36
helix-turn-helix motif, 425–426, 426f
helper T cells, 659, 662
hemagglutinin, influenza, 555
hematoma, 311
hematopoietic stem cells, blood cells derivation from, 646–647, 647f
hematoporphyrin, 308
heme
 binding of, 631
 biomedical importance of, 305

biosynthesis of, 305–307, 306*f*, 307*f*, 308*f*, 309*f*, 310*t*
 disorders of, 309–311, 310*t*, 311*f*
 regulation of, 307–308
catabolism of, 311–313, 312*f*, 313*f*
in catalase, 114
in Complex IV, 120, 120*f*
in hemoglobin, 48–49, 48*f*, 49*f*, 53–54
histidines in, 48, 48*f*, 54
iron in, 48–49, 48*f*, 49*f*, 53–54, 95–97
in oxidases, 112
oxidation of, 649–651, 650*f*, 650*t*, 651*f*
structure of, 48, 48*f*, 305, 306*f*
heme oxygenase, 311, 312*f*, 631
hemerythrin, diiron center of, 97, 97*f*
hemiacetals, 142, 142*f*
hemiconnexin, 476*f*
hemin, 311
hemochromatosis, 523
 hereditary, 636, 638*t*, 650
hemocyanin, copper in, 100
hemoglobin, 629*f*
 allosteric properties of, 50–53, 50*f*, 51*f*, 52*f*, 53*f*
 biomedical implications of, 54–55
 biomedical importance of, 47–48
 2,3-bisphosphoglycerate binding of, 50*f*, 53, 53*f*
 carbon dioxide transport by, 52, 53*f*
 conformational changes upon oxygenation of, 51–52, 51*f*, 52*f*
 cooperative binding of, 51
 extracorporeal, haptoglobin binding of, 631, 631*f*
 glycated, 55, 553
 heme in, 48–49, 48*f*, 49*f*, 53–54
 high altitude levels of, 53
 hindered environment of, 49, 49*f*
 mutations in, 397*f*
 mutations of, 53–54, 54*f*
 oxygen dissociation curve of, 49–50, 49*f*
 P₅₀ values of, 51, 51*f*

- pathologic conformations of, 42
- proton binding of, 52–53, 53*f*
- quaternary structure of, 50–53, 50*f*, 51*f*, 52*f*, 53*f*
- relaxed and taut states of, 49–50
- salt bridges in, 52–53
- secondary and tertiary structures of, 50
- subunits of, 50, 50*f*
- tetrameric structure of, 50, 50*f*
- turnover of, 311
- hemoglobin (Hb) Hikari, 397*f*
- hemoglobin M (HbM), 53–54, 397*f*
- hemoglobin S (HbS), 54, 54*f*, 397*f*
- hemoglobinopathies, 53–54, 54*f*, 651
- hemoglobinopathy, 359, 360*f*
- α -hemoglobin–stabilizing protein (AHSP), 42
- hemoglobinuria, paroxysmal nocturnal, 478*t*, 650*t*, 651
- hemojuvelin (HJV), 635
- α -hemolysin, 472
- hemolysins, 651
- hemolysis
 - pentose phosphate pathway and glutathione peroxidase protection against, 185–186, 186*f*
 - pentose phosphate pathway impairment leading to, 188–189
- hemolytic anemias, 157, 163, 182
 - causes of, 651, 651*f*
 - hyperbilirubinemia with, 313, 315, 315*t*
 - pentose phosphate pathway impairment in, 188–189
- hemolytic-uremic syndrome, 655
- hemopexin, 631, 631*f*
- hemophilia, 627
- hemophilia A, 678
- hemophilia B, 678
- hemoproteins
 - biomedical importance of, 305
 - examples of, 305, 306*t*
- hemosiderin, 633
- hemosiderosis, 633, 636

hemostasis, [654–655](#)
 biomedical importance of, [669](#)
 coagulation. *See* coagulation system
 fibrinolysis. *See* fibrinolysis
 laboratory tests measuring, [679](#)
 phases of, [669](#)
 thrombin regulation in, [677](#)

hemostatic plugs, formation of, [670](#), [671f](#)

Henderson-Hasselbalch equation, [12](#), [12f](#)

heparan sulfate, [595](#), [599](#), [601f](#), [602–603](#), [602t](#)
 in hemostasis and thrombosis, [672](#)

heparin, [147](#), [148f](#), [597](#), [599](#), [602t](#), [677–678](#)
 lipoprotein and hepatic lipases and, [240](#)
 structure of, [601f](#), [602](#), [602f](#)

heparin cofactor II, [677](#)

hepatic lipase
 in chylomicron remnant uptake, [240–241](#), [241f](#)
 deficiency of, [258t](#)
 metabolism by, [240](#)

hepatic porphyrias, [310t](#), [311](#)

hepatic portal vein, [177](#)

hepatic purine biosynthesis
 AMP and GMP formation regulation in, [331](#), [331f](#)
 PRPP glutamyl amidotransferase regulation in, [330](#)

hepatitis, [150](#)
 hyperbilirubinemia caused by, [315](#), [315t](#)

hepatitis B virus (HBV), [703](#)

hepatocarcinoma, [243](#)

hepatocytes
 heme synthesis in, [306](#)
 pinocytosis by, [475](#)

hepatolenticular degeneration (Wilson disease), [298](#), [478t](#), [627](#), [634](#)

hepcidin, [523–524](#), [523f](#), [635](#), [636f](#), [637f](#)

hepcidin system, [94](#)

hephaestin, [632–633](#)

heptoses, [141](#), [142t](#)

hereditary bleeding disorders, [678](#)

hereditary cancers, 683, 688, 690–691, 691t
hereditary elliptocytosis, 651, 653
hereditary fructose intolerance, 190
hereditary hemochromatosis, 636, 638t, 650
hereditary mutations, 683
hereditary nonpolyposis colon cancer, 370t
hereditary spherocytosis, 478t, 650t, 651, 653
Hermansky-Pudlak syndrome, 585t
herpes simplex virus, 380f
heterochromatin, 354
heterodimers, 38
heterogeneous regulatory RNAs (sRNAs), 348
heterotrophic organisms, 107
hexapeptide, in albumin synthesis, 630
hexokinase, 57, 726
 blood glucose concentration and, 178–179, 179f
 coupled enzyme assay for, 63f
 as flux-generating step in glycolysis, 135
 in fructose metabolism, 186, 188f
 in glycogenesis, 164
 in glycolysis, 158, 159f
 regulation of, 161
 reversal of reaction catalyzed by, 173f, 174
hexosamines, 145, 145f
 synthesis of, 188, 190f
hexose monophosphate shunt. *See* pentose phosphate pathway
hexose-6-phosphate dehydrogenase, 184–185
hexoses, 141, 142t
 of physiological importance, 143, 144t
HFS (high-fructose syrups), 186, 188f, 189–190
HGP (Human Genome Project), 3–4, 3f
HhaI, 433t
HHH (hyperornithinemia, hyperammonemia, and homocitrullinuria)
 syndrome, 277
HIF-1 (hypoxia-inducible factor-1), 696–697
high altitude, physiologic adaptations to, 53
high-density lipoproteins (HDL), 237, 237t

- apolipoproteins of, 238
- atherosclerosis and, 242, 257
- cholesterol removal by, 249
- familial deficiency of, 258t
- LDL ratio to, 257
- metabolism of, 241–242, 241f
- receptor for, 238, 241f, 242
- synthesis of, 241, 241f

high-density microarray technology, 447

high-energy phosphates

- creatine phosphate shuttle for, 126, 126f
- cycles of, 109, 109f
- energy capture and transfer by, 107–108, 107t, 108f, 121–122
- oxidative phosphorylation in synthesis of, 118, 121–122, 122f

high-fructose syrups (HFS), 186, 188f, 189–190

high-mannose oligosaccharides, in glycoproteins, 550–551, 550f

high-pressure liquid chromatography (HPLC)

- laboratory tests using, 564
- protein and peptide purification with, 24, 25f

high-throughput sequencing (HTS), 62–63, 445–446

Hill coefficient (n), 76, 76f

Hill equation, 76, 76f

HindIII, 433t

hippuric acid, glycine conversion to, 298, 298f

histamine, 298, 298f, 657f, 662

histidase, 282

histidine, 16t, 657f

- carbon skeleton catabolism of, 282, 283f
- fusion protein purification with, 65
- in heme, 48, 48f, 54
- resonance hybrids of, 18–19, 19f
- specialized products of, 298, 298f

histidinemia, 282

histone acetyltransferase activity (HAT), 513–514

histone chaperones, 353

histone code, 87, 418–419

histone covalent modification, 418–419

histone deacetylases (HDACs), 89, 690
histone dimer, 351, 351f, 353
histone epigenetic code, 419
histone octamer, 351, 351f, 352f, 353
histone tetramer, 351, 351f, 353
histones, 351, 351f, 353, 353t
 covalent modifications of, 87
 modifications of, 384
HIV. *See* human immunodeficiency virus
HIV protease, acid–base catalysis of, 60, 60f
HJV (hemojuvelin), 635
HMG-CoA. *See* 3-hydroxy-3-methylglutaryl-CoA
homeostasis, 82
 in ER, 584
 hormone signal transduction and, 500–501, 501f
 intracellular iron, 634–635, 635f, 636f, 637f
homeostatic adaptations, 500
l-homoarginine, 18, 18t
homocarnosine, biosynthesis of, 298, 298f, 303
homocarnosinosis, 303
homocysteine, 283, 284f
homocystinuria, 283–285, 300
homodimers, 38
homogentisate dioxygenase, 115
homogentisate oxidase, 286, 287f
homologous recombination (HR), 369, 370f, 370t
homologs, protein, 61
homology, protein classification based on, 34
homology modeling, protein structures solved by, 41
homopolymer tailing, 434t
hormone receptor–G-protein effector system, 503f
hormone receptors
 classification of, 482, 483t
 as proteins, 482
 recognition and coupling domains of, 481–482
 specificity and selectivity of, 481, 481f
hormone response elements (HRE)

- DNA sequences of, [502t](#)
- gene expression and, [423](#), [424f](#)
- in signal generation, [501](#), [502f](#)
- types of, [511](#)

hormone response transcription unit, [512f](#)

hormone synthesis

- active form and, [484](#)
- adrenal steroidogenesis, [485–487](#), [485f](#)
- androgen synthesis, [486f](#), [487](#)
- angiotensin II, [495–496](#), [496f](#)
- calcitriol, [489–491](#)
- catecholamines, [491–492](#), [491f](#)
- cellular arrangements of, [483](#)
- from cholesterol, [202](#), [249](#), [483](#), [484f](#), [485–491](#), [485f](#)
- dihydrotestosterone, [483](#), [487](#), [489f](#)
- glucocorticoids, [486–487](#), [486f](#)
- insulin, [493–494](#), [494f](#)
- iodide metabolism and, [492](#)
- mineralocorticoids, [485–486](#), [486f](#)
- ovarian steroidogenesis, [487–489](#), [489f](#), [490f](#)
- parathyroid, [494](#), [495f](#)
- peptide precursors for, [492–493](#)
- POMC family, [496–497](#), [497f](#)
- testicular steroidogenesis, [487](#), [488f](#)
- tetraiodothyronine, [492](#), [493f](#)
- triiodothyronine, [492](#), [493f](#)

hormone-dependent cancer, vitamin B₆ and, [535](#)

hormones

- active form of, [484](#)
- adenylyl cyclase and, [503t](#)
- of adipose tissue, [244](#)
- amino acid precursors of, [18](#)
- biomedical importance of, [500](#)
- in blood glucose regulation, [178–180](#), [178t](#), [179t](#)
- cell surface receptor binding of, [482](#), [483t](#)
- chemical diversity of, [483–484](#), [484f](#)
- definition, [480](#)

enzyme regulation by, 86, 135–136, 135f
facilitated diffusion regulation by, 469–470
features of, 483t
hepatic VLDL secretion and, 242–243, 243f
intracellular receptor binding of, 482, 483t
laboratory tests for, 565
lipogenesis regulation by, 247
lipolysis regulation by, 245–247, 246f
lipophilic, 482, 483t
peptide, 546
plasma transport proteins of, 498–499, 498t
precursor molecule for, 483–484, 484f
receptor interaction of, 500–501, 501f
as second messengers. *See* second messengers
signal generation by. *See* signal generation
signal transduction by, 500–501, 501f
stimulus response of, 500–501, 501f
storage and secretion of, 497, 497t
transcription modulation by, 511–514, 512f, 513f, 513t, 514t
vitamin D as, 530–531, 531f
water-soluble, 482, 483t

housekeeping genes, 411
HpaI, 433t, 434f
HPLC. *See* high-pressure liquid chromatography
HPV (human papillomavirus), 703
HR (homologous recombination), 369, 370f, 370t
HRE. *See* hormone response elements
hsp (heat-shock proteins), as chaperones, 41, 576
Hsp60, 575
Hsp70, 576
HTS (high-throughput sequencing), 62–63, 445–446
human genes, localization of, 441, 442t
Human Genome Project (HGP), 3–4, 3f
human immunodeficiency virus (HIV)
 glycans in binding of, 555
 undernutrition caused by, 525
human papillomavirus (HPV), 703

human β -interferon gene enhancer, 422, 423f
humoral immunity, 662
Hunter syndromes, 603, 604t
Hurler syndromes, 603, 604t
Hutchinson-Gilford progeria syndrome, 625
hyaline cartilage, 607, 608t
hyaluronic acid, 147, 148f, 599, 601, 601f, 602t, 608, 608f, 609f
hyaluronidase, 603–604
hybrid oligosaccharides, in glycoproteins, 550–551, 550f
hybridization, 341
hybridomas, 643
hydrogen bonds
 in collagen, 43
 definition of, 7
 in DNA, 339–340, 340f
 hydrophobic interactions and, 8
 in protein tertiary and quaternary structures, 39
 water molecule formation of, 7, 7f
 in α helices, 35, 35f
 in β sheets, 36, 36f
hydrogen ions
 reaction rate response to, 72–73, 73f
 in water, 9–13, 12f, 13t
hydrogen peroxide, 710
 amino acid oxidase generation of, 273
 glutathione peroxidase removal of, 114, 185–186, 186f
 reduction of, 114
hydrogen sulfide, respiratory chain inhibition by, 112, 123
hydrogenation, dehydrogenation coupling to, 106, 107f
hydrolases, 57
 cholesteryl ester, 253
hydrolysis
 of ATP, 107–108, 107t, 108f
 of bound GTP to GDP, 587
 as group transfer reaction, 9
 of triacylglycerols, 229
 of water, 9

hydronium ions, 9–10
hydropathy plot, 463
hydroperoxidases, 112, 114
hydroperoxides, 225, 227*f*
hydrophilic portion of lipid molecule, 205, 205*f*
hydrophobic domains, 37
hydrophobic effect, in lipid bilayer self-assembly, 462
hydrophobic interaction chromatography, protein and peptide purification with, 25
hydrophobic interactions, 8, 339
 in protein tertiary and quaternary structures, 39
hydrophobic portion of lipid molecule, 205, 205*f*
hydrostatic pressure, 628
hydroxide ions, 9–10
3-hydroxy-3-methylglutaryl-CoA (HMG-CoA)
 in cholesterol synthesis, 250, 251*f*
 in ketogenesis, 211, 212*f*
 in mevalonate synthesis, 250, 251*f*
3-hydroxy-3-methylglutaryl-CoA (HMG-CoA) lyase
 deficiency of, 215
 in ketogenesis, 211, 212*f*
3-hydroxy-3-methylglutaryl-CoA reductase, regulation of, 90
3-hydroxy-3-methylglutaryl-CoA (HMG-CoA) reductase
 cholesterol synthesis controlled by, 250, 251*f*, 252–253, 253*f*
 drugs targeting, 84
 in mevalonate synthesis, 250, 250*f*
 regulation of, 86, 89*t*
3-hydroxy-3-methylglutaryl-CoA (HMG-CoA) reductase kinase,
 regulation of, 89*t*
3-hydroxy-3-methylglutaryl-CoA (HMG-CoA) synthase
 in cholesterol synthesis, 250, 251*f*
 in ketogenesis, 211, 212*f*
 in mevalonate synthesis, 250, 250*f*
L-3-hydroxyacyl-CoA dehydrogenase, 209, 209*f*
3-hydroxyanthranilate dioxygenase, 115
hydroxyapatite, 604–605
D-3-hydroxybutyrate, 207, 210, 211*f*

D-3-hydroxybutyrate dehydrogenase, 210, 211*f*
4-hydroxybutyric aciduria, 303
 β -hydroxybutyric aciduria, 327, 335–336, 337*f*
7 α -hydroxylase, sterol, 255, 256*f*
17 α -hydroxylase, 486, 488*f*
18-hydroxylase, 485–486
27-hydroxylase, sterol, 255, 256*f*
hydroxylase cycle, 115, 116*f*
hydroxylases, 115
 in cortisol synthesis, 486–487
 vitamin C as coenzyme for, 539
hydroxylation
 mass spectrometry detection of, 28*t*
 of proline, 594
 of xenobiotics, 556–558
hydroxylysine, synthesis of, 266, 268*f*
5-hydroxylysine, 17, 17*f*
hydroxylysines, 594
hydroxymethylbilane, in heme synthesis, 306, 307*f*, 308*f*, 309*f*
hydroxymethylbilane synthase, 306, 307*f*, 308*f*, 309*f*
 deficiency in, 310, 310*t*
5-hydroxymethylcytosine, 321, 323*f*
hydroxyproline, 593, 596
 carbon skeleton catabolism of, 285–286, 285*f*
 synthesis of, 266, 268*f*
4-hydroxyproline, 17, 17*f*
4-hydroxyproline dehydrogenase, 285–286, 285*f*
15-hydroxyprostaglandin dehydrogenase, 224–225
19-hydroxysteroid, 485
 β -hydroxy- γ -trimethylammonium butyrate. *See* carnitine
hyperalphalipoproteinemia, familial, 258*t*
hyperammonemia, 150, 156
 urea cycle disorders causing, 276–278, 277*t*
hyperbilirubinemia, 305, 313–314, 313*t*
 metabolic disorders underlying, 314–315, 314*f*, 315*t*
hyperbilirubinemic toxic encephalopathy, 313–314
hypercholesterolemia, 226, 237, 241, 257, 258*t*, 478, 478*t*, 585*t*

fructose role in, [186](#), [188f](#), [189–190](#)
hyperchromicity of denaturation, [340](#)
hyperglycemia, [140](#), [172](#)
hyperglycinemia, nonketotic, [283](#)
hyperhomocysteinemia, folic acid supplements for, [538](#)
hyperhydroxyprolinemia, [285f](#), [286](#)
hyperkalemic periodic paralysis, [620t](#)
hyperketonemia, [215](#)
hyperlacticacidemia, [244](#)
hyperlipidemia, [257](#)
hyperlipoproteinemias, [236](#), [257](#), [258t](#)
hyperlysinemia, [286](#)
hypermetabolism, disease causing, [157](#), [525](#)
hypermethioninemia, [298–299](#)
hyperornithinemia, hyperammonemia, and homocitrullinuria (HHH) syndrome, [277](#)
hyperornithinemia–hyperammonemia syndrome, [282](#)
hyperoxaluria, [283](#)
hyperphenylalaninemias, [286](#), [288f](#)
hyperprolinemia, [282](#), [282f](#), [285f](#), [286](#)
hypersensitive sites, chromatin, [354](#)
hypersplenism, [651](#)
hypertension, folic acid supplements for, [538](#)
hyperthermia, malignant, [618–619](#), [620t](#)
hypertriacylglycerolemia, [236](#), [258t](#)
fructose role in, [186](#), [188f](#), [189–190](#)
hypertrophic cardiomyopathy, familial, [622](#)
hyperuricemia, [334](#)
fructose role in, [189–190](#)
hypoceruloplasemia, [633](#)
hypoglycemia, [172](#), [181](#)
fatty acid oxidation and, [207](#), [214–215](#)
fructose-induced, [190](#)
during pregnancy and in neonates, [180](#)
hypoglycin, [207](#), [215](#)
hypokalemic periodic paralysis, [620t](#)
hypolipidemic drugs, [257](#)

hypolipoproteinemia, [236](#), [257](#), [258t](#)
hypothyroidism, cardiolipin in, [201](#)
hypouricemia, [335](#)
hypoxanthine, [321](#), [323f](#)
 salvage pathways of, [332–333](#)
hypoxanthine-guanine phosphoribosyl transferase, [334–335](#), [336t](#)
 gene location of, [442t](#)
hypoxia, in cancer cells, [696–697](#)
hypoxia-inducible factor-1 (HIF-1), [696–697](#)
hypoxic conditions, glycolysis in, [157](#), [158f](#), [158t](#), [160](#)

I

I bands, [612](#), [612f](#), [613f](#)

IAPs (inhibitors of apoptosis), [693f](#), [694](#)

ibuprofen, [216](#), [226](#)

IC₅₀, [78](#)

I-cell disease, [478](#), [478t](#), [554](#), [585t](#)

ICF (intracellular fluid), [460](#), [460t](#)

icterus, [313–314](#), [313t](#)

idiotypes, [642](#)

IDL (intermediate-density lipoproteins), [237t](#), [241](#), [254](#), [257](#)

iduronate, [143](#), [145f](#)

IEF (isoelectric focusing), protein and peptide purification with, [26](#), [27f](#)

IgA, [640t](#), [642f](#)

IgD, [640t](#)

IgE, [640t](#)

IGF-1. *See* insulin-like growth factor 1

IgG, [640t](#), [641f](#)

IgM, [640t](#), [642f](#)

IL-1 (interleukin-1), [631](#)

IL-6 (interleukin-6), [635](#)

imatinib, [701–702](#), [702t](#)

immune response

 cancer escape from, [695](#), [695f](#)

 glycoproteins in, [553–554](#)

immune system

 adaptive, [639](#), [643](#), [662](#)

 dysfunctions of, [644–645](#)

 innate, [639](#), [643](#)

immune thrombocytopenic purpura, [654–655](#)

immunoassays

 enzyme-linked, [63](#), [565](#)

 laboratory tests using, [565](#)

immunocompromised state, [644–645](#), [656](#)

immunogenicity, [643](#)

immunoglobulin genes

 amplification and, [429](#)

DNA rearrangement and, 360–361
immunoglobulin light chains, 361, 639, 642
immunoglobulins, 627, 630*t*
 binding specificity of, 640, 643*f*
 class switching and, 642
 class-specific effector functions of, 640–641
 composition of, 639, 640*t*, 641*f*, 642*f*
 diversity of, 641
immunotherapy, for cancer, 698–700
IMP. *See* inosine monophosphate
importins, 577–578, 578*f*
in situ hybridization, 441
inactive chromatin, 354, 418
inborn errors of metabolism
 of amino acid metabolism, 276–278, 277*t*, 280–281, 293, 294*t*
 early studies on, 2
 gene or protein modification for, 278
 general features of, 276–277
 mucopolysaccharidoses, 603–604, 604*t*
 neonate screening for, 565–566
 tandem mass spectrometry in screening for, 278, 280
 urea cycle defects, 276–278, 277*t*
inclusion cell (I-cell) disease, 478, 478*t*, 554, 585*t*
indels, 359, 398
indirect bilirubin, 313
indirect carcinogens, 559
indispensable amino acids. *See* essential amino acids
indole, permeability coefficient of, 463*f*
indomethacin, cyclooxygenases affected by, 226
induced fit model, 60, 60*f*
induced pluripotent stem cells (iPSCs), 446
inducers, 84
 gratuitous, 412
 in regulation of gene expression, 411
inducible gene, 411
induction, of enzyme synthesis, 84
infant respiratory distress syndrome (IRDS), 234

infantile Refsum disease, [580](#), [580t](#)
infectious disease
 enzymes for diagnosis of, [64–65](#)
 glycoprotein role in, [555](#)
 kwashiorkor after, [525](#)
 protein loss in, [526](#)
 undernutrition in, [525](#)
inflammasome, [700](#)
inflammation
 advanced glycation end-products in, [553](#)
 cancer development and, [700](#)
 glycoprotein role in, [553–554](#)
 plasma proteins in, [630–631](#), [630t](#)
 prostaglandins in, [216](#)
inflammatory response, [511](#), [656](#)
influenza virus A, glycans in binding of, [555](#)
information pathway, [502](#), [502f](#)
inhibitor-1, [168](#), [170](#)
inhibitors
 of angiogenesis, [697–698](#)
 competitive, [76–78](#), [77f](#), [78f](#)
 of DNA methyltransferases, [690](#)
 drugs acting as, [80](#)
 feedback, [85–86](#), [85f](#), [89](#)
 of folic acid metabolism, [537](#)
 of histone deacetylases, [690](#)
 irreversible, [78](#)
 kinetic analysis of, [76–79](#), [77f](#), [78f](#)
 mechanism-based, [76](#), [78–79](#)
 noncompetitive, [77–78](#), [77f](#), [78f](#)
 of platelet activation, [671f](#), [672](#)
 of pyruvate dehydrogenase, [161–163](#), [162f](#)
 of respiratory chain, [112](#), [118](#), [123–124](#), [123f](#), [124f](#)
 of thrombin, [677–678](#)
 tightly bound, [78](#)
 of tyrosine kinases, [701–702](#), [702t](#)
inhibitors of apoptosis (IAPs), [693f](#), [694](#)

initial velocity (v_i), [73–76](#), [73f](#), [75f](#), [76f](#), [79](#), [80f](#)

initiation

- in DNA synthesis, [363–364](#), [365f](#), [366f](#)
- in protein synthesis, [399–402](#), [400f](#)
- in RNA synthesis, [375–378](#), [376f](#), [377f](#)

43S initiation complex, in protein synthesis, [399](#), [400f](#)

48S initiation complex, in protein synthesis, [399](#), [400f](#), [401](#)

80S initiation complex, in protein synthesis, [399](#), [400f](#), [401](#)

initiation complexes, in protein synthesis, [399](#), [400f](#)

initiator methionyl-tRNA, [399](#), [400f](#)

initiator sequence (Inr), [380](#)

initiators, of apoptosis, [692–694](#), [693f](#)

innate immune system, [639](#), [643](#)

innate immunity, glycoproteins in, [554](#)

inner membrane, of mitochondria, [118](#), [118f](#), [119f](#)

- selective permeability of, [124–126](#), [124f](#), [125f](#), [126f](#)

inner mitochondrial membrane, [576](#)

inorganic elements, human requirement for, [93](#), [93t](#)

inorganic pyrophosphatase, [109](#), [109f](#)

inorganic pyrophosphate (PP_i), [109](#), [109f](#)

inosine monophosphate (IMP)

- conversion to AMP and GMP, [328](#), [330f](#), [331](#), [331f](#)
- synthesis of, [328–330](#), [329f](#), [330f](#)

inositol phospholipids, [229](#)

inositol trisphosphate, [200](#)

1,4,5-inositol trisphosphate (IP_3)

- in chemotaxis, [658](#)
- in platelet aggregation, [670](#), [671f](#)

Inr (initiator sequence), [380](#)

insertions of nucleotides, [397–398](#), [398f](#)

inside-out transmembrane signaling, in platelet aggregation, [670](#), [671f](#)

inside-outside asymmetry, membrane, [464](#)

Insig (insulin-induced gene), [252](#)

insulators

- in gene expression, [424–425](#)
- nonpolar lipids as, [196](#)

insulin

- adipose tissue metabolism affected by, 245
 - biological assay to measure, 719, 720t
 - blood glucose regulation by, 179, 179t
 - in cholesterol synthesis, 252–253, 253f
 - in diabetes mellitus, 130, 140
 - free fatty acids affected by, 236, 245
 - gene location of, 442t
 - glucose regulation by, 136–138, 158
 - in glucose transport, 469–470
 - glycogen regulation by, 168, 170
 - in glycolysis and gluconeogenesis regulation, 175
 - kinase cascade signal transmission by, 508, 509f
 - in lipogenesis regulation, 221–222, 222f
 - in lipolysis regulation, 222, 245–246, 245f, 246f
 - protein synthesis initiation by, 402, 402f
 - radioimmunoassay to measure, 719, 720t
 - receptor for, 482
 - secretion by rabbit pancreas, 726t
 - sequencing of, 26–27
 - storage of, 497, 497t
 - synthesis of, 493–494, 494f
 - VLDL secretion and, 243
- insulin receptor substrates (IRS), 508, 509f
- insulin resistance, glycoprotein role in, 553
- insulin/glucagon ratio, in ketogenesis regulation, 214
- insulin-induced gene (Insig), 252
- insulin-like growth factor 1 (IGF-1), 482
- in insulin signal generation, 508, 509f
- integral membrane proteins, 34
- integral proteins, 464–465, 464f
- integration, chromosomal, 359–360, 360f
- integrins, 554, 658–659, 659t
- intercellular communication, 480. *See also* endocrine system
- intercostal skeletal muscle cells, turnover of, 708t
- β -interferon gene, 422, 423f
- interferons, 662

interleukin-1 (IL-1), [631](#)
interleukin-6 (IL-6), [635](#)
interleukins, [662](#), [700](#)
intermediate filaments, [625](#), [625t](#)
intermediate-density lipoproteins (IDL), [237t](#), [241](#), [254](#), [257](#)
intermembrane mitochondrial space, proteins in, [576](#)
intermembrane space, of mitochondria, [118](#), [118f](#)
intermittent branched-chain ketonuria, [290](#)
internal ribosomal entry site (IRES), [405–406](#), [406f](#)
interphase chromosomes, [353](#)
intervening sequences. *See* introns
intestinal epithelium turnover, [708t](#)
intestines. *See also* absorption
 monosaccharide absorption in, [520](#), [520f](#)
 transition metal absorption in, [101](#)
intracellular environment, membranes in maintenance of, [460](#), [460t](#)
intracellular fluid (ICF), [460](#), [460t](#)
intracellular membranes, [459](#)
intracellular signals, [502](#). *See also* second messengers
intracellular traffic. *See also* protein sorting
 disorders of, [580t](#), [589–590](#)
 of proteins, [573](#)
 transport vesicles in, [585–588](#), [586t](#), [587f](#)
intravasation, of cancer cells, [698](#), [699f](#)
intrinsic factor, [101](#), [536](#)
intrinsic pathway, [672–674](#), [672f](#), [673f](#), [673t](#), [674t](#)
intrinsic tenase complex, [674](#)
introns (intervening sequences), [356](#), [357f](#), [361](#)
 description of, [386](#)
 processing of, [387f](#), [393–394](#)
 removal from primary transcript, [386–388](#), [387f](#), [388f](#)
 removal of, [386–388](#), [387f](#), [388f](#)
inulin, [146](#), [148f](#)
invert sugar, [145](#)
iodine (iodide)
 deficiency of, [492](#)
 human requirement for, [93](#), [93t](#)

- metabolism of, 492
- 5-iodo-2'-deoxyuridine, 324*f*
- iodoacetate, 160*f*
- iodopsin, 529
- iodothyronyl residues, 492
- 5-iodouracil, 324
- ion channels, 459, 468*t*
 - function of, 470, 470*f*
 - K⁺ channel, 471, 471*f*
 - mutations and, 478
 - nerve impulses and, 473
 - properties of, 471*t*
 - selectivity of, 470
- ion product, 10
- ion transport, in mitochondria, 126
- ion trap, 30
- ion-exchange chromatography, protein and peptide purification with, 25
- ionization
 - of amino acids, 18–20, 19*f*, 20*t*
 - of water, 9–10
- ionizing radiation, DNA damage caused by, 370*f*, 370*t*
- ionophores, 471–472
 - mitochondrial, 125
- ion-specific electrodes, 564
- IP₃. *See* 1,4,5-inositol trisphosphate
- iproniazid, 300
- iPSCs (induced pluripotent stem cells), 446
- IPTG (isopropylthiogalactoside), 412
- IRDS (infant respiratory distress syndrome), 234
- IREG1 (iron-regulated protein 1), 632
- IRES (internal ribosomal entry site), 405–406, 406*f*
- iron
 - absorption of, 101, 523–524, 523*f*
 - conservation of, 632–634, 632*f*, 632*t*
 - in cytochrome oxidase, 97
 - in cytochromes P450, 115, 115*f*

deficiency of, 636, 637t
heavy metal displacement of, 94
in heme, 48–49, 48f, 49f, 53–54, 95–97
from heme catabolism, 311
human requirement for, 93, 93t
intracellular homeostasis, 634–635, 635f, 636f, 637f
macrophage recycling of, 631, 631f
multivalent states of, 93, 94f, 94t
overload, 633, 636, 638t
oxidation of heme, 649–651, 650f, 650t, 651f
physiologic roles of, 97–98, 97f, 98f
regulation of, 94
in sulfite oxidase, 100, 100f
toxicity of, 95t
transferrin cycle, 633, 634f
iron deficiency anemia, 636, 637t, 650t
iron porphyrins, 305. *See also* heme
iron response elements, 634–635
iron toxicity, 475
iron-regulated protein 1 (IREG1), 632
iron-sulfur (Fe-S) proteins, in respiratory chain complexes, 118–120, 119f
irreversible inhibitors, 78
IRS (insulin receptor substrates), 508, 509f
ischemia, 157, 478
isoaspartyl linkage in polypeptide backbone, 715f
isoaspartyl methyltransferase, 715f
isocitrate, in citric acid cycle, 151–152, 152f
isocitrate dehydrogenase
 in citric acid cycle, 152, 152f
 in NADPH production, 218, 219f, 220f
 regulation of, 156
isoelectric focusing (IEF), protein and peptide purification with, 26, 27f
isoelectric pH (pI), of amino acids, 19
isoleucine, 15t
 carbon skeleton catabolism of, 288, 290, 292f, 293, 293f, 293t
 synthesis of, 266–267
isomaltose, 146f, 146t

isomerases, [57](#)
isomerism
 geometric, of unsaturated fatty acids, [198](#), [198f](#)
 of monosaccharides, [142–143](#), [143f](#), [144f](#)
isomerization, of folding proteins, [41–42](#), [42f](#)
isomorphous displacement, [40](#)
isoniazid, [559](#)
isopentenyl diphosphate, in cholesterol synthesis, [250](#), [251f](#)
isopentenyl diphosphate isomerase, [251f](#)
isoprene units, polyprenoids synthesized from, [203](#), [204f](#)
isoprenoid units, [250](#), [251f](#), [252f](#)
isopropylthiogalactoside (IPTG), [412](#)
isoprostanes, [204](#)
isosteric effectors, [86](#)
isothermic systems, [105](#)
isotypes, [642](#)
isovaleric acidemia, [290](#), [293](#)
isovaleryl-CoA dehydrogenase, deficiency of, [290](#), [292f](#), [293](#)
isozymes, [61–62](#)

J

Jak/STAT pathway, [508–509](#), [510f](#)
Jamaican vomiting sickness, [215](#)
jaundice
 hyperbilirubinemia causing, [305](#), [313–314](#), [313t](#)
 laboratory tests for, [566](#)
 metabolic disorders underlying, [314–315](#), [314f](#), [315t](#)
 obstructive, [242](#)
“jumping DNA,” [360](#)
junctional diversity, [641](#)

K

k. See rate constant
 K^+ . See potassium
 K^+ channel (KvAP), [471](#), [471f](#)
Kartagener syndrome, [625](#)
karyopherins, [578](#)

karyotype, [356f](#)
 k_{cat} . See catalytic constant
 $k_{\text{cat}}/K_{\text{m}}$. See catalytic efficiency
 K_{d} . See dissociation constant
kDEL-containing proteins, [574t](#), [583](#)
 K_{eq} . See equilibrium constant
keratan sulfate I, [599](#), [601f](#), [602](#), [602t](#)
keratan sulfate II, [599](#), [601f](#), [602](#), [602t](#)
keratins, [625](#), [625t](#)
kernicterus, [313–314](#)
 α -ketoacid decarboxylase complex, deficiency of, [290](#), [292f](#), [293](#), [293t](#)
ketoacidosis, [140](#), [207](#), [215](#)
3-ketoacyl enzyme, [217](#), [219f](#)
3-ketoacyl reductase, [219f](#)
3-ketoacyl synthase, [217](#), [219f](#)
3-ketoacyl-CoA thiolase deficiency, [215](#)
ketoamines, in diabetes mellitus, [553](#), [553f](#)
ketogenesis, [133](#)
 high rates of fatty acid oxidation and, [210–213](#), [211f](#), [212f](#), [213f](#)
 HMG-CoA in, [211](#), [212f](#)
 regulation of, [213–214](#), [213f](#), [214f](#)
ketogenic amino acids, [136](#)
 α -ketoglutarate
 arginine and ornithine formation of, [282](#), [283f](#)
 in citric acid cycle, [152–153](#), [152f](#)
 glutamine and glutamate formation of, [282](#)
 histidine formation of, [282](#), [283f](#)
 in transamination reactions, [272–273](#), [273f](#)
 α -ketoglutarate dehydrogenase complex
 in citric acid cycle, [152–153](#), [152f](#)
 regulation of, [156](#)
ketone bodies, [207](#), [210](#), [211f](#)
 brain use of, [136](#)
 free fatty acids as precursors of, [213](#), [213f](#)
 as fuel for extrahepatic tissues, [211](#), [213](#), [213f](#)
 metabolic pathways of, [131](#), [131f](#), [133](#), [136](#)

in fasting state, 138–139, 138t
ketonemia, 213, 215
ketonuria, 215, 290, 293, 293t
ketoses, 141–142, 142t, 143, 144f
ketosis, 139–140, 207, 211, 213, 215, 244
kidney
 basement membrane of, 603
 blood glucose threshold of, 180
 calcitriol synthesis in, 490–491, 490f
 vitamin D metabolism in, 530–531, 531f
kidney function tests, 566
kinesin, 624
kinetic order, 71
kinetic theory, 70
kinetics, enzyme. *See* enzyme kinetics
kinetochore, 355
 K_m . *See* Michaelis constant
Korsakoff psychosis, 534
Kozak consensus sequences, 401
Krabbe disease, 235t
Krebs cycle. *See* citric acid cycle
Ku70/80, 370, 371f
KvAP (voltage-gated K^+ channel), 471, 471f
kwashiorkor, 263–264, 524–525
kynureninase, 288, 289f
kynurenine formylase, 288, 289f
kynurenine-anthranilate pathway, 286–288, 289f, 290f

L

laboratory tests
 biomedical importance of, 560
 for cancer, 700–701, 701t
 causes of abnormal results of, 560
 clinical value of, 562–563, 563t
 enzymes used in, 63–65, 64t, 65f, 564–565, 564f
 for hemostasis, 679
 of organ function, 566–567

reference range of, 561
samples for, 563
techniques used in, 563–566, 564f
validity of, 561–563, 561f, 562f, 563t

lac operon, 411–412, 411f, 413f, 414
lac repressor, 411–412, 413f
lacA gene, 411–412, 411f, 413f
lacI gene, 411–412, 411f, 413f, 414
 β -lactamase, 80, 98, 99f
lactase, 56, 520
lactate
 in citric acid cycle, 154, 154f
 glucose derived from, 177, 178f
 glycolysis production of, 157, 158f, 158t, 160
lactate dehydrogenase
 diagnostic use of, 64, 64t, 65f
 pyruvate reduction by, 160
 structure of, 37, 38f
lactation, glucose requirement of, 136
lactic acid, pK_a of, 13t
lactic acid cycle, glucose derived from, 177, 178f
lactic acidosis, 118, 157, 163
 vitamin B₁ deficiency in, 534
lactoferrin, 660t
lactose
 galactose conversion to, 187–188, 189f
 metabolism of, operon hypothesis and, 411–412, 411f, 413f, 414
 physiological importance of, 145, 146f, 146t
lactose intolerance, 519–520
lactose synthase, 188, 189f
lactulose, 147t
lacY gene, 411–412, 411f, 413f
lacZ gene, 411–412, 411f, 413f
lagging (retrograde) strand, in DNA replication, 362f, 363, 366f
 λ repressor (*cI*) gene, 415, 415f
 λ repressor (*cI*) protein, 415–416, 416f

laminin, 598–599, 599*f*
lamins, 355, 625, 625*t*
lanosterol, in cholesterol synthesis, 250, 251*f*, 252*f*
lathyrism, 14, 18, 18*t*
lauric acid, 197*t*
LBD (ligand-binding domain), 511–512, 512*f*
LCAT. *See* lecithin:cholesterol acyltransferase
LCRs (locus control regions), 424–425
LDL. *See* low-density lipoproteins
LDL receptor, 238
 in chylomicron remnant uptake, 240*f*, 241
 in cotranslational insertion, 582–583, 582*f*
 regulation of, 253
LDL-receptor–related protein-1 (LRP-1), 238, 239*f*, 241
lead, toxicity of, 93–94, 306, 309
leading (forward) strand, in DNA replication, 362*f*, 363
lecithin:cholesterol acyltransferase (LCAT), 254
 apolipoprotein role in, 238
 familial deficiency of, 258*t*
 in HDL metabolism, 241*f*, 242
 in phosphoglycerol degradation and remodeling, 232–233
lecithins, 200, 200*f*
lectin pathway, 643, 644*f*
lectins, 147
 glycoprotein purification with, 547
 mannose 6-phosphate receptor proteins, 554
Lepore, 359, 360*f*
leptin, 244
Lesch-Nyhan syndrome, 327, 334–335, 336*t*
leucine, 15*t*
 carbon skeleton catabolism of, 288, 290, 292*f*, 293, 293*f*, 293*t*
 synthesis of, 266–267
leucine zipper motif, 427, 427*f*
leucovorin, 537
leukemias, 655, 656, 701
leukocyte adhesion deficiency II, 554
leukocytes

- communication through effectors, 662
- motility of, 657–659, 657f, 658f, 659t
- multiple types of, 656–657, 657f
- selectins of, 553–554
- turnover of, 708t

leukodystrophy, metachromatic, 235t

leukopenia, 656

leukotriene A₄, 198f

leukotriene B₄, 227

leukotrienes (LTs), 197, 198, 198f, 216, 662

- clinical significance of, 224, 227
- lipoxygenase pathway in formation of, 225, 225f, 227f

Lewis acids, transition metals as, 93

library, 438

life expectancy, 708, 708t

lifespan

- body mass *versus*, 715–716, 716t
- evolution and, 717
- versus* longevity, 707–708

lifestyle changes, cholesterol levels affected by, 257

ligand-binding assays, laboratory tests using, 565

ligand-binding domain (LBD), 511–512, 512f

ligand-gated channels, 470

ligandin, 312, 558

ligand-receptor complex, 501–502, 501f, 501t, 502f

ligases, 57

- DNA, 363t, 364
- ubiquitin, 584, 585f

light, energy source in active transport, 472

light chains, immunoglobulin, 361, 639, 642

LINEs (long interspersed nuclear elements), 357–358

Lineweaver-Burk plot, 74–75, 75f

- for Bi-Bi reactions, 79, 80f
- inhibitor evaluation with, 77, 77f, 78f

O-linked *N*-acetylglucosamine transferase, 552–553

linker DNA, 351f, 353

linoleic acid/linoleate, 196f, 197t
in essential fatty acid deficiency, 224
nutritionally essential, 222, 222f
oxidation of, 211f
synthesis of, 222–223, 223f

α-linolenic acid (ALA), 197t, 199
for essential fatty acid deficiency, 224
nutritionally essential, 222, 222f
synthesis of, 223–224, 223f

γ-linolenic acid, 197t, 223

lipases
diagnostic use of, 64t
insulin and, 245
triacylglycerol hydrolysis of, 521
in triacylglycerol metabolism, 229, 244–245, 245f

lipid bilayer, 462–463, 462f

lipid core, of lipoprotein, 237–238, 238f

lipid droplets, 244, 247

lipid rafts, 200, 466, 466f, 588, 589

lipid storage disorders (lipidoses), 234–235, 235t

lipidomics, 3, 447

lipidoses (lipid storage disorders), 234–235, 235t

lipids. *See also* fatty acids; glycolipids; phospholipids; steroids;
triacylglycerols
amphipathic, 204–205, 205f
biomedical importance of, 196
classification of, 196
complex, 196
derived, 196
digestion and absorption of, 520–521, 522f
disorders associated with abnormalities of, 478
free radical damage to, 541–542, 542f
futile cycling of, 525
in membranes. *See also* membrane lipids
amphipathic, 461–462, 461f
artificial, 465
asymmetry and, 464, 589, 589f

- protein association with, 463
- protein ratio to, 460–461, 460*f*
- as metabolic fuel, 130, 136
- metabolic pathways of, 130–131, 130*f*, 131*f*
 - in fasting state, 138, 138*t*
 - in fed state, 137–138, 137*f*, 138*t*
 - at tissue and organ levels, 133, 133*f*
- metabolism of, in liver, 242–243, 243*f*
- neutral, 196
- peroxidation of, 203–204, 204*f*, 710, 711*f*
- precursor, 196
- simple, 196
- solubility of, 196
- transport and storage of
 - adipose tissue and, 244–245, 245*f*
 - biomedical importance of, 236–237
 - brown adipose tissue and, 247, 247*f*
 - clinical aspects of, 243–244
 - fatty acid deficiency and, 225
 - lipogenesis and, 247
 - lipolysis and, 246, 246*f*
 - as lipoproteins, 237–238, 237*t*, 238*f*
 - liver in, 242–243, 243*f*
 - perilipin and, 247
- lipid-soluble molecules, 462
- lipid-soluble vitamins, 527, 528*t*
- lipins, 230, 231*f*
- lipoamide, 161, 162*f*
- lipogenesis, 132, 133
 - acetyl-CoA for, 218–219, 219*f*, 220*f*
 - adipose tissue and, 247
 - ethanol and, 244
 - fatty acid synthase complex in, 217–218, 217*f*, 218*f*
 - main pathway for, 216–217
 - malonyl-CoA production in, 217, 217*f*
 - NADPH for, 218, 220*f*
 - regulation of

- enzymes in, 217–218, 221, 221*f*, 222*f*
- nutritional state in, 220
- short- and long-term mechanisms in, 220–222, 221*f*, 222*f*

lipolysis, 133

- hormone regulation of, 245–247, 246*f*
- insulin inhibition of, 222
- lipase in, 244–245, 245*f*
- of triacylglycerol, 229

lipophilic hormones, 482, 483*t*

lipoprotein lipase, 133

- apolipoprotein role in, 238
- familial deficiency of, 258*t*
- hydrolysis by, 240, 240*f*

lipoprotein(a) excess, familial, 258*t*

lipoproteins, 34, 133, 133*f*, 628, 630*t*

- apolipoproteins in, 237*t*, 238
- carbohydrates in, 147
- in cholesterol transport, 253–254, 255*f*
- classification of, 237, 237*t*
- deficiency of, fatty liver and, 244
- disorders of, 257, 258*t*
- formation of, 236
- fructose effects on, 186, 188*f*, 189–190
- remnant, 237*t*, 240*f*, 241
- structure of, 237–238, 238*f*
- vitamin E in, 532

α -lipoproteins. *See also* high-density lipoproteins

- familial deficiency of, 258*t*

β -lipoproteins. *See* low-density lipoproteins

liposomes

- amphipathic lipids forming, 204–205, 205*f*
- artificial membranes and, 465

lipotropic factor, 244

lipoxin A₄, 198*f*

lipoxins (LXs), 197, 198, 198*f*, 216, 224, 225

- clinical significance of, 227
- lipoxygenase pathway in formation of, 225, 225*f*, 227*f*

lipoxygenase, 225, 227f
 reactive species produced by, 204
5-lipoxygenase, 225, 227, 227f
lipoxygenase pathway, 198, 224, 225, 225f, 227f
liquid chromatography
 laboratory tests using, 564
 protein and peptide purification with, 24, 25f
lithocholic acid, synthesis of, 255, 256f
liver
 amino acid levels and, 271–272, 271f, 272f
 bilirubin metabolism of, 311–313, 312f, 313f
 blood glucose regulation by, 178, 178t
 calcitriol synthesis in, 490, 490f
 carbohydrate metabolism enzyme induction and repression in, 174–175, 175t
 cirrhosis of, 243, 244
 citric acid cycle in, 150
 cytochromes P450 in, 557
 failure of, 243
 in fasting state, 130, 138–139, 138t, 139f, 139t
 fatty. *See* fatty liver
 in fed state, 130, 136–138, 137f, 138t
 fructose 2,6-bisphosphate in, 176, 177f
 fructose effects in, 186, 188f, 189–190
 glucose uptake by, 136–137, 137f
 glycogen in, 164, 165t
 glycogen phosphorylase regulation in, 167
 glycogenesis in, 164–166, 165f, 166f
 glycogenolysis in, 166, 168
 heme synthesis in, 306–308
 metabolic role of, 132–133, 132f
 metabolism in
 chylomicrons and VLDL, 240
 fatty acid oxidation and ketogenesis, 210–213, 211f, 212f, 213f
 of lipids, 242
 plasma protein synthesis in, 628–629
 remnant lipoprotein uptake by, 239f, 241

- vitamin D metabolism in, [530–531](#), [531f](#)
- VLDL formation and secretion in, [242–243](#), [243f](#)
- liver function tests, [566](#)
- LMWHs (low-molecular-weight heparins), [677](#)
- lncRNAs (long noncoding RNAs), [348](#), [374](#), [375t](#)
- locus control regions (LCRs), [424–425](#)
- long interspersed nuclear elements (LINEs), [357–358](#)
- long noncoding RNAs (lncRNAs), [348](#), [374](#), [375t](#)
- long-chain ω 3 fatty acids, [196](#), [199](#)
- longevity versus lifespan, [707–708](#)
- looped domains, chromatin, [352f](#), [353](#), [355](#)
- loops, in proteins, [36](#), [37f](#)
- low-density lipoproteins (LDL), [237](#), [237t](#)
 - advanced glycation end-products and, [553](#)
 - apolipoproteins of, [238](#)
 - atherosclerosis and, [241](#), [257](#)
 - cholesterol supply with, [249](#)
 - endocytosis of, [475](#)
 - HDL ratio to, [257](#)
 - metabolism of, [240f](#), [241](#)
 - receptors for. *See* LDL receptor
 - regulation of, [253](#)
- Lowe oculocerebrorenal syndrome, [585t](#)
- low-energy phosphates, [107](#)
- low-molecular-weight heparins (LMWHs), [677](#)
- LRP-1 (LDL-receptor-related protein-1), [238](#), [239f](#), [241](#)
- LTs. *See* leukotrienes
- lung surfactant, [200](#), [229](#), [234](#)
- LXs. *See* lipoxins
- LXXLL motifs, [514](#)
- lyases, [57](#)
- lymphocyte homing, glycoprotein role in, [553–554](#)
- lymphocytes, [657](#), [662](#)
- lymphoid progenitor cells, [657](#)
- lysine, [16t](#), [286](#), [288f](#)
- lysine acetyltransferases, [89](#)
- lysine hydroxylase, vitamin C as coenzyme for, [539](#)

lysogenic pathway, [414f](#), [415](#)
lysolecithin, [201](#), [201f](#), [232–233](#), [233f](#), [241f](#), [242](#)
lysophosphatidylcholine, [201](#), [201f](#), [232–233](#), [233f](#)
lysophospholipase, [232](#), [233f](#)
lysophospholipids, [201](#), [201f](#), [478](#)
lysosomal degradation pathway, [235](#)
lysosomal enzymes in I-cell disease, [478](#), [478t](#)
lysosomal hydrolases, glycoprotein, [554–555](#)
lysosomal proteases, in protein degradation, [584–585](#)
lysosomal proteins, [590](#)
lysosomes
 in endocytosis, [474](#)
 faulty targeting of enzymes into, [554](#)
 glycogen hydrolysis by, [166](#)
 protein sorting signals in, [573](#), [574t](#)
lysozyme, [660t](#)
 structure of, [37f](#)
lysyl hydroxylases, [43](#), [266](#), [593](#), [596](#), [596t](#)
lysyl oxidase, [43](#), [594](#), [596](#)
 copper in, [100](#)
lytic pathway, [414f](#), [415](#)
lytic/lysogenic genetic switching event, [415](#), [415f](#)

M

M phase, [368](#), [368f](#), [369f](#)
mAbs (monoclonal antibodies), [642–643](#), [697–698](#), [702](#), [702t](#)
MAC (membrane attack complex), [643](#)
 α_2 -macroglobulin, [638](#), [638f](#), [662](#), [677](#)
macromolecules
 cell nucleus transport of, [575f](#), [576–579](#), [577t](#), [578f](#)
 cellular transport of, [474–475](#), [474f](#), [475f](#)
 mitochondria import of, [576](#), [577f](#), [577t](#)
macrophages, [656](#), [657](#), [660](#), [662](#)
 iron recycling by, [631](#), [631f](#)
magnesium (Mg^{2+})
 in extracellular and intracellular fluid, [460](#), [460t](#)
 porphyrins containing, [305](#)

Maillard reaction, [553](#), [553f](#)
major groove, in DNA, [340f](#), [341](#)
 helix-turn-helix motif and, [425–426](#), [426f](#)
 operon model and, [412](#)
major histocompatibility complex (MHC), [584](#), [659](#)
major sorting decision, [574](#)
malaria, glycan role in, [555](#)
malate
 in citric acid cycle, [152f](#), [153](#)
 in lipogenesis, [218](#), [220f](#)
malate dehydrogenase, in citric acid cycle, [152f](#), [153](#)
malate shuttle, [125–126](#), [125f](#)
MALDI (matrix-assisted laser desorption and ionization), [29–30](#), [30f](#)
malic enzyme, in NADPH production, [218](#), [219f](#), [220f](#)
malignancy. *See* cancer
malignant hyperthermia (MH), [618–619](#), [620t](#)
malonate, [77](#), [123](#)
malonyl acetyl transacylase, [217](#), [217f](#), [219f](#)
malonyl-CoA
 CPT-I regulation by, [213–214](#), [214f](#)
 in fatty acid synthesis, [217](#), [217f](#)
maltose, physiological importance of, [145](#), [146f](#), [146t](#)
mammalian coregulator proteins, [514t](#)
mammalian DNA-dependent RNA polymerases, [378](#), [378t](#)
mammalian viral cloning vectors, [437–438](#)
manganese
 human requirement for, [93](#), [93t](#)
 multivalent states of, [93](#), [94f](#), [94t](#)
 physiologic roles of, [98](#)
 toxicity of, [95t](#)
mannan-binding protein (MBP), [643](#)
mannosamine, [145](#), [188](#), [190f](#)
mannose, [143](#), [144f](#), [144t](#), [548t](#)
mannose 6-phosphate, [554](#)
mannose-6-phosphate, [475](#), [574t](#)
mannose-binding lectin (MBL), [643–644](#), [644f](#)
mannose-binding protein, [554](#)

mannosidosis, 554–555
manual enzymatic Sanger method, 439, 440*f*
MAPK (mitogen-activated protein kinase) pathway, 508, 509*f*
maple syrup urine disease (MSUD), 290, 293, 293*t*
marasmus, 105, 263–264, 524–525
Marfan syndrome, 597, 597*f*
Maroteaux-Lamy syndrome, 604*t*
mass spectrometry (MS)
 metabolic disease detection with, 278
 protein analysis using, 28–30, 28*t*, 29*f*, 30*f*
 proteomics with, 447
 spectrometer configurations used for, 28–30, 29*f*, 30*f*
 tandem, 30, 278, 280
 volatilization methods for, 29–30, 30*f*
mast cells, 602, 656, 662
MAT (methionine adenosyltransferase), 298, 299*f*
matrix, mitochondrial, 118, 118*f*, 151
matrix metalloproteinases (MMPs), 698
matrix protease, 576
matrix proteins, 576, 579
matrix-assisted laser desorption and ionization (MALDI), 29–30, 30*f*
maximal velocity (V_{\max}), 73–76, 73*f*, 75*f*, 76*f*
 allosteric effects on, 86
 in Bi-Bi reactions, 79, 80*f*
 inhibitor effects on, 77–78, 77*f*, 78*f*
MBL (mannose-binding lectin), 643–644, 644*f*
MBP (mannan-binding protein), 643
MDR (multidrug resistance), 478
MDR-1 protein (multidrug-resistance-1 protein), 472
mechanically gated channels, 470
mechanism-based inhibitors, 76, 78–79
mediator (Med) proteins, 384, 385*f*
medicine
 biochemical research impacts on, 2–3
 biochemistry importance to, 1
 biochemistry interrelationship with, 2, 2*f*
 Human Genome Project impact on, 3–4, 3*f*

- personalized, 432
- medium-chain acyl-CoA dehydrogenase, deficiency of, 215
- megaloblastic anemias, 538, 650*t*
- MELAS (mitochondrial encephalopathy, lactic acidosis, and stroke), 126
- melatonin, tryptophan conversion to, 300, 301*f*
- melting temperature. *See* transition temperature
- membrane attack complex (MAC), 643
- membrane fatty acid transport protein, 238
- membrane fusion, 586
- membrane lipids
 - bilayers of, 462–463, 462*f*
 - cholesterol in, 461
 - glycosphingolipids in, 461
 - phospholipids in, 199–201, 200*f*, 461, 461*f*
 - sterols in, 461
 - turnover of, 589
- membrane proteins
 - differences in, 463, 463*t*
 - integral, 34, 464–465, 464*f*
 - lipid bilayer and, 463
 - mutations of, diseases caused by, 478, 478*t*
 - peripheral, 464–465, 464*f*
 - structure of, dynamic, 463–464
 - turnover of, 589
- membrane-bound polyribosomes, 580
- membranes
 - artificial, 465
 - assembly of, 574, 588–590, 589*f*, 590*t*
 - asymmetry of, 460, 464, 589, 589*f*
 - biomedical importance of, 459
 - depolarization of, in nerve impulse transmission, 473
 - fluidity affecting, 465–466
 - gap junctions, 459, 476, 476*f*
 - Golgi apparatus in synthesis of, 574
 - intracellular, 460
 - mitochondrial, 118, 118*f*, 119*f*, 576, 577*f*
 - selective permeability of, 124–126, 124*f*, 125*f*, 126*f*

phase changes of, 465–466
of red blood cells, 651–653, 651f, 652f, 652t
selectivity of, 467t. *See also* transporters and transport systems
 aquaporins, 472
 facilitated diffusion, 469–470, 469f
 ion channels, 470–471, 470f, 471f, 471t
 ionophores, 471–472
 mechanisms of, 467–468
 passive diffusion, 467–468, 467f, 467t, 468f, 468t
 transporters, 468–469, 468f, 469f
signal transmission across, 459, 467t, 475–476
structure of
 asymmetry and, 464
 fluid mosaic model of, 465–466, 466f
 lipids in, 204–205, 205f, 461–463, 461f, 462f
 protein:lipid ratio in, 460–461, 460f
menadione, 528t, 532–533, 533f
menaquinones, 528t, 532–533, 533f
Menkes syndrome, 43, 263, 596
MEOS (microsomal ethanol oxidizing system), 244
6-mercaptopurine, 324f, 325, 329f, 330
3-mercaptopyruvate pathway, 283, 284f
mercury, toxicity of, 93–94
meromyosin, 614
merosin, 598, 623f
messenger RNA (mRNA), 343, 374, 375t
 alternative splicing and, 388, 388f
 amplification of, 429, 429f
 chemical characteristics of, 344–345, 345f
 codon assignments in, 393–395, 394t
 editing of, 391
 function of, 344, 344f
 gene expression modulation and, 428–429
 in genetic information flow, 393–394
 modification of, 389–390
 nontranslating, 405, 405f
 nucleotide sequence of, 394, 394t

- mutations caused by changes in, [397–398](#), [398f](#)
- polycistronic, [411](#)
- precursors, [345–346](#), [356](#)
- processing of, [386–388](#), [387f](#)
- in protein synthesis
 - elongation, [402–403](#), [402f](#)
 - initiation, [399](#), [400f](#), [401–402](#), [401f](#)
 - termination, [403–404](#)
- relationship to chromosomal DNA, [357f](#)
- stability of, [430](#), [430f](#)
- transcription starting point and, [376](#)
- translocation of, [578](#)
- MET (metabolic equivalent), [524](#)
- metabolic acidosis, ammonia role in, [275](#)
- metabolic alkalosis, ammonia effects on, [275](#)
- metabolic disorders
 - of amino acid metabolism, [276–278](#), [277t](#), [280–281](#), [293](#), [294t](#)
 - of bilirubin metabolism, [314–315](#), [314f](#), [315t](#)
 - early studies on, [2](#)
 - gene or protein modification for, [278](#)
 - general features of, [276–277](#)
 - neonate screening for, [565–566](#)
 - tandem mass spectrometry in screening for, [278](#), [280](#)
 - urea cycle defects, [276–278](#), [277t](#)
- metabolic equivalent (MET), [524](#)
- metabolic fuels
 - in fasting state, [130](#), [138–139](#), [138t](#), [139f](#), [139t](#)
 - in fed state, [130](#), [136–138](#), [137f](#), [138t](#)
 - human intake of, [129–130](#)
 - interconvertible nature of, [136](#)
 - processing of, [130–131](#), [130f](#), [131f](#), [132f](#)
- metabolic rate, [105](#), [524](#)
- metabolic regulation
 - active or passive, [83](#), [83f](#)
 - allosteric, [85–86](#), [85f](#), [135–136](#), [135f](#)
 - biomedical importance of, [82–83](#)
 - compartmentation role in, [83–84](#)

control networks of, 90, 90*f*
 covalent modifications in, 85–90, 88*f*, 89*t*
 of enzyme quantity, 84–85
 flux-generating reactions in, 135
 hormones in, 86, 135–136, 135*f*
 multiple mechanisms of, 85
 nonequilibrium reactions as control points in, 135
 proenzymes in, 87–88, 88*f*
 rate-limiting enzymes as targets of, 84
 second messengers in, 86
 metabolic syndrome, 180
 metabolic theories of aging, 715–716, 716*t*
 metabolism, 106
 amino acid roles in, 18
 biomedical importance of, 129–130
 in cancer cells, 695–696, 697*f*, 698*t*
 citric acid cycle as pivotal pathway in, 153–156, 154*f*, 155*f*
 clinical aspects of, 139–140
 CNS and erythrocyte glucose requirements and, 136
 drug. *See* drug metabolism
 energy requirements for, 129–130
 in fasting state, 130, 138–139, 138*t*, 139*f*, 139*t*
 in fed state, 130, 136–138, 137*f*, 138*t*
 free energy changes of. *See* bioenergetics
 fructose effects on, 186, 188*f*, 189–190
 group transfer reactions in, 9
 inborn errors of, 2
 interconvertible fuels in, 136
 normal, 129
 nucleophiles and electrophiles in, 8
 pathways for processing products of digestion, 130–131, 130*f*, 131*f*,
 132*f*
 regulation of. *See* metabolic regulation
 regulation of metabolite flux through, 135–136, 135*f*
 subcellular level of, 132, 134, 134*f*
 tissue and organ level of, 132–133, 132*f*, 133*f*
 metabolites, flux of, 83, 83*f*, 89, 135–136, 135*f*

metabolomics, [3](#), [447](#), [564](#)
metabonomics, [564](#)
metachromatic leukodystrophy, [235t](#)
metal ions. *See also* transition metals
 in enzyme prosthetic groups, [58](#)
 heavy metal displacement of, [93–94](#)
metal-activated enzymes, [58](#)
metalloenzymes, [58](#)
metalloproteins, [34](#)
 physiologic roles of, [97–101](#), [97f](#), [98f](#), [99f](#), [100f](#)
 transition metals in, [95–97](#), [95f](#), [96f](#), [96t](#), [97f](#)
metaphase chromosomes, [355](#), [355t](#), [356f](#)
metastasis
 mechanisms of, [698](#), [699f](#), [700t](#)
 membrane abnormalities and, [478t](#)
 tumor microenvironment role in, [694–695](#), [695f](#)
meteorites, extraterrestrial amino acids in, [17–18](#)
methacrylyl-CoA, catabolism of, [292f](#), [293f](#)
methane monooxygenase, iron in, [97](#)
methemoglobin, [53–54](#), [649](#)
methemoglobin reductase, [54](#)
methemoglobinemia, [649](#), [650t](#)
methionine, [16t](#)
 in S-adenosylmethionine, [323f](#), [324t](#)
 carbon skeleton catabolism of, [288](#), [290f](#), [291f](#)
 specialized products of, [298–299](#), [299f](#), [300f](#), [301](#), [302f](#)
methionine adenosyltransferase (MAT), [298](#), [299f](#)
methionine synthase, vitamin B₁₂ dependency of, [536](#), [536f](#), [538](#)
methionyl-tRNA (met-tRNA), [399](#), [400f](#)
methotrexate, [333–334](#), [537](#)
l-β-methylaminoalanine, [18](#), [18t](#)
methylation
 of deoxycytidine residues, [418–419](#)
 enzyme regulation by, [86–87](#)
 of histones, [351](#), [353t](#)
 mass spectrometry detection of, [28t](#)
 of xenobiotics, [558–559](#)

β -methylcrotonyl-CoA, catabolism of, 292f
5-methylcytosine, 321, 323f
methylene bridges, in porphyrinogens, 306–307
N-methylglycine, 300–301
7-methylguanine, 323f
7-methylguanosine cap structure, mRNA, 389
3-methylhistidine, 298
methylmalonic aciduria, 174, 174f
methylmalonyl-CoA mutase, 174, 174f, 536
methylmalonyl-CoA racemase, 174, 174f
methylxanthines, 246
methyne bridges, in heme, 48, 48f
met-tRNA (methionyl-tRNA), 399, 400f
mevalonate, synthesis of, 250, 250f, 251f
mevalonate kinase, 251f
Mg²⁺. *See* magnesium
MH (malignant hyperthermia), 618–619, 620t
MHC (major histocompatibility complex), 584, 659
MI. *See* myocardial infarction
micelles, 204–205, 205f, 462, 462f, 521
Michaelis constant (K_m), 73f, 74–76, 75f
 allosteric effects on, 86
 in Bi-Bi reactions, 79, 80f
 cellular substrate concentrations and, 83
 inhibitor effects on, 77–78, 77f, 78f
Michaelis constant, of glutathione reductase, 721
Michaelis-Menten equation, 73–76, 73f, 75f
 for Bi-Bi reactions, 79, 80f
microalbuminuria, 566
microbial toxins, 472
microcystin, 14
microfibrils, 597
microfilaments, 623–624
 β_2 -microglobulin, 635, 637f, 639
microheterogeneity, of glycoproteins, 546
micronutrients. *See also* minerals; vitamins

- biomedical importance of, [527](#)
- lipid storage of, [196](#)
- nutritional requirements for, [527–528](#)
- toxic levels of, [527](#)
- transition metals, [93](#), [93t](#)
- micro-RNAs (miRNAs), [347](#), [374](#), [375t](#), [390–391](#)
 - in cancer, [689–690](#)
 - gene expression modulation by, [428–429](#)
 - transcription of, [389–390](#), [390f](#)
- microsatellite instability, [358](#)
 - in cancer, [692](#), [692f](#)
- microsatellite polymorphisms, [358](#), [445–446](#)
- microsatellite repeat sequences, [358](#)
- microscopy, protein structures solved by, [40](#)
- microsomal elongase system, [220](#), [221f](#)
- microsomal ethanol oxidizing system (MEOS), [244](#)
- microsomal triacylglycerol transfer protein (MTP), [242](#)
- microtubule-associated proteins, [624](#)
- microtubules, [587](#), [624–625](#), [624f](#)
- microvesicles, [476](#)
 - cancer and, [690](#)
- microvilli, [466](#)
- mild sonication, [465](#)
- milk fat synthesis, [240](#)
- mineralocorticoids, synthesis of, [485–486](#), [486f](#)
- minerals
 - biomedical importance of, [527](#)
 - digestion and absorption of, [523–524](#), [523f](#)
 - functions of, [540](#), [540f](#)
 - for health maintenance, [3](#)
 - nutritional requirements for, [527–528](#)
- minor groove, in DNA, [340f](#), [341](#)
- MIPP (multiple inositol polyphosphate phosphatase), [53](#)
- miRNAs. *See* micro-RNAs
- misfolded proteins, endoplasmic reticulum degradation of, [584–586](#), [585f](#), [585t](#)
- mismatch repair (MMR), [369](#), [370f](#), [370t](#)

missense mutations, [396–397](#), [397f](#), [398f](#), [622](#)
MIT (monoiodotyrosine), [492](#), [493f](#)
mitochondria
 apoptosis in, [712](#)
 β -oxidation in, [208–210](#), [208f](#), [209f](#), [210t](#)
 citric acid cycle in, [134](#), [134f](#), [151](#)
 cytochromes P450 in, [557](#)
 enzyme activity of, [725t](#)
 exchange transporters of, [124–126](#), [124f](#), [125f](#), [126f](#)
 fatty acid oxidation in, [207–208](#), [208f](#)
 genes encoded by genome of, [712t](#)
 genetic disorders involving, [126](#)
 membranes and compartments of, [118](#), [118f](#)
 protein sorting signals in, [573](#), [574t](#)
 protein synthesis and import by, [576](#), [577f](#), [577t](#)
 redox damage of, [710](#), [712](#)
 respiratory chain complexes in, [118](#), [119f](#)
mitochondrial branched-chain α -ketoacid dehydrogenase complex, [288](#),
 [290](#), [292f](#)
mitochondrial DNA, [358–359](#), [358f](#), [359t](#)
mitochondrial encephalopathy, lactic acidosis, and stroke (MELAS), [126](#)
mitochondrial genome, [576](#)
mitochondrial glycerol-3-phosphate dehydrogenase, [114](#)
mitochondrial matrix, [576](#), [577f](#)
mitochondrial pathway, of apoptosis, [692–694](#), [693f](#)
mitogen-activated protein kinase (MAPK) pathway, [508](#), [509f](#)
mitotic phase, [368](#), [368f](#), [369f](#)
mitotic spindle, [624](#)
mixed-function oxidases, [115](#)
MMPs (matrix metalloproteinases), [698](#)
MMR (mismatch repair), [369](#), [370f](#), [370t](#)
MOAT (multispecific organic anion transporter), [312](#)
modeling, of protein structures, [40–41](#)
molecular biology, protein and peptide sequencing in, [28](#)
molecular chaperones. *See* chaperones
molecular diagnostic tests, [4](#)
molecular docking programs, protein structures solved by, [40–41](#)

molecular dynamics, protein structures solved by, [40](#)
molecular genetics. *See* recombinant DNA technology
molecular modeling, of protein structures, [40–41](#)
molecular pathology, [590](#)
molecular repair mechanisms, wear and tear theory of aging
 aggregated proteins, [715](#)
 enzymatic and chemical mechanisms, [713](#)
 proofreading and repair mechanisms, [713–714](#)
 protein damage, [714–715](#), [715f](#)
molecular replacement, [40](#)
molecular switches, [586](#)
molybdenum
 absorption of, [101](#)
 human requirement for, [93](#), [93t](#)
 multivalent states of, [93](#), [94f](#), [94t](#)
 physiologic roles of, [100](#), [100f](#)
 toxicity of, [95t](#)
molybdopterin, [95](#), [96f](#), [100](#)
monoacylglycerol acyltransferase, [230](#), [231f](#)
monoacylglycerol pathway, [230](#), [231f](#), [521](#)
2-monoacylglycerols, [231f](#)
monoamine oxidase, [300](#), [301f](#)
monoclonal antibodies (mAbs), [642–643](#), [697–698](#), [702](#), [702t](#)
monocytes, [656](#), [657](#)
moniodotyrosine (MIT), [492](#), [493f](#)
monomeric proteins, [38](#)
mononucleotides, [320](#)
 “salvage” reactions and, [330](#), [331f](#)
monooxygenases
 cytochromes P450 as, [115–116](#), [115f](#), [116f](#)
 xenobiotic hydroxylation by, [556–558](#)
monosaccharides, [141–142](#), [142t](#)
 absorption of, [520](#), [520f](#)
 amino sugars, [145](#), [145f](#)
 deoxy sugars, [145](#), [145f](#)
 glucose as most important, [142](#)
 in glycoproteins, [547](#), [548t](#)

glycosides formed from, 145
isomerism of, 142–143, 143f, 144f
of physiological importance, 143, 144t, 145f
monoubiquitylation, of histones, 351, 353t
monounsaturated fatty acids, 197, 197t
 dietary, cholesterol levels affected by, 257
 synthesis of, 223, 223f
Morquio syndrome, 604t
mortality and aging, 708
mRNA. *See* messenger RNA
mRNA-encoding gene, 441
mRNP exporter, 578
mRNPs (ribonucleoprotein particles), 405, 405f, 430
MS. *See* mass spectrometry
MS². *See* tandem MS
MS–MS. *See* tandem MS
MstII, 433t
 in sickle cell disease, 443, 444f
MSUD (maple syrup urine disease), 290, 293, 293t
MTP (microsomal triacylglycerol transfer protein), 242
mucins, 549
mucopolipidosis, 603
mucopolysaccharidoses, 592, 603–604, 604t
mucoproteins. *See* glycoproteins
mucus, 549
multidimensional protein identification technology (MudPIT), 31
multidrug resistance (MDR), 478
multidrug-resistance-1 protein (MDR-1 protein), 472
multiple inositol polyphosphate phosphatase (MIPP), 53
multiple sclerosis, 234, 473
multiple sulfatase deficiency, 235
multiplexins, 594
multipotent stem cells, 646
multisite phosphorylation, 170
multispecific organic anion transporter (MOAT), 312
muscle
 actin and myosin in, 613–615, 614f, 615f

- amino acid levels and, 271–272, 271*f*, 272*f*
- cardiac, 619–620, 619*t*, 620*f*
- in fasting state, 130, 138–139, 138*t*, 139*f*, 139*t*
- in fed state, 130, 136–138, 137*f*, 138*t*
- genetic disorders of, 621–623, 622*t*, 623*f*, 624*f*
- glucose uptake by, 136–137, 137*f*
- glycogen in, 164, 165*t*
- glycogen phosphorylase regulation in, 167–168, 169*f*
- glycogen synthase regulation in, 170*f*
- glycogenesis in, 164–166, 165*f*, 166*f*
- lactate production by, 160
- ribose synthesis in, 185
- structure of, 612–613, 612*f*, 613*f*
- types of, 612

muscle contraction

- ATP in, 614–616, 615*f*, 620–621, 621*f*
- calcium role in, 611, 616–619, 617*f*, 617*t*, 618*f*
- energy conversion in, 615–616, 615*f*, 616*f*
- glycogen phosphorylase activation with, 168
- nitric oxide in, 622–623, 624*f*
- relaxation phase of, 616
- thin and thick filaments in, 612–613, 613*f*

muscular dystrophy, 445, 622

- glycoprotein synthesis defects in, 554

mutations, genetic, 350–351

- Alu family and, 358, 360
- base substitution, 396–397, 396*f*, 397*f*, 398*f*
- cancer-causing, 683, 701, 703
- constitutive, 411
- frameshift, 398–399, 398*f*
- free radical damage causing, 542
- gene conversion and, 361
- indels and, 359
- integration and, 359–360, 360*f*
- of membrane proteins, diseases caused by, 478, 478*t*
- missense, 396–397, 397*f*, 398*f*, 622
- nonsense, 397–398, 398*f*

point, 396–397, 396*f*, 397*f*, 398*f*, 442, 443*f*
premature termination, 397, 398*f*
recombination and, 359, 359*f*, 360*f*
silent, 396
sister chromatid exchanges and, 361, 361*f*
suppressor, 398–399
transition, 396, 396*f*
transposition and, 360
transversion, 396, 396*f*
xenobiotic role in, 559, 559*f*
Zellweger syndrome and, 579–580
mutator phenotype, 691–692, 692*f*
MYC gene, in cancer, 685, 686*f*, 687*t*
mycophenolic acid, 329*f*, 330
myelin
 galactosylceramide in, 234
 sulfatide in, 202
myelin sheath, 200
myelin sheets, 473
myelinated nerves, depolarization waves along, 196
myelodysplasia, 649
myeloid progenitor cells, 657
myeloperoxidase, 660–661, 660*t*
 iron in, 97–98
myocardial infarction (MI)
 biomarkers of, 567
 serum enzyme analysis after, 64, 65*f*
myofibrils, 612, 612*f*
myoglobin
 α helices in, 48, 48*f*
 biomedical implications of, 54
 biomedical importance of, 47–48
 heme in, 48–49, 48*f*, 49*f*
 hindered environment of, 49, 49*f*
 iron in, 95–96
 oxygen dissociation curve of, 49–50, 49*f*
 secondary and tertiary structures of, 50

myoglobinuria, [54](#)
myokinase. *See* adenylyl kinase
myopathy, lactic acidosis with, [118](#)
myosin, [611](#)
 in muscle contraction, [613–615](#), [614f](#), [615f](#)
 smooth muscle contraction regulation by, [616–618](#), [617f](#), [617t](#)
 structure and function of, [613–614](#), [614f](#), [615f](#)
myosin (thick) filaments, [612–613](#), [613f](#)
myotonia congenita, [620t](#)
myristic acid, [197t](#)
myristoylation, [463](#)
 mass spectrometry detection of, [28t](#)

N

n. *See* Hill coefficient
 Na^+ . *See* sodium
 NAD^+ . *See* nicotinamide adenine dinucleotide
NADH
 fatty acid oxidation production of, [209](#), [209f](#)
 in fatty liver, [244](#)
NADH dehydrogenase, [114](#)
NADH-Q oxidoreductase (Complex I), [118](#), [119f](#), [120](#), [120f](#)
 deficiency of, [126](#)
NAD-linked dehydrogenases, [113](#)
 NADP^+ . *See* nicotinamide adenine dinucleotide phosphate
NADP malate dehydrogenase, [218](#), [219f](#), [220f](#)
NADPH, for lipogenesis, [218](#), [219f](#), [220f](#)
NADPH oxidase, [660](#), [660t](#), [661](#)
NADPH-cytochrome P450 reductase, [557](#)
NADP-linked dehydrogenases, [113](#)
NAFLD (nonalcoholic fatty liver disease), [243](#)
NAGS. *See* N-acetylglutamate synthetase
 Na^+ - K^+ -ATPase, [472–474](#), [472f](#), [473f](#)
nanotechnology, [4](#), [62](#), [62f](#)
NASH (nonalcoholic steatohepatitis), [243](#)
native conformation, protein, [41](#)

Natowicz syndrome, [604t](#)
natural killer cells, [656](#), [662](#)
ncRNAs. *See* noncoding RNAs
NDP (nucleoside diphosphate) kinases, [110](#)
necrosis, [693–694](#)
negative allosteric effectors, [85](#)
negative nitrogen balance, [525](#)
negative predictive value, [562–563](#), [563t](#)
negative regulators, of gene expression, [410](#), [410t](#), [412](#), [414](#), [416](#)
negative supercoils, DNA, [341](#)
neonatal adrenoleukodystrophy, [580](#), [580t](#)
neonatal alloimmune thrombocytopenia, [655](#)
neonates
 hypoglycemia in, [180](#)
 inborn errors of metabolism screening in, [565–566](#)
 jaundice in, [314](#)
 metabolic disease screening in, [278](#)
 tyrosinemia in, [286](#), [287f](#)
neoplasms, [681–682](#), [682f](#)
nephrogenic diabetes insipidus, [472](#)
NER (nucleotide excision-repair), [369](#), [370f](#), [370t](#)
nerve impulses, [473](#)
NESs (nuclear export signals), [578](#)
net diffusion, [468](#)
NET-Seq, [447](#)
NeuAc (*N*-acetylneuraminic acid), [547](#), [548t](#)
neural tube defects, folic acid supplements for, [538](#)
neuraminic acid, [147](#), [202](#)
neuraminidase, influenza, [555](#)
neurodegenerative diseases, prion, [42](#)
neurofilaments, [625](#), [625t](#)
neurolathyrisism, [18](#), [18t](#)
neurologic impairment, profound, [580](#)
neurons, membranes of
 impulses transmitted along, [473](#)
 ion channels in, [470f](#)
neuropathy, vitamin B₆ causing, [535](#)

neurotransmitters, amino acids as, 18
neutral lipids, 196
neutrophil extracellular traps, 661, 661*f*
neutrophils, 656, 657
 enzymes and proteins of, 659, 660*t*
 integrins in, 658–659, 659*t*
 myeloperoxidase in, 661
 in parasite entrapment, 661, 661*f*
newborns, hemoglobins of, 51, 51*f*
next-generation sequencing (NGS), 445–447, 701
NκB (nuclear factor kappa-B), 553, 631
NF-κB pathway, 510–511, 510*f*
NGS (next-generation sequencing), 445–447, 701
NHEJ (nonhomologous end-joining), 369, 370*f*, 370*t*
niacin, 528
 citric acid cycle need for, 153
 deficiency of, 528*t*, 534–535
 functions of, 528*t*, 534
 nicotinamide coenzymes formed from, 113
 toxicity of, 535
nick translation, 434*t*
nickel
 human requirement for, 93, 93*t*
 multivalent states of, 93, 94*f*, 94*t*
 physiologic roles of, 100
 toxicity of, 95*t*
 in urease, 97, 97*f*
nicks and nick-sealing, in DNA replication, 367, 367*f*
nicotinamide, 58, 58*f*, 534
nicotinamide adenine dinucleotide (NAD⁺)
 in citric acid cycle, 152*f*, 153, 155–156
 as coenzyme, 324*t*
 cytochrome P450 use of, 115, 115*f*
 dehydrogenase use of, 113, 113*f*
 in fatty liver, 244
 metabolic compartmentation using, 84
 niacin in synthesis of, 534

spectrophotometric assays using, 63, 63f
substrate shuttles in oxidation of, 125–126, 125f

nicotinamide adenine dinucleotide phosphate (NADP⁺)
as coenzyme, 324t
cytochrome P450 use of, 115, 115f
dehydrogenase use of, 113, 113f
intramitochondrial source of, 125
metabolic compartmentation using, 84
niacin in synthesis of, 534
pentose phosphate pathway formation of, 182–185, 183f, 184f
spectrophotometric assays using, 63, 63f

nicotine, cytochrome P450 metabolism of, 557–558

nicotinic acid, 534
as hypolipidemic drug, 257

Niemann-Pick C-like 1 protein, 257

Niemann-Pick disease, 235t

nitric oxide (NO), 611, 622–623, 624f
arginine conversion to, 297, 297f
in hemostasis and thrombosis, 672

nitric oxide synthases, 297, 297f, 622

nitrite, 623

nitrogen, metabolism of
amino acid oxidases in, 273–274, 274f
ammonia from, 269, 272–275, 274f
disorders of, 276–278, 277t
excreted forms of, 272, 275, 275f
glutamate dehydrogenase in, 273, 274f
glutaminase and asparaginase in, 274, 274f
glutamine synthetase in, 274, 274f
transamination reactions in, 272–273, 273f, 281
urea biosynthesis in, 272–273, 272f, 273f, 275–276, 275f

nitrogen balance, 269, 525–526

nitrogenase, 97

nitroglycerin, 611

p-nitrophenyl phosphate (*p*NPP), 63

NLS (nuclear localization signal), 574t, 577–578, 578f

NMP (nucleoside monophosphate) kinases, 110

NMR (nuclear magnetic resonance) spectroscopy, protein structures solved by, [40](#)

NO. *See* nitric oxide

nodes of Ranvier, [473](#)

nodularin, [14](#)

nonalcoholic fatty liver disease (NAFLD), [243](#)

nonalcoholic steatohepatitis (NASH), [243](#)

non-clathrin-coated vesicles. *See* transport vesicles

noncoding RNAs (ncRNAs), [347–348](#). *See also* long noncoding RNAs; micro-RNAs; ribosomal RNA; silencing RNAs; small nuclear RNA; transfer RNA

 in cancer, [689–690](#)

 gene expression modulation by, [428–429](#)

noncoding strand, [339](#), [344f](#)

noncompetitive inhibitors, [77–78](#), [77f](#), [78f](#)

noncovalent assemblies, in membranes, [461](#)

noncovalent forces

 biomolecule stabilization by, [7–8](#), [8f](#)

 peptide conformations and, [21](#)

 in protein tertiary and quaternary structures, [39](#)

nonequilibrium reactions

 in glycolysis regulation, [160–161](#)

 regulation of metabolic pathways with, [135](#)

nonessential amino acids, [131](#), [264](#), [264t](#), [526](#)

nonesterified fatty acids. *See* free fatty acids

nonheme iron proteins. *See* iron-sulfur proteins

nonhistone proteins, [351](#)

nonhomologous end-joining (NHEJ), [369](#), [370f](#), [370t](#)

nonketotic hyperglycinemia, [283](#)

non-lipid-soluble molecules, [462–463](#)

nonoverlapping of genetic code, [395](#)

nonpolar groups, noncovalent interactions of, [8](#)

nonpolar lipid core, of lipoprotein, [237–238](#), [238f](#)

nonrepetitive (unique-sequence) DNA, [357](#)

nonsense codons, [394](#), [397–398](#), [398f](#)

nonsense mutations, [397–398](#), [398f](#)

nonsteroidal anti-inflammatory drugs

cyclooxygenase affected by, 226
prostaglandins synthesis and, 216, 226
nontemplate strand DNA, 375
non- α -peptide bonds, between ubiquitin and proteins, 270, 270f
norepinephrine. *See also* catecholamines
glycogen regulation by, 167–168
synthesis of, 484f, 491, 491f
in thermogenesis, 247, 247f
tyrosine conversion to, 300, 302f
Northern (RNA-DNA) blotting, 341
Northern RNA blot procedure, 438, 439f
NPCs (nuclear pore complexes), 577
pNPP (*p*-nitrophenyl phosphate), 63
N-terminal binding domain, 37
nuclear export signals (NESs), 578
nuclear factor kappa-B (NF κ B), 553, 631
nuclear genes, proteins encoded by, 576
nuclear localization signal (NLS), 574t, 577–578, 578f
nuclear magnetic resonance (NMR) spectroscopy, protein structures solved by, 40
nuclear pore complexes (NPCs), 577
nuclear receptor coregulators, 513–514, 513f, 514t
nuclear receptor superfamily, 511–513, 512f, 513t
nuclear receptors, 482
nucleases, 9
active chromatin and, 354
nucleic acid digestion by, 348
nucleic acids
biomedical importance of, 338
nuclease digestion of, 348
nucleolytic processing, of RNA, 390–391, 390f
nucleophiles
definition of, 8
in enzymatic catalysis, 58
water as, 8–10
nucleophilic attack, 364, 365f
nucleoproteins, packing of, 355, 355t, 356f

- nucleoside diphosphate (NDP) kinases, [110](#)
- nucleoside diphosphates, chemistry of, [320](#), [321f](#)
- nucleoside monophosphate (NMP) kinases, [110](#)
- nucleoside triphosphates
 - chemistry of, [320](#), [321f](#)
 - group transfer potential of, [324](#)
 - nonhydrolyzable analogs of, [325](#), [325f](#)
- nucleosides, [321–323](#), [322t](#)
 - biomedical importance of, [320](#)
 - chemistry of, [320](#), [321f](#)
 - triphosphates, [324](#)
- nucleosomes, [351](#), [351f](#), [352f](#), [353](#)
 - transcription machinery and, [384](#)
- nucleotide adducts, carcinogens forming, [684](#)
- nucleotide excision-repair (NER), [369](#), [370f](#), [370t](#)
- nucleotides, [322t](#)
 - biomedical importance of, [320](#)
 - biosynthesis of, purines, [328](#), [328f](#)
 - chemistry of, [320](#), [321f](#)
 - dietarily nonessential, [328](#)
 - frameshift mutations of, [397–398](#), [398f](#)
 - metabolism of, biomedical importance of, [327–328](#)
 - mutations caused by changes in, [396–398](#), [396f](#), [397f](#), [398f](#)
 - physiologic functions of, [321–323](#), [323f](#), [324t](#)
 - as polyfunctional acids, [321](#)
 - polynucleotides, [325](#)
 - substitution mutations of, [396–397](#), [396f](#), [397f](#), [398f](#)
 - synthetic analogs of, in chemotherapy, [324–325](#), [324f](#), [325f](#)
 - triplet codes of, [394](#), [394t](#)
 - ultraviolet light absorption by, [321](#)
- nucleus of cell
 - macromolecule transport in, [575f](#), [576–579](#), [577t](#), [578f](#)
 - protein sorting signals in, [573](#), [574t](#)
- nutrigenomics, [3](#)
- nutrition
 - antioxidants and. *See* antioxidants
 - biochemical research impacts on, [2–3](#)

- biomedical importance of, 519
- lipogenesis regulated by, 220
- requirements
 - energy, 129–130, 524–525, 524*f*
 - protein and amino acid, 525–526
 - transition metals, 93, 93*t*
 - vitamins and minerals, 527–528
- nutritional disorders
 - amino acid deficiency, 14, 131, 264, 264*t*, 526
 - collagen defects in, 43
 - multiple deficiency states in, 527
- nutritionally essential fatty acids, 222, 222*f*
 - abnormal metabolism of, 226
 - deficiency of, 224, 225

O

- O gene, 653–654
- obesity, 105, 130, 237, 519, 524
 - cancer development and, 700
 - lipids and, 196
 - lipogenesis and, 216
- obstructive jaundice, 242
- octamers, histone, 351, 351*f*, 352*f*, 353
- oculocerebrorenal syndrome, 585*t*
- β -ODAP (β -*N*-oxalyl-L- α , β -diaminopropionic acid), 18, 18*t*
- oils, 196
- Okazaki fragments, 363–364, 363*t*, 366*f*
- oleic acid, 196, 196*f*, 197*t*, 198*f*
 - nutritionally essential, 222, 222*f*
 - synthesis of, 223–224, 223*f*
- oleoyl-CoA, 223, 223*f*
- oligomers, import of by peroxisomes, 579
- oligomycin, 123
- oligonucleotide, synthesis of, 439
- oligosaccharide processing, 574
- oligosaccharide:protein transferase, 581
- oligosaccharides, 142, 546, 547*t*, 550–551, 550*f*, 555

ω 3 fatty acids
 long-chain, 196, 199
 synthesis of, 223–224, 223f
 VLDL secretion and, 243

ω 6 fatty acids, 196, 199
 synthesis of, 223–224, 223f

ω 9 fatty acids, 196
 synthesis of, 223–224, 223f

OMP (orotidine monophosphate), 333f

oncogenes, 685–688, 685t, 686f, 687f, 687t, 688f, 688t
 cyclins and, 369
 early studies on, 2

oncology, 681, 701

oncoproteins, Rb protein and, 369

oncotic (osmotic) pressure, 628, 630

oncoviruses, cyclins and, 369

open complex, 376f, 379

operator locus, 411f, 412

operon, 411–412, 411f, 413f, 414

operon model, 411–412, 411f, 413f, 414

opsonization, 659

optical activity, 142

optical isomers, of monosaccharides, 142–143

oral rehydration therapy, 474

ORC (origin replication complex), 362

ORE (origin replication element), 362

organ function tests, 566–567

organometallic complexes, transition metals in, 95–97, 95f, 96f, 96t, 97f

organs, metabolic pathways at level of, 132–133, 132f, 133f

origin of replication (ori), 362–363, 362f

origin replication complex (ORC), 362

origin replication element (ORE), 362

ornithine
 arginine conversion to, 297, 297f
 carbon skeleton catabolism of, 282, 283f
 in urea synthesis, 275–276, 275f

ornithine permease, defects in, 277

ornithine transaminase, 282, 283f
ornithine transcarbamoylase
 defects in, 277–278
 deficiency of, 336
 in urea synthesis, 275f, 276
ornithine-citrulline antiporter, defect in, 282
orotate phosphoribosyltransferase, 333f, 334, 336, 336t
orotic acid, 243, 244, 333f
orotic aciduria, 336, 336t
orotidine monophosphate (OMP), 333f
orotidinuria, 336
orotidylate decarboxylase, 336
orotidylic acid decarboxylase, 336t
osmotic (oncotic) pressure, 628, 630
osteoarthritis, 592, 604
osteoblasts, 605, 606f
osteocalcin, 539
osteoclasts, 605, 606f
osteocytes, 605
osteogenesis imperfecta, 43, 264, 607, 607t
osteomalacia, 532
osteopetrosis, 607
osteopontin, 605
osteoporosis, 532, 607, 607t
ouabain, 145, 473
outer membrane, of mitochondria, 118, 118f
outer mitochondrial membrane, 576
outside-in transmembrane signaling, in platelet aggregation, 670, 671f
ovarian steroidogenesis, 487–489, 489f, 490f
overlay blot procedure, 438, 439f
overnutrition, 524–525, 524f. *See also* obesity
oxaloacetate, 134
 asparagine and aspartate formation of, 281–282
 in citric acid cycle, 150–154, 151f, 152f, 154f
 in gluconeogenesis, 172–173, 173f
 in lipogenesis, 218–219, 220f
 β -N-oxalyl-L- α , β -diaminopropionic acid (β -ODAP), 18, 18t

oxidases, [112](#), [112f](#), [113f](#)

oxidation

biomedical importance of, [111](#)

definition of, [111](#)

dehydrogenase reactions, [112–114](#), [113f](#)

endergonic reaction coupling to, [106–107](#), [106f](#), [107f](#)

of fatty acids. *See also* ketogenesis

acetyl-CoA release and, [208–210](#), [208f](#), [209f](#), [210t](#)

clinical aspects of, [214–215](#)

hypoglycemia caused by impairment of, [214–215](#)

ketogenesis regulation and, [213–214](#), [213f](#), [214f](#)

in mitochondria, [207–208](#), [208f](#)

modified, [210](#)

of heme iron, [649–651](#), [650f](#), [650t](#), [651f](#)

hydroperoxidase reactions, [114](#)

of iodide, [492](#)

oxidase reactions, [112](#), [112f](#), [113f](#)

oxygenase reactions, [111–112](#), [114–116](#), [115f](#), [116f](#)

in pentose phosphate pathway, [183–185](#), [183f](#), [184f](#)

phosphorylation coupling to, [122–123](#), [123t](#)

pyruvate. *See* pyruvate oxidation

redox potential and, [111–112](#), [112t](#)

of reducing equivalents by respiratory chain, [118–121](#), [119f](#), [120f](#), [121f](#)

substrate shuttles mediating, [125–126](#), [125f](#)

superoxide dismutase reactions, [116](#)

of transition metals, [93](#), [94f](#), [94t](#)

β -. *See* β -oxidation

oxidative damage. *See* reactive oxygen species

oxidative decarboxylation

of amino acid oxidases, [273–274](#), [274f](#)

in citric acid cycle, [152](#), [152f](#)

of pyruvate, [161–163](#), [162f](#)

oxidative phosphorylation, [620](#)

biomedical importance of, [118](#)

clinical aspects of, [126](#)

control of, [122–123](#), [123t](#)

in energy conservation and capture, [108](#)

high-energy phosphate synthesis by, [118](#), [121–122](#), [122f](#)
inhibition of, [118](#)
in mitochondrial compartments, [118](#), [118f](#)
uncoupling of, [123–124](#)
oxidoreductases, [57](#), [112](#)
 structure of, [37](#), [38f](#)
oxidosqualene:lanosterol cyclase, [250](#), [252f](#)
oxygen
 Complex IV reduction of, [120–121](#)
 heme binding of, [48–49](#), [48f](#), [49f](#)
 hemoglobin affinities for, [51](#), [51f](#)
 hemoglobin binding of, [51–52](#), [51f](#), [52f](#)
 toxicity of, [116](#). *See also* reactive oxygen species
 transport and storage of, [47](#)
 biomedical implications of, [54–55](#)
 heme and ferrous iron roles in, [48–49](#), [48f](#), [49f](#)
 hemoglobin and myoglobin suitability for, [49–50](#), [49f](#)
 hemoglobin conformational changes during, [50–53](#), [50f](#), [51f](#), [52f](#), [53f](#)
 hemoglobin mutations impacting, [53–54](#), [54f](#)
 high altitude changes in, [53](#)
oxygen debt, [160](#)
oxygen dissociation curve
 of hemoglobin, [49–50](#), [49f](#)
 of myoglobin, [49–50](#), [49f](#)
oxygen radicals. *See* reactive oxygen species
oxygen tension, in cancer cells, [696](#)
oxygenases, [111–112](#), [114–116](#), [115f](#), [116f](#)
oxysterols, [204](#)

P

P bodies, [405](#), [405f](#), [429](#)
P component, in amyloidosis, [639](#)
P (peptidyl) site, of 80S ribosome, [402](#), [403f](#)
P₅₀, [51](#), [51f](#)
P53 gene, [687t](#), [691](#), [694](#)
p53 protein, [372](#)
p70S6K, [508](#), [509f](#)

p97, [584](#)
p160 family of coactivators, [514](#), [514t](#)
P450scc (cytochrome P450 side chain cleavage enzyme), [485](#), [485f](#)
PAB (poly(A) binding protein), [401](#), [401f](#), [402f](#)
PAC (*E. coli* bacteriophage P1-based) vector, [437](#), [437t](#)
paclitaxel, [625](#)
paddle, charged, [471](#), [471f](#)
PAF. *See* platelet-activating factor
PAGE (polyacrylamide gel electrophoresis), [26](#), [26f](#)
pain, prostaglandins in, [216](#)
PAL (physical activity level), [524](#)
palmitate, [217–218](#), [219f](#), [220f](#)
palmitic acid, [196f](#), [197t](#)
palmitoleic acid, [197t](#), [222](#), [222f](#)
palmitoleoyl-CoA, [223](#)
palmitoylation, mass spectrometry detection of, [28t](#)
palmitoyl-CoA, [223](#)
pancreatic cancer, hyperbilirubinemia caused by, [313f](#), [313t](#), [314](#)
pancreatic insufficiency, vitamin B₁₂ deficiency in, [536](#)
pancreatic lipase, [521](#)
pancreatitis, protease activation in, [87](#)
panproteainase, [638](#)
pantothenic acid, [217](#)
 citric acid cycle need for, [153](#)
 coenzymes derived from, [58](#), [539](#)
 deficiency of, [528t](#)
 functions of, [528t](#), [539](#), [539f](#)
PAP (phosphatidate phosphatase), [230](#), [231f](#)
PAPS (3'-phosphoadenosine-5'-phosphosulfate), [322–323](#), [323f](#), [324t](#), [558](#),
 [600](#)
PAR (physical activity ratio), [524](#)
PAR-1. *See* protease-activated receptor-1
PAR-4. *See* protease-activated receptor-4
paracrine signaling, [662](#)
parallel β sheet, [36](#), [36f](#)
paramecia, [660](#)
parasites, glycans in binding of, [555](#)

parathyroid hormone (PTH)
 storage of, [497](#), [497t](#)
 synthesis of, [494](#), [495f](#)

paroxysmal nocturnal hemoglobinuria, [478t](#), [554](#), [650t](#), [651](#)

PARP (poly ADP ribose polymerase), [371](#), [371f](#)

partial proteolysis. *See* selective proteolysis

passenger mutations, [701](#)

passive diffusion, [467–468](#), [467f](#), [467t](#), [468f](#), [469f](#)

pBR322, [437](#), [437f](#)

P-cluster, [97](#)

PCR. *See* polymerase chain reaction

PCSK9 (proprotein convertase subtilisin/kexin type 9), [253](#)

PDGF (platelet-derived growth factor), in cancer, [689](#), [689t](#)

PDH. *See* pyruvate dehydrogenase

PDI (protein disulfide isomerase), [584](#)

PDK1 (phosphoinositide-dependent kinase 1), [508](#), [509f](#)

pectin, [147](#), [148f](#)

pedigree analysis for sickle cell disease, [443–444](#), [444f](#)

pellagra, [534–535](#)

penicillamine, for Wilson disease, [634](#)

penicillin, [80](#)

pentose phosphate pathway, [130](#), [131f](#)
 biomedical importance of, [182](#)
 cellular location of, [182–183](#)
 glycolysis connections with, [183f](#), [185](#)
 hemolysis protection from, [185–186](#), [186f](#)
 impairment of, [188–189](#)
 irreversible oxidative phase of, [183–185](#), [183f](#), [184f](#)
 NADPH produced by, for lipogenesis, [218](#), [219f](#), [220f](#)
 reducing equivalents generated by, [185](#)
 reversible nonoxidative phase of, [183](#), [183f](#), [184f](#), [185](#)

pentoses, [141](#), [142t](#), [143](#), [144t](#)

pentosuria, [182](#), [189](#)

pepsin, [521](#)

pepsinogen, [521](#)

peptic ulcers, [555](#)

peptidases, proteins degradation by, [270–271](#), [270f](#), [271f](#)

peptide bonds
 between amino acids, 20
 formation of, 9, 402
 hydrolysis of, 708–709, 709*f*
 partial double-bond character of, 21, 22*f*
 secondary structure restrictions from, 34–35, 34*f*
 between ubiquitin and proteins, 270, 270*f*

peptide hormone receptors, 482

peptide hormones, glycoproteins as, 546

peptides
 absorption of, 521, 523
 l- α -amino acids in, 15, 15*t*–16*t*
 biomedical importance of, 14
 conformations of, noncovalent forces affecting, 21
 as hormone precursors, 484, 484*f*
 as polyelectrolytes, 21–22
 as precursors in hormone synthesis, 492–493
 purification of
 chromatographic techniques, 23–26, 26*f*, 27*f*
 gel electrophoresis, 26, 26*f*, 27*f*
 isoelectric focusing, 26, 27*f*
 sequencing of. *See* protein sequencing
 structure drawings for, 21
 structure of, primary. *See* primary structure
 unusual amino acids in, 21, 21*f*
 volatilization of, 29–30, 30*f*

peptidyl prolyl isomerase (PPI), 584

peptidyl (P) site, of 80S ribosome, 402, 403*f*

peptidyl transferase, 402, 403*t*

peptidylarginine deiminase, 661, 661*f*

peptidylglycine hydroxylase, vitamin C as coenzyme for, 539

peptidyl-tRNA, 402–403, 403*f*, 403*t*

perilipin, 247

periodic table, 94*f*

peripheral proteins, 464–465, 464*f*

permeability coefficients, of substances in lipid bilayer, 462, 463*f*

pernicious anemia, 536–537

peroxidases, 114, 224, 544
peroxidation, of lipids, 203–204, 204*f*, 710, 711*f*
peroxides
 lipid, 541–542, 542*f*
 mechanisms protecting against, 544, 544*f*
 reduction of, 114
peroxins, 579–580
peroxisomal–matrix targeting sequences (PTSs), 574*t*, 579, 579*f*
peroxisomes, 114
 biogenesis of, 579–580
 disorders due to abnormalities of, 580*t*, 589–590
 in fatty acid oxidation, 210
 in polyunsaturated fatty acid synthesis, 223*f*
 protein sorting signals in, 573, 574*t*
 proteins imported into, 579, 579*f*
 in transcription regulation, 513*t*
 in Zellweger syndrome, 215, 579–580, 580*t*
peroxynitrite, 623
personalized medicine, 432
pertussis toxin, 504
PGE₂ (prostaglandin E₂), 197, 198*f*
PGI₂ (prostacyclin), 670, 671*f*, 672
PGI₂ (prostaglandin I₂), 224
PGIs. *See* prostacyclins
PGs. *See* prostaglandins
pH
 amino acid properties and, 19, 19*f*
 biomedical importance of, 6
 buffering and, 12–13, 12*f*
 in cancer cells, 696
 definition and calculation of, 10–11
 isoelectric, 19
 p*K*_a relationship to, 11–12
 reaction rate response to, 72–73, 73*f*
 of water, 10
pH gradient, 576

phages, in recombinant DNA technology, 436, 437t
phagocytic cells, 660
phagocytosis, 474, 656, 657, 659–661, 659f, 660t
phagosomes, 659
pharmacogenomics, 3
phasing, of nucleosome, 353
phenobarbital, 557
phenols, sulfation of, 558
phenyl isothiocyanate, 27, 27f
phenylalanine, 16t
 carbon skeleton catabolism of, 286, 288f
 ultraviolet light absorption by, 20, 20f
phenylalanine hydroxylase, 266, 267f, 286, 288f
 gene location of, 442t
phenylethanolamine-*N*-methyltransferase (PNMT), 491f, 492
phenylketonuria (PKU), 286, 288f
phi angle, 34, 34f
phosphagens, in energy conservation and capture, 108
phosphatase cascade, 482, 483t
phosphatases, in recombinant DNA technology, 434t
phosphate transporter, of mitochondria, 124, 124f
phosphates
 creatine phosphate shuttle for, 126, 126f
 energy capture and transfer by, 107–108, 107t, 108f, 121–122
 in extracellular and intracellular fluid, 460t
 oxidative phosphorylation in synthesis of, 118, 121–122, 122f
 in RNA synthesis, 378
phosphatidate, 230–232, 230f, 231f, 232f
phosphatidate phosphatase (PAP), 230, 231f
phosphatidate phosphohydrolase, 230, 231f
phosphatidic acid, 199, 200f, 461, 461f
phosphatidylcholines, 200, 200f
 membrane asymmetry and, 464
 metabolism of, 233f
 synthesis of, 230, 230f, 231f
phosphatidylethanolamine (cephalin), 200, 200f
 membrane asymmetry and, 464

synthesis of, [230](#), [230f](#), [231f](#)
phosphatidylglycerol, [200f](#), [201](#)
phosphatidylinositides
calcium-dependent hormone action and, [507–508](#), [507f](#), [508f](#)
as second messenger, [200](#), [200f](#), [482](#), [483t](#), [502](#)
phosphatidylinositol 4,5-bisphosphate (PIP₂), [200](#)
in absorptive pinocytosis, [475](#)
phospholipase C cleavage of, [507](#), [508f](#)
in platelet aggregation, [670](#), [671f](#)
phosphatidylinositols
in membranes, [200](#), [200f](#)
synthesis of, [230](#), [230f](#), [231f](#)
phosphatidylserine, [200](#), [200f](#), [230](#), [230f](#), [231f](#)
membrane asymmetry and, [464](#)
3'-phosphoadenosine-5'-phosphosulfate (PAPS), [322–323](#), [323f](#), [324t](#), [558](#),
[600](#)
phosphodiesterases, [167](#), [168f](#), [169f](#), [325](#), [505](#)
phosphoenolpyruvate
in gluconeogenesis, [172–173](#), [173f](#)
in glycolysis, [159](#), [159f](#)
phosphoenolpyruvate carboxykinase, [153](#)
in gluconeogenesis, [173](#), [173f](#)
phosphofructokinase
deficiency of, [163](#)
in glycolysis, [159](#), [159f](#)
regulation of, [161](#), [176](#), [176f](#)
reversal of reaction catalyzed by, [173f](#), [174](#)
phosphofructokinase-2, [176](#), [177f](#)
phosphoglucomutase, in glycogenesis, [164](#), [165f](#)
6-phosphogluconate dehydrogenase, [183f](#), [184](#), [184f](#)
6-phosphogluconolactone, [183–184](#), [183f](#), [184f](#)
2-phosphoglycerate, in glycolysis, [159](#), [159f](#)
3-phosphoglycerate, in glycolysis, [159](#), [159f](#)
3-phosphoglycerate dehydrogenase, allosteric regulation of, [85](#)
phosphoglycerate kinase
in erythrocytes, [161](#)
in glycolysis, [159](#), [159f](#)

phosphoglycerate mutase, in glycolysis, 159, 159f
phosphoglycerides, in membranes, 461, 461f, 589
phosphoglycerols
 degradation and remodeling of, 232–233, 233f
 lysophospholipids in metabolism of, 201, 201f
 synthesis of, 230–232, 230f
phosphohexose isomerase, in glycolysis, 159, 159f
phosphoinositide-dependent kinase 1 (PDK1), 508, 509f
phosphoinositides, 200, 482, 483t
phospholipase A₁, 232, 233f
phospholipase A₂, 232, 232f, 233f
phospholipase B, 232, 233f
phospholipase C (PLC), 658
 activation and hormone-receptor interactions of, 507, 507f
 in phosphoglycerol degradation and remodeling, 232, 233f
 PiP₂ cleavage by, 507, 508f
phospholipase Cβ (PLCβ), in platelet aggregation, 670, 671f
phospholipase D, 232, 233f
phospholipases, in phosphoglycerol degradation and remodeling, 232–233, 233f
phospholipid bilayer, noncovalent interactions in, 8
phospholipid exchange proteins, 464
phospholipids, 196
 clinical aspects of, 234–235
 digestion and absorption of, 520–521, 522f
 glycerol ether, synthesis of, 230, 232, 232f
 in lipoprotein lipase activity, 240
 in lipoproteins, 236, 237
 in membranes, 199–201, 200f, 461, 461f, 463, 589
 asymmetry of, 464, 589, 589f
 in multiple sclerosis, 234
 as second messenger precursors, 229
 synthesis of, 230, 231f
phosphomevalonate kinase, 251f
phosphoprotein phosphatases, 505–506
phosphoproteins, 505

phosphoribosyl pyrophosphate (PRPP)
in Lesch-Nyhan syndrome, 334–335
in purine synthesis, 328, 329*f*, 330
in pyrimidine synthesis, 332, 332*f*, 333*f*

phosphoric acid, pK_a of, 13*t*

phosphorolysis, as group transfer reaction, 9

phosphorylase kinase a, 168, 169*f*, 171*f*

phosphorylase kinase b, 89*t*, 168, 169*f*, 171*f*

phosphorylation
in energy conservation and capture, 108
enzyme regulation by, 86–90, 88*f*, 89*t*
in glycogen regulation, 166–168, 169*f*, 170, 171*f*
in glycolysis and gluconeogenesis regulation, 175
of histones, 351, 353*t*
mass spectrometry detection of, 28*t*
multisite, 170
oxidation coupling to, 122–123, 123*t*
oxidative. *See* oxidative phosphorylation
of pyruvate dehydrogenase, 161–163, 162*f*
respiratory chain level, 122
in RNA polymerase II activation, 384, 385*f*
substrate level, 122

phosphoserine, 300

phosphothreonine, 300

phosphotriose isomerase, in glycolysis, 159, 159*f*

phosphotyrosine, 300

photolysis, 489–490

photosensitivity, porphyrias causing, 311

phyloquinone, 528*t*, 532–533, 533*f*

physical activity
energy requirements for, 524
oxygen debt after, 160

physical activity level (PAL), 524

physical activity ratio (PAR), 524

physiologic jaundice, 314

phytanic acid, Refsum disease caused by accumulation of, 215

phytase, 523

phytic acid, [523](#)

phytohemagglutinins, [547](#)

pI. *See* isoelectric pH

PIC. *See* preinitiation complex

ping-pong mechanism, in facilitated diffusion, [469](#), [469f](#)

ping-pong reactions, [79](#), [79f](#), [80f](#)

- in covalent catalysis, [59](#), [59f](#)
- transamination, [59](#), [59f](#), [273](#), [273f](#)

pinocytosis, [474–475](#), [474f](#)

PiP₂. *See* phosphatidylinositol 4,5-bisphosphate

pituitary gland, hormones of, [179](#)

PK. *See* pyruvate kinase

pK_a

- of amino acids, [19–20](#), [20t](#)
- of l- α -amino acids, [15t–16t](#)
- environmental influence on, [19–20](#), [20t](#)
- medium properties affecting, [13](#)
- molecular structure effects on, [13](#), [13t](#)
- of weak acids, [11–13](#), [12f](#), [13t](#), [19](#)

PKA (protein kinase A), [504–505](#), [505f](#)

PKC. *See* protein kinase C

PKU (phenylketonuria), [286](#), [288f](#)

plants, toxic amino acids of, [18](#), [18t](#)

plasma, [628](#)

- analysis of enzymes in, [63–64](#), [64t](#), [65f](#)

plasma glucose concentration. *See* blood glucose

plasma membrane, [459](#). *See also* membranes

- asymmetry of, [589](#), [589f](#)
- cholesterol in, [461](#)
- glycoproteins anchored to, [552](#)
- glycosphingolipids in, [461](#)
- mutations in, diseases caused by, [478](#), [478t](#)
- specialized structures of, [466](#), [466f](#)

plasma proteins, [133](#)

- deposition of, [639](#), [639t](#)
- electrophoresis for analysis of, [628](#)

fluid distribution and, 628
functions of, 630t
glycoproteins as, 546
half-life of, 630
haptoglobin, 631–632, 631f
immunoglobulins, 639–643, 640t, 641f, 642f, 643f
in inflammation, 630–631, 630t
polymorphism of, 629
synthesis of, 133, 628–629
plasma samples, 563
plasma transport proteins, 498–499, 498t
plasmalogens, 201, 201f
 biosynthesis of, 230f, 232, 232f
plasmids, 436, 436f, 437f
plasmin, 678–679, 678f
plasminogen, 678–679, 678f
plasminogen activators, in hemostasis and thrombosis, 672
Plasmodium falciparum, glycans in binding of, 555
platelet aggregation, 670, 671f
 laboratory tests measuring, 679
platelet count, 679
platelet-activating factor (PAF), 229
 synthesis of, 230f, 232, 232f
platelet-derived growth factor (PDGF), in cancer, 689, 689t
platelets, 646, 654–655, 659t
 inhibitors of activation of, 671f, 672
PLC. *See* phospholipase C
PLC β (phospholipase C β), in platelet aggregation, 670, 671f
pleckstrin, in platelet aggregation, 670, 671f
PLP (pyridoxal phosphate), 273, 273f, 535
pluripotent stem cells, induced, 446, 646
PNMT (phenylethanolamine-*N*-methyltransferase), 491f, 492
pOH, 10
point mutations, 396–397, 396f, 397f, 398f, 442, 443f
poisons, respiratory chain inhibitors, 112, 118, 123–124, 123f, 124f
polar groups
 hydrogen bonding by, 7, 7f

- noncovalent interactions of, 8
- polar head groups, 461–462
- polarity
 - of DNA, 339, 340*f*
 - of DNA synthesis, 364, 366*f*
 - of microtubules, 624
 - of protein synthesis, 399
- poly ADP ribose polymerase (PARP), 371, 371*f*
- poly(A) binding protein (PAB), 401, 401*f*, 402*f*
- poly(A) polymerase, 389
- poly(A) tail of mRNA, 345, 389, 401, 401*f*
- polyacrylamide gel electrophoresis (PAGE), 26, 26*f*
- polyadenylation, alternative, 430
- polyamines, biosynthesis and catabolism of, 299, 299*f*, 300*f*
- polycistronic mRNA, 411
- polycomb repressive complex 2 (PRC2), 419
- polycythemia, hemoglobin mutations leading to, 54
- polyelectrolytes, peptides as, 21–22
- polyhydric alcohols, carbohydrates as aldehyde or ketone derivatives of, 141–142, 142*t*
- polyisoprenoids, in cholesterol synthesis, 250–251, 251*f*
- polymerase chain reaction (PCR), 439–440, 441*f*
 - medical applications of, 65
 - in microsatellite repeat sequence detection, 358
- polymerases
 - DNA. *See* DNA polymerases
 - RNA. *See* RNA polymerase II; RNA polymerases
- polymerization, of hemoglobin S, 54, 54*f*
- polymorphisms, 442
 - microsatellite, 358, 445–446
 - plasma protein, 629
- polymorphonuclear leukocytes, 657
- polynucleotide kinase, 434*t*
- polynucleotides
 - as directional macromolecules, 325
 - as DNA and RNA, 325
 - functions of, 321

- modification of, [321](#), [323f](#)
- posttranslational modification of, [325](#)
- polyol pathway, [190–191](#)
- polyols, [141–142](#)
- polyprenoids, [203](#), [204f](#)
- polyps, colorectal, [687–688](#), [688f](#), [688t](#)
- polyribosomes, [347](#), [401f](#), [405](#)
 - membrane-bound, [580](#)
 - protein synthesis on, [574](#), [574f](#), [575f](#), [576](#), [579](#), [583](#)
 - signal hypothesis of binding of, [574](#), [574f](#)
- polysaccharides, [142](#)
 - storage and structural functions of, [145–147](#), [147f](#), [148f](#), [148t](#)
- polysomes. *See* polyribosomes
- polytene chromosomes, [354](#), [354f](#)
- polyubiquitination, [270](#)
- polyunsaturated fatty acids, [196f](#), [197](#), [197t](#)
 - dietary, cholesterol levels affected by, [257](#)
 - eicosanoids formed from, [224](#), [225f](#)
 - essential, [222](#), [222f](#)
 - synthesis of, [223–224](#), [223f](#)
- POMC peptide family, [496–497](#), [497f](#)
- Pompe disease, [166](#), [167t](#)
- porcine stress syndrome, [618](#)
- porphobilinogen, in heme synthesis, [306](#), [307f](#), [308f](#), [309f](#)
- porphobilinogen synthase, [306](#), [307f](#), [308f](#), [309f](#)
- porphyrias, [305](#), [310](#), [311f](#)
 - classification of, [310t](#), [311](#)
 - drug-induced, [311](#)
 - spectrophotometric assessment of, [308](#)
- porphyrinogens
 - accumulation of, [310–311](#)
 - colorless nature of, [308](#)
 - in heme synthesis, [306–307](#), [307f](#), [308f](#), [309f](#)
- porphyrins
 - biomedical importance of, [305](#)
 - biosynthesis of, [305–307](#), [306f](#), [307f](#), [308f](#), [309f](#), [310t](#)
 - regulation of, [307–308](#)

catabolism of, 311–313, 312*f*, 313*f*
color and fluorescence of, 308, 310*f*
structure of, 305, 306*f*

positive cooperativity, 76

positive nitrogen balance, 525

positive predictive value, of laboratory tests, 562–563, 563*t*

positive regulators, of gene expression, 410, 410*t*, 414, 416

posttranslational modifications
of amino acids, 15, 17, 17*f*
biomedical importance of, 33
of collagen, 594–595, 594*t*
of histones, 351, 353*t*
mass spectrometry detection of, 28, 28*t*
of membrane proteins, 589
polynucleotides, 325
in protein maturation, 42–44, 43*f*

posttranslational processing, 406

posttranslational translocation, 576, 581–582, 582*f*

potassium (K⁺)
in extracellular and intracellular fluid, 460, 460*t*
permeability coefficient of, 463*f*

potassium (K⁺) ion channels, 470–471, 471*f*

power stroke, 615–616, 616*f*

PP_i. *See* inorganic pyrophosphate; pyrophosphate

PPI (peptidyl prolyl isomerase), 584

prasugrel, 672

pravastatin, 257

PRC2 (polycomb repressive complex 2), 419

precision, of laboratory test, 561, 561*f*

precision oncology, 701

predictive value, of laboratory tests, 562–563, 563*t*

pregnancy
fatty liver of, 215
glucose requirement of, 136
hypoglycemia during, 180

pregnenolone, 485*f*, 487, 488*f*, 490*f*

preinitiation complex (PIC), 377, 382f
assembly of, 385–386, 385f
nucleosomes and, 384
in protein synthesis, 399, 400f
43S preinitiation complex, in protein synthesis, 399, 400f
premature termination, 397, 398f
prenatal diagnosis, 444–445, 445f
S-prenylation, 463
cis-prenyltransferase, 251f
trans-prenyltransferase, 251f
preproalbumin, 588, 588f
preprocollagen, 594
preprohormone, 493
preproprotein, 630
preproPTH, 494, 495f
preproteins, 574
presequence, 576
preventive antioxidants, 204
preventive medicine, biochemical research impacts on, 2–3
primaquine, 721
primary hyperoxaluria, 283
primary lysosomes, 474
primary structure
amino acids and, 20–21
of collagen, 43, 43f
determination of
Edman reaction for, 27–28, 27f
genomics and, 28
mass spectrometry for, 28–30, 28t, 29f, 30f
molecular biology techniques for, 28
proteomics and, 30–31
purification techniques for, 23–26, 25f, 26f, 27f
Sanger’s work in, 26–27
as order of protein structure, 34
primary structure, of RNA, 342–343, 346f
primary transcripts, 356, 376, 390–391, 390f
primary transport, 469

primases, DNA, [362f](#), [363t](#)
pri-miRNAs, [390–391](#), [390f](#)
primosome, [363](#)
prion diseases, pathologic protein conformations in, [42](#)
PRL. *See* prolactin
proalbumin, [588](#), [588f](#)
probing techniques, [438](#), [439f](#)
procarcinogens, [556–557](#), [559](#), [559f](#), [684](#)
procaspases, [692–694](#), [693f](#)
processed genes, [360](#)
prochymotrypsin, activation of, [87–88](#), [88f](#)
procollagen, [43](#), [406](#), [539](#), [594](#)
procollagen aminoproteinase, [594](#)
procollagen carboxyproteinase, [594](#)
procollagen suicide, [607](#)
prodrugs, [80](#)
 activation of, [556](#)
product inhibition studies, [79](#)
products
 in balanced chemical equations, [69](#)
 enzyme, [57](#)
proenzymes, enzyme regulation using, [87–88](#), [88f](#)
progeria, [625](#)
progesterone, [484f](#), [485f](#)
 plasma transport of, [498–499](#), [498t](#)
 synthesis of, [487](#), [488f](#), [490f](#)
programmed cell death. *See* apoptosis
prohormones, [406](#)
proinflammatory cytokines, [700](#)
proinsulin, [493–494](#), [494f](#)
prokaryotic gene expression
 eukaryotes compared with, [428–430](#), [428t](#), [429f](#), [430f](#)
 as model for study, [411](#)
 on-off manner of, [424](#)
 unique features of, [411](#)
prolactin (PRL)
 gene location of, [442t](#)

receptors for, 482

proline, 16t

- carbon skeleton catabolism of, 282, 282f
- in collagen, 593–594, 596
- synthesis of, 265, 267f

proline dehydrogenase, deficiency of, 282, 282f

proline hydroxylase, vitamin C as coenzyme for, 539

proline-*cis*, *trans*-isomerases, 42, 42f

prolyl hydroxylase, 43, 266, 593, 596

promoter clearance, 378

promoter recognition specificity, 377

promoter site, in operon model, 411f, 412

promoters, in transcription, 376

- alternative, 388–389, 389f
- bacterial, 379, 380f
- eukaryotic, 379–381, 380f, 381f, 382f, 383

pro-opiomelanocortin (POMC) peptide family, 496–497, 497f

pro-oxidants, antioxidants as, 544–545, 544t

prophage state, 415

propionate

- glucose derived from, 177
- metabolism of, 173f, 174, 174f, 723t

propionyl-CoA

- in citric acid cycle, 153, 154f
- in fatty acid oxidation, 209
- methionine conversion to, 288, 290f, 291f

propionyl-CoA carboxylase, 174, 174f

proprotein convertase subtilisin/kexin type 9 (PCSK9), 253

proteins, 43, 87, 406

proPTH, 494, 495f

propyl gallate, as antioxidant/food preservative, 204

PRO-Seq, 447

prostacyclin (PGI₂), 670, 671f, 672

prostacyclins (PGIs), 197

- clinical significance of, 226–227
- synthesis of, 224, 226f

prostaglandin E₂ (PGE₂), 197, 198*f*
prostaglandin H synthase, 224
prostaglandin I₂ (PGI₂), 224
prostaglandins (PGs), 197–198, 198*f*, 216, 224, 662
 cyclooxygenase pathway in synthesis of, 224–225, 225*f*, 226*f*
prostanoids, 197
 clinical significance of, 224, 226–227
 cyclooxygenase pathway in synthesis of, 224–225, 225*f*, 226*f*
prostate-specific antigen (PSA), 700
prostatic acid phosphatase, diagnostic use of, 64
prosthetic groups
 of enzymes, 57–58, 58*f*
 flavins, 112, 113*f*, 114–115, 115*f*
 heme. *See* heme
 protoheme, 114
protamine, 677
protease-activated receptor-1 (PAR-1), in platelet aggregation, 670, 671*f*
protease-activated receptor-4 (PAR-4), in platelet aggregation, 670, 671*f*
proteases, 9
 as digestive enzymes, 521
 enzyme regulation using, 87–88, 88*f*
 α2-macroglobulin and, 638, 638*f*
 matrix, 576
 phagocyte-derived, 661–662
 in protein degradation, 584–585
 proteins degradation by, 270–271, 270*f*, 271*f*
 synaptobrevin and, 587
26S proteasome, 84
proteasomes
 protein degradation by, 84–85, 270–271, 270*f*, 271*f*
 protein degradation in, 582, 584–585, 585*f*
 structure of, 270–271, 271*f*
protein blot procedure, 438, 439*f*
protein C, 677
protein coding RNAs. *See* messenger RNA
protein damage, repairing of, 714–715, 715*f*

Protein Data Bank, [38](#)
protein degradation, ubiquitin in, [585](#), [585f](#)
protein disulfide isomerase, [41–42](#)
protein disulfide isomerase (PDI), [584](#)
protein folding
 chaperones and, [574–575](#)
 misfolded, [584–585](#), [585f](#), [585t](#)
protein genes s36 and s38, chorion, [429f](#)
protein kinase A (PKA), [504–505](#), [505f](#)
protein kinase C (PKC), [507](#), [507f](#)
 in platelet aggregation, [670](#), [671f](#)
protein kinases
 cAMP and, [504–505](#), [505f](#)
 in hormonal regulation of lipolysis, [246](#), [246f](#)
 hormone signaling and, [508–511](#), [509f](#), [510f](#)
 in initiation of protein synthesis, [399](#)
 phosphorylation by, [87–90](#), [88f](#), [89t](#)
 as second messengers, [482](#), [483t](#)
protein lipidation, [463](#)
protein misfolding
 endoplasmic reticulum accumulation of, [584](#), [585t](#)
 ubiquitination of, [585–586](#), [585f](#)
protein phosphatase-1, [168](#), [169f](#), [170](#), [171f](#)
protein phosphatases, dephosphorylation by, [87–90](#), [88f](#), [89t](#)
protein prenylation, [251](#)
protein S, [677](#)
protein sequencing
 Edman reaction for, [27–28](#), [27f](#)
 genomics and, [28](#)
 mass spectrometry for, [28–30](#), [28t](#), [29f](#), [30f](#)
 molecular biology techniques for, [28](#)
 proteomics and, [30–31](#)
 purification techniques for, [23–26](#), [25f](#), [26f](#), [27f](#)
 Sanger’s work in, [26–27](#)
protein sorting
 branches of, [575](#), [575f](#)
 cell nucleus and, [575f](#), [576–579](#), [577t](#), [578f](#)

cotranslational insertion and, 582–583, 582*f*, 583*f*
disorders of, 589–590
Golgi apparatus in, 574, 575*f*, 584
importins and exportins in, 578, 578*f*
KDEL amino acid sequence and, 574*t*, 583
membrane assembly and, 588–590, 589*f*, 590*t*
misfolded proteins, 584–585, 585*f*, 585*t*
mitochondria and, 576, 577*f*
peroxisomes and, 579, 579*f*
peroxisomes/peroxisome disorders and, 579–580, 580*t*
quality control in, 584, 584*t*
retrograde transport and, 582–584
rough ER branch of, 574, 574*f*, 575*f*
signal hypothesis of polyribosome binding, 574, 574*f*, 580–582, 580*t*,
581*f*, 582*f*
signal sequences and, 573–575, 574*t*, 582*f*, 629
transport vesicles and, 585–588, 586*t*, 587*f*

protein synthesis, 134
antibiotic inhibition of, 406–407, 407*f*
biomedical importance of, 393
elongation in, 402–403, 403*f*, 403*t*
environmental threats and, 405
genetic information flow of, 393–394
in Golgi apparatus, 574, 575*f*
initiation of, 399–402, 400*f*, 401*f*
by mitochondria, 574*t*, 576
modular principles in, 34
mRNA and, 344, 344*f*, 394, 394*t*
mutations and, 396–398, 396*f*, 397*f*, 398*f*
polysomes in, 405, 574, 574*f*
posttranslational processing and, 406
rate of, 269–270, 401–402, 402*f*
with recombinant DNA technology, 441–442
regulation of, 84
reticulocytes and, 649
RNA and, 343–344
termination of, 403–404, 404*f*

- translocation and, [403](#)
- tRNA and, [395–396](#), [395f](#), [396f](#)
- virus replication and, [405–406](#), [406f](#)
- protein turnover, [84](#), [269–270](#)
 - in membranes, [589](#)
- proteinases, of cancer cells, [698](#)
- protein-conducting channel, [580](#)
- protein-DNA interactions
 - bacteriophage lambda as paradigm for, [414–418](#), [414f](#), [415f](#), [416f](#), [417f](#)
 - mapping of, [446–447](#)
- protein-losing gastroenteropathy, [630](#)
- protein-protein cross-links and protein glycation, [714f](#)
- protein–protein interactions, identification of, [447](#), [449f](#)
- protein-RNA complexes, in initiation, [399](#), [400f](#), [401](#)
- proteins
 - acute phase, [526](#), [630](#), [630t](#)
 - aggregates of, [41](#)
 - l- α -amino acids in, [15](#), [15t–16t](#), [17](#)
 - asymmetry of, in membrane assembly, [589](#), [589f](#)
 - biomedical importance of, [23](#)
 - classification of, [34](#)
 - configuration of, [33–34](#)
 - conformations of, [33–35](#), [34f](#), [41–42](#)
 - constitutive, [84](#)
 - degradation of
 - amino acid levels and, [271–272](#), [271f](#), [272f](#)
 - ATP- and ubiquitin-dependent, [270–271](#), [270f](#), [271f](#)
 - ATP-independent, [270](#)
 - biomedical importance of, [269](#)
 - disorders of, [276–278](#), [277t](#)
 - end products of, [272](#), [275](#), [275f](#)
 - protease and peptidase role in, [270–271](#), [270f](#), [271f](#)
 - rate of, [269–270](#)
 - regulation of, [84–85](#)
 - denaturation of, [41](#)
 - diets deficient in, [263–264](#)
 - digestion and absorption of, [521](#), [523](#)

domains of, 37, 38f, 39f
dual-function, 487
energy yields from, 138t
in extracellular and intracellular fluid, 460, 460t
folding of, 41–42, 42f
 calnexin role in, 551–552
free radical damage to, 541–542, 542f
function of, bioinformatics and, 31
fusion, 65–66, 66f
in genetic information flow, 393–394
glycoproteins. *See* glycoproteins
half-lives of, 270
homologous, 61
hormone receptors as, 482
identification of
 genomics role in, 28
 mass spectrometry role in, 28–30, 28t, 29f, 30f
 proteomics and, 30–31
import of
 by cell nucleus, 576–579, 578f
 by mitochondria, 576, 577t
 by peroxisomes, 579, 579f
intracellular traffic of, 573
ion channels as transmembrane, 470–471, 470f, 471f, 471t
life cycle of, 23, 24f
lysosomal, 590
maturation of
 folding, 41–42, 42f
 posttranslational processing, 42–44, 43f
in membranes. *See also* membrane proteins
 in artificial, 465
 lipid ratio to, 460–461, 460f
as metabolic fuel, 130, 136
metabolic pathways of, 130f, 131, 131f, 132f
 in fasting state, 138, 138t
 in fed state, 137f, 138, 138t
 at tissue and organ levels, 132–133, 132f, 133f

misfolded, [584–586](#), [585f](#), [585t](#)
modifications of, [384](#)
of neutrophils, [659](#), [659t](#)
noncovalent interactions in, [8](#)
nutritional requirements for, [525–526](#)
phospholipid exchange, [464](#)
plasma. *See* plasma proteins
plasma transport, [498–499](#), [498t](#)
posttranslational processing of, [406](#)
prenylation of, [251](#)
profiling of, [446–447](#)
purification of
 chromatographic techniques, [23–26](#), [26f](#), [27f](#)
 gel electrophoresis, [26](#), [26f](#), [27f](#)
 isoelectric focusing, [26](#), [27f](#)
ROS reactions with, [711f](#)
sequences or molecules that direct, [573](#), [574t](#)
sequencing of. *See* protein sequencing
structure of
 biomedical importance of, [33](#)
 biophysical techniques for solving of, [39–41](#)
 conformation versus configuration, [33–34](#)
 folding into, [41–42](#), [42f](#)
 gross characteristics, [34](#)
 modular nature of, [34](#)
 orders of, [34](#)
 pathologic perturbations of, [42](#)
 posttranslational processing of, [42–44](#), [43f](#)
 primary. *See* primary structure
 quaternary. *See* quaternary structure
 secondary. *See* secondary structure
 tertiary. *See* tertiary structure
volatilization of, [29–30](#), [30f](#)

proteinuria, 566

proteoglycans, 147

- accumulation of, 235
- in cartilage, 607–608, 608*f*, 608*t*
- components of, 599, 599*f*, 600*f*
- disease and aging with, 604
- functions of, 600–601, 603*t*
- galactose production for, 187–188, 189*f*
- glucuronate production for, 186–187, 187*f*
- O-glycosidic linkages in, 549

proteolysis, 588

- enzyme regulation by, 86–88, 88*f*

proteome, 30–31

proteomics, 3, 447

- bioinformatics and, 31
- challenges in, 31
- goal of, 30–31

prothrombin, 672, 673*f*, 673*t*, 674*t*

- coumarin drugs and, 677–678
- factor Xa activation of, 674–675, 675*f*

prothrombinase complex, 674–675, 675*f*

protic acids, 93

protoheme, 114

proton acceptors, bases as, 10

proton donors, acids as, 10

proton gradient, of respiratory chain, 121, 122*f*

proton motive force, of respiratory chain, 121, 122*f*

proton pump, respiratory chain action as, 118–121, 119*f*, 120*f*, 121*f*

proton shuttle, 61, 61*f*

proton-motive force, 576

protons

- hemoglobin binding of, 52–53, 53*f*
- in water, 9–10

proto-oncogenes, 685, 686*f*

protoporphyrin III, in heme synthesis, 307, 308*f*, 309*f*

protoporphyrinogen III, in heme synthesis, 307, 308*f*, 309*f*

protoporphyrinogen oxidase, 307, 308*f*, 309*f*, 310*t*

proximity, enzymatic catalysis by, 59
PRPP. *See* phosphoribosyl pyrophosphate
PRPP glutamyl amidotransferase, in purine synthesis, 330–331, 331f
PRPP synthetase
 defect in, gout caused by, 334, 336t
 in purine synthesis, 330, 331f, 334, 334f
 in pyrimidine synthesis, 334, 334f
PSA (prostate-specific antigen), 700
pseudo-first-order conditions, 71, 73
pseudogenes, 360
pseudouridine, 336, 337f
psi angle, 34, 34f
PstI, 433t
PstI site, insertion of DNA at, 437, 437f
pterins, 95, 96f
PTH. *See* parathyroid hormone
PTSs (peroxisomal–matrix targeting sequences), 574t, 579, 579f
PTT. *See* activated partial thromboplastin time
“puffs,” polytene chromosome, 354, 354f
pumps, 467, 467f, 473
punctuation of genetic code, 395
purification
 of glycoproteins, 547
 of proteins and peptides
 chromatographic techniques, 23–26, 26f, 27f
 gel electrophoresis, 26, 26f, 27f
 isoelectric focusing, 26, 27f
purine nucleoside phosphorylase deficiency, 327, 335, 336t
purines
 biomedical importance of, 320
 chemistry of, 320, 320f
 derivatives of, 320–321, 322t
 dietary nonessential, 328
 in DNA, 338–339, 339f
 gout and, 334
 metabolism of
 biomedical importance of, 327–328

- disorders of, [334–335](#), [336t](#)
- in RNA, [342](#), [343f](#)
- serine conversion to, [300](#)
- substitution mutation of, [396–397](#), [396f](#), [397f](#), [398f](#)
- synthesis of, [328](#), [328f](#), [329f](#), [330](#), [330f](#)
 - pyrimidine synthesis coordinated with, [334](#), [334f](#)
 - regulation of, [332](#), [332f](#), [334](#), [334f](#)
- synthetic analogs of, [324f](#)
- ultraviolet light absorption by, [321](#)
- puromycin, [407](#), [407f](#)
- purple acid phosphatases, iron in, [97](#)
- pyranose ring structures, [143](#), [143f](#)
- pyridoxal. *See* vitamin B₆
- pyridoxal phosphate (PLP), [273](#), [273f](#), [535](#)
- pyridoxamine. *See* vitamin B₆
- pyridoxine. *See* vitamin B₆
- pyrimethamine, [537](#)
- pyrimidines
 - biomedical importance of, [320](#)
 - chemistry of, [320](#), [320f](#)
 - derivatives of, [320–321](#), [322t](#)
 - dietary nonessential, [328](#)
 - in DNA, [338–339](#), [339f](#)
 - metabolism of, [335f](#)
 - biomedical importance of, [327–328](#)
 - diseases caused by catabolite overproduction and, [336](#), [336t](#)
 - water-soluble metabolites of, [335–336](#), [337f](#)
 - precursors of, deficiency of, [336](#)
 - in RNA, [342](#), [343f](#)
 - serine conversion to, [300](#)
 - substitution mutation of, [396–397](#), [396f](#), [397f](#), [398f](#)
 - synthesis of, [328](#), [332](#), [333f](#)
 - analogs in, [334](#)
 - catalysts in, [332](#), [333f](#)
 - purine synthesis coordinated with, [334](#), [334f](#)
 - regulation of, [332](#), [332f](#), [334](#), [334f](#)

- synthetic analogs of, [324f](#)
- ultraviolet light absorption by, [321](#)

pyrophosphatase

- in fatty acid activation, [208](#)
- in glycogenesis, [164](#), [165f](#)
- in RNA synthesis, [378](#)

pyrophosphate (PP_i)

- in fatty acid activation, [208](#), [208f](#)
- in glycogenesis, [164](#), [165f](#)
- in RNA synthesis, [378](#)

pyrrole rings, of porphyrins, [305](#), [306f](#)

Δ¹-pyrroline-5-carboxylate dehydrogenase, [282](#), [282f](#)

pyruvate, [136](#), [138](#)

- in citric acid cycle, [153](#), [154f](#)
- in gluconeogenesis, [172–173](#), [173f](#)
- glycolysis production of, [157](#), [158f](#), [158t](#), [159–160](#), [159f](#)
- inhibition of metabolism of, [163](#)
- in transamination reactions, [272–273](#), [273f](#)

pyruvate carboxylase, [153–154](#), [154f](#)

- in gluconeogenesis, [172](#), [173f](#)
- regulation of, [175](#)

pyruvate dehydrogenase (PDH)

- deficiency of, [163](#)
- heavy metal inactivation of, [94](#)
- in pyruvate oxidation, [161](#), [162f](#)
- regulation of, [89t](#), [155–156](#), [161–163](#), [162f](#)
 - acyl-CoA in, [221](#)

pyruvate dehydrogenase complex, [161](#), [162f](#)

pyruvate kinase

- deficiency of, [163](#)
- in glycolysis, [159–160](#), [159f](#)
- regulation of, [161](#), [175](#)
- reversal of reaction catalyzed by, [172–173](#), [173f](#)

pyruvate kinase (PK)

- in cancer cells, [696](#), [697f](#)
- deficiency of, [650t](#), [651](#)

pyruvate oxidation, [161–163](#), [162f](#)
induction and repression of enzymes catalyzing, [174–175](#), [175t](#)

Q

Q. *See* coenzyme Q

Q cycle, [120](#), [121f](#)

Q₁₀. *See* temperature coefficient

Q-cytochrome *c* oxidoreductase (Complex III), [118](#), [119f](#), [120](#), [120f](#), [121f](#)

QT interval, congenitally long, [478t](#)

quadrupole mass spectrometers, [28](#), [29f](#)

quality control, for laboratory tests, [561](#)

quaternary structure, [36–37](#), [38f](#), [39f](#)

of hemoglobin, [50–53](#), [50f](#), [51f](#), [52f](#), [53f](#)

as order of protein structure, [34](#)

schematic diagrams of, [38–39](#)

stabilizing factors in, [39](#)

R

α -R groups, of amino acids, [20](#)

R state. *See* relaxed state

Rab effector proteins, [586t](#), [587](#)

Rab molecules, [587](#)

Rab proteins, [586–588](#), [586t](#)

radiation

carcinogenic effect of, [683](#), [683t](#)

DNA damage caused by, [370f](#), [370t](#)

radioimmunoassays, laboratory tests using, [565](#)

Ramachandran plot, [34f](#)

Ran proteins, [578](#)

rancidity, peroxidation causing, [203](#)

random-order reactions, [79](#), [79f](#)

RAS oncogene, [685](#), [685t](#), [687t](#)

rate constant (*k*), [71–72](#)

rate of reaction

activation energy and, [69–70](#), [70f](#), [72](#)

enzyme effects on, [72](#)

Gibbs free-energy change and, [69](#)

hydrogen ion concentration effects on, 72–73, 73f
initial velocity, 73–76, 73f, 75f, 76f, 79, 80f
maximal velocity. *See* maximal velocity
Michaelis constant. *See* Michaelis constant
substrate concentration effects on, 71, 73–74, 73f, 74f
temperature effects on, 70, 71f, 72

rate-limiting reactions, 84

RB gene, 687t, 691

Rb protein. *See* retinoblastoma protein

reactants. *See* substrates

reactive oxygen species (ROS), 649, 709
antioxidant paradox and, 544–545, 544t
in cancer development, 683, 700
chain reactions and, 710
damage caused by, 541–542, 542f
enzymatic and chemical mechanisms intercept damaging, 713
heavy metal formation of, 94
hydroperoxidase reactions with, 114
in lipid peroxidation, 204, 204f
mechanisms protecting against, 543–544, 544f
reaction with biological molecules, 711f
respiratory burst generation of, 660
self-perpetuating chain reactions of, 541
sources of, 542–543, 543f
superoxide dismutase reactions with, 116
as toxic byproducts of life, 710f

receptor-corepressor complex, 502

receptor-effector coupling, 482

receptor-mediated endocytosis, 474f, 475

recombinant DNA technology
applications of
gene mapping, 441
microsatellite polymorphisms, 445–446
molecular analysis of disease, 442–445, 443f, 444f, 444t
practical, 441
protein production, 441–442
restriction fragment length polymorphism, 445

- single nucleotide polymorphisms, 445
- targeted gene regulation, 446–447
- biomedical importance of, 432
- blotting and probing techniques for, 438, 439*f*
- chimeric molecules in, 432
- cloning in, 435–438, 436*f*, 437*f*, 437*t*
- DNA sequencing, 439, 440*f*
- enzyme studies using, 65–66, 66*f*
- genomic library for, 438
- hematology and, 655
- library probe for, 438
- oligonucleotide synthesis, 439
- polymerase chain reaction method, 439–440, 441*f*
- restriction enzymes in
 - for chimeric DNA molecule preparation, 434–435
 - DNA chain cleavage with, 433–434, 434*f*
 - selection of, 433–434, 433*t*, 434*t*
- recombinant fusion proteins, 65–66, 66*f*
- recombinant t-PA, 679
- recombinases, 434*t*, 435
- recombination, chromosomal, 359, 359*f*, 360*f*
- recruitment hypothesis, 386
- red blood cells
 - ABO system, 653–654, 654*f*
 - biomedical importance of, 646
 - CO₂ transport by, 648
 - derivation from hematopoietic stem cells, 646–647, 647*f*
 - diseases affecting, 646, 650*t*
 - functions of, 647–648, 647*f*, 648*t*
 - glycolysis of, 648, 648*t*
 - lifespan of, 648–649
 - membrane of, 651–653, 651*f*, 652*f*, 652*t*
 - replacement of, 648–649
- red thrombus, 670
- redox potential (E'_0)
 - free energy changes and, 111–112, 112*t*

of transition metals in organometallic complexes, 95–97

redox reactions

- biomedical importance of, 111
- free energy changes of, 111–112, 112*t*
- iron participation in, 97

redox state, 210

reducing equivalents

- citric acid cycle production of, 151–153, 152*f*
- pentose phosphate pathway generation of, 185
- respiratory chain oxidation of, 118–121, 119*f*, 120*f*, 121*f*

5 α -reductase, 487, 489*f*

reduction

- definition of, 111
- dehydrogenase reactions, 112–114, 113*f*
- hydroperoxidase reactions, 114
- of oxygen by Complex IV, 120–121
- redox potential and, 111–112, 112*t*

reference range, of laboratory tests, 561

Refsum disease, 215, 580, 580*t*

regional heterogeneities, 464

regulated secretion, 574

regulation. *See* metabolic regulation

regulatory domains, 37

regulatory enzymes, of metabolic pathways, 135

regulatory transcription factor proteins, DNA-binding domains of, 425*t*

- helix-turn-helix motif, 425–426, 426*f*
- leucine zipper motif, 427, 427*f*
- zinc finger motif, 426, 426*f*

relaxation phase of muscle contraction, 616

relaxed form of DNA, 341

relaxed (R) state, of hemoglobin, 50–52, 51*f*, 52*f*

releasing factor 1 (RF1), 403, 404*f*

releasing factor 3 (RF3), 403–404, 404*f*

remnant removal disease, 258*t*

renal glomerulus, 598

renaturation, DNA, base pair matching and, 341

rennin, 56

repair mechanisms and proofreading for DNA, 713–714
repetitive-sequence DNA, 357–358
replication. *See* DNA, replication and synthesis of
replication bubbles, 364, 366*f*, 367–368, 367*f*
replication fork, 362*f*, 363, 366*f*
replication mutations, 683
replication protein A (RPA), 364
replicative senescence, 716
reporter gene approach, 422*f*, 423, 424*f*
repression, of enzyme synthesis, 84
repressor gene, lambda (cI), 415, 415*f*
repressor protein, lambda (cI), 415–416, 416*f*
repressors in gene expression, 410–412
reproduction, prostaglandins in, 216
RER. *See* rough endoplasmic reticulum
REs. *See* restriction enzymes
resonance structures, of amino acids, 18–19, 19*f*
respiration, 111
respiratory burst, 525, 660
 free radicals from, 542
respiratory chain
 biomedical importance of, 118
 catabolic energy captured by, 121–122
 citric acid cycle production of substrates for, 150–151, 151*f*
 clinical aspects of, 126
 coenzyme Q in, 118, 119*f*, 120, 120*f*, 121*f*
 complexes of, 118–121, 119*f*, 120*f*, 121*f*
 control of, 122–124, 123*t*
 cytochrome *c* in, 118, 119*f*, 120, 120*f*, 121*f*
 dehydrogenase role in, 112
 electron transport in, 118, 119*f*, 120–121, 120*f*, 122*f*
 flavoproteins and iron-sulfur proteins in, 118–120, 119*f*
 inhibition of, 112, 118, 123–124, 123*f*, 124*f*
 in mitochondrial compartments, 118, 118*f*
 mitochondrial exchange transporters and, 124–126, 124*f*, 125*f*, 126*f*
 oxidation of reducing equivalents by, 118–121, 119*f*, 120*f*, 121*f*
 oxygen reduction in, 120–121

proton gradient of, 121, 122*f*
proton pump action of, 118–121, 119*f*, 120*f*, 121*f*, 122*f*
respiratory chain level phosphorylation, 122
respiratory control, 106, 155
respiratory distress syndrome, surfactant deficiency and, 200, 229, 234
respiratory quotient (RQ), 524
restriction endonucleases
 clinical diagnosis using, 64
 direct observation of, 62*f*
restriction enzymes (REs), 348
 in chimeric DNA molecule preparation, 434–435
 DNA chain cleavage with, 433–434, 434*f*, 434*t*
 selection of, 433, 433*t*
restriction fragment length polymorphisms (RFLPs), 65, 445
restriction map, 434–444
restriction sites, 64
reticulocytes, 649
retina, gyrate atrophy of, 282
retinaldehyde, 529, 529*f*
retinitis pigmentosa, essential fatty acid deficiency and, 224
retinoblastoma protein (Rb protein), oncoproteins and, 369
retinoic acid, 529–530, 529*f*
retinol. *See* vitamin A
retinol activity equivalent, 529
retrograde transport (COPI), 582–584, 586
retrograde vesicular transport, 583
retroposons, 357
retrotranslocation, 584, 585*f*
retroviral genomes, 437
retroviruses, reverse transcriptases in, 344, 367–368
reverse cholesterol transport, 241*f*, 242, 250, 254, 254*f*, 257
reverse transcriptase/reverse transcription, 344, 360, 434*t*
Reye syndrome, 226
 orotic aciduria in, 336
RF1 (releasing factor 1), 403, 404*f*
RF3 (releasing factor 3), 403–404, 404*f*
RFLP (restriction fragment length polymorphisms), 65, 445

rheumatoid arthritis, 592
glycoprotein synthesis defects in, 554
 ω 3 fatty acids and, 199

rho (ρ) factor, 378

rho kinase, 617

rhodopsin, 529, 530*f*

ribbon diagrams, 38

riboflavin. *See* vitamin B₂

riboflavin-linked dehydrogenases, 114

ribomyopathies, 649

ribonucleases, 348

ribonucleic acid. *See* RNA

ribonucleoprotein particles (mRNPs), 405, 405*f*, 430

ribonucleoside diphosphates, 332, 332*f*

ribonucleosides, 320, 321*f*

ribonucleotide reductase
gallium in, 94
iron in, 97

ribonucleotide reductase complex, 332, 332*f*

ribose, 141, 144*f*, 144*t*
metabolic pathways of, 130
in nucleosides, 320, 321*f*
pentose phosphate pathway formation of, 182–185, 183*f*, 184*f*

D-ribose, 320, 321*f*

ribose 5-phosphate, in purine synthesis, 328, 329*f*, 330, 331*f*

ribose-5-phosphate ketoisomerase, in pentose phosphate pathway, 183*f*, 184*f*, 185

ribosomal dissociation, in protein synthesis, 399

ribosomal RNA (rRNA), 343, 374, 375*t*
amplification of, 429, 429*f*
function of, 347
as peptidyl transferase, 402, 403*t*
precursors for, 389
in protein synthesis
elongation, 402–403, 402*f*
initiation, 399, 400*f*, 401
structure of, 347, 347*t*

ribosomes, [134](#), [347](#), [347t](#)
 bacterial, [406–407](#)
 profiling of, [447](#)
 in protein synthesis, [399](#)
 as ribozyme, [66](#)
 structure of, [574](#)

ribothymidine pseudouridine cytidine (TΨC) arm of tRNA, [346f](#), [347](#), [396](#), [396f](#)

ribozymes, [66–67](#), [343](#), [391](#)

ribulose, [144f](#), [144t](#)

ribulose-5-phosphate, in pentose phosphate pathway, [183–185](#), [183f](#), [184](#), [184f](#)

ribulose-5-phosphate 3-epimerase, in pentose phosphate pathway, [183f](#), [184f](#), [185](#)

Richner-Hanhart syndrome, [286](#), [287f](#)

ricin, [407](#)

ricketts, [531–532](#)

Rieske iron centers, [97](#), [98f](#), [120](#), [121f](#)

right operator, [415](#), [415f](#)

right-handed triple- or superhelix, [593](#), [593f](#)

rigor mortis, [616](#)

RISC (RNA-induced silencing complex), [391](#)

RNA
 biomedical importance of, [338](#), [374](#)
 catalysis by, [66–67](#)
 as catalysts, [391](#)
 in chromatin, [351](#)
 circular, [348](#)
 classes/species of, [344–348](#), [374](#), [375t](#)
 complementarity of, [342–343](#), [344f](#), [346](#)
 in genetic information flow, [393–394](#)
 long noncoding, [348](#), [374](#), [375t](#)
 messenger. *See* messenger RNA
 micro. *See* micro-RNAs
 modification of
 of mRNA, at 5' and 3' ends, [389–390](#)
 mRNA sequence alteration, [391](#)

- pri-miRNA, [389–390](#), [390f](#)
- tRNA processing and, [391](#)
- mutations caused by changes in, [396–398](#), [396f](#), [397f](#), [398f](#), [411](#)
- noncoding. *See* noncoding RNAs
- as polynucleotides, [325](#)
- processing of
 - alternative, gene expression and, [430](#)
 - alternative promoter utilization in, [388–389](#), [389f](#)
 - alternative splicing, [388](#), [388f](#)
 - in gene expression regulation, [428](#), [428t](#)
 - of rRNAs and tRNAs, [389](#)
 - sequences to remove, [386](#), [387f](#), [388f](#)
 - after transcription, [386](#)
- profiling of, [446–447](#)
- in protein synthesis, [343–344](#)
- ribosomal. *See* ribosomal RNA
- silencing. *See* silencing RNAs
- small, [347–348](#)
- small, heterogeneous regulatory, [348](#)
- small nuclear. *See* small nuclear RNA
- splicing of, [386–388](#), [387f](#)
 - alternative, [388](#), [388f](#)
- structure of, [342–343](#), [343f](#), [344f](#), [345f](#), [346f](#)
- synthesis of, [339](#). *See also* transcription
 - cyclical process of, [378–379](#)
 - DNA synthesis compared with, [375](#)
 - DNA template strand for, [375](#), [375f](#)
 - RNA polymerase in, [375–377](#), [376f](#), [377f](#)
- transfer. *See* transfer RNA
- in viruses, [344](#)

RNA blot procedure, [438](#), [439f](#)

RNA editing, [391](#)

RNA polymerase II

- activators and coregulators and, [384–385](#), [385t](#)
- formation of, [383–384](#)
- phosphorylation activation of, [384](#), [385f](#)
- RNA processing and, [386](#), [387f](#)

termination signals for, [383](#)
in transcription, [380–381](#), [380f](#), [381f](#), [382f](#)

RNA polymerases (RNAP)
bacterial, [377](#), [377f](#)
initiation by, [375–377](#), [376f](#), [377f](#)
mammalian, [378](#), [378t](#)
in operon model, [412](#), [413f](#), [414](#)

RNA primer, in DNA synthesis, [362f](#), [362t](#), [363–364](#), [365f](#), [366f](#)

RNA recognition motifs (RRM), [387](#)

RNA world, [66–67](#)

RNA-dependent DNA polymerase, [360](#)

RNA-induced silencing complex (RISC), [391](#)

RNAP. *See* RNA polymerases

RNA-RNA hybridization, [348](#)

RNase H, [434t](#)

RNA-Seq, [447](#)

ROS. *See* reactive oxygen species

Rossmann fold, [37](#)

rough endoplasmic reticulum (RER)
binding to, [575f](#), [580–582](#), [580t](#), [581f](#), [582f](#)
in protein sorting, [574](#), [574f](#), [585f](#)
protein synthesis and, [405](#)
routes of protein insertion into, [582–584](#), [582f](#), [583f](#)

rough ER branch, of protein sorting, [574](#), [574f](#), [575f](#)
cotranslational pathway, [580–581](#), [581f](#)
posttranslational translocation, [581–582](#), [582f](#)
N-terminal signal peptides in, [580](#), [580t](#)

Rous sarcoma virus (RSV), [685](#)

RPA (replication protein A), [364](#)

RQ (respiratory quotient), [524](#)

RRM (RNA recognition motifs), [387](#)

rRNA. *See* ribosomal RNA

RSV (Rous sarcoma virus), [685](#)

ryanodine, [618](#)

S

S phase of cell cycle, DNA synthesis during, [368–369](#), [368f](#), [369f](#), [369t](#)

S1 nuclease, in recombinant DNA technology, [434t](#)
S₅₀, [76](#), [76f](#)
SADDAN phenotype, [609](#)
salt bridges, [8](#)
 in hemoglobins, [52–53](#)
 in protein tertiary and quaternary structures, [39](#)
“salvage” reactions
 in purine synthesis, [330](#), [331f](#)
 in pyrimidine synthesis, [332–333](#)
samples, for laboratory analysis, [563](#)
sandwich assay, laboratory tests using, [565](#)
Sanfilippo syndrome, [604t](#)
Sanger, Frederick, sequencing work of, [26–27](#)
Sanger reagent, [27](#)
sarcoglycan, [622](#), [623f](#)
sarcolemma, [612](#)
sarcomere, [612](#), [612f](#)
sarcoplasm, [612](#)
sarcoplasmic reticulum, [618](#), [618f](#)
sarcosine, [300–301](#)
saturated acyl enzyme, [217](#), [219f](#)
saturated fatty acids, [196](#), [196f](#), [197](#), [197t](#)
 in membranes, [461–462](#), [461f](#)
saturation kinetics, [76](#)
scaffolding, [352f](#), [353](#)
scavenger receptor B1, [241f](#), [242](#)
screening, for new drugs, [80](#)
scurvy, [43](#), [263](#), [266](#), [540](#), [596](#)
SDs (silencing domains), [428](#), [428f](#)
SDS-PAGE (sodium dodecyl sulfate polyacrylamide gel electrophoresis),
 protein and peptide purification with, [26](#), [26f](#)
Sec12p, [586](#)
Sec61 complex, [581](#)
Sec61/Sec63 complex, [581](#)
second law of thermodynamics, [106](#)
second messengers, [482](#), [483t](#), [502](#). *See also* signal generation
 cGMP as, [323](#)

- enzyme regulation by, 86
- phosphatidylinositide as, 200, 200*f*
- phospholipids as, 229
- secondary lysosomes, 474
- secondary structure
 - α helices, 35–36, 35*f*, 37*f*
 - β sheets, 36, 36*f*, 37*f*
 - of collagen, 43, 43*f*
 - folding into, 41
 - loops and bends, 36, 37*f*
 - of myoglobin and hemoglobin, 50
 - as order of protein structure, 34
 - peptide bond restrictions on, 34–35, 34*f*
- secondary structure, of RNA, 342, 343*f*, 346*f*
- secondary transport, 469
- second-order rate constant, 71
- secretory (exocytotic) pathway, 574
- secretory proteins, 581
- secretory vesicles, 574, 575*f*
- selectins, 553–554
- selective permeability
 - of inner mitochondrial membrane, 124–126, 124*f*, 125*f*, 126*f*
 - membrane, 459, 470, 470*f*
- selective proteolysis, enzyme regulation by, 86–88, 88*f*
- selectivity filter, 470, 471
- selenium, 204, 244
 - in glutathione peroxidase, 114, 185–186, 186*f*
 - human requirement for, 93, 93*t*
- selenocysteine, 15, 17, 17*f*
 - synthesis of, 267–268, 268*f*
- selenophosphate synthetase, 268, 268*f*
- self-assembly
 - of collagen, 594
 - of lipid bilayer, 462
- self-association, of hydrophobic molecules in aqueous solutions, 8
- semidiscontinuous DNA synthesis, 362*f*, 364, 366*f*
- semiquinone, 120, 121*f*

senscence, DNA damage and, [371](#), [371f](#)
sensitivity, of laboratory test, [562](#), [563t](#)
sensory neuropathy, vitamin B₆ causing, [535](#)
sequence classes, of genome, [357](#)
sequence-specific DNA methylases, [433](#)
sequencing
 of DNA, [439](#)
 of proteins and peptides. *See* protein sequencing
sequential reactions, [79](#), [79f](#)
serine, [15t](#)
 carbon skeleton catabolism of, [283](#), [284f](#)
 specialized products of, [300](#)
 synthesis of, [265](#), [266f](#)
serine protease inhibitor, [638](#)
serine proteases, covalent catalysis of, [60–61](#), [61f](#)
serine–arginine motifs (SR), [387](#)
serotonin, tryptophan conversion to, [300](#), [301f](#)
serpin, [638](#)
serum amyloid P component, [639](#)
serum bilirubin, [313](#), [315](#), [315t](#), [566](#)
serum complement components, [472](#)
serum enzyme analysis, [63–64](#), [64t](#), [65f](#)
serum samples, [563](#)
sex hormones, cholesterol as precursor for, [202](#), [249](#)
sex-hormone-binding globulin (SHBG), [499](#), [499t](#)
SGLT1 transporter, [520](#), [520f](#)
SH2 (Src homology 2), [508](#), [509f](#)
SHBG (sex-hormone-binding globulin), [499](#), [499t](#)
short interspersed nuclear elements (SINEs), [357–358](#)
sialic acids, [147](#), [148f](#), [148t](#), [202](#)
 in gangliosides, [234](#), [234f](#)
 synthesis of, [188](#), [190f](#)
sialidosis, [603](#)
sickle cell anemia, [650t](#)
sickle cell disease, [397f](#)
 hemoglobin mutations in, [54](#), [54f](#)
 pedigree analysis of, [443–444](#), [444f](#)

- point mutation in, 442, 443*f*
- prenatal diagnosis of, 444–445, 445*f*
- technology for, 432
- signal generation
 - in group I hormones, 501–502, 501*f*, 501*t*, 502*f*
 - in group II hormones
 - calcium, 507
 - cAMP, 503–506, 503*t*, 504*t*, 505*f*
 - cGMP, 506
 - G-protein–coupled receptors, 503, 503*f*
 - intracellular, 502–503
 - phosphatidylinositide, 507–508, 507*f*, 508*f*
 - protein kinases, 508–511, 509*f*, 510*f*
- signal hypothesis of polyribosome binding, 574, 574*f*, 580–582, 580*t*, 581*f*, 582*f*
- signal peptidase, 581, 581*f*, 629
- signal peptide, 574
 - of albumin, 630
 - in protein sorting, 574*f*, 576, 577*f*, 580–582, 581*f*, 582*f*
- signal recognition particle (SRP), 580–581, 581*f*, 629
- signal recognition particle (SRP) receptor, 580–581, 581*f*
- signal sequences, 573–575, 574*t*, 582*f*, 629
- signal transducers and activators of transcription (STATs), 509, 510*f*
- signal transduction
 - CBP/p300 and, 513–514, 513*f*
 - of hormones, 500–501, 501*f*
 - across membranes, 459, 467*t*, 475–476
- silencers, of gene expression, 410
 - DNA elements, 422–423
 - tissue-specific expression of, 423
- silencing, of gene expression, 87
- silencing domains (SDs), 428, 428*f*
- silencing RNAs (siRNAs), 348, 374, 375*t*
 - gene expression modulation by, 428–429
 - synthesis of, 390–391, 390*f*
- silent mutations, 396, 396*f*
- simple competitive inhibition, 77, 77*f*

simple diffusion, [467–468](#), [467f](#), [467t](#), [468f](#)
simple lipids, [196](#)
simple noncompetitive inhibition, [77–78](#), [78f](#)
simvastatin, [257](#)
SINEs (short interspersed nuclear elements), [357–358](#)
single nucleotide polymorphisms (SNPs), [442](#), [445](#)
single quadrupole mass spectrometers, [28](#), [29f](#)
single-cell sequencing, in cancer research, [701](#)
single-displacement reactions, [79](#), [79f](#)
single-molecule enzymology, [62](#), [62f](#)
single-strand binding proteins (SSBs), [362f](#), [363–364](#), [363t](#)
single-stranded DNA (ssDNA), [361](#)
siRNA-miRNA complexes, [348](#)
siRNAs. *See* silencing RNAs
sirtuins, [89](#)
sister chromatids, [355](#), [355f](#), [361](#), [361f](#)
site-directed mutagenesis, enzyme studies using, [66](#)
site-specific integration, [360](#)
size-exclusion chromatography, [24–25](#), [25f](#)
Sjögren-Larsson syndrome, [226](#)
skeletal muscle, [612](#), [619t](#)
 actin-based regulation in, [616](#)
 glucose uptake by, [136–137](#), [137f](#)
 glycogen, supplies of, [620](#)
 lactate production by, [160](#)
 malignant hyperthermia of, [618–619](#), [620t](#)
 metabolic role of, [133](#)
 as protein reserve, [623](#)
 sarcoplasmic reticulum in, [618](#), [618f](#)
 twitch fibers of, [621](#)
skin
 calcitriol synthesis in, [489–490](#), [490f](#)
 diseases of, [625](#)
 essential fatty acid deficiency and, [225](#)
 vitamin D synthesis in, [530](#), [531f](#)
skin bleeding time, [679](#)
sleep, prostaglandins in, [216](#)

slow twitch fibers, 621

slow-reacting substance of anaphylaxis, 227

Sly syndrome, 604*t*

SMAC, in apoptosis, 693*f*, 694

small, heterogeneous regulatory RNAs (sRNAs), 348

small nuclear RNA (snRNA), 343–344, 344*t*, 347, 374, 375*t*

- in alternative splicing, 388
- in RNA processing, 386–388

small RNA, 347–348

smooth muscle, 612, 619*t*

- actin-myosin interactions in, 617, 617*t*
- regulation of contraction by myosin, 616–618, 617*f*, 617*t*

SNAP (soluble NSF attachment factor) proteins, 586*t*, 587*f*, 588

SNARE pin, 588

SNARE proteins, 586–588, 586*t*, 587*f*

SNPs (single nucleotide polymorphisms), 442, 445

snRNA. *See* small nuclear RNA

sodium (Na⁺)

- in extracellular and intracellular fluid, 460, 460*t*
- permeability coefficient of, 463*f*

sodium dodecyl sulfate polyacrylamide gel electrophoresis (SDS-PAGE),
protein and peptide purification with, 26, 26*f*

sodium-potassium pump (Na⁺-K⁺-ATPase), 472–473, 472*f*, 473*f*

SODs. *See* superoxide dismutases

solubility

- of amino acids, 20, 20*f*
- of lipids, 196

soluble NSF attachment factor (SNAP) proteins, 586*t*, 587*f*, 588

soluble proteins, 34, 581

solvent, water as ideal, 6–7, 7*f*

somatic mutation theory of aging, 714

sonication, mild, 465

sorbitol, in diabetic cataract, 190–191

sorbitol dehydrogenase, 186, 188*f*

sorbitol pathway, 190–191

Soret band, 308, 310*f*

Southern (DNA/DNA) blotting, 341

Southern DNA blot transfer procedure, [438](#), [439f](#)
Southwestern overlay blot procedure, [438](#), [439f](#)
specialized compartments, [459](#)
specific acid–base catalysis, [59](#)
specific activity, [75](#)
specificity
 of enzymes, [57](#), [57f](#)
 of hormone receptors, [481](#), [481f](#)
 of laboratory test, [562](#), [562f](#), [563t](#)
spectrin, [651](#), [652](#), [652f](#), [652t](#), [653](#)
spectrophotofluorimetry, [563–564](#)
spectrophotometry
 enzymatic assays using, [63](#), [63f](#)
 laboratory tests using, [563–564](#)
 of porphyrins, [308](#), [310f](#)
spectroscopy, protein structures solved by, [40](#)
spermidine, [299](#), [299f](#), [300f](#)
spermine, [299](#), [299f](#), [300f](#)
spherocytosis, hereditary, [478t](#), [650t](#), [651](#), [653](#)
sphingolipidoses, [234–235](#), [235t](#)
sphingolipids, [199](#), [201f](#), [229](#)
 clinical aspects of, [234–235](#), [235t](#)
 formation of, [233–234](#), [234f](#)
 in multiple sclerosis, [234](#)
sphingomyelins, [199](#), [200f](#)
 membrane asymmetry and, [464](#), [589](#)
 in membranes, [461](#)
 synthesis of, [233–234](#), [234f](#)
sphingophospholipids, [196](#)
sphingosine, [199](#), [200f](#)
 serine conversion to, [300](#)
spina bifida, folic acid supplements for, [538](#)
spliceosome, [386–387](#)
splicing of mRNA, [386–388](#), [387f](#), [388f](#), [430](#)
spontaneous assembly, [594](#)
spontaneous chemical reactions, [69](#)
spontaneous mutations, [683](#)

squalene, in cholesterol synthesis, 250, 251*f*, 252*f*
squalene epoxidase, in cholesterol synthesis, 250, 252*f*
squalene synthetase, 251*f*
SR (serine–arginine motifs), 387
SR-B1 (scavenger receptor B1), 241*f*, 242
Src homology 2 (SH2), 508, 509*f*
SREBP (sterol regulatory element-binding protein), 252
sRNAs (small, heterogeneous regulatory RNAs), 348
SRP (signal recognition particle), 580–581, 581*f*, 629
SRP receptor (SRP-R), 580–581, 581*f*
SSBs (single-strand binding proteins), 362*f*, 363–364, 363*t*
ssDNA (single-stranded DNA), 361
staggered ends, 433, 434*f*
standard free-energy change ($\Delta G^{0'}$)
 of ATP hydrolysis, 107–108, 107*t*, 108*f*
 in biologic systems, 106
StAR (steroidogenic acute regulatory) protein, 485, 485*f*
starch, 145, 147*f*
 hydrolysis of, 520
Starling forces, 628
starvation, 105
 fatty liver and, 244
 ketosis in, 215
 metabolic pathways in, 138–139, 138*t*, 139*f*, 139*t*
 triacylglycerol redirection and, 240
statin drugs, 250, 250*f*, 257
statins, 84
STATs (signal transducers and activators of transcription), 509, 510*f*
stearic acid, 197*t*
stearoyl-CoA, 223, 223*f*
stem cell biology, 4, 446
stem cell factor, 647
stem cells
 in cancer, 696
 hematopoietic, 646–647, 647*f*
 induced pluripotent, 446
step-wise assembly, 386

stereochemical (-*sn*) numbering system, [199](#), [199f](#)
stereochemistry, of l- α -amino acids, [17](#)
stereospecificity, of enzymes, [57](#), [57f](#)
steroid sulfates, [234](#), [235](#)
steroidogenesis
 ovarian, [487–489](#), [489f](#), [490f](#)
 testicular, [487](#), [488f](#)
steroidogenic acute regulatory (StAR) protein, [485](#), [485f](#)
steroids
 cytochrome P450 in metabolism of, [115–116](#), [115f](#), [116f](#)
 lipid bilayer and, [462](#)
 metabolic pathways of, [131](#), [131f](#)
 nucleus of, [202](#), [202f](#)
 plasma transport of, [498t](#), [499](#)
 as precursor molecule, [483](#), [484f](#)
 receptors for, [482](#)
 roles of, [202](#)
 stereoisomers of, [203](#), [203f](#)
 storage of, [497](#), [497t](#)
 vitamin B₆ role in actions of, [535](#)
sterol 27-hydroxylase (CYP27A1), [255–256](#), [256f](#)
sterol regulatory element-binding protein (SREBP), [252](#)
sterols, [202](#), [461](#)
Stickler syndrome, [608](#)
sticky end ligation, [434–435](#)
sticky ends, [433](#), [434f](#)
sticky patch, in hemoglobin S, [54](#), [54f](#)
stochastic processes, mortality and aging as, [708](#)
stoichiometry, [69](#)
Stokes radii, [24–25](#)
stop codon, [403–404](#), [404f](#)
stop-transfer signal, [582](#), [583f](#)
storage granules, of platelets, [670](#)
strain, enzymatic catalysis by, [59](#)
streptokinase, [64](#), [679](#)
streptomycin, [145](#)
striated muscle, [613f](#), [616](#), [617t](#), [619](#)

strong acids, dissociation of, 10–11
strong bases, dissociation of, 10–11
structural proteins, 592. *See also* collagen; elastin; fibrillin
substrate analogs, 77, 77f
substrate cycles, in glycolysis and gluconeogenesis regulation, 176–177
substrate deprivation therapy, 235
substrate level phosphorylation, 122
substrate shuttles, mitochondrial, 125–126, 125f
substrates, 57
 anaplerotic, 153–154
 in balanced chemical equations, 69
 cellular concentrations of, 83
 conformational changes induced by, 60, 60f
 multiple, 79, 79f, 80f
 pairs of, 125, 125f
 prosthetic group, cofactor, and coenzyme interactions with, 58, 58f
 reaction rate response to concentrations of, 71, 73–74, 73f, 74f
 regulation of metabolic pathways with, 135
 for respiratory chain substrates, 150–151, 151f
succinate dehydrogenase, 114
 in citric acid cycle, 152f, 153
 inhibition of, 77, 77f
succinate thiokinase (succinyl-CoA synthetase), 152f, 153, 247, 247f
succinate-Q reductase (Complex II), 118, 119f, 120, 120f
succinic acid, pK_a of, 13t
succinic semialdehyde dehydrogenase, defects in, 303, 303f
succinyl-CoA
 in citric acid cycle, 152f, 153
 heme biosynthesis from, 305–307, 306f, 307f, 308f, 309f, 310t
succinyl-CoA synthetase (succinate thiokinase), 152f, 153, 247, 247f
succinyl-CoA-acetoacetate-CoA transferase (thiophorase), 211, 213f
 in citric acid cycle, 152f, 153
sucrose, physiological importance of, 145, 146f, 146t
sugar nucleotides, in glycoprotein synthesis, 549–550
sugars, in amphipathic lipids, 462
“suicide enzyme,” cyclooxygenase as, 224–225
suicide inhibitors, 78–79

sulfate, in glycoproteins, 547
sulfatide, 202
sulfation, of xenobiotics, 558
sulfite oxidase
 deficiency of, 100
 transition metals in, 100, 100*f*
sulfo(galacto)-glycerolipids, 234
sulfogalactosylceramide, 202
 accumulation of, 235
 synthesis of, 234
sulfonyleurea drugs, 215
sulfotransferases, 600
sumoylation, of histones, 351, 353*t*
supercoils, DNA, 341, 367, 368*f*
superoxide, 649–650
superoxide anion-free radical, 116
superoxide dismutases (SODs), 204, 649–650
 copper in, 100
 gallium toxicity to, 94
 oxygen toxicity protection by, 116, 544
 transition metals in, 96–97
supersecondary structures, 36
suppressor mutations, 398–399
suppressor tRNA, 398
supravalvular aortic stenosis, 596
surfactant, lung, 229
 deficiency of, 200, 234
SV40 enhancer, 421, 422*f*
Svedberg units, 347
symport systems, 468, 468*f*
syn conformers, 320, 321*f*
synaptic vesicles, 587
synaptobrevin, 587
5q-syndrome, 649
synthetic biology, 4
systems biology, 4, 447–449

T

T lymphocytes, [639](#), [656](#), [662](#)

T state. *See* taut state

$t_{1/2}$. *See* half-life

T₃. *See* triiodothyronine

T₄ (thyroxine). *See* tetraiodothyronine

TAFIa (thrombin-activatable fibrinolysis inhibitor), [678f](#), [679](#)

TAFs (TBP-associated factors), [380](#), [381f](#), [383–385](#)

tamoxifen, [703](#)

tandem MS (MS–MS, MS²)

metabolic disease detection with, [278](#), [280](#)

protein analysis using, [30](#)

Tangier disease, [258t](#)

TaqI, [433t](#)

target cell, [476](#), [481](#), [481t](#)

targeted gene regulation, [446–447](#)

TATA box, in transcription control

in bacteria, [379–380](#), [380f](#)

in eukaryotes, [379–381](#), [380f](#), [381f](#)

TBP binding with, [383–384](#)

TATA-binding protein (TBP), [380](#)

TATA box binding of, [383–384](#)

taurine, cysteine conversion to, [297](#), [297f](#)

taurochenodeoxycholic acid, [256f](#)

taurocholic acid, [256f](#)

taut (T) state, of hemoglobin, [50–52](#), [51f](#), [52f](#)

2,3-bisphosphoglycerate stabilization of, [53](#), [53f](#)

tautomerism, [320](#), [320f](#)

Tay-Sachs disease, [235t](#), [585t](#)

TBG (thyroxine-binding globulin), [498](#)

TBP. *See* TATA-binding protein

TBP-associated factors (TAFs), [380](#), [381f](#), [383–385](#)

TEBG (testosterone-estrogen-binding globulin), [499](#)

telomerase, [355](#), [692](#), [716](#)

telomeres, [355](#), [355f](#), [716](#), [717f](#)

temperature

in fluid mosaic model of membrane structure, 465
reaction rate response to, 70, 71*f*, 72
transition, 340, 465
temperature coefficient (Q_{10}), 72
template binding, in transcription, 376*f*
template strand DNA
in DNA replication, 339, 343, 344*f*
in RNA synthesis, 375, 375*f*, 380*f*
N-terminal signal peptide, 574, 574*f*, 580–582, 580*t*, 581*f*, 582*f*
terminal transferase, 434*t*
termination
of protein synthesis, 403–404, 404*f*
in proteoglycan synthesis, 600
in transcription cycle, 376–379, 376*f*, 383
termination protein, 378
termination signals, of translation, 394, 394*t*
tertiary structure, 36–37, 38*f*, 39*f*
of collagen, 43, 43*f*
of myoglobin and hemoglobin, 50
as order of protein structure, 34
schematic diagrams of, 38–39
stabilizing factors in, 39
testicular steroidogenesis, 487, 488*f*
testosterone
metabolism of, 487, 489*f*
plasma transport of, 498*t*, 499
synthesis of, 483, 484*f*, 485*f*, 487, 488*f*
testosterone-estrogen-binding globulin (TEBG), 499
tethering, 586–587
tetracycline (Tet) resistance genes, 437
tetrahedral geometry, of water molecules, 6, 7*f*
tetrahedral transition state intermediates, 60, 60*f*
tetrahydrofolate, 537, 537*f*
tetraiodothyronine (thyroxine; T_4)
plasma transport of, 498, 498*t*
storage of, 497, 497*t*

synthesis of, 483, 484*f*, 492, 493*f*
tetramers, histone, 351, 351*f*, 353
tetrapyrroles, in heme, 48, 48*f*, 305, 306*f*
tetroses, 141, 142*t*
 of physiological importance, 143
TF (tissue factor), 673, 673*t*, 674*t*
TFIIA, 381, 381*f*, 382*f*, 383–384
TFIIB, 381, 381*f*, 382*f*, 383–384
TFIID, 381, 381*f*, 382*f*
 components of, 384–385
 in RNA polymerase II formation, 383–384
TFIIE, 381, 381*f*, 382*f*, 383–384
TFIIF, 381, 381*f*, 382*f*, 383–384
TFIIH, 381, 381*f*, 382*f*
 CTD modification by, 384
 in RNA polymerase II formation, 383–384
TFPI (tissue factor pathway inhibitor), 673
TGN (*trans*-Golgi network), 574, 575*f*, 588
thalassemias, 54
 α -thalassemias, 650*t*
 β -thalassemias, 442, 443*f*, 650*t*
 pathologic protein conformations in, 42
thanatophoric dysplasia, 609
theobromine, 321, 323*f*
theophylline, 246, 321, 323*f*
thermodynamics, of biologic systems, 105–106
thermogenesis, 247, 247*f*
 diet-induced, 524
thermogenin, 123–124, 247, 247*f*
thiamin. *See* vitamin B₁
thiamin diphosphate, 161, 162*f*, 533–534
thick (myosin) filaments, 612–613, 613*f*
thin (actin) filaments, 612–613, 613*f*, 614*f*
thioesterase (deacylase), 218, 218*f*, 219*f*
6-thioguanine, 324, 324*f*
thiokinase. *See* acyl-CoA synthetase; succinate thiokinase
thiolase, 209, 209*f*, 211

- in mevalonate synthesis, [250](#), [250f](#)
- thiophorase (succinyl-CoA-acetoacetate-CoA transferase), [211](#), [213f](#)
 - in citric acid cycle, [152f](#), [153](#)
- thioredoxin, [332](#), [332f](#)
- thioredoxin reductase, [332](#), [332f](#)
- threonine, [15t](#)
 - carbon skeleton catabolism of, [285](#), [285f](#)
- thrombin
 - in fibrin clot formation, [672](#)
 - fibrinogen conversion to fibrin by, [675–677](#), [675f](#), [676f](#)
 - inhibition of, [677–678](#)
 - in platelet aggregation, [670](#), [671f](#)
 - prothrombin conversion to, [674–675](#), [675f](#)
 - regulation of, [677](#)
- thrombin-activatable fibrinolysis inhibitor (TAFIa), [678f](#), [679](#)
- thrombocytopenia, [646](#), [654–655](#)
- thrombomodulin, [677](#)
- thrombopoietin, [647](#)
- thrombosis, [654](#)
 - alteplase and streptokinase treatment of, [679](#)
 - anticoagulant drug effects on, [677–678](#)
 - biomedical importance of, [669](#)
 - endothelial cell actions in, [670](#), [672](#)
 - fibrin clot formation in. *See* fibrin clot formation
 - folic acid supplements for, [538](#)
 - laboratory tests for, [679](#)
 - phases of, [669](#)
 - platelet aggregation in, [670](#), [671f](#)
 - thrombi types in, [670](#)
 - thrombin inhibition in, [677–678](#)
 - thrombin regulation in, [677](#)
- thromboxane A₂ (TxA₂), [198f](#), [224](#)
 - inhibition of, [672](#)
 - in platelet aggregation, [670](#), [671f](#)
- thromboxanes (TXs), [197](#), [198](#), [198f](#), [216](#)
 - clinical significance of, [226–227](#)
 - cyclooxygenase pathway in formation of, [224](#), [226f](#)

thrombus
 formation of, [670](#), [671f](#)
 types of, [670](#)

thymidine, [322t](#)
 salvage pathways of, [333](#)

thymidine monophosphate (TMP), [322f](#), [322t](#)

thymidylate, [338–339](#)

thymine, [322t](#), [337f](#)
 base pairing in DNA, [339](#), [340f](#)
 salvage pathways of, [333](#)

thymine dimer formation and UV light, [712](#), [713f](#)

thyroglobulin, [492](#)

thyroid function tests, [567](#)

thyroid hormones
 in cholesterol synthesis, [252–253](#), [253f](#)
 in lipolysis, [246](#), [246f](#)
 plasma transport of, [498](#), [498t](#)
 receptors for, [482](#)
 regulation of gene expression by, [501](#), [501f](#)
 storage of, [497](#), [497t](#)
 synthesis of, [492](#), [493f](#)

thyroxine (T₄). *See* tetraiodothyronine

thyroxine-binding globulin (TBG), [498](#)

ticagrelor, [672](#)

tight junctions, [466](#)

tiglyl-CoA, catabolism of, [292f](#), [293f](#)

TIM (translocase of the inner membrane), [576](#)

time-of-flight (TOF) mass spectrometers, [28–29](#)

timnodonic acid, [197t](#)

tirofiban, [672](#)

tissue factor (TF), [673](#), [673t](#), [674t](#)

tissue factor pathway inhibitor (TFPI), [673](#)

tissue injury
 fibrin clot formation in, [672–673](#), [672f](#), [673f](#), [673t](#), [674t](#)
 myoglobinuria after, [54](#)
 serum enzyme analysis after, [64](#), [65f](#)

tissue nonspecific alkaline phosphatase (TNAP), [605](#)

tissue plasminogen activator (tPA), [64](#), [678f](#), [679](#)

tissues

- differentiation of, retinoic acid role in, [529–530](#)
- in fasting state, [130](#), [138–139](#), [138t](#), [139f](#), [139t](#)
- in fed state, [130](#), [136–138](#), [137f](#), [138t](#)
- glucose uptake by, [136–137](#), [137f](#)
- hypoxic, [160](#)
- metabolic pathways at level of, [132–133](#), [132f](#), [133f](#)

titration curve, for weak acids, [12](#), [12f](#)

T_m . See transition temperature

TME (tumor microenvironment), [682](#), [694–695](#), [695f](#)

TMP (thymidine monophosphate), [322f](#), [322t](#)

TNAP (tissue nonspecific alkaline phosphatase), [605](#)

tobacco, [703](#)

tocopherols. See vitamin E

tocotrienols. See vitamin E

TOF (time-of-flight) mass spectrometers, [28–29](#)

tolbutamide, [215](#), [243](#)

TOM (translocase of the outer membrane), [576](#)

topogenic sequences, [583](#)

topoisomerases, DNA, [341](#), [363t](#), [367](#), [367f](#)

total bilirubin, [313](#)

total energy expenditure, [524](#)

total iron-binding capacity, [633](#)

totipotent stem cells, [646](#)

toxic hyperbilirubinemia, [314](#)

toxicity

- of ammonia, [273–274](#)
- bilirubin, [313–314](#)
- of folic acid, [538](#)
- heavy metal, [93–94](#)
- lead, [93–94](#), [306](#), [309](#)
- micronutrient, [527](#)
- niacin, [535](#)
- oxygen. See reactive oxygen species
- of plant amino acids, [18](#), [18t](#)
- of transition metals, [94–95](#), [95t](#)

vitamin A, [530](#)
vitamin B₆, [535](#)
vitamin D, [532](#)
of xenobiotics, [559](#), [559f](#)

toxins
 botulinum B, [587](#)
 cholera, [202](#), [202f](#), [234](#), [504](#)
 diphtheria, [407](#), [472](#)
 microbial, [472](#)
 pertussis, [504](#)

tPA (tissue plasminogen activator), [64](#), [678f](#), [679](#)

TΨC arm. *See* ribothymidine pseudouridine cytidine arm

trans fatty acids, [198](#), [226](#), [462](#)

transactivator proteins, [420](#), [421f](#)

transaldolase, in pentose phosphate pathway, [183–185](#), [183f](#), [184f](#)

transaminase
 in amino acid catabolism, [281–282](#)
 vitamin B₆ assessment with, [535](#)

transamination
 in amino acid metabolism, [131](#), [132f](#), [272–273](#), [273f](#), [281](#)
 citric acid cycle role in, [153–154](#), [154f](#)
 ping-pong mechanism for, [59](#), [59f](#), [273](#), [273f](#)

transcortin, [498–499](#), [498t](#)

transcription, [341](#)
 activators and coregulators in control of, [384–385](#), [385t](#)
 bacterial promoters in, [379](#), [380f](#)
 eukaryotic promoters in, [379–381](#), [380f](#), [381f](#), [382f](#), [383](#)
 eukaryotic transcription complex, [383–386](#)
 hormone modulation of, [511–514](#), [512f](#), [513f](#), [513t](#), [514t](#)
 initiation of, [375–377](#), [376f](#), [377f](#)
 promoters in, [376](#)
 alternative, [388–389](#), [389f](#)
 protein-DNA interactions in regulation of, [414–418](#), [414f](#), [415f](#), [416f](#),
 [417f](#)
 reverse in retroviruses, [344](#), [360](#), [367–368](#)
 in RNA synthesis, [339](#)
 termination of, [383](#)

transcription complex, eukaryotic. *See* eukaryotic transcription complex

transcription control elements, [385t](#)

transcription factors, [385t](#), [717](#)
for enzyme synthesis, [84](#)

transcription start site (TSS), [376](#), [377f](#)
alternative, [430](#)

transcription unit, [376](#)

transcriptome information, [447](#)

transcriptomics, [3](#)

transcytosis, [588](#)

transdeamination, [273](#), [274f](#)

transducers, [370](#), [371f](#)

transfected cells in culture, [423](#), [424f](#)

transfer RNA (tRNA), [343](#), [374](#), [375t](#)
amino acid association with, [395–396](#), [395f](#), [396f](#)
anticodon region of, [394–396](#), [396f](#)
function of, [345–346](#)
processing of
modification and, [391](#)
precursors for, [389](#)
in protein synthesis
elongation, [402–403](#), [402f](#)
initiation, [399](#), [400f](#), [401–402](#)
termination, [403–404](#)
structure of, [346–347](#), [346f](#)
suppressor, [398](#)

transferases, [57](#)

transferrin, [523](#), [523f](#), [627](#), [632–633](#), [632t](#), [634–635](#)

transferrin cycle, [633](#), [634f](#)

transferrin receptor, [633](#), [634–635](#), [635f](#)

transgenic animal approach, [423](#)

transgenic animals, [446](#)

trans-Golgi network (TGN), [574](#), [575f](#), [588](#)

transhydrogenase, mitochondrial, [125](#)

transition metals
absorption and transport of, [101](#)
biomedical importance of, [92](#)

heavy metal toxicity and, 93–94
human requirement for, 93, 93t
Lewis acid properties of, 93
multivalent states of, 93, 94f, 94t, 95
in organometallic complexes, 95–97, 95f, 96f, 96t, 97f
oxidation of, 93, 94f, 94t
physiologic roles of, 97–101, 97f, 98f, 99f, 100f
toxicity of, 94–95, 95t

transition mutations, 396, 396f

transition state
of chemical reactions, 69–70, 70f
enzymatic stabilization of, 72

transition state analogs, 59, 76

transition state intermediates, 59, 70, 70f
acyl-enzyme, 61, 61f
tetrahedral, 60, 60f

transition state stabilization, in enzyme catalysis, 59

transition temperature (T_m), 340, 465

transketolase
in pentose phosphate pathway, 183–185, 183f, 184f
vitamin B₁ assessment with, 534

translation, 394. *See also* protein synthesis

translation termination signals, 394, 394t

translocase of the inner membrane (TIM), 576

translocase of the outer membrane (TOM), 576

translocation
in cancer, 685, 686f
into cell nucleus, 577–578, 578f
of mRNA, 578
of proteins, 576

translocation, in protein synthesis, 403

translocation complexes, 576

translocon, 580

transmembrane collagens, 594

transmembrane proteins
amino acid sequence of, 463

ion channels as, 469–471, 470*f*, 471*f*, 471*t*
transmembrane signaling, 459, 467*t*, 475–476
in cancer, 689, 689*t*
in platelet aggregation, 670, 671*f*
transport vesicles
coat proteins of, 586
definition of, 585
model of, 586–588, 586*t*, 587*f*
proteins in, 574, 575*f*
in *trans*-Golgi network, 588
transporters and transport systems
ATP in, 472–473, 472*t*
transporters involved in, 468–469, 468*f*, 468*t*, 469*f*
aquaporins, 472
ATP-binding cassette, 241*f*, 242
ATP-driven active, 472, 473*t*
facilitated diffusion, 467–468, 467*f*, 467*t*, 468*f*
hormone regulation of, 469–470
ping-pong mechanism of, 469, 469*f*
transporters involved in, 468–469, 468*f*, 468*t*, 469*f*
glucose. *See* glucose transporters
ion channels and, 468*t*
ionophores, 471–472
membrane fatty acid, 238
of membranes, 459, 463, 469–470
of mitochondria, 124–126, 124*f*, 125*f*, 126*f*
passive diffusion, 467–468, 467*f*, 467*t*, 468*f*
plasma transport proteins, 498–499, 498*t*
reverse cholesterol, 241*f*, 242, 250, 254, 254*f*, 257
simple diffusion, 467–468, 467*f*, 467*t*, 468*f*
tricarboxylate, 221
transposition, 360, 442
retrotransposons and, 357
transthyretin, 639
transverse asymmetry, 589
transverse movement, of lipids across membrane, 463–464
transversion mutations, 396, 396*f*

trauma, protein loss in, 526

trehalose, 146*f*, 146*t*

triacylglycerol

- as metabolic fuel, 130, 136
- metabolic pathways of, 131, 131*f*, 133, 133*f*
 - in fed state, 137–138, 137*f*, 138*t*

triacylglycerol synthesis, 134

- fructose effects on, 186, 188*f*, 189–190

triacylglycerols (triglycerides), 199, 199*f*

- biomedical importance of, 229
- digestion and absorption of, 520–521, 522*f*
- drugs for reduction of serum levels of, 257
- in lipoprotein core, 237–238, 238*f*
- metabolism of
 - in adipose tissue, 244–245, 245*f*
 - fatty liver and, 243–244
 - hepatic, 242–243, 243*f*
 - high-density lipoproteins in, 241–242, 241*f*
 - hydrolysis in, 229
- perilipin and, 247
- synthesis of, 230–232, 230*f*, 231*f*
- transport of, 238–239, 239*f*, 240*f*

tricarboxylate transporter, 221, 221*f*

tricarboxylic acid cycle. *See* citric acid cycle

triglycerides. *See* triacylglycerols

triiodothyronine (T₃)

- plasma transport of, 498, 498*t*
- storage of, 497, 497*t*
- synthesis of, 483, 484*f*, 492, 493*f*

trimeric G complex, 504

trimethoprim, 537

trimethylxanthine, 321, 323*f*

trinucleotide repeats, 358

triokinase, 186, 188*f*

triose phosphate isomerase, structure of, 37*f*

trioses, 141, 142*t*

- of physiological importance, 143

tripeptidases, 521
triple helix, of collagen structure, 43, 43f
triplet codes, 394, 394t
triskelion, 475
tRNA. *See* transfer RNA
tRNA amino acid charging, 395, 395f
tropocollagen, 43, 43f, 594
tropoelastin, 596
tropomyosin, 614–615, 614f
troponin complex, 615
troponins, 614–615, 614f
 cardiac, 64
true-positive result, 562
trypsin, 521
 covalent catalysis of, 61
 for cystic fibrosis, 64
trypsinogen, 521
tryptophan, 16t
 carbon skeleton catabolism of, 286–288, 289f, 290f
 deficiency of, 534–535
 permeability coefficient of, 463f
 specialized products of, 300, 301f
 ultraviolet light absorption by, 20, 20f
tryptophan 2,3-dioxygenase (tryptophan pyrrolase), 286–288, 289f
l-tryptophan dioxygenase, 115
t-SNARE proteins, 586–588, 587f
TSS. *See* transcription start site
T-tubular system, 619
 α -tubulin, 624, 625f
 β -tubulin, 624, 625f
 γ -tubulin, 624
tumor biomarkers, 700–701, 701t
tumor microenvironment (TME), 682, 694–695, 695f
tumor progression, 688
tumor suppressor genes, 685–688, 685t, 686f, 687f, 687t, 688f, 688t
 early studies on, 2
 p53, 372

tumor viruses, [684–685](#), [684t](#), [686f](#), [703](#)

tumors

- benign, [681](#)
- malignant. *See* cancer

turnover, protein, [84](#), [269–270](#)

turnover number, [75](#)

turns, in proteins, [36](#), [37f](#)

twin lamb disease, [215](#), [244](#)

twisted gastrulation 1 (TWSG1), [635](#)

two-dimensional electrophoresis, protein purity assessment with, [26](#), [27f](#)

two-hybrid interaction test, [447](#), [449f](#)

TWSG1 (twisted gastrulation 1), [635](#)

TxA₂. *See* thromboxane A₂

TXs. *See* thromboxanes

type 1 leukocyte adhesion deficiency, [658–659](#)

type 2 diabetes, [172](#)

type A response, in gene expression, [410–411](#), [410f](#)

type B response, in gene expression, [410f](#), [411](#)

type C response, in gene expression, [410f](#), [411](#)

type I collagen, [604–605](#), [605t](#)

type I hyperprolinemia, [282](#), [282f](#)

type I tyrosinemia, [286](#), [287f](#)

type II collagen, [607](#), [608f](#)

type II hyperprolinemia, [282](#), [282f](#), [285f](#), [286](#)

type II tyrosinemia, [286](#), [287f](#)

type IV collagen, [595–596](#)

type IX collagen, [595](#)

type V collagen, [604](#)

type VII collagen, [596](#)

tyrosinase, copper in, [98–100](#)

tyrosine, [15t–16t](#)

- carbon skeleton catabolism of, [286](#), [287f](#)
- hormone synthesis from, [483](#), [484f](#), [491–492](#), [491f](#), [493f](#)
- specialized products of, [300](#), [302f](#)
- synthesis of, [266](#), [267f](#)
- ultraviolet light absorption by, [20](#), [20f](#)

tyrosine aminotransferase, [286](#), [287f](#)

tyrosine hydroxylase, [491](#), [491f](#)
tyrosine kinases, inhibitors of, [701](#)
tyrosinosis, [286](#), [287f](#)
tyrosinyl-tRNA, [407](#), [407f](#)

U

UAS (upstream activator sequence), [427](#)
ubiquinone. *See* coenzyme Q
ubiquitin
 protein degradation dependent on, [270–271](#), [270f](#), [271f](#)
 structure of, [270](#), [270f](#)
ubiquitin and protein degradation, [584–585](#), [585f](#)
ubiquitin-proteasome pathway, enzyme degradation by, [84–85](#), [270–271](#),
 [270f](#), [271f](#)
UCP1 (uncoupling protein 1), [247](#), [247f](#)
UDPGal (uridine diphosphate galactose), [187–188](#), [189f](#)
UDPGal 4-epimerase, [187–188](#), [189f](#)
UDPGlc. *See* uridine diphosphate glucose
UDPGlc dehydrogenase, in uronic acid pathway, [186–187](#), [187f](#)
UDPGlc pyrophosphorylase
 in glycogenesis, [164](#), [165f](#)
 in uronic acid pathway, [186–187](#), [187f](#)
ulcers, [519](#), [555](#)
ultimate carcinogens, [684](#)
ultraviolet light (UV), [712](#), [713f](#)
 amino acid absorption of, [20](#), [20f](#)
 carcinogenic effect of, [683](#), [683t](#)
 DNA damage caused by, [370f](#), [370t](#)
 nucleotide absorption of, [321](#)
UMP (uridine monophosphate), [322f](#), [322t](#)
unambiguity, of genetic code, [394](#), [394t](#)
unconjugated hyperbilirubinemia, [313t](#), [314](#)
uncouplers, [123–124](#), [525](#)
uncoupling protein 1 (UCP1), [247](#), [247f](#)
undernutrition, [519](#), [524–525](#), [524f](#)
unequal crossover, [359](#), [360f](#)
unesterified fatty acids. *See* free fatty acids

unfolded protein response (UPR), 584
Union of Biochemistry (IUB), enzyme nomenclature system of, 57
uniport systems, 468, 468*f*
unipotent stem cells, 646
unique-sequence (nonrepetitive) DNA, 357
universality of genetic code, 394*t*, 395
unsaturated fatty acids, 196, 196*f*, 197–198, 197*t*
 cis double bonds in, 198, 198*f*
 dietary, cholesterol levels affected by, 257
 eicosanoids formed from, 216, 224, 225*f*, 226*f*
 essential, 222, 222*f*
 abnormal metabolism of, 226
 deficiency of, 224
 prostaglandin production and, 216
 in membranes, 461–462, 461*f*, 462*f*
 oxidation of, 210, 211*f*
 structures of, 222*f*
 synthesis of, 223–224, 223*f*
UPR (unfolded protein response), 584
upstream activator sequence (UAS), 427
uracil, 322*t*, 337*f*
 base pairing in RNA, 342, 343*f*
 deoxyribonucleosides of, in pyrimidine synthesis, 332–333
 in RNA synthesis, 375
uraciluria-thyminuria, 327–328, 336
urate, as antioxidant, 204
urea
 laboratory tests for, 566
 metabolic pathways of, 131, 133
 nitrogen excretion as, 272, 275, 275*f*
 permeability coefficient of, 463*f*
 synthesis of, 272–273, 272*f*, 273*f*, 275–276, 275*f*
 active enzymes, 722*t*
 defects of, 276–278, 277*t*
 regulation of, 276
urease, transition metals in, 97, 97*f*
ureotelic animals, 272

uric acid, [321](#), [323f](#)
fructose effects on, [189–190](#)
nitrogen excretion as, [272](#)
purine catabolism to, [334](#), [335f](#)

uricase, [334](#)

uricemia, [336t](#)

uricotelic animals, [272](#)

uridine, [321f](#), [322t](#), [333](#)

uridine diphosphate galactose (UDPGal), [187–188](#), [189f](#)

uridine diphosphate glucose (UDPGlc)
in glycogenesis, [164–165](#), [165f](#)
in uronic acid pathway, [186–187](#), [187f](#)

uridine monophosphate (UMP), [322f](#), [322t](#)

uridyl transferase, deficiency of, [191](#)

urinalysis, [566](#)

urine
bilirubin in, [313](#), [315](#), [315t](#)
glucose in, [180](#)
myoglobin in, [54](#)
urobilinogen in, [315](#), [315t](#)
xylulose in, [189](#)

urine samples, [563](#)

urobilinogen, [313](#), [315](#), [315t](#)

urobilins, [313](#)

urocanic aciduria, [282](#)

urokinase, [678f](#), [679](#)

uronic acid, [599](#)

uronic acid pathway
deficiency of, [182](#)
disruption of, [189](#)
reactions of, [186–187](#), [187f](#)

uronic acids, in glycosaminoglycans, [147](#)

uroporphyrinogen decarboxylase, [307](#), [307f](#), [308f](#), [309f](#), [310t](#)

uroporphyrinogen I, in heme synthesis, [306](#), [307f](#), [308f](#), [309f](#)

uroporphyrinogen I synthase, [306](#), [307f](#), [308f](#), [309f](#)
deficiency in, [310](#), [310t](#)

uroporphyrinogen III, in heme synthesis, [306–307](#), [307f](#), [308f](#), [309f](#)

uroporphyrinogen III synthase, [306](#), [307f](#), [308f](#), [309f](#)
deficiency in, [310](#), [310t](#)
UV. *See* ultraviolet light

V

vaccines, anticancer, [703](#)
valence states, of transition metals, [93](#), [94f](#), [94t](#), [95](#)
valeric acid, [197t](#)
validity, of laboratory tests, [561–563](#), [561f](#), [562f](#), [563t](#)
valine, [15t](#)
 carbon skeleton catabolism of, [288](#), [290](#), [292f](#), [293](#), [293f](#), [293t](#)
 synthesis of, [266–267](#)
valinomycin, [125](#), [471–472](#)
valproic acid, [690](#)
van der Waals forces, [8](#), [8f](#), [339–340](#)
vanadium
 absorption of, [101](#)
 human requirement for, [93](#), [93t](#)
 multivalent states of, [93](#), [94f](#), [94t](#)
 physiologic roles of, [100–101](#)
variable numbers of tandem repeats (VNTRs), [445](#), [549](#)
variant form of Creutzfeldt-Jakob disease (vCJD), [42](#)
vascular endothelial growth factor (VEGF), [697](#)
vasodilators, [611](#), [622–623](#), [624f](#)
vCJD (variant form of Creutzfeldt-Jakob disease), [42](#)
vector cloning, [436–437](#), [437t](#)
VEGF (vascular endothelial growth factor), [697](#)
velocity, enzyme. *See* initial velocity; maximal velocity
very-low-density lipoproteins (VLDLs), [133](#), [138](#), [237t](#)
 atherosclerosis and, [257](#)
 fatty liver and, [244](#)
 fructose effects on, [186](#), [188f](#), [189–190](#)
 hepatic secretion of, [242–243](#), [243f](#)
 in ketogenesis regulation, [214](#)
 in lipid transport, [236–237](#)
 metabolism of, [240–241](#), [240f](#)
 remnants, [241](#), [254](#)

in triacylglycerol transport, [238–239](#), [239f](#), [240f](#)

vesicles

- in cell-cell communication, [476–478](#), [477f](#)
- coat proteins and, [583](#), [586–587](#), [586t](#), [587f](#)
- in endocytosis, [474](#)
- extracellular, [476–478](#), [477f](#)
- processing within, [588](#)
- secretory, [574](#), [575f](#)
- synaptic, [587](#)
- targeting of, [587](#), [587f](#)
- transport. *See* transport vesicles
- types and functions, [586t](#)

v_i . *See* initial velocity

Villefranche classification, [595](#), [596t](#)

vimentins, [625](#), [625t](#)

vinblastine, [625](#)

viral RNA–dependent DNA polymerase, [344](#)

viral SV40 enhancer, [421](#), [422f](#)

viruses

- chromosomal integration with, [359–360](#), [360f](#)
- cyclophilins in, [42](#)
- glycans in binding of, [555](#)
- host cell protein synthesis by, [405–406](#), [406f](#)
- receptor-mediated endocytosis and, [475](#)
- RNA in, [344](#)
- tumor, [684–685](#), [684t](#), [686f](#), [703](#)

vision, vitamin A function in, [529](#), [530f](#)

vitamin A (retinol)

- deficiency of, [528t](#), [530](#)
- functions of, [528t](#), [529–530](#), [530f](#)
- structure of, [529](#), [529f](#)
- toxicity of, [530](#)

vitamin B complex

- citric acid cycle need for, [153](#)
- prosthetic groups, cofactors, and coenzymes derived from, [58](#), [58f](#)

vitamin B₁ (thiamin)

- citric acid cycle need for, 153
 - coenzymes derived from, 58
 - deficiency of, 161, 163, 528*t*, 534
 - functions of, 528*t*, 533–534
 - pentose phosphate pathway need for, 185
 - structure of, 533, 533*f*
- vitamin B₂ (riboflavin)
- citric acid cycle need for, 153
 - coenzymes derived from, 58
 - deficiency of, 42, 528*t*, 534
 - flavin groups formed from, 112, 114
 - functions of, 528*t*, 534
 - measurement of, 189
- vitamin B₆ (pyridoxine, pyridoxal, pyridoxamine)
- in aminotransferases, 273, 273*f*, 535
 - deficiency of, 288, 290*f*, 528*t*, 535
 - functions of, 528*t*, 535
 - structure of, 535, 535*f*
 - toxicity of, 535
- vitamin B₁₂ (cobalamin)
- absorption of, 101, 536
 - cobalt in, 98
 - deficiency of, 528*t*, 536–538, 536*f*
 - functions of, 528*t*, 536, 536*f*
 - structure of, 536, 536*f*
- vitamin C (ascorbic acid)
- as antioxidant, 204, 544, 544*f*
 - in bile acid synthesis, 256*f*
 - in collagen synthesis, 43
 - deficiency of, 43, 263, 266, 528*t*, 540, 596
 - functions of, 528*t*, 539
 - higher intakes of, 540
 - human requirement for, 182, 186
 - iron absorption and, 523–524
 - as pro-oxidant, 544, 544*t*
 - structure of, 539, 539*f*

- vitamin D (calciferol), 528
 - as calcitriol precursor, 489
 - calcium absorption and, 523
 - in calcium homeostasis, 531
 - cholesterol as precursor for, 249
 - deficiency of, 528*t*, 531–532
 - ergosterol as precursor for, 203, 203*f*
 - functions of, 528*t*
 - hormone nature of, 530–531, 531*f*
 - synthesis and metabolism of, 530–531, 531*f*
 - toxicity of, 532
- vitamin D₃ (cholecalciferol), 530, 531*f*
 - as antioxidant, 203
 - formation and hydroxylation of, 489–491, 490*f*
- vitamin D-binding protein, 490
- vitamin E (tocopherols, tocotrienols)
 - as antioxidant, 204, 532, 544, 544*f*
 - deficiency of, 528*t*, 532
 - fatty liver and, 244
 - functions of, 528*t*, 532
 - as pro-oxidant, 545
 - structure of, 532, 532*f*
- vitamin K
 - deficiency of, 528*t*, 533
 - functions of, 528*t*, 532–533, 533*f*
 - structure of, 532–533, 533*f*
- vitamin K-dependent carboxylation, of coagulation factors, 677–678
- vitamins
 - biomedical importance of, 527
 - digestion and absorption of, 523–524
 - for health maintenance, 3
 - laboratory tests for, 564–565
 - lipid- (fat-) soluble, 196
 - lipid-soluble or water-soluble classification of, 527, 528*t*
 - nutritional requirements for, 527–528
- VLDL receptor, 238, 240
- VLDLs. *See* very-low-density lipoproteins

V_{\max} . See maximal velocity
VNTRs (variable numbers of tandem repeats), 445, 549
voltage-gated channels, 470, 471, 471*f*, 618
voltage-gated K^+ channel (HvAP), 471, 471*f*
von Gierke disease, 166, 167*t*, 335
von Willebrand disease, 585*t*, 655, 678
von Willebrand factor, 678
 in platelet aggregation, 670, 671*f*
vorinostat, 690
v-SNARE proteins, 586–588, 587*f*

W

Warburg effect, 695–696, 697*f*, 698*t*
warfarin, 532–533
 drug interactions of, 557
 mechanism of, 677–678
water
 as biologic solvent, 6–7, 7*f*
 biomedical importance of, 6
 biomolecule interactions with, 7–8, 7*t*, 8*f*
 body compartmentalization of, 460, 460*t*
 dipole formation by, 6–7, 7*f*
 dissociation of, 9–10
 for health maintenance, 3
 hydrogen bonding of, 7, 7*f*
 hydrogen ions in, 9–13, 12*f*, 13*t*
 hydrolysis reactions of, 9
 as nucleophile, 8–10
 permeability coefficient of, 463*f*
 pH of, 10
 respiratory chain production of, 120–121
 tetrahedral geometry of, 6, 7*f*
water channels, 472
water-miscible lipoproteins, 236
water-soluble hormones, 482, 483*t*
water-soluble molecules, 462
water-soluble vitamins, 527, 528*t*

Watson-Crick base pairing, 339, 340*f*
waxes, 196
weak acids
 amino acids as, 18–20, 19*f*, 20*t*
 buffering actions of, 12–13, 12*f*
 dissociation of, 10–12
 as functional groups, 11–12
 Henderson-Hasselbalch equation describing behavior of, 12, 12*f*
 medium properties affecting, 13
 molecular structure effects on, 13, 13*t*
 p*K*_a of, 11–13, 12*f*, 13*t*, 19
weak bases
 buffering actions of, 12–13, 12*f*
 dissociation of, 10–12
wear and tear theories of aging
 free radicals, 710, 712
 hydrolytic reactions, 708–709, 709*f*
 mitochondria and, 710, 712
 molecular repair mechanisms and, 713–715
 protein glycation, 712–713, 714*f*
 reactive oxygen species, 709–710, 710*f*, 711*f*
 ultraviolet radiation, 712, 713*f*
weight loss, low carbohydrate diets for, 181
Wernicke encephalopathy, 534
Western protein blot procedure, 438, 439*f*
white blood cells
 biomedical importance of, 656
 integrins in, 658–659, 659*t*
 multiple types of, 656–657, 657*f*
 phagocytosis, 474, 656, 657, 659–661, 659*f*, 660*t*
 production regulation of, 657
white thrombus, 670
Williams-Beuren syndrome, 596
Wilson disease, 298, 478*t*, 627, 634
wobble, 396

X

xanthine, [321](#), [323f](#)
xanthine oxidase, [112](#)
 deficiency of, hypouricemia and, [335](#)
 molybdenum in, [100](#)
xanthurenate, [288](#), [290f](#)
X-chromosome pair, [354](#)
xenobiotics
 biomedical importance of, [556](#)
 metabolism of
 acetylation and methylation, [558–559](#)
 conjugation, [558](#)
 hydroxylation by cytochrome P450, [556–558](#)
 toxic, immunologic, and carcinogenic effects of, [559](#), [559f](#)
 types of, [556](#)
xerophthalmia, [530](#)
X-linked disorders, [445](#)
x-ray crystallography, [39–40](#)
x-rays, carcinogenic effect of, [683](#), [683t](#)
xylose, [144f](#), [144t](#), [548t](#)
xylulose, [144f](#), [144t](#), [189](#)
xylulose 5- phosphate, [185](#)

Y

YAC (yeast artificial chromosome) vector, [437](#), [437t](#)
yeast, fermentation by cell-free extract of, [1–2](#)
yeast artificial chromosome (YAC) vector, [437](#), [437t](#)
yeast Flp recombinase, [435](#)
yeast FRT sites, [435](#)

Z

Z line, [612](#), [612f](#), [613f](#)
Zellweger (cerebrohepato renal) syndrome, [215](#), [579–580](#), [580t](#)
zinc
 absorption of, [101](#)
 human requirement for, [93](#), [93t](#)
 multivalent states of, [93](#), [94f](#), [94t](#)
 physiologic roles of, [98](#), [99f](#)

toxicity of, [95t](#)
zinc finger, [98](#)
 structure of, [95f](#)
zinc finger motif, [426](#), [426f](#)
zona pellucida, [553](#)
zwitterions, [19](#)
zymogens, [87](#), [627](#)
 protease secretion as, [521](#)

目录

Title Page	2
Copyright Page	4
Contents	9
Preface	17
SECTION I Structures & Functions of Proteins & Enzymes	21
1 Biochemistry & Medicine	21
2 Water & pH	31
3 Amino Acids & Peptides	53
4 Proteins: Determination of Primary Structure	74
5 Proteins: Higher Orders of Structure	98
SECTION II Enzymes: Kinetics, Mechanism, Regulation, & Role of Transition Metals	134
6 Proteins: Myoglobin & Hemoglobin	134
7 Enzymes: Mechanism of Action	156
8 Enzymes: Kinetics	188
9 Enzymes: Regulation of Activities	223
10 The Biochemical Roles of Transition Metals	247
SECTION III Bioenergetics	277
11 Bioenergetics: The Role of ATP	277
12 Biologic Oxidation	292
13 The Respiratory Chain & Oxidative Phosphorylation	308
SECTION IV Metabolism of Carbohydrates	336
14 Overview of Metabolism & the Provision of Metabolic Fuels	336
15 Carbohydrates of Physiological Significance	363
16 The Citric Acid Cycle: The Central Pathway of Carbohydrate, Lipid, & Amino Acid Metabolism	382
17 Glycolysis & the Oxidation of Pyruvate	397
18 Metabolism of Glycogen	412
19 Gluconeogenesis & the Control of Blood Glucose	429

20 The Pentose Phosphate Pathway & Other Pathways of Hexose Metabolism	452
SECTION V Metabolism of Lipids	483
21 Lipids of Physiologic Significance	483
22 Oxidation of Fatty Acids: Ketogenesis	512
23 Biosynthesis of Fatty Acids & Eicosanoids	535
24 Metabolism of Acylglycerols & Sphingolipids	564
25 Lipid Transport & Storage	581
26 Cholesterol Synthesis, Transport, & Excretion	611
SECTION VI Metabolism of Proteins & Amino Acids	643
27 Biosynthesis of the Nutritionally Nonessential Amino Acids	643
28 Catabolism of Proteins & of Amino Acid Nitrogen	661
29 Catabolism of the Carbon Skeletons of Amino Acids	687
30 Conversion of Amino Acids to Specialized Products	726
31 Porphyrins & Bile Pigments	749
SECTION VII Structure, Function, & Replication of Informational Macromolecules	783
32 Nucleotides	783
33 Metabolism of Purine & Pyrimidine Nucleotides	801
34 Nucleic Acid Structure & Function	827
35 DNA Organization, Replication, & Repair	855
36 RNA Synthesis, Processing, & Modification	911
37 Protein Synthesis & the Genetic Code	955
38 Regulation of Gene Expression	992
39 Molecular Genetics, Recombinant DNA, & Genomic Technology	1051
SECTION VIII Biochemistry of Extracellular & Intracellular Communication	1120
40 Membranes: Structure & Function	1120
41 The Diversity of the Endocrine System	1174
42 Hormone Action & Signal Transduction	1224
SECTION IX Special Topics (A)	1270
43 Nutrition, Digestion, & Absorption	1270

44 Micronutrients: Vitamins & Minerals	1289
45 Free Radicals & Antioxidant Nutrients	1324
46 Glycoproteins	1335
47 Metabolism of Xenobiotics	1358
48 Clinical Biochemistry	1368
SECTION X Special Topics (B)	1403
49 Intracellular Traffic & Sorting of Proteins	1403
50 The Extracellular Matrix	1448
51 Muscle & the Cytoskeleton	1491
52 Plasma Proteins & Immunoglobulins	1529
53 Red Blood Cells	1575
54 White Blood Cells	1601
SECTION XI Special Topics (C)	1629
55 Hemostasis & Thrombosis	1629
56 Cancer: An Overview	1656
57 The Biochemistry of Aging	1721
58 Biochemical Case Histories	1748
The Answer Bank	1776
Index	1792